

AMMP-6442

37- 40 GHz, 1W Linear Power Amplifier
in SMT Package

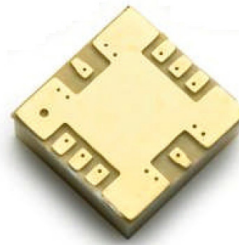

Data Sheet



Description

The AMMP-6442 MMIC is a 1W linear power amplifier in a surface mount package designed for use in transmitters that operate at frequencies between 37GHz and 40GHz. In the operational band, it provides 30dBm of output power (P-1dB) and 23dB of small-signal gain. This PA is also designed for high linear applications with typical performance of 36dBm OIP3 at 18dBm SCL output.

Applications

- Point-to-Point Radio Systems
- mmW Communications

Package Diagram

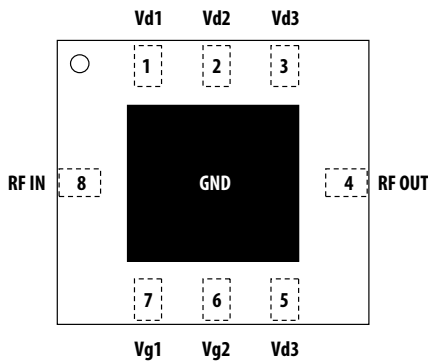

Note:

1. This MMIC uses depletion mode pHEMT devices. Negative supply is used for DC gate biasing.

Features

- 5x5mm SMT package
- 1 watt output power
- 50 Ω match on input and output
- ESD protection (50V MM, and 250V HBM)

Typical Performance (Vdd = 5V, Id(q) = 0.7A)

- Frequency range 37 to 40 GHz
- Small signal Gain of 23dB (Typ.)
- Output power @P-1 of 30dBm (Typ.)
- Input and Output return losses -8dB
- OIP3 of 35dBm @Po=18dBm (scl)

Functional Block Diagram

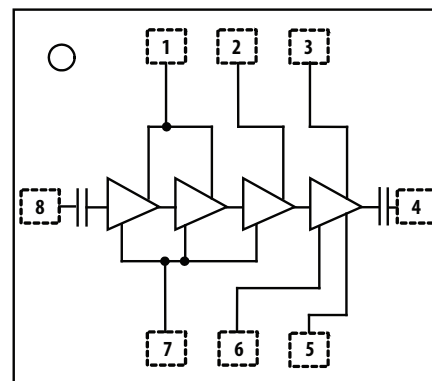

Pin	Function
1	Vd1
2	Vd2
3	Vd3
4	RF OUT
5	Vg3
6	Vg2
7	Vg1
8	RF IN



Attention: Observe Precautions for handling electrostatic sensitive devices.

ESD Machine Model (Class A): 50V
ESD Human Body Model (Class 1A): 250V

Refer to Avago Application Note A004R:
Electrostatic Discharge Damage and Control.

Note: MSL Rating = Level 2A

Electrical Specifications

1. Small/Large -signal data measured in a fully de-embedded test fixture form TA = 25°C.
2. Pre-assembly into package performance verified 100% on-wafer per AMMC-6442 published specifications.
3. This final package part performance is verified by a functional test correlated to actual performance at one or more frequencies.
4. Specifications are derived from measurements in a 50 Ω test environment. Aspects of the amplifier performance may be improved over a more narrow bandwidth by application of additional conjugate, linearity, or low noise (Γopt) matching.
5. The Gain and P1dB tested at 37GHz and 40GHz guaranteed with measurement accuracy +/-1.5dB for gain and +/- 1.6dB for P1dB.

Table 1. RF Electrical Characteristics

TA=25°C, Vdd=5.0V, Idq=0.7V, Vg=-1V, Zo=50 Ω

Parameter	Min	Typ.	Max	Unit
Operational Frequency, Freq	37		40	GHz
Small-signal Gain, Gain	20	23		dB
Output Power at 1dB Gain Compression, P-1dB	28	30		dBm
Relative Third Order Inter-modulation level (Δf=10MHz, Po=+12dBm, SCL), IM3		36		dBc
Input Return Loss, RLin		8		dB
Output Return Loss, RLout		8		dB
Reverse Isolation, Isolation		45		dB

Table 2. Recommended Operating Range

1. Ambient operational temperature TA = 25°C unless otherwise noted.
2. Channel-to-backside Thermal Resistance (Tchannel (Tc) = 34°C) as measured using infrared microscopy. Thermal Resistance at backside temperature (Tb) = 25°C calculated from measured data.

Description	Min.	Typical	Max.	Unit	Comments
Drain Supply Current, Idq		700		mA	Vdd = 5V, Vg set for Idq Typical
Gate Supply Operating Voltage, Vg	-1.3	-1	-0.7	V	Idq=700mA

Table 3. Thermal Properties

Parameter	Test Conditions	Value
Channel Temperature, T _{ch}		T _{ch} =150 °C
Thermal Resistance ^[1] (Channel-to-Base Plate), θ_{ch-bs}	Ambient operational temperature T _A = 25°C Channel-to-backside Thermal Resistance T _{channel} (T _c)=34°C Thermal Resistance at backside temperature T _b =25°C	$\theta_{JC} = 17 \text{ }^\circ\text{C/W}$

Note:

1. Assume AnPb soldering to an evaluation RF module at 90.5 °C base plate temperatures.

Absolute Minimum and Maximum Ratings

Table 4. Minimum and Maximum Ratings ^[1]

Description Pin	Min.	Max.	Unit	Comments
Drain Supply Voltage, V _d ^[2]		5.5	V	
Gate Supply Voltage, V _g	-2	0		
Power Dissipation, P _d ^[2,3]		6		
CW Input Power, P _{in} ^[2]		20	dBm	CW
Channel Temperature ^[4,5]		+150	°C	
Storage Temperature	-65	+155	°C	
Maximum Assembly Temperature		+260	°C	30 second maximum

Notes:

1. Operation in excess of any one of these conditions may result in permanent damage to this device.
2. Combinations of supply voltage, drain current, input power, and output power shall not exceed PD.
3. These ratings apply to each individual FET
4. The operating channel temperature will directly affect the device MTTF. For maximum life, it is recommended that junction temperatures be maintained at the lowest possible levels.

Typical Performance (Data was obtained from a 2.4mm connector based test fixture and includes connector and board losses. Connector and board loss is approximately 0.75dB at input and output ports for an approximate total of 1.5dB.)

($T_A = 25^\circ\text{C}$, $V_{dd} = 5\text{V}$, $I_{d(q)} = 0.7\text{A}$, $V_g = -1\text{V}$, $Z_{in} = Z_{out} = 50\ \Omega$)

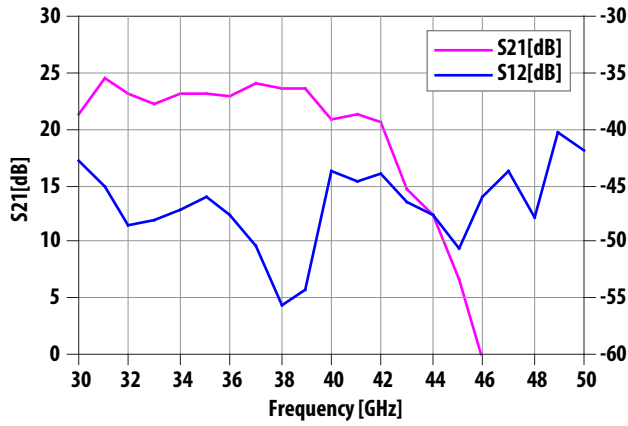

Figure 1. Typical gain and reverse Isolation

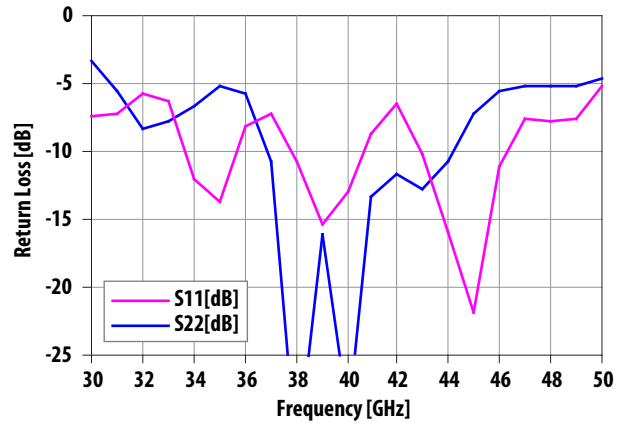

Figure 2. Typical return Loss (input and output)

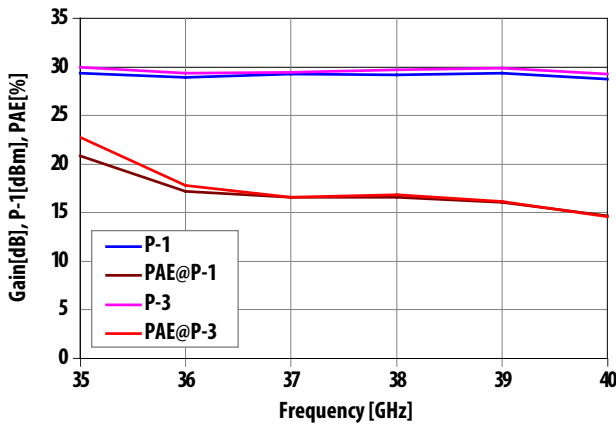

Figure 3. Typical output power (P-1 and P-3) vs. frequency

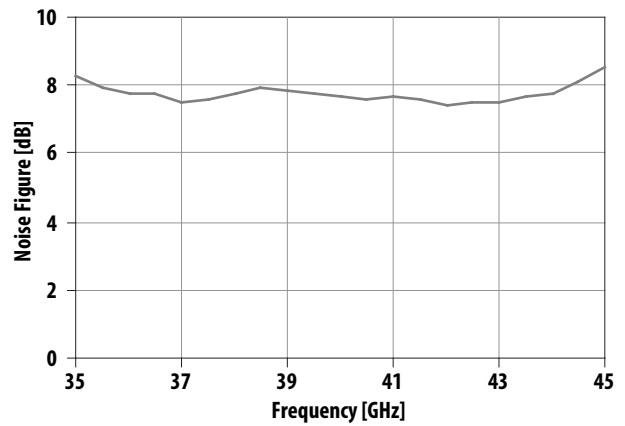

Figure 4. Typical noise figure

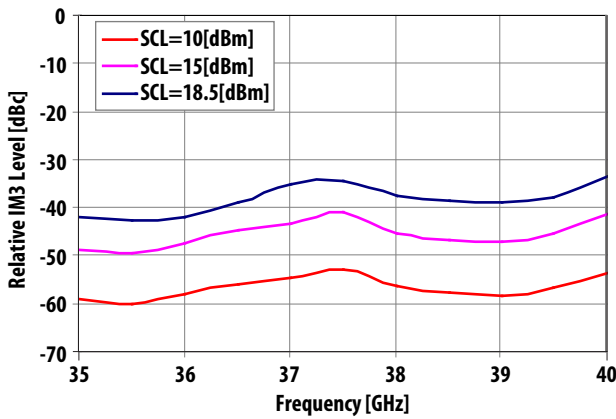

Figure 5. Typical third order inter-modulation product level vs. frequency at different single carrier output level (SCL)

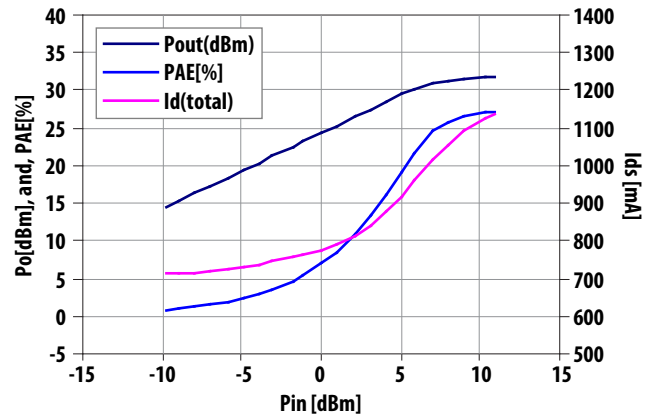

Figure 6. Typical output power, PAE, and total drain current versus Input power at 38GHz

Typical over temperature dependencies

($T_A = 25^\circ\text{C}$, $V_{dd} = 5\text{V}$, $I_{dq} = 0.7\text{A}$, $V_g = -1\text{V}$, $Z_{in} = Z_{out} = 50\ \Omega$)

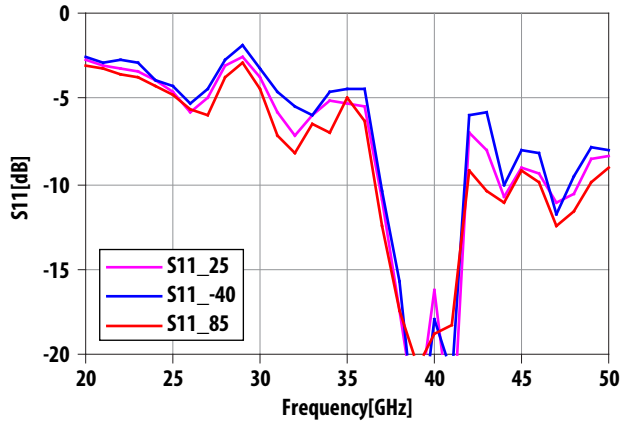

Figure 7. Typical S11 over temperature

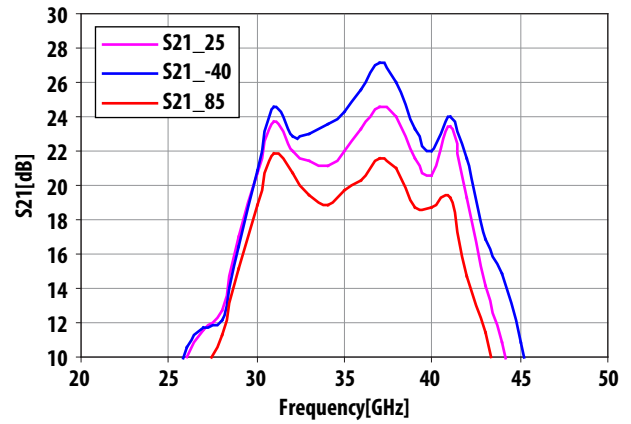

Figure 8. Typical Gain over temperature

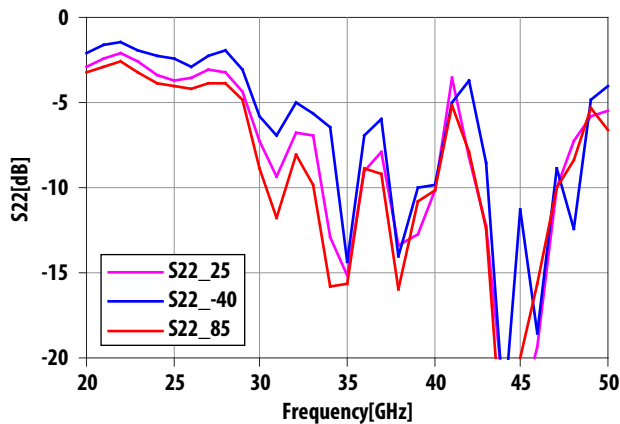

Figure 9. Typical S22 over temperature

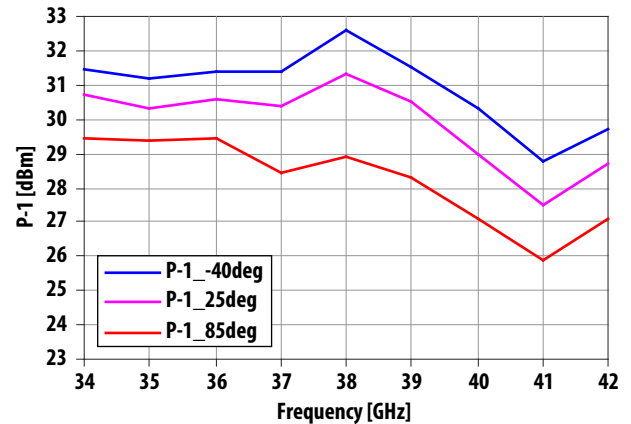

Figure 10. Typical P1 over temperature

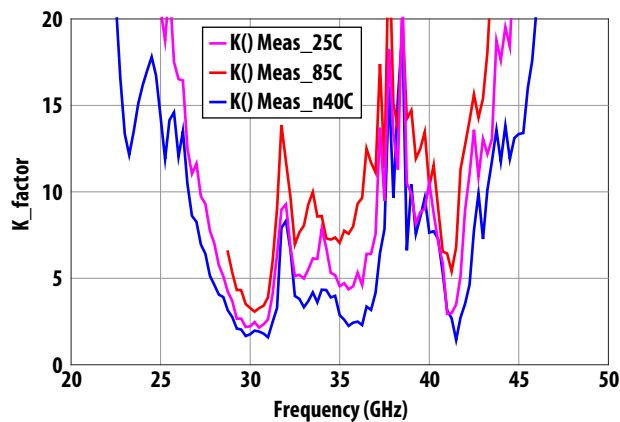

Figure 11. Typical K-factor over temperature

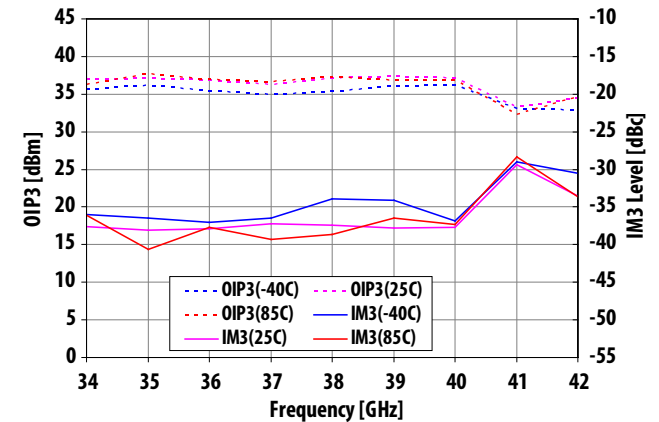

Figure 12. Typical IM3 level over temperature at $P_o=18\text{dBm}$, SCL

Typical Scattering Parameters [1], ($T_A = 25^\circ\text{C}$, $V_{d_d} = 5\text{ V}$, $I_{d_q} = 0.7\text{ A}$, $Z_{in} = Z_{out} = 50\ \Omega$)

Freq	S11 [dB]	S11 Mag.	S11 Ang.	S21 [dB]	S21 Mag.	S21 Ang.	S12 [dB]	S12 Mag.	S12 Ang.	S22 [dB]	S22 Mag.	S22 Ang.
20	-2.90	0.72	164.53	-23.81	0.06	-141.01	-48.88	3.60E-03	-57.97	-2.69	0.73	21.40
21	-3.00	0.71	86.65	-15.74	0.16	115.71	-52.28	2.43E-03	-104.05	-2.41	0.76	-70.16
22	-3.08	0.70	4.08	-7.22	0.44	0.83	-45.40	5.37E-03	152.36	-2.25	0.77	-161.69
23	-3.18	0.69	-87.20	0.27	1.03	-131.23	-46.50	4.73E-03	103.80	-2.68	0.73	112.41
24	-3.62	0.66	176.98	4.45	1.67	92.82	-48.17	3.90E-03	-13.03	-3.39	0.68	32.65
25	-4.52	0.59	84.30	7.24	2.30	-36.02	-48.90	3.59E-03	-66.94	-3.55	0.66	-45.60
26	-5.00	0.56	-8.28	9.35	2.93	-154.65	-50.90	2.85E-03	-147.71	-2.98	0.71	-125.74
27	-4.11	0.62	-104.27	11.05	3.57	81.71	-48.42	3.79E-03	176.54	-2.72	0.73	155.15
28	-3.00	0.71	168.96	13.11	4.52	-26.13	-48.48	3.77E-03	100.75	-3.20	0.69	77.20
29	-2.20	0.78	90.69	16.36	6.57	-143.75	-44.95	5.66E-03	16.82	-4.92	0.57	-11.91
30	-3.25	0.69	7.32	21.27	11.57	95.82	-42.75	7.28E-03	-67.62	-7.33	0.43	-126.78
31	-5.62	0.52	-81.47	24.48	16.76	-48.77	-45.14	5.53E-03	-173.22	-7.23	0.44	132.40
32	-8.31	0.38	151.65	23.09	14.27	172.96	-48.44	3.78E-03	113.12	-5.77	0.51	54.23
33	-7.80	0.41	55.51	22.16	12.83	59.22	-48.10	3.94E-03	83.43	-6.33	0.48	-12.99
34	-6.69	0.46	-3.34	23.03	14.18	-64.46	-47.20	4.36E-03	14.73	-12.04	0.25	-100.71
35	-5.11	0.56	-64.50	23.07	14.25	169.26	-46.03	5.00E-03	-72.16	-13.67	0.21	6.05
36	-5.77	0.51	-136.84	22.91	13.97	48.13	-47.62	4.16E-03	-147.24	-8.21	0.39	-77.65
37	-10.68	0.29	144.16	24.12	16.07	-78.82	-50.37	3.03E-03	131.49	-7.25	0.43	-146.43
38	-32.53	0.02	70.22	23.59	15.11	148.85	-55.62	1.66E-03	37.70	-10.74	0.29	121.48
39	-16.09	0.16	123.23	23.65	15.23	12.30	-54.20	1.95E-03	-76.46	-15.37	0.17	-4.18
40	-29.19	0.03	44.21	20.79	10.95	-116.29	-43.80	6.46E-03	70.75	-13.01	0.22	-123.56
41	-13.30	0.22	-59.99	21.33	11.66	112.89	-44.57	5.91E-03	-75.57	-8.63	0.37	173.01
42	-11.59	0.26	149.87	20.57	10.68	-35.23	-43.90	6.39E-03	146.83	-6.41	0.48	75.90
43	-12.74	0.23	70.60	14.55	5.34	-173.04	-46.59	4.69E-03	7.19	-10.12	0.31	4.46
44	-10.80	0.29	4.51	12.27	4.10	48.86	-47.60	4.17E-03	-74.19	-15.97	0.16	-73.99
45	-7.28	0.43	-68.05	6.64	2.15	-95.90	-50.63	2.94E-03	175.00	-21.81	0.08	-64.83
46	-5.57	0.53	-149.37	-0.54	0.94	129.12	-45.96	5.04E-03	157.54	-11.06	0.28	-107.83
47	-5.11	0.56	128.69	-7.71	0.41	4.98	-43.66	6.56E-03	42.47	-7.63	0.42	164.84
48	-5.10	0.56	40.23	-14.75	0.18	-116.43	-47.75	4.10E-03	-27.21	-7.78	0.41	65.52
49	-5.16	0.55	-55.86	-21.51	0.08	127.74	-40.36	9.59E-03	-151.21	-7.59	0.42	-65.16
50	-4.69	0.58	-154.92	-33.07	0.02	27.73	-41.94	8.00E-03	170.09	-5.13	0.55	-177.64

Note:

1. Data obtained from 2.4-mm connector based modules, and this data is including connector loss, and board loss. The measurement reference plane is at the RF connectors.

Biasing and Operation

Recommended quiescent DC bias condition for optimum power and linearity performances is $V_{dd}=5$ volts with $V_{gg}(-1V)$ set for $I_{dq}=700$ mA. Minor improvements in performance are possible depending on the application. The drain bias voltage range is 3 to 5V. A single DC gate supply connected to V_{gg} will bias all gain stages. Muting can be accomplished by setting V_{gg} to the pinch-off voltage $V_p(-2V)$.

A typical DC bias configuration is shown in Figure 13. V_{d3} may be biased from either side (Pin 3 or Pin 5). The RF input and output ports are DC decoupled internally. No ground wires are needed since ground connections are made with plated through-holes to the backside of the device.

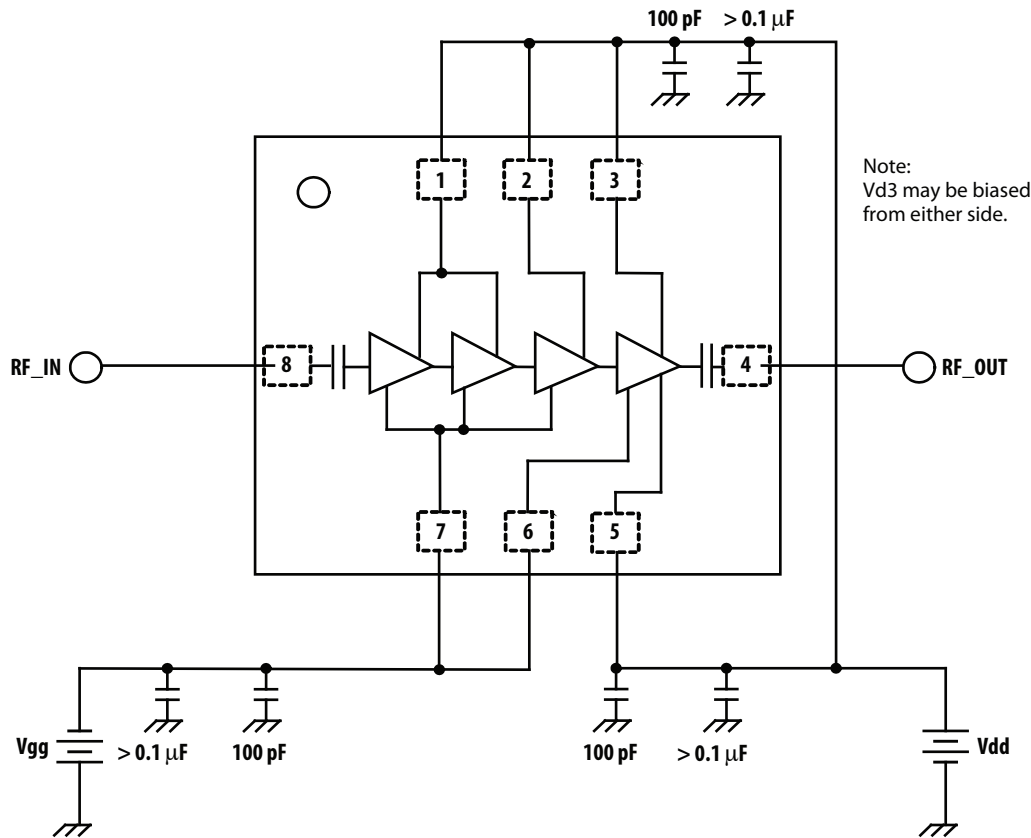

Figure 13. Schematic and recommended assemble example

Note: No RF performance degradation is seen due to ESD up to 250V HBM and 50V MM. The DC characteristics in general show increased leakage at lower ESD discharge voltages. The user is reminded that this device is ESD sensitive and needs to be handled with all necessary ESD protocols.

AMMP-64xx Part Number Ordering Information

Part Number	Devices Per Container	Container
AMMP-6442-BLKG	10	Antistatic bag
AMMP-6442-TR1G	100	7" Reel
AMMP-6442-TR2G	500	7" Reel

Package Dimension, PCB Layout and Tape and Reel information

Please refer to Avago Technologies Application Note 5521, AMxP-xxxx production Assembly Process (Land Pattern B).

For product information and a complete list of distributors, please go to our web site: www.avagotech.com

Avago, Avago Technologies, and the A logo are trademarks of Avago Technologies in the United States and other countries.
Data subject to change. Copyright © 2005-2013 Avago Technologies. All rights reserved.
AV02-2399EN - July 9, 2013

