

FEATURES

- RoHS compliant
- Radial format
- Up to 5.35A I_{DC}
- 4.7μH to 10mH
- Low DC resistance
- Compact size
- MIL-I-23053/5 class III sleeving
- Fully tinned leads
- Supplied in packs of 100
- Custom & axial parts available
- Backward compatible with Sn/Pb soldering systems

DESCRIPTION

The 1800R Series of inductors are particularly suited to use with a wide variety of switching regulators. Offering high current handling with a small footprint, the devices are ideal where space is at a premium.

SELECTION GUIDE

Order Code	Inductance (1kHz, 0.1V _{AC})	DC Current ¹	DC Resistance	Q @ f kHz		SRF
	±10%	Max.	Max.	Nom.		Nom.
	μH	A	mΩ	Q	f	MHz
18R472C	4.7 ²	5.35	9.0	106	1000	35.1
18R682C	6.8	4.15	12.0	73	500	26.3
18R103C	10.0	3.45	15.0	59	500	23.8
18R153C	15.0	3.00	18.0	55	500	17.0
18R223C	22.0	2.42	25.0	51	500	14.1
18R333C	33.0	2.00	40.0	48	500	11.5
18R473C	47.0	1.65	55.0	46	500	9.85
18R683C	68.0	1.35	70.0	27	100	8.29
18R104C	100.0	1.20	100.0	40	100	7.40
18R154C	150.0	1.10	165.0	40	100	5.58
18R224C	220.0	0.90	230.0	39	100	4.00
18R254C	250.0	0.80	255.0	40	100	3.85
18R334C	330.0	0.73	335.0	49	100	3.57
18R474C	470.0	0.60	465.0	50	100	2.81
18R684C	680.0	0.53	630.0	48	100	2.43
18R105C	1.0mH	0.44	1.0Ω	92	50	1.82
18R155C	1.5mH	0.33	1.5Ω	106	50	1.60
18R225C	2.2mH	0.30	2.2Ω	106	50	1.41
18R335C	3.3mH	0.22	3.5Ω	139	50	1.04
18R475C	4.7mH	0.20	4.6Ω	126	40	0.87
18R685C	6.8mH	0.15	7.0Ω	143	40	0.71
18R106C	10.0mH	0.13	12.0Ω	142	40	0.58

TYPICAL CORE/WIRE CHARACTERISTICS

Inductance Temperature Coefficient	Resistance Temperature Coefficient	Curie Temperature (T _c)	Saturation Flux (B _{SAT})
430ppm	4000ppm	190°C	325mT

ABSOLUTE MAXIMUM RATINGS

Operating free air temperature range	0°C to 70°C
Storage temperature range	-55°C to 125°C

SOLDERING INFORMATION³

Peak wave solder temperature	300°C for 10 seconds
Pin finish	Bright tin

All specifications typical at T_a=25°C

- 1 Maximum DC current occurs when either the inductance falls to 90% of its nominal value or when its temperature rise reaches 30°C, whichever is sooner.
- 2 Tolerance ±15%.
- 3 For further information, please visit www.murata-ps.com/rohs



For full details go to
www.murata-ps.com/rohs

PACKAGE SPECIFICATIONS

MECHANICAL DIMENSIONS

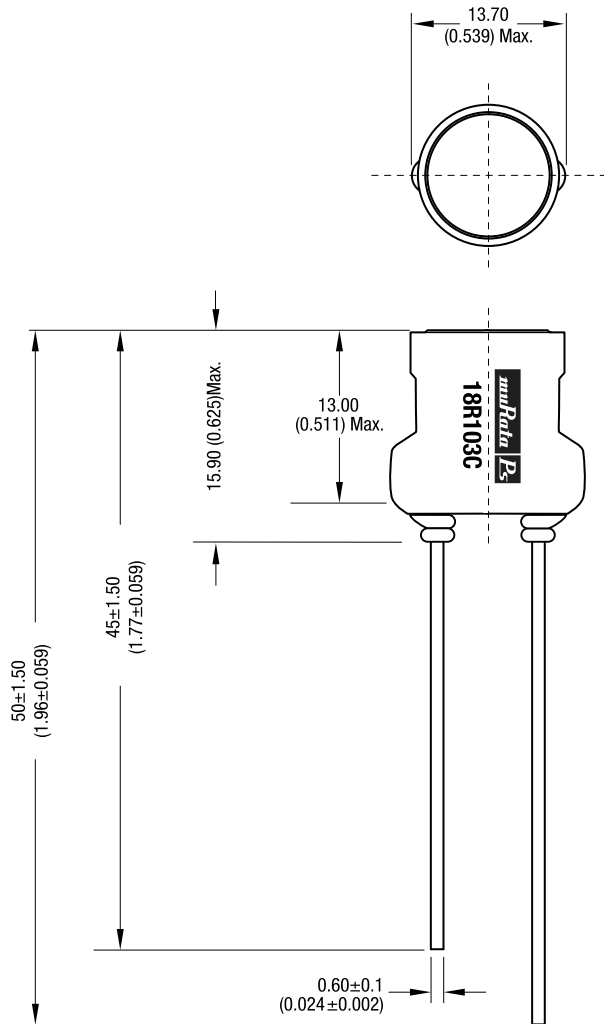

All dimensions in mm (inches). Package weight 4.6g Typ.

RECOMMENDED FOOTPRINT DETAILS

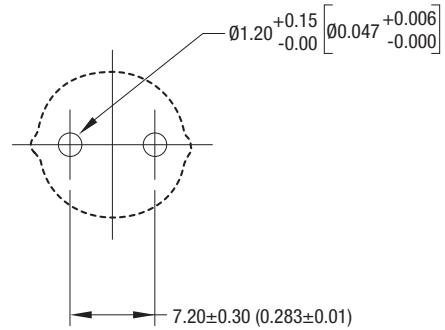

All dimensions in mm (inches)

Murata Power Solutions, Inc.
 11 Cabot Boulevard, Mansfield, MA 02048-1151 U.S.A.
 ISO 9001 and 14001 REGISTERED

Murata Power Solutions, Inc. makes no representation that the use of its products in the circuits described herein, or the use of other technical information contained herein, will not infringe upon existing or future patent rights. The descriptions contained herein do not imply the granting of licenses to make, use, or sell equipment constructed in accordance therewith. Specifications are subject to change without notice.
 © 2012 Murata Power Solutions, Inc.