

# Switching Power Supply Type SPD 100W Bi-Phase DIN rail mounting



- Installation on DIN Rail 7.5 or 15mm
- Short circuit protection
- Input single phase 340 to 575VAC
- Passive PFC
- Power ready output on 24VDC
- LED indicator for DC power ON
- LED indicator for DC low
- Standard parallel function
- Very compact dimensions
- UL, cUL listed and TUV/CE approved
- Class I Div 2 Groups A, B, C, D approved

## Product Description

This particular SPD is the most compact 100W power supply on the market. Relay output for “power ready” parallel function and PFC are included. Performances are unique with high efficiencies

and the possibility of being used up to 70°C with a little derating. Furthermore it can be powered with 2 phases of a 3 phase grid system due to its high voltage input.

## Ordering Key

**SP D 24 100 2**

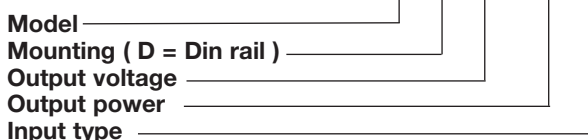

Input type: 2= single phase high voltage (bi-phase)

## Approvals



## Output Performances

Model	Rated output Voltage (VDC)	Output Power (W)	Output Current (A)	Voltage Trim Range 0.8 I <sub>o nom</sub>		DC ON LED (VDC) Threshold at startup		DC LO LED (VDC) Threshold after startup		Typical Efficiency
				Min. VDC	Max. VDC	Min.	Max.	Min.	Max.	
SPD12100	12	100.8	8.4	11.4	14.5	10	11.2	10	11.2	86%
SPD24100	24	100.8	4.2	22.5	28.5	17.6	19.4	17.6	19.4	87%
SPD48100	48	100.8	2.1	47.0	56.0	37.0	43.0	37.0	43.0	89%

## Output Data

Output voltage accuracy	-0 +1% max (factory adjusted)
Line regulation	± 1%
Load regulation	± 1%
Non parallel model	± 1%
Parallel model	± 5%
Temp. coefficient	± 0.03% / °C
Ripple and noise	50mV
V <sub>i nom</sub> , I <sub>o nom</sub> , BW=20MHz	
Rated continuous Loading	8.4A @ 12VDC / 6.9A @ 14.5VDC 4.2A @ 24VDC / 3.5A @ 28.5VDC 2.1A @ 48VDC / 1.8A @ 56VDC
Fall Time	150ms
Transient recovery time	2ms
V <sub>i nom</sub> , I <sub>o</sub> = 0.5 x I <sub>o nom</sub>	
Turn On Time	1.0s
V <sub>i nom</sub> , I <sub>o nom</sub>	
V <sub>i nom</sub> , I <sub>o nom</sub> with Capacitor load	1.5s

Rise Time	
V <sub>i nom</sub> , I <sub>o nom</sub>	150ms
V <sub>i nom</sub> , I <sub>o nom</sub> with Capacitor load	500ms
Capacitor Load	
12V, 24V versions	7000µF
48V version	3500µF
Reverse Voltage Immunity	
12V	18V
24V	35V
48V	63V
Hold up Time V <sub>i nom</sub> I <sub>o max</sub>	20ms
Minimum load V <sub>i nom</sub>	0%
Parallel Operation	2 units max.
0.1 I <sub>o min</sub> ~ 0.9 I <sub>o max</sub>	



## Input Data

<b>Rated input voltage</b>	400/500VAC	<b>Frequency range</b>	47 - 63Hz
<b>Voltage range</b> AC in DC in	340 - 575VAC 480 - 820VDC	<b>Internal Voltage Surge Protection</b> (acc. to IEC61000-4-5)	Varistor
<b>Rated input current</b>	0.48A / 0.75A	<b>Leakage Current</b> Input / Output Input / FG	0.25mA 3.5mA
<b>Power dissipation</b> 12V 24V 48V	15.0W 13.0W 10.5W	<b>Inrush current</b>	10A
		<b>P.F.C.</b>	0.55

## Controls and Protections

<b>Input Fuse</b>	2A/600VAC internal <sup>1)</sup>	<b>Input Voltage Surge Protection</b>	Varistor
<b>Output Short Circuit</b>	current limit	<b>Power ready</b> (only SPD241002) Threshold at start up (contact closed)	Min. 17.6VDC - Max.19.4VDC
<b>Rated Overload Protection</b>	115 - 135%	Contact rating at 60VDC Insulation	0.3A 500VDC
<b>Over voltage protection</b> (auto recovery) 12V model 24V model 48V model	14.5V to 17.4V 30.0V to 33.0V 60.0V to 66.0V		

<sup>1)</sup> Fuse not replaceable by user

## General Data (@ nominal line, full load, 25°C )

<b>Ambient temperature</b>	-25°C to 71°C	<b>MTBF (Bellcore Issue 6@40°C), GB</b> 12V model 24V model 48V model	622.000h 661.000h 672.000h
<b>Derating (&gt;61°C to +71°C)</b>	2.5% / °C	<b>Altitude during operation</b>	3.000m
<b>Ambient humidity</b>	20 to 95%RH	<b>Case material</b>	Plastic
<b>Storage</b>	-25°C to +85°C	<b>Dimensions L x W x D</b>	90 x 54 x 114mm
<b>Pollution degree</b>	2	<b>Weight</b>	500g
<b>Protection degree</b>	IP20		
<b>Cooling</b>	Free air convection		
<b>Switching frequency</b>	45kHz		

## Approvals and EMC

<b>Insulation voltage</b> Input / Output Input / FG	3.000VAC / 4242VDC 1500VAC / 2121VDC	<b>CE</b>	EN 61000-6-3, EN 55022 Class B, EN 61000-3-2, EN 61000-3-3 EN 61000-6-2, EN 55024, EN 61000-4-2 Level 4, EN 61000-4-3 Level 3 EN 61000-4-4 Level 4, EN 61000-4-5 L-N Level 3, L / N-FG Level 4 EN 61000-4-6 Level 3, EN 61000-4-8 Level 4, EN 61000-4-11 ENV 50204 Level 2, EN 61204-3
<b>Insulation resistance</b>	100MΩ min		
<b>Shock resistance</b>	acc. to IEC 60068-2-27 (15G, 11ms, 3 Axis, 6 Faces, 3 times for each Face)		
<b>Vibration resistance</b>	acc. to IEC 60068-2-6 (Mounting by rail: 10-500 Hz, 2G, along X, Y, Z each Axis, 60 min for each Axis)		
<b>UL / cUL</b>	UL 508 Listed UL 60950-1		
<b>TUV</b>	EN 60950-1, CB scheme EN 61558-1, EN 61558-2-17 (acc.to EN 60204)		
<b>ISA</b>	12.12.01 Class I Div 2 Groups A, B, C, D		



## Block Diagrams

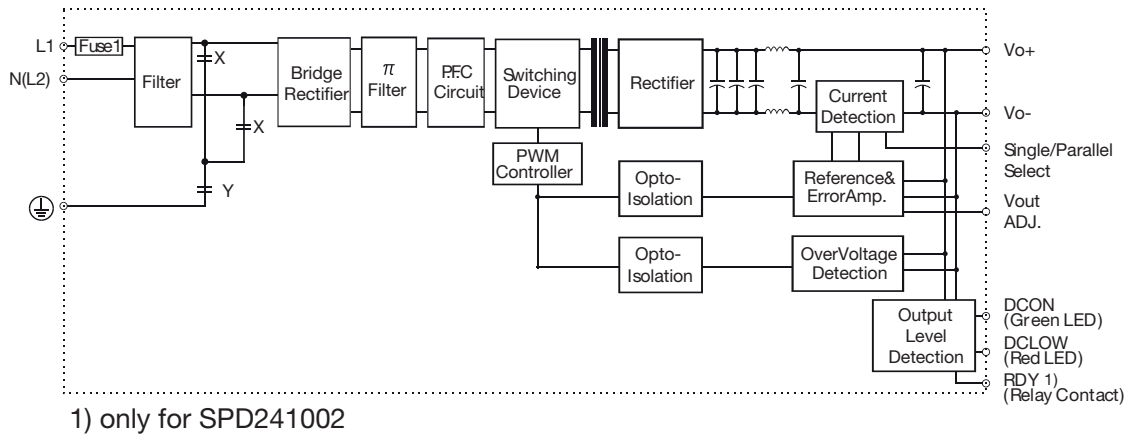

## Pin Assignment and Front Controls

Pin No.	Designation	Description
1	RDY	NO relay contact for DC OK (only SPD241002)
2	RDY	NO relay contact for DC OK (only SPD241002)
3	V+	Positive output terminal
4	V+	Positive output terminal
5	V-	Negative output terminal
6	V-	Negative output terminal
7	GND	Ground terminal to minimise High frequency emissions
8	N or L2	Neutral or phase 2 (no polarity with DC input)
9	L1	Phase 1 (no polarity with DC input)
L1	DC ON	DC output ready LED
L2	DC LO	DC low indicator LED
POT1	Vout ADJ.	Trimmer for fine output voltage adjustment
SW1	S/P	Single / Parallel select switch

## Typ. Current Limited Curve

SPD241002 / 400VAC

SPD241002 / 500VAC

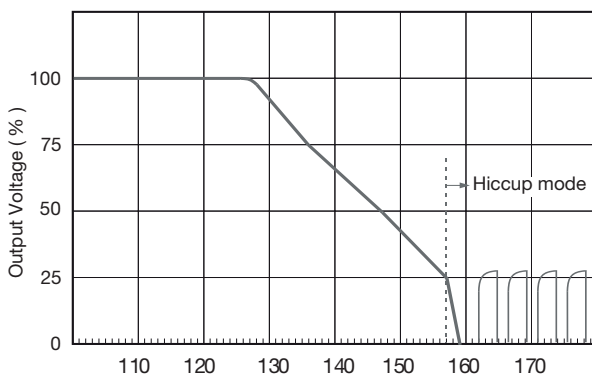

Power Out (%)

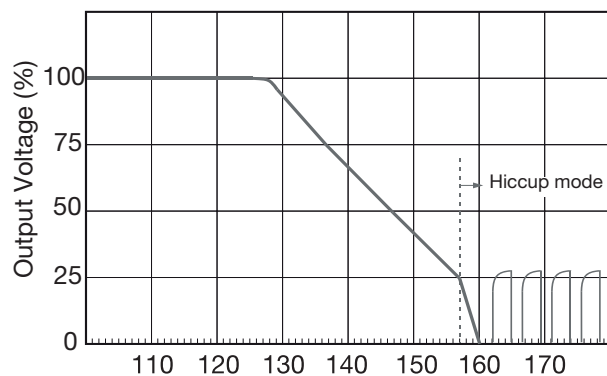

Power Out (%)

## Typ. Efficiency Curve

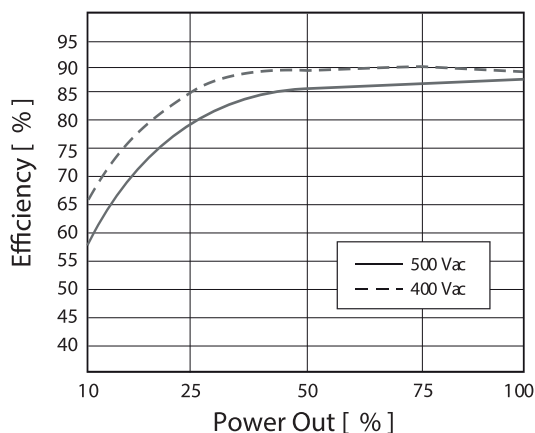

## Derating Diagram

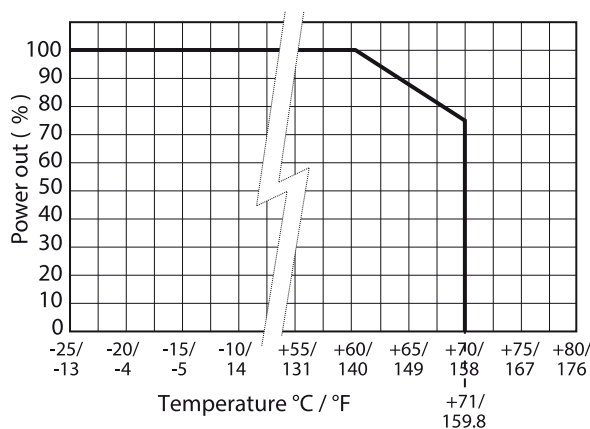

## Mechanical Drawings mm (inches)

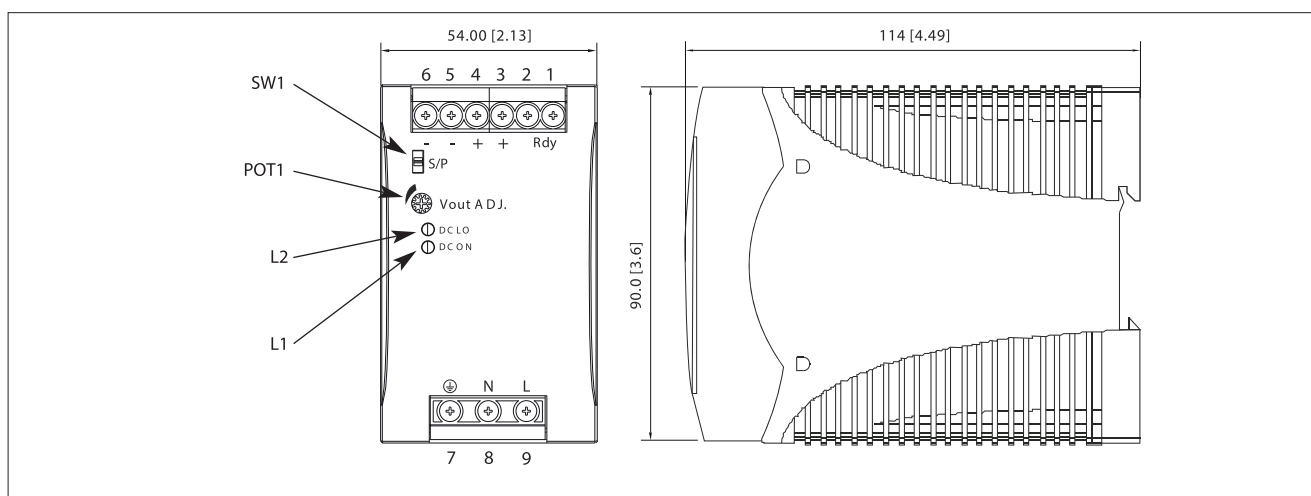

## Installation

<b>Ventilation and cooling</b>	Normal convection All sides 25mm free space for cooling is recommended
<b>Screw terminals</b> 8mm stripping recommend	10-24AWG flexible or solid cable
<b>Max. torque for screws terminals</b> Input terminals Output terminals	1.008Nm (9.0lb-in) 0.616Nm (5.5lb-in)
<b>Plug-in connectors</b> 7mm stripping recommend	10-24AWG flexible or solid cable
<b>Max. torque for plug-in terminals</b> Input terminals Output terminals	0.784Nm (7.0lb-in) 0.784Nm (7.0lb-in)
<b>Recommended circuit breaker</b>	3A / 5A / 6A B, D characteristics