

# NHD-4.3CTP-SHIELD-L

## Color TFT Liquid Crystal Display Module + Arduino Shield

NHD-	Newhaven Display
4.3-	4.3" Diagonal
CTP-	Capacitive Touch Panel with Controller
SHIELD-	Arduino Shield
L-	Display: NHD-4.3-480272EF-ATXL#-CTP, 6:00 Optimal View, Wide Temperature

**Newhaven Display International, Inc.**

2661 Galvin Ct.

Elgin IL, 60124

Ph: 847-844-8795

Fax: 847-844-8796

[www.newhavendisplay.com](http://www.newhavendisplay.com)

[nhtech@newhavendisplay.com](mailto:nhtech@newhavendisplay.com)

[nhsales@newhavendisplay.com](mailto:nhsales@newhavendisplay.com)

## Document Revision History

Revision	Date	Description	Changed by
0	08/17/16	Initial Release	PB

## Functions and Features

- 480xRGBx272 resolution, up to 262K colors
- Utilizes the FTDI FT801 Embedded Video Engine
- PWM backlight control
- Onboard audio power amplifier
- microSD card reader (microSD card not included)
- Built-in logic level shifting
- Assembled with NHD-4.3-480272EF-ATXL#-CTP
- Capacitive touch panel with controller
  - 5 point multi-touch input
  - Gesture input
    - Zoom In/Out
    - Swipe Up/Down/Left/Right

## User Guide:

Please download User Guide at [http://www.newhavendisplay.com/userguides/NHD-4.3CTP-SHIELD\\_User\\_Guide.pdf](http://www.newhavendisplay.com/userguides/NHD-4.3CTP-SHIELD_User_Guide.pdf)

# Mechanical Drawing

Rev	Description	Date
1.0	Initial Release	08/17/16

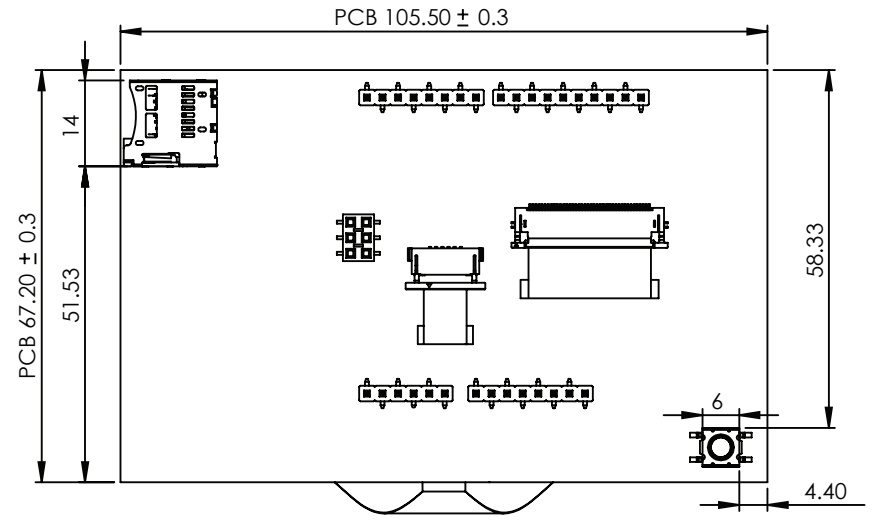
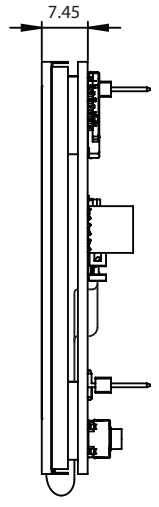
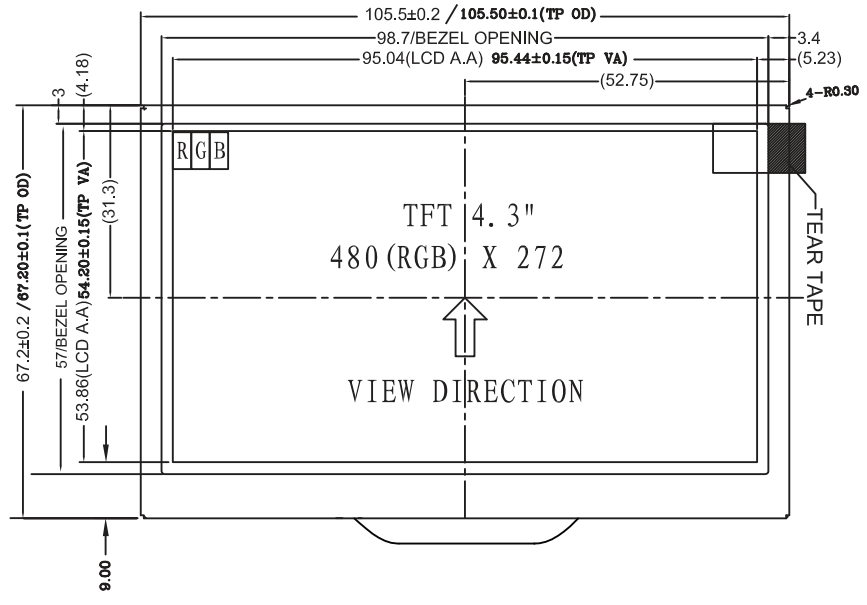

- NOTES:
1. Display Size: 4.3" TFT
  2. Optimal Viewing Direction: 6:00
  3. Display Mode: Transmissive / Normally White / Anti-Glare
  4. Luminance: 350 cd/m<sup>2</sup>
  5. Touch Panel: PCAP

Unit mm		
Gen. Tol. ±0.3	Date 08/17/16	Model: NHD-4.3CTP-SHIELD-L



# Schematic

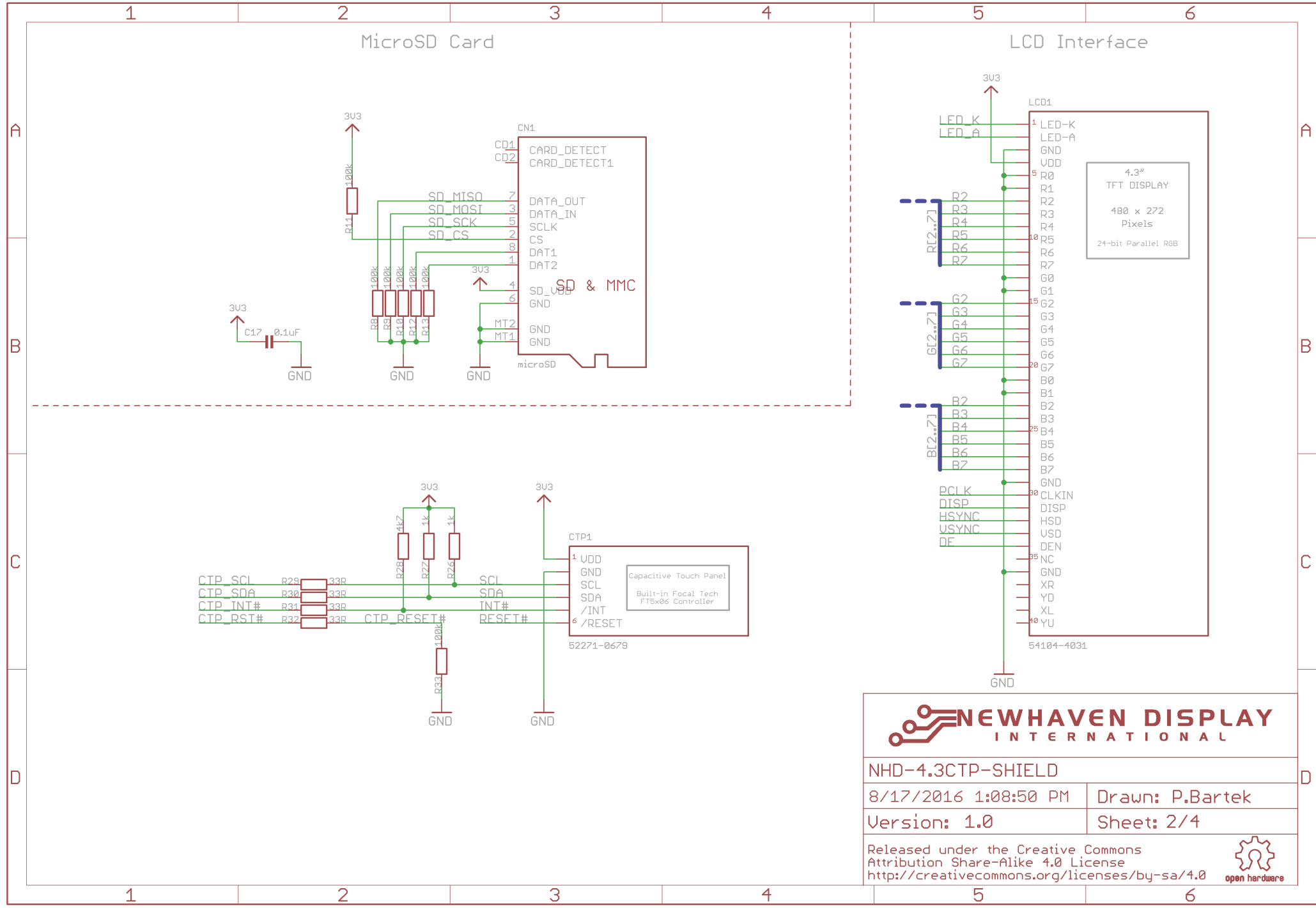

**NEWHAVEN DISPLAY**  
INTERNATIONAL

NHD-4.3CTP-SHIELD

8/17/2016 1:08:50 PM	Drawn: P.Bartek
Version: 1.0	Sheet: 2/4

Released under the Creative Commons Attribution Share-Alike 4.0 License  
<http://creativecommons.org/licenses/by-sa/4.0>

open hardware

# Schematic

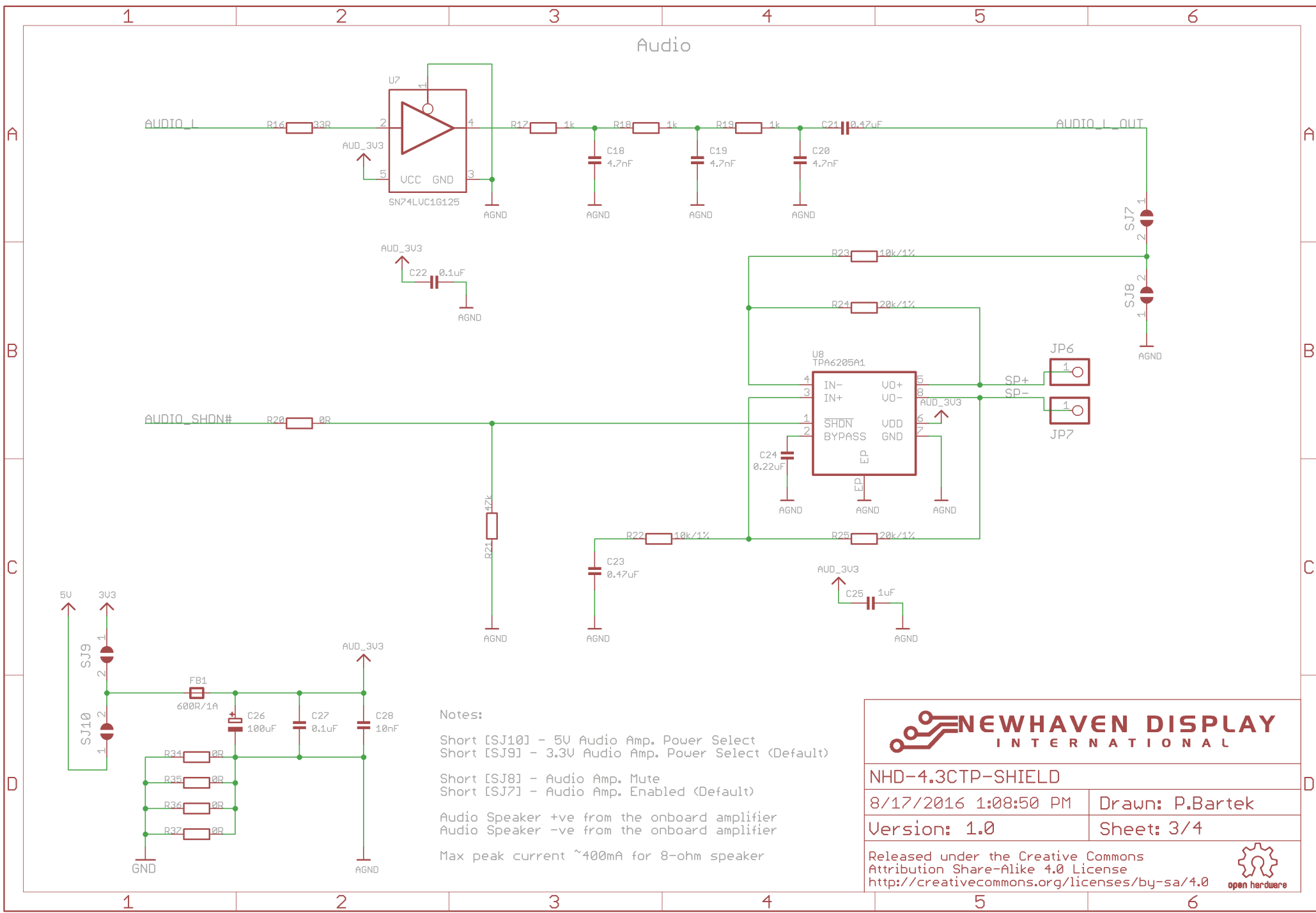



**NEWHAVEN DISPLAY**  
INTERNATIONAL

<b>NHD-4.3CTP-SHIELD</b>	
8/17/2016 1:08:50 PM	Drawn: P.Bartek
Version: 1.0	Sheet: 3/4
Released under the Creative Commons Attribution Share-Alike 4.0 License <a href="http://creativecommons.org/licenses/by-sa/4.0">http://creativecommons.org/licenses/by-sa/4.0</a>	



open hardware

# Schematic

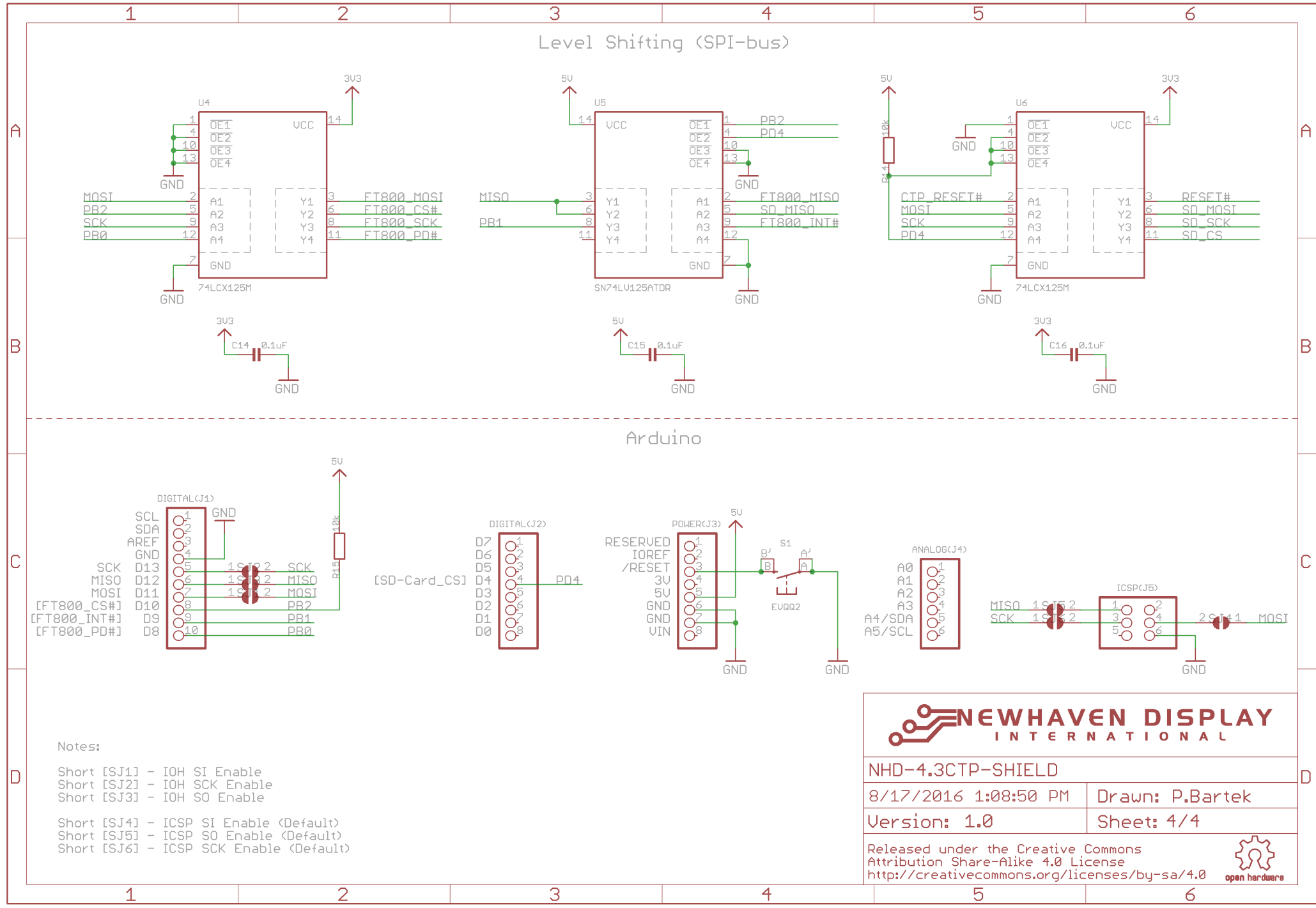

**Notes:**

- Short [SJ1] - IOH SI Enable
- Short [SJ2] - IOH SCK Enable
- Short [SJ3] - IOH SO Enable
- Short [SJ4] - ICSP SI Enable (Default)
- Short [SJ5] - ICSP SO Enable (Default)
- Short [SJ6] - ICSP SCK Enable (Default)

  
**NEWHAVEN DISPLAY**  
 INTERNATIONAL

---

**NHD-4.3CTP-SHIELD**

---

8/17/2016 1:08:50 PM	Drawn: P.Bartek
Version: 1.0	Sheet: 4/4

---

Released under the Creative Commons Attribution Share-Alike 4.0 License  
<http://creativecommons.org/licenses/by-sa/4.0>

## Pin Description

Arduino UNO Pin Symbol	Function Description
<b>J1 Interface</b>	
SCL	No Connect
SDA	No Connect
AREF	No Connect
GND	Ground
13	No Connect (Short SJ2 for SPI SCK signal)
12	No Connect (Short SJ3 for SPI MISO signal)
11	No Connect (Short SJ1 for SPI MOSI signal)
10	FT801 Active LOW Chip Select signal
9	FT801 Active LOW Host Interrupt signal
8	FT801 Active LOW Power Down signal
<b>J2 Interface</b>	
7	No Connect
6	No Connect
5	No Connect
4	microSD Active LOW Chip Select signal
3	No Connect
2	No Connect
1	No Connect
0	No Connect
<b>J3 Interface</b>	
RESERVED	No Connect
IOREF	No Connect
RESET	No Connect
3.3V	No Connect
5V	Supply Voltage for Module (+5V)
GND	Ground
GND	Ground
Vin	No Connect
<b>J4 Interface</b>	
A0	No Connect
A1	No Connect
A2	No Connect
A3	No Connect
A4	No Connect
A5	No Connect
<b>J5 Interface</b>	
MISO	SPI MISO signal (Default)
5V	No Connect
SCK	SPI SCK signal (Default)
MOSI	SPI MOSI signal (Default)
RESET	No Connect
GND	Ground



## Electrical Characteristics

Item	Symbol	Condition	Min.	Typ.	Max.	Unit
Operating Temperature Range	T <sub>OP</sub>	Absolute Max	-20	-	+70	°C
Storage Temperature Range	T <sub>ST</sub>	Absolute Max	-30	-	+80	°C
Supply Voltage	V <sub>DD</sub>	-	4.8	5.0	5.5	V
Supply Current	I <sub>DD</sub>	V <sub>DD</sub> = 5V	-	250	340	mA
"H" level input	V <sub>IH</sub>	-	2.2	-	V <sub>DD</sub>	V
"L" level input	V <sub>IL</sub>	-	GND	-	0.8	V

## Optical Characteristics

Item	Symbol	Condition	Min.	Typ.	Max.	Unit
Optimal Viewing Angles	Top	Cr ≥ 10	-	50	-	°
	Bottom		-	70	-	°
	Left		-	70	-	°
	Right		-	70	-	°
Contrast Ratio	Cr	-	400	500	-	-
Luminance	Lv	I <sub>LED</sub> = 40 mA	-	350	-	cd/m <sup>2</sup>
Response Time	Rise	T <sub>OP</sub> = 25°C	-	25	30	ms
	Fall	-	-	25	30	ms

## Capacitive Touch Panel Material Characteristics

Property	Requirement	Unit
IC	FT5306DE4	-
ITO Glass Thickness	0.55	mm
Surface Hardness	≥6	H
Transparency	83% ± 5%	-
Operating Humidity	20~90	RH
Storage Humidity	20~90	RH

## Controller Information

### TFT Controller:

Built-in FTDI FT801 Embedded Video Engine.

Please download specification at [http://www.ftdichip.com/Support/Documents/DataSheets/ICs/DS\\_FT801.pdf](http://www.ftdichip.com/Support/Documents/DataSheets/ICs/DS_FT801.pdf)

## Display Information

### TFT:

NHD-4.3-480272EF-ATXL#-CTP - Standard 4.3" TFT, 480x272 Pixels, 24-bit Parallel RGB Interface, w/ Projected Capacitive Touch Panel.

Please download specification at <http://www.newhavendisplay.com/specs/NHD-4.3-480272EF-ATXL-CTP.pdf>

## Block Diagram

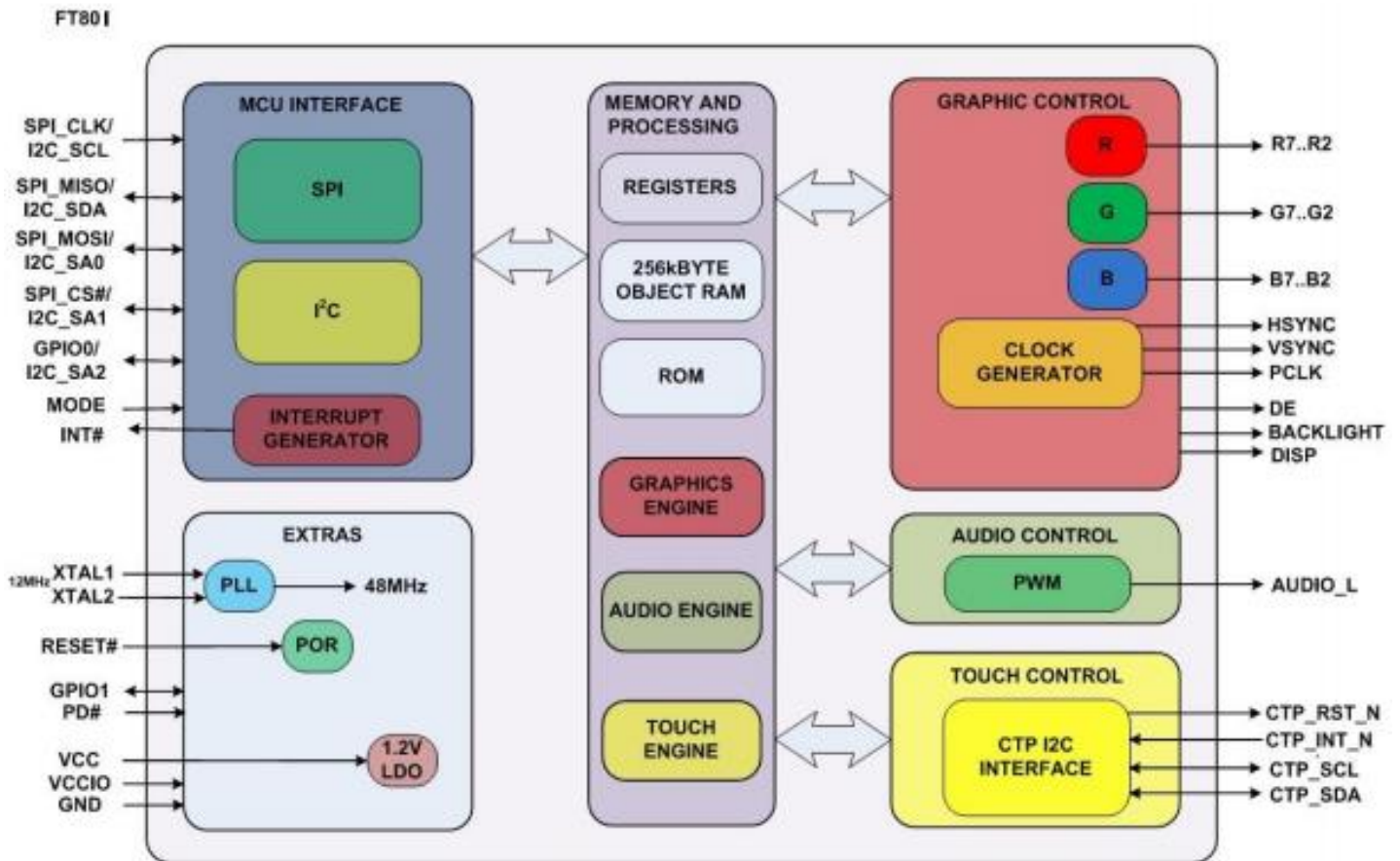

## Host Interface

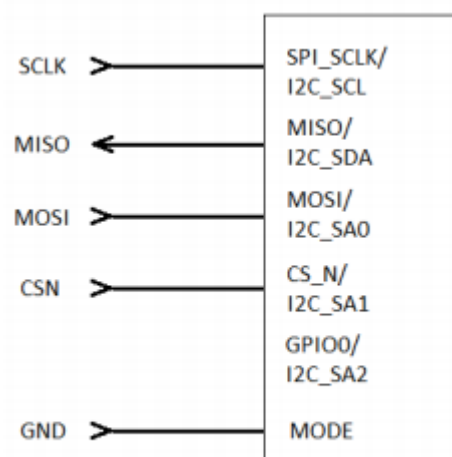

SPI Interface Connection

**SPI Interface** – The SPI slave interface operates up to 30MHz. Only SPI mode 0 is supported. The SPI interface is selected by default (MODE pin is internally pulled low by a 100k resistor).

## Timing Characteristics

### SPI Interface:

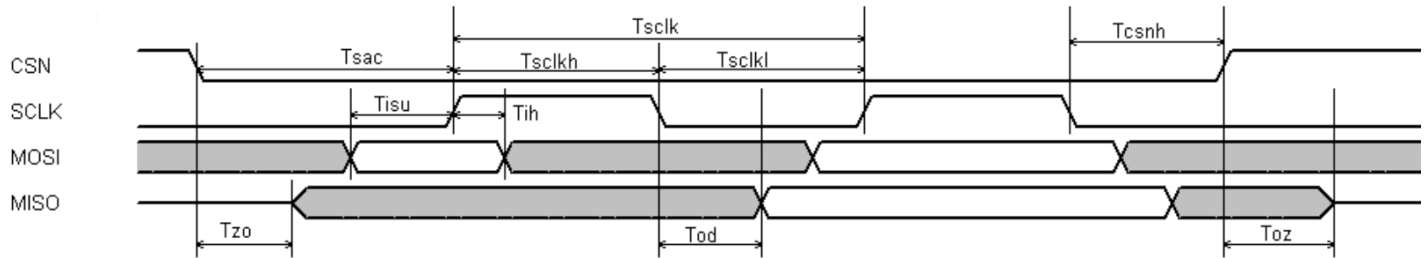

Parameter	Description	VCC(I/O)=1.8V		VCC(I/O)=2.5V		VCC(I/O)=3.3V		Units
		Min	Max	Min	Max	Min	Max	
Tsclk	SPI clock period	60	-	40	-	33	-	ns
Tsckl	SPI clock low duration	25	-	16	-	13	-	ns
Tsckh	SPI clock high duration	25	-	16	-	13	-	ns
Tsac	SPI access time	16	-	16	-	16	-	ns
Tisu	Input Setup	12	-	11	-	11	-	ns
Tih	Input Hold	3	-	3	-	3	-	ns
Tzo	Output enable delay	0	30	0	20	0	16	ns
Toz	Output disable delay	0	30	0	20	0	16	ns
Tod	Output data delay	0	24	0	15	0	12	ns
Tcsnh	CSN hold time	0	-	0	-	0	-	ns

For more information about FT801 controller please go to official FT801 Datasheet.

[http://www.ftdichip.com/Support/Documents/DataSheets/ICs/DS\\_FT801.pdf](http://www.ftdichip.com/Support/Documents/DataSheets/ICs/DS_FT801.pdf)

## Quality Information

Test Item	Content of Test	Test Condition	Note
High Temperature storage	Endurance test applying the high storage temperature for a long time.	+80°C , 96hrs	2
Low Temperature storage	Endurance test applying the low storage temperature for a long time.	-30°C , 96hrs	1,2
High Temperature Operation	Endurance test applying the electric stress (voltage & current) and the high thermal stress for a long time.	+70°C , 96hrs	2
Low Temperature Operation	Endurance test applying the electric stress (voltage & current) and the low thermal stress for a long time.	-20°C , 96hrs	1,2
High Temperature / Humidity Operation	Endurance test applying the electric stress (voltage & current) and the high thermal with high humidity stress for a long time.	+60°C , 90% RH , 96hrs	1,2
Thermal Shock resistance	Endurance test applying the electric stress (voltage & current) during a cycle of low and high thermal stress.	-20°C,30min -> 25°C,5min ->70°C,30min = 1 cycle 10 cycles	
Vibration test	Endurance test applying vibration to simulate transportation and use.	10-55Hz , 15mm amplitude. 60 sec in each of 3 directions X,Y,Z For 15 minutes	3
Static electricity test	Endurance test applying electric static discharge.	VS=800V, RS=1.5kΩ, CS=100pF One time	

**Note 1:** No condensation to be observed.

**Note 2:** Conducted after 4 hours of storage at 25°C, 0%RH.

**Note 3:** Test performed on product itself, not inside a container.

## Precautions for using LCDs/LCMs

See Precautions at [www.newhavendisplay.com/specs/precautions.pdf](http://www.newhavendisplay.com/specs/precautions.pdf)

## Warranty Information

See Terms & Conditions at [http://www.newhavendisplay.com/index.php?main\\_page=terms](http://www.newhavendisplay.com/index.php?main_page=terms)