



Technical Data Sheet

High Power Infrared LED

HIR5393C/L223

Features

- Popular 10mm package.
- High radiant intensity
- Peak wavelength $\lambda_p=850\text{nm}$
- Low forward voltage
- Pb free
- The product itself will remain within RoHS compliant version.
- Soldering methods: Dip soldering.



Descriptions

- EVERLIGHT'S Infrared Emitting Diode(HIR5393C/L223) is a high intensity diode , molded in a water clear plastic package.
- The device is spectrally matched with phototransistor , photodiode and infrared receiver module.

Applications

- CCD Camera
- Infrared applied system

Device Selection Guide

LED Part No.	Chip	Lens Color
	Material	
HIR5393C/L223	GaAlAs	Water Clear

Package Dimensions

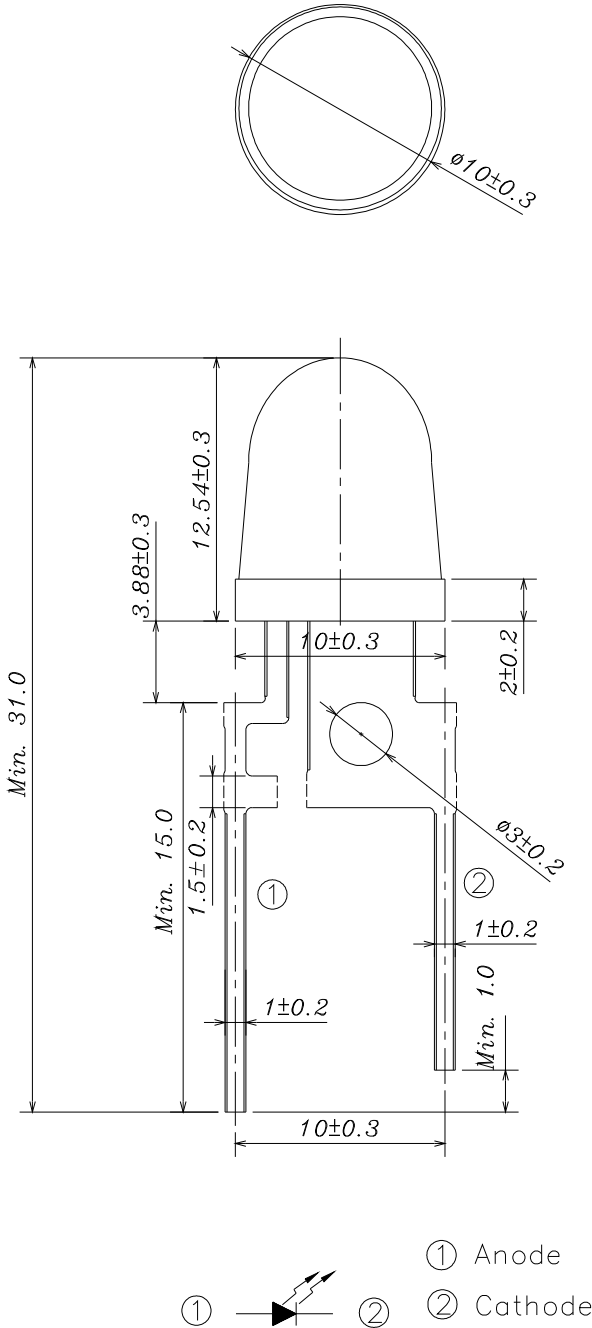

- Other dimensions are in millimeters, tolerance is 0.25mm except being specified.
- Protruded resin under flange is 1.5mm Max LED.
- Bare copper alloy is exposed at tie-bar portion after cutting.

Absolute Maximum Ratings (Ta=25°C)

Parameter	Symbol	Rating	Units
Continuous Forward Current	I_F	350	mA
Reverse Voltage	V_R	5	V
Operating Temperature	T_{opr}	-40 ~ +100	°C
Storage Temperature	T_{stg}	-40 ~ +100	°C
Thermal resistance (junction to leadframe)	$R_{th(j-L)}$	20	K/W
Soldering Temperature* 1	T_{sol}	260 ±5	°C
Power Dissipation at(or below) 25°C Free Air Temperature	P_d	0.5	W

Notes: *1:Soldering time ≤ 5 seconds.

Electro-Optical Characteristics (Ta=25°C)

Parameter	Symbol	Condition	Min.	Typ.	Max.	Units
Radiant Intensity	I_e	$I_F=150mA$	150	200	326	mW/sr
		$I_F=350mA$	--	470	--	
Peak Wavelength	λ_p	$I_F=20mA$	--	850	--	nm
Spectral Bandwidth	$\Delta \lambda$	$I_F=20mA$	--	50	--	nm
Forward Voltage	V_F	$I_F=150mA$	--	1.5	2.1	V
		$I_F=350mA$	--	1.7	2.4	
Reverse Current	I_R	$V_R=5V$	--	--	10	μA
View Angle	$2\theta_{1/2}$	$I_F=20mA$	--	25	--	deg
Rise Time	T_r	$I_F=20mA$	--	11	--	ns
Fall Time	T_f	$I_F=20mA$	--	7	--	ns

Rank

Condition : $I_F=150mA$

Unit : mW/sr

Bin Number	A	B	C	D
Min	150	175	200	225
Max	218	254	290	326

Note. 1. Radiant Intensity measurement tolerance : ±10%

2. $2\theta_{1/2}$ is the off axis angle from lamp centerline where the radiant intensity is 1/2 of the peak value.

3. Forward Voltage measurement tolerance : ±0.1V

Typical Electro-Optical Characteristics Curves

Fig.1 Forward Current vs. Ambient Temperature

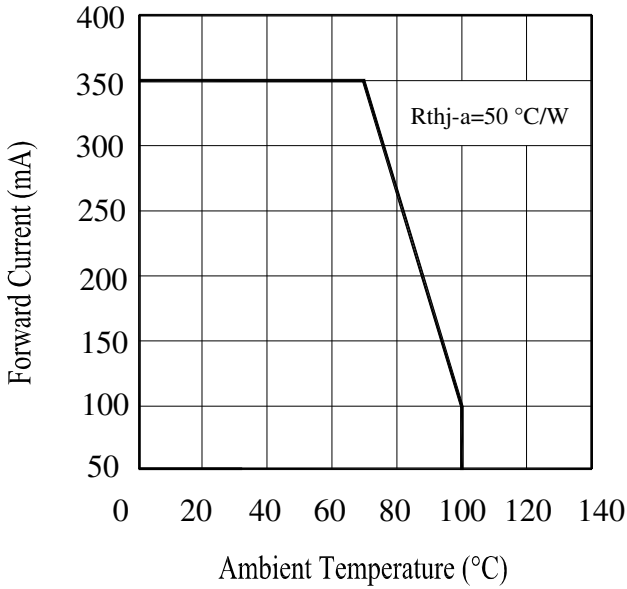

Fig.2 Spectral Distribution

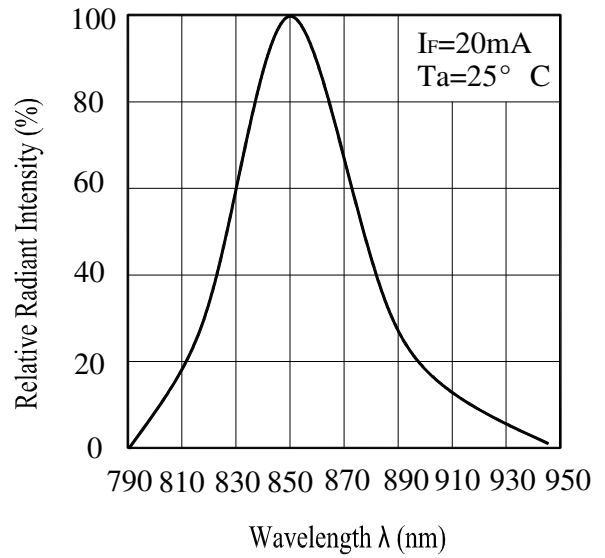

Fig.3 Peak Emission Wavelength vs. Ambient Temperature

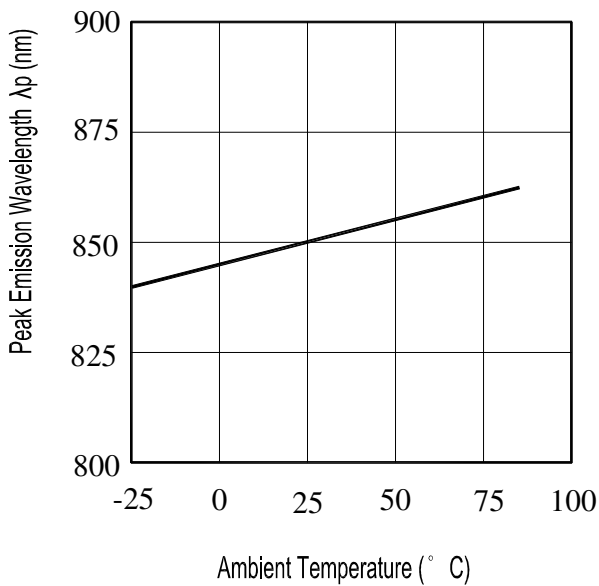
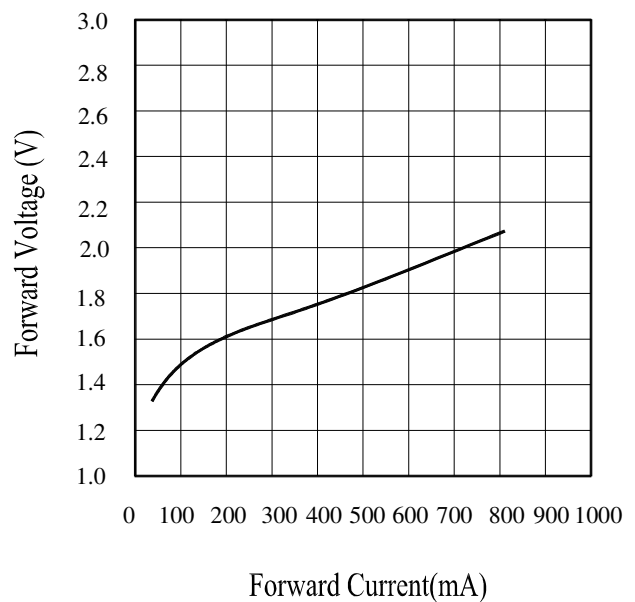

Fig.4 Forward Current vs. Forward Voltage



Typical Electro-Optical Characteristics Curves

Fig.5 Relative Intensity vs.
Forward Current

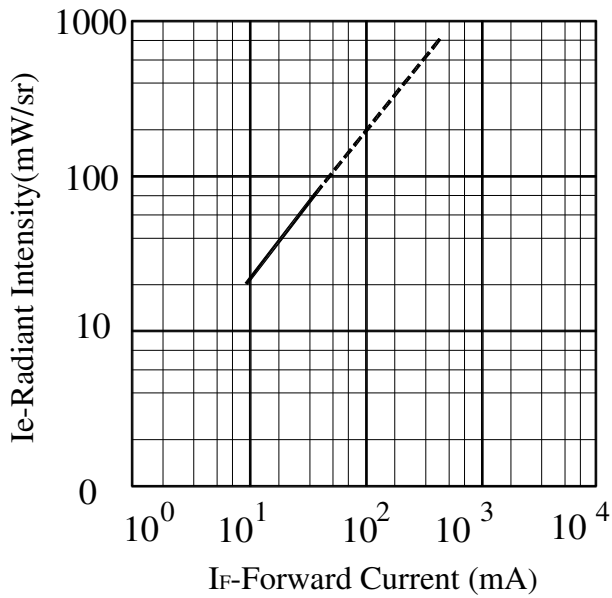
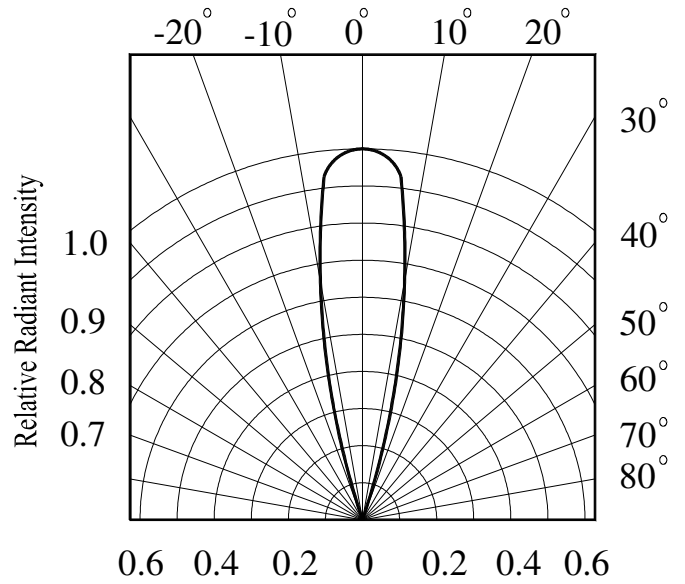

Fig.6 Relative Radiant Intensity vs.
Angular Displacement



Reliability Test Item And Condition

The reliability of products shall be satisfied with items listed below.

Confidence level : 90%

LTPD : 10%

NO.	Item	Test Conditions	Test Hours/ Cycles	Sample Sizes	Failure Judgement Criteria	Ac/Re
1	Solder Heat	TEMP. : 260°C±5°C	10secs	22pcs	$I_R \geq U \times 2$ $I_e \leq L \times 0.8$ $V_F \geq U \times 1.2$ U : Upper Specification Limit L : Lower Specification Limit	0/1
2	Temperature Cycle	H : +100°C 15mins \updownarrow 5mins L : -40°C 15mins	300Cycles	22pcs		0/1
3	Thermal Shock	H : +100°C 5mins \updownarrow 10secs L : -10°C 5mins	300Cycles	22pcs		0/1
4	High Temperature Storage	TEMP. : +100°C	1000hrs	22pcs		0/1
5	Low Temperature Storage	TEMP. : -40°C	1000hrs	22pcs		0/1
6	DC Operating Life	$I_F=350mA$	1000hrs	22pcs		0/1
7	High Temperature/ High Humidity	85°C / 85% R.H	1000hrs	22pcs		0/1

Packing Quantity Specification

1.200PCS/1Bag , 3Bags/1Box

2.10Boxes/1Carton

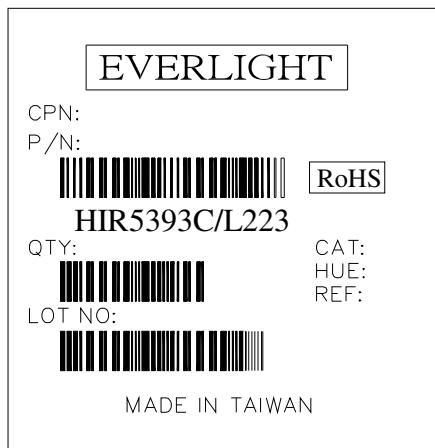
Label Form Specification (For box)

CPN: Customer's Production Numb

P/N : Production Number

QTY: Packing Quantity

CAT: Ranks

HUE: Peak Wavelength

REF: Reference

LOT No: Lot Number

MADE IN TAIWAN: Production Place

Notes

1. Above specification may be changed without notice. EVERLIGHT will reserve authority on material change for above specification.
2. When using this product, please observe the absolute maximum ratings and the instructions for using outlined in these specification sheets. EVERLIGHT assumes no responsibility for any damage resulting from use of the product which does not comply with the absolute maximum ratings and the instructions included in these specification sheets.
3. These specification sheets include materials protected under copyright of EVERLIGHT corporation. Please don't reproduce or cause anyone to reproduce them without EVERLIGHT's consent.
4. If the emitter is operated, consider using metal heat sink with the lowest possible thermal resistance. For the thermal performance using a flat heat sink, allow an exposed surface area of about 25mm² at least.

5. Soldering Condition

Careful attention should be paid during soldering. When soldering, leave more than 3mm from solder joint to case, and soldering beyond the base of the tie bar is recommended.

Avoiding applying any stress to the lead frame while the LEDs are at high temperature particularly when soldering.

Recommended soldering conditions:

Hand Soldering		DIP Soldering	
Temp. at tip of iron	400°C Max. (30W Max.)	Preheat temp.	100°C Max. (60 sec Max.)
Soldering time	3 sec Max.	Bath temp.	265 Max.
Distance	3mm Min.(From solder joint to case)	Bath time.	5 sec Max.
		Distance	3mm Min.

EVERLIGHT ELECTRONICS CO., LTD.
Office: No 25, Lane 76, Sec 3, Chung Yang Rd,
Tucheng, Taipei 236, Taiwan, R.O.C

Tel: 886-2-2267-2000, 2267-9936
Fax: 886-2267-6244, 2267-6189, 2267-6306
<http://www.everlight.com>