

Bridgelux® SMD 5050 5W 36V

Product Data Sheet DS64

Introduction

SMD 5050

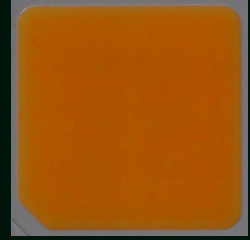

The Bridgelux SMD 5050 high power LED is hot-color targeted which ensures that the LEDs fall within their specified color bin at the typical application conditions of 85°C. With its broad lumen coverage and wide range of CCT options, the SMD 5050 provides unparalleled design-in flexibility for indoor and outdoor lighting applications. The SMD 5050 is ideal as a drop in replacement for emitters with an industry standard 5.0mm x 5.0mm footprint.

Features

- Industry-standard 5050 footprint
- 3 bin color control enables tight color control
- Hot-color targeting ensures that color is within the ANSI bin at the typical application conditions of 85°C
- Enables 3- and 5-step MacAdam ellipse custom binning kits
- RoHS compliant and lead free
- Multiple CCT configurations for a wide range of lighting applications

Benefits

- Lower operating and manufacturing cost
- Ease of design and rapid go-to-market
- Uniform consistent white light
- Reliable and constant white point
- Environmentally friendly, complies with standards
- Design flexibility

Contents

Product Feature Map	2
Product Nomenclature	2
Product Test Conditions	2
Product Selection Guide	3
Performance at Commonly Used Drive Currents	4
Electrical Characteristics	6
Absolute Maximum Ratings	7
Product Bin Definitions	8
Performance Curves	11
Typical Radiation Pattern	14
Typical Color Spectrum	15
Mechanical Dimensions	16
Reliability	17
Reflowing Characteristics	18
Packaging	19
Design Resources	21
Precautions	21
Disclaimers	21
About Bridgelux	22

Product Feature Map

Bridgelux SMD LED products come in industry standard package sizes and follow ANSI binning standards. These LEDs are optimized for cost and performance, helping to ensure highly competitive system lumen per dollar performance while addressing the stringent efficacy and reliability standards required for modern lighting applications.

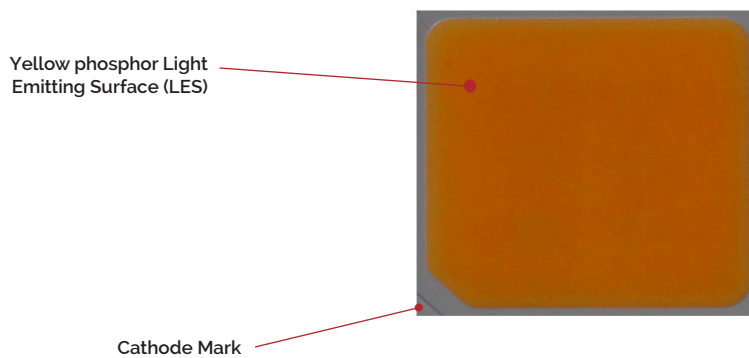

Product Nomenclature

The part number designation for Bridgelux SMD 5050 is explained as follows:

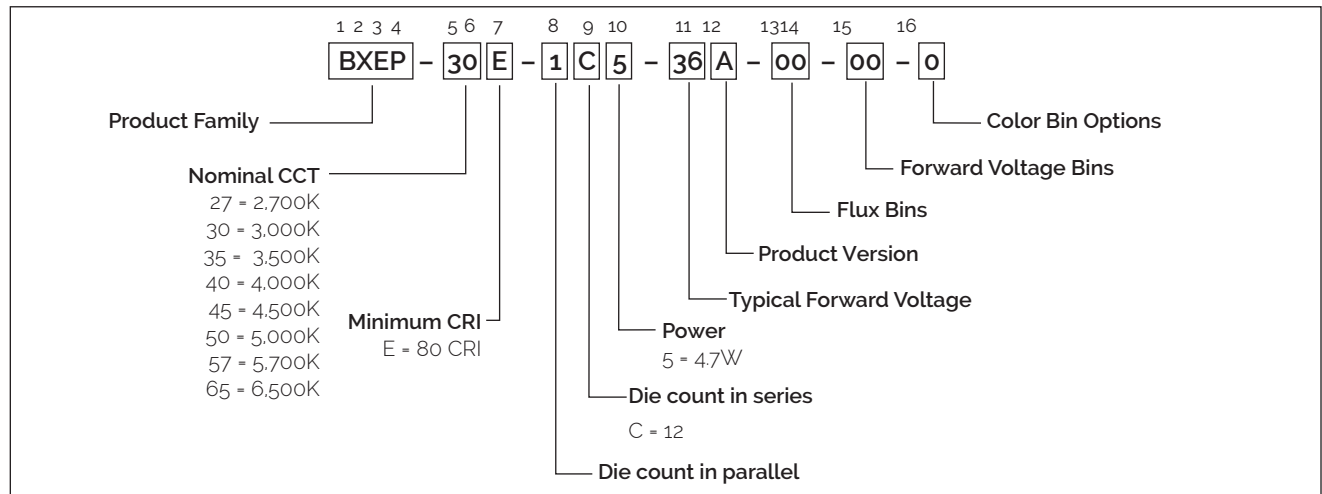

Product Test Conditions

Bridgelux SMD 5050 LEDs are tested and binned with a 10ms pulse of 125mA at T_j (junction temperature) = T_{sp} (solder point temperature) = 25°C. Forward voltage and luminous flux are binned at a $T_j = T_{sp} = 25^\circ\text{C}$, while color is hot targeted at a T_{sp} of 85°C.

Product Selection Guide

The following product configurations are available:

Table 1: Selection Guide, Pulsed Measurement Data at 125mA ($T_j = T_{sp} = 25^\circ\text{C}$)

Part Number ^{4,6}	Nominal CCT ² (K)	CRI ^{3,5}	Nominal Drive Current (mA)	Forward Voltage ^{4,5} (V)			Typical Pulsed Flux (lm) ^{4,5}	Typical Power (W)	Typical Efficacy (lm/W)
				Min	Typical	Max			
BXEP-27E-1C5-36A-00-00-0	2700	80	125	34	37.2	40.8	579	4.7	125
BXEP-30E-1C5-36A-00-00-0	3000	80	125	34	37.2	40.8	600	4.7	129
BXEP-35E-1C5-36A-00-00-0	3500	80	125	34	37.2	40.8	614	4.7	132
BXEP-40E-1C5-36A-00-00-0	4000	80	125	34	37.2	40.8	626	4.7	135
BXEP-45E-1C5-36A-00-00-0	4500	80	125	34	37.2	40.8	629	4.7	135
BXEP-50E-1C5-36A-00-00-0	5000	80	125	34	37.2	40.8	629	4.7	135
BXEP-57E-1C5-36A-00-00-0	5700	80	125	34	37.2	40.8	629	4.7	135
BXEP-65E-1C5-36A-00-00-0	6500	80	125	34	37.2	40.8	624	4.7	134

Table 2: Selection Guide, Stabilized DC Performance ($T_{sp} = 85^\circ\text{C}$)^{7,8}

Part Number ^{4,6}	Nominal CCT ² (K)	CRI ^{3,5}	Nominal Drive Current (mA)	Forward Voltage ⁵ (V)			Typical DC Flux (lm) ⁵	Typical Power (W)	Typical Efficacy (lm/W)
				Min	Typical	Max			
BXEP-27E-1C5-36A-00-00-0	2700	80	125	32.9	36.1	39.7	504	4.5	111
BXEP-30E-1C5-36A-00-00-0	3000	80	125	32.9	36.1	39.7	522	4.5	116
BXEP-35E-1C5-36A-00-00-0	3500	80	125	32.9	36.1	39.7	534	4.5	118
BXEP-40E-1C5-36A-00-00-0	4000	80	125	32.9	36.1	39.7	545	4.5	121
BXEP-45E-1C5-36A-00-00-0	4500	80	125	32.9	36.1	39.7	547	4.5	121
BXEP-50E-1C5-36A-00-00-0	5000	80	125	32.9	36.1	39.7	547	4.5	121
BXEP-57E-1C5-36A-00-00-0	5700	80	125	32.9	36.1	39.7	547	4.5	121
BXEP-65E-1C5-36A-00-00-0	6500	80	125	32.9	36.1	39.7	543	4.5	120

Notes for Table 1 & 2:

- The last 7 characters (including hyphens '-') refer to flux bins, forward voltage bins, and color bin options, respectively. "00-00-0" denotes the full distribution of flux, forward voltage, and 7 SDCM color.
Example: BXEP-30E-1C5-36A-00-00-0 refers to the full distribution of flux, forward voltage, and color within a 3000K 7-step ANSI standard chromaticity region with a minimum of 80CRI, 1x12 die configuration, 4.7w power, 37.2V typical forward voltage.
- Product CCT is hot targeted at $T_{sp} = 85^\circ\text{C}$. Nominal CCT as defined by ANSI C78.377-2011.
- Listed CRIs are minimum values and include test tolerance.
- Products tested under pulsed condition (10ms pulse width) at nominal drive current where $T_j = T_{sp} = 25^\circ\text{C}$.
- Bridgelux maintains a $\pm 7.5\%$ tolerance on luminous flux measurements, $\pm 0.1\text{V}$ tolerance on forward voltage measurements, and ± 2 tolerance on CRI measurements for the SMD 5050.
- Refer to Table 6 and Table 7 for Bridgelux SMD 5050 Luminous Flux Binning and Forward Voltage Binning information.
- Typical stabilized DC performance values are provided as reference only and are not a guarantee of performance.
- Typical performance is estimated based on operation under DC (direct current) with LED emitter mounted onto a heat sink with thermal interface material and the solder point temperature maintained at 85°C . Based on Bridgelux test setup, values may vary depending on the thermal design of the luminaire and/or the exposed environment to which the product is subjected.

Performance at Commonly Used Drive Currents

SMD 5050 LEDs are tested to the specifications shown using the nominal drive currents in Table 1. SMD 5050 may also be driven at other drive currents dependent on specific application design requirements. The performance at any drive current can be derived from the current vs. voltage characteristics shown in Figure 2 and the relative luminous flux vs. current characteristics shown in Figure 3. The performance at commonly used drive currents is summarized in Table 3.

Table 3: Performance at Commonly Used Drive Currents

Part Number	CRI	Drive Current ¹ (mA)	Typical V_f $T_{sp} = 25^\circ\text{C}$ (V)	Typical Power $T_{sp} = 25^\circ\text{C}$ (W)	Typical Pulsed Flux ² $T_{sp} = 25^\circ\text{C}$ (lm)	Typical DC Flux ³ $T_{sp} = 85^\circ\text{C}$ (lm)	Typical Efficacy $T_{sp} = 25^\circ\text{C}$ (lm/W)
BXEP-27E-1C5-36A-00-00-0	80	31	32.8	1.0	161	145	157
		63	34.5	2.2	311	277	145
		94	35.9	3.4	451	396	134
		125	37.2	4.7	579	504	125
		200	39.8	8.0	846	698	106
BXEP-30E-1C5-36A-00-00-0	80	31	32.8	1.0	167	150	163
		63	34.5	2.2	323	287	150
		94	35.9	3.4	467	410	139
		125	37.2	4.7	600	522	129
		200	39.8	8.0	877	724	110
BXEP-35E-1C5-36A-00-00-0	80	31	32.8	1.0	171	153	167
		63	34.5	2.2	330	294	153
		94	35.9	3.4	478	419	142
		125	37.2	4.7	614	534	132
		200	39.8	8.0	897	741	113
BXEP-40E-1C5-36A-00-00-0	80	31	32.8	1.0	174	156	170
		63	34.5	2.2	337	299	156
		94	35.9	3.4	488	428	145
		125	37.2	4.7	626	545	135
		200	39.8	8.0	915	755	115
BXEP-45E-1C5-36A-00-00-0	80	31	32.8	1.0	175	157	171
		63	34.5	2.2	338	301	157
		94	35.9	3.4	490	430	145
		125	37.2	4.7	629	547	135
		200	39.8	8.0	919	759	116

Notes for Table 3:

1. Alternate drive currents in Table 3 are provided for reference only and are not a guarantee of performance.
2. Bridgelux maintains a $\pm 7.5\%$ tolerance on flux measurements.
3. Typical stabilized DC performance values are provided as reference only and are not a guarantee of performance.

Performance at Commonly Used Drive Currents

Table 3: Performance at Commonly Used Drive Currents (Continued)

Part Number	CRI	Drive Current ¹ (mA)	Typical V_f $T_{sp} = 25^\circ\text{C}$ (V)	Typical Power $T_{sp} = 25^\circ\text{C}$ (W)	Typical Pulsed Flux ² $T_{sp} = 25^\circ\text{C}$ (lm)	Typical DC Flux ³ $T_{sp} = 85^\circ\text{C}$ (lm)	Typical Efficacy $T_{sp} = 25^\circ\text{C}$ (lm/W)
BXEP-50E-1C5-36A-00-00-0	80	31	32.8	1.0	175	157	171
		63	34.5	2.2	338	301	157
		94	35.9	3.4	490	430	145
		125	37.2	4.7	629	547	135
		200	39.8	8.0	919	759	116
BXEP-57E-1C5-36A-00-00-0	80	31	32.8	1.0	175	157	171
		63	34.5	2.2	338	301	157
		94	35.9	3.4	490	430	145
		125	37.2	4.7	629	547	135
		200	39.8	8.0	919	759	116
BXEP-65E-1C5-36A-00-00-0	80	31	32.8	1.0	174	156	169
		63	34.5	2.2	336	298	156
		94	35.9	3.4	486	426	144
		125	37.2	4.7	624	543	134
		200	39.8	8.0	912	753	115

Notes for Table 3:

1. Alternate drive currents in Table 3 are provided for reference only and are not a guarantee of performance.
2. Bridgelux maintains a $\pm 7.5\%$ tolerance on flux measurements.
3. Typical stabilized DC performance values are provided as reference only and are not a guarantee of performance.

Electrical Characteristics

Table 4: Electrical Characteristics

Part Number ¹	Drive Current (mA)	Forward Voltage (V) ^{2,3}			Typical Temperature Coefficient of Forward Voltage $\Delta V_f / \Delta T$ (mV/°C)	Typical Thermal Resistance Junction to Solder Point ⁴ R_{j-sp} (°C/W)
		Minimum	Typical	Maximum		
BXEP-xxE-1C5-36A-00-00-0	125	34.0	37.2	40.8	-17.6	1.9

Notes for Table 4:

- The last 7 characters (including hyphens '-') refer to flux bins, forward voltage bins, and color bin options, respectively. "00-00-0" denotes the full distribution of flux, forward voltage, and 7 SDCM color.
Example: BXEP-30E-1C5-36A-00-00-0 refers to the full distribution of flux, forward voltage, and color within a 3000K 7-step ANSI standard chromaticity region with a minimum of 80CRI, 1x12 die configuration, 4.7w power, 37.2V typical forward voltage.
- Bridgelux maintains a tolerance of $\pm 0.1V$ on forward voltage measurements. Voltage minimum and maximum values at the nominal drive current are guaranteed by 100% test.
- Products tested under pulsed condition (10ms pulse width) at nominal drive current where $T_{sp} = 25^{\circ}C$.
- Thermal resistance value was calculated using total electrical input power; optical power was not subtracted from input power.

Absolute Maximum Ratings

Table 5: Maximum Ratings

Parameter	Maximum Rating
LED Junction Temperature (T_j)	125°C
Storage Temperature	-40°C to +105°C
Operating Solder Point Temperature (T_{sp})	-40°C to +105°C
Soldering Temperature	260°C or lower for a maximum of 10 seconds
Maximum Drive Current	200mA
Maximum Peak Pulsed Forward Current ¹	240mA
Maximum Reverse Voltage	Bridgelux LEDs are not designed to be driven in reverse bias
Moisture Sensitivity Rating	MSL 3
Electrostatic Discharge	2kV HBM. JEDEC-JS-001-HBM and JEDEC-JS-001-2012

Notes for Table 5:

1. Bridgelux recommends a maximum duty cycle of 10% and pulse width of 10 ms when operating LED SMD at maximum peak pulsed current specified. Maximum peak pulsed current indicate values where LED SMD can be driven without catastrophic failures.

Product Bin Definitions

Table 6 lists the standard photometric luminous flux bins for Bridgelux SMD 5050 LEDs. Although several bins are listed, product availability in a particular bin varies by production run and by product performance. Not all bins are available in all CCTs.

Table 6: Luminous Flux Bin Definitions at 125mA, $T_{sp}=25^{\circ}\text{C}$

Bin Code	Minimum	Maximum	Unit	Condition
A8	505	545	lm	$I_F=125\text{mA}$
A9	545	590		
B1	590	635		
B2	635	685		
B3	685	740		
B4	740	800		
B5	800	865		

Note for Table 6:

1. Bridgelux maintains a tolerance of $\pm 7.5\%$ on luminous flux measurements.

Table 7: Forward Voltage Bin Definition at 125mA, $T_{sp}=25^{\circ}\text{C}$

Bin Code	Minimum	Maximum	Unit	Condition
MD	33.5	35.0	V	$I_F=125\text{mA}$
ME	35.0	36.5		
MF	36.5	38.0		
MG	38.0	39.5		
MH	39.5	41.0		

Note for Table 7:

1. Bridgelux maintains a tolerance of $\pm 0.1\text{V}$ on forward voltage measurements.

Product Bin Definitions

Table 8: 3- and 5-step MacAdam Ellipse Color Bin Definitions

CCT	Color Space	Center Point		Major Axis	Minor Axis	Ellipse Rotation Angle	Color Bin
		X	Y				
2700K	3 SDCM	0.4578	0.4101	0.00810	0.00420	53.70	3
	5 SDCM	0.4578	0.4101	0.01350	0.00700	53.70	5
3000K	3 SDCM	0.4338	0.4030	0.00834	0.00408	53.22	3
	5 SDCM	0.4338	0.4030	0.01390	0.00680	53.22	5
3500K	3 SDCM	0.4103	0.3961	0.00927	0.00414	54.00	3
	5 SDCM	0.4103	0.3961	0.01545	0.00690	54.00	5
4000K	3 SDCM	0.3818	0.3797	0.00939	0.00402	53.72	3
	5 SDCM	0.3818	0.3797	0.01565	0.00670	53.72	5
4500K	3 SDCM	0.3611	0.3658	0.00756	0.00338	57.58	3
	5 SDCM	0.3611	0.3658	0.01260	0.00563	57.58	5
5000K	3 SDCM	0.3447	0.3553	0.00822	0.00354	59.62	3
	5 SDCM	0.3447	0.3553	0.01370	0.00590	59.62	5
5700K	3 SDCM	0.3287	0.3417	0.00746	0.00320	59.09	3
	5 SDCM	0.3287	0.3417	0.01243	0.00533	59.09	5
6500K	3 SDCM	0.3123	0.3282	0.00669	0.00285	58.57	3
	5 SDCM	0.3123	0.3282	0.01115	0.00475	58.57	5

Notes for Table 8:

1. Color binning at $T_{sp}=85^{\circ}\text{C}$
2. Bridgelux maintains a tolerance of ± 0.007 on x and y color coordinates in the CIE 1931 color space.

Product Bin Definitions

Figure 1: C.I.E. 1931 Chromaticity Diagram (3 Color Bin Structure, hot-color targeted at $T_{sp} = 85^{\circ}\text{C}$)

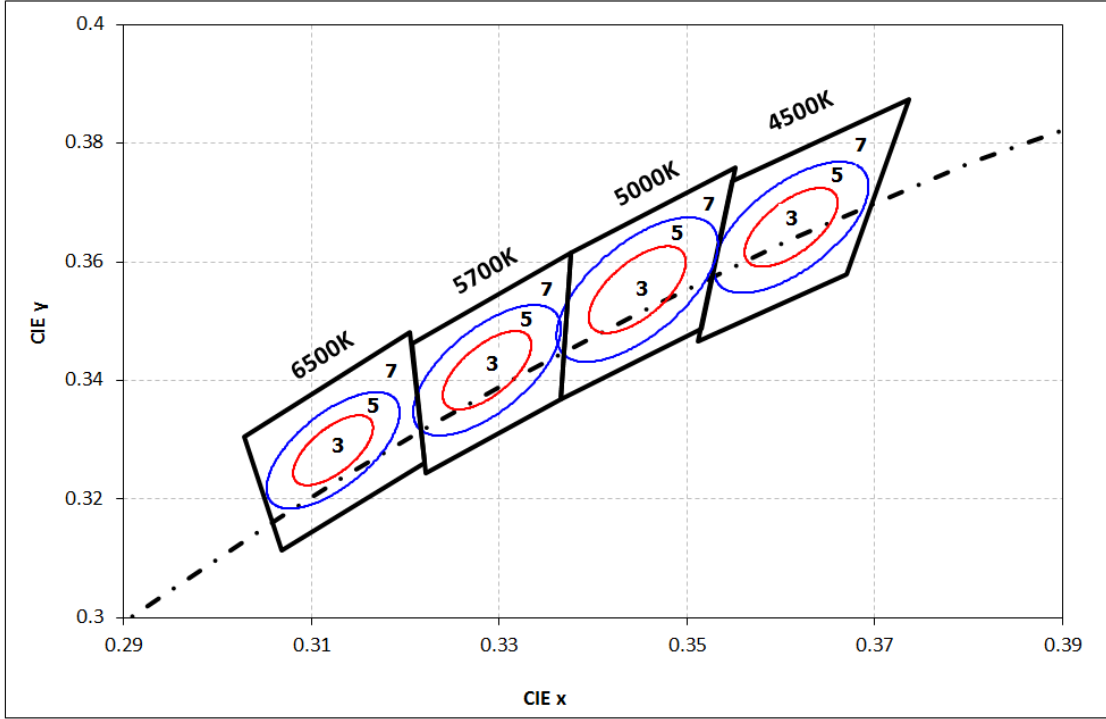
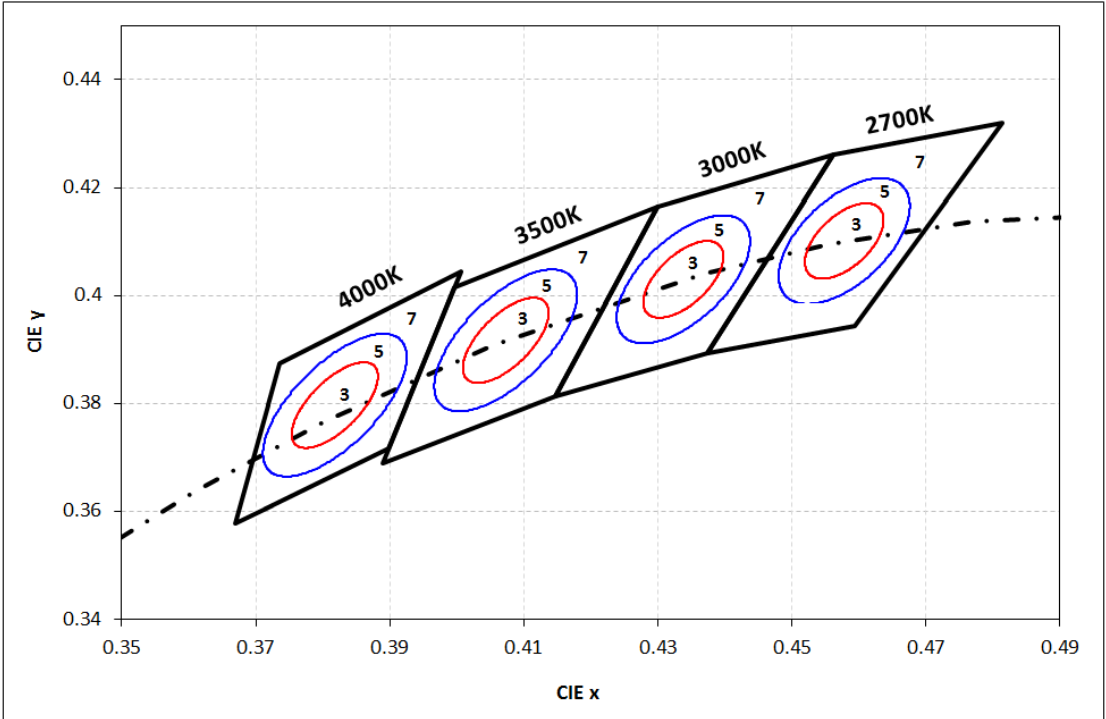

Performance Curves

Figure 2: Drive Current vs. Voltage ($T_{sp}=25^{\circ}\text{C}$)

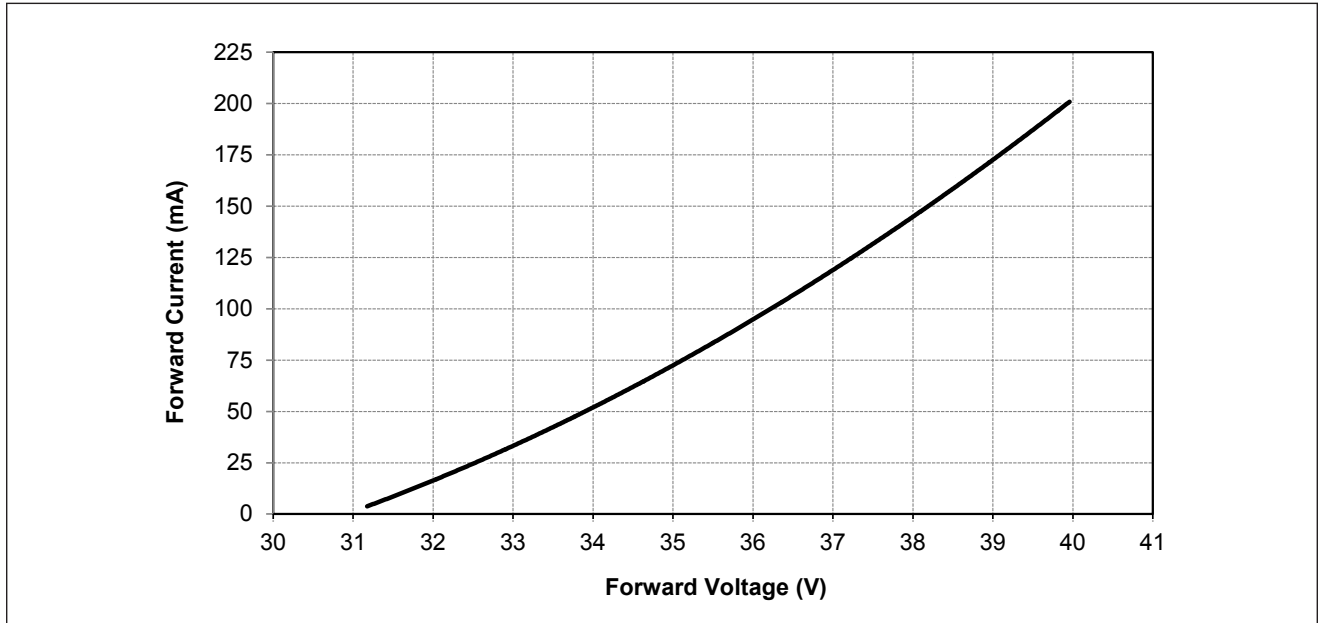
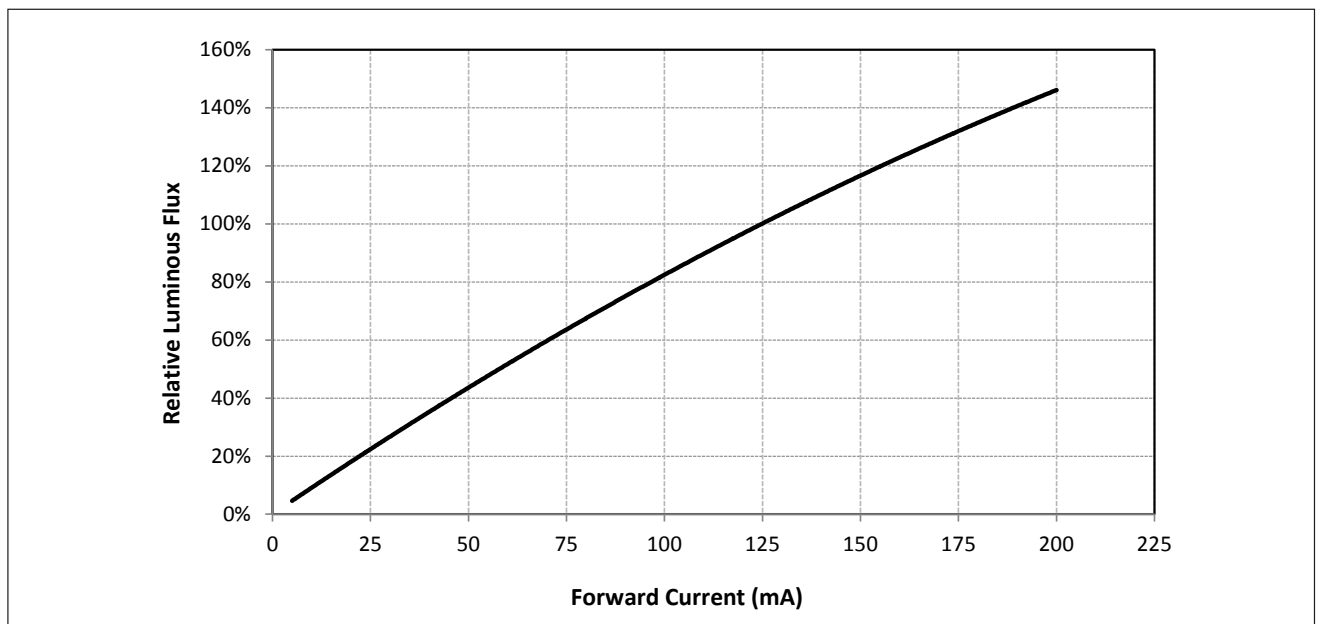

Figure 3: Typical Relative Luminous Flux vs. Drive Current ($T_{sp}=25^{\circ}\text{C}$)



Note for Figure 3:

1. Bridgelux does not recommend driving high power LEDs at low currents. Doing so may produce unpredictable results. Pulse width modulation (PWM) is recommended for dimming effects.

Performance Curves

Figure 4: Typical Relative DC Flux vs. Solder Point Temperature

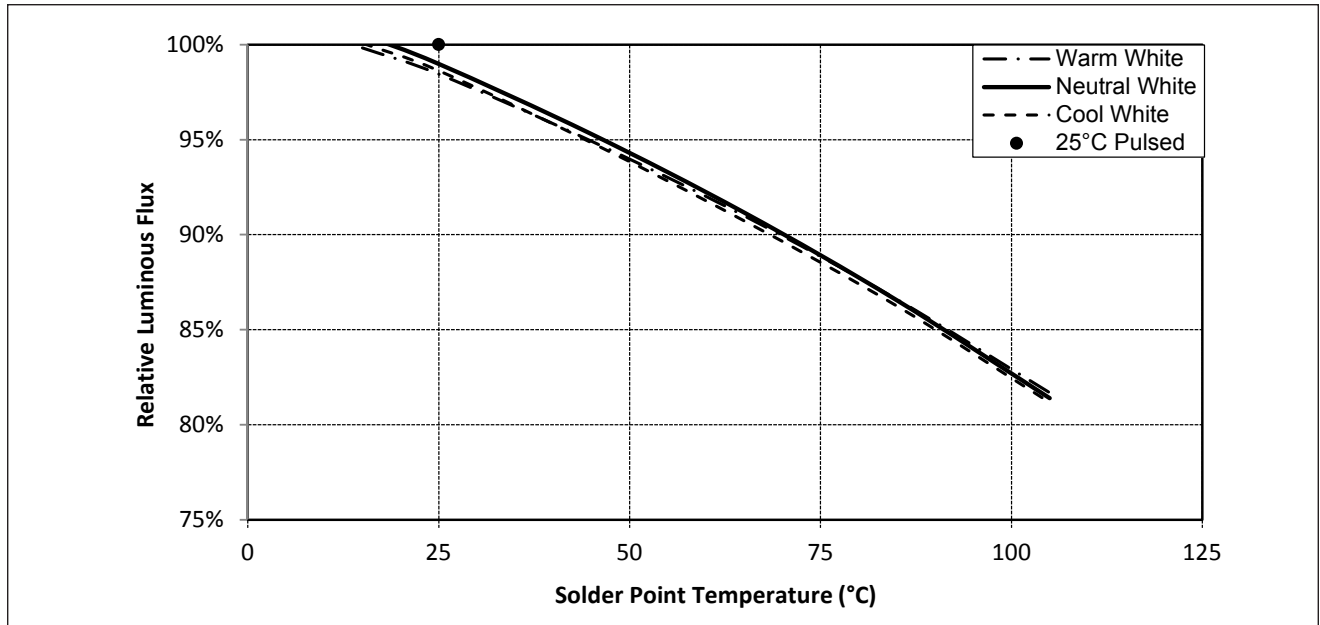
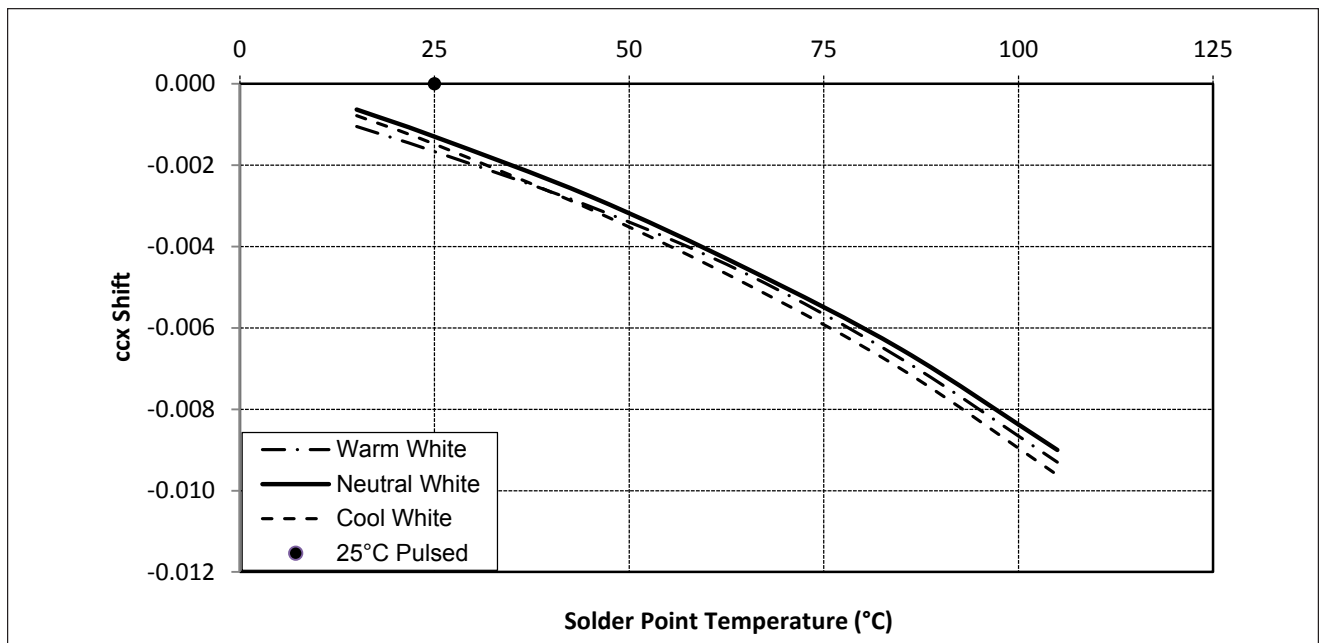

Figure 5: Typical DC ccx Shift vs. Solder Point Temperature



Notes for Figures 4 & 5:

1. Characteristics shown for warm white based on 3000K and 80 CRI.
2. Characteristics shown for neutral white based on 4000K and 80 CRI.
3. Characteristics shown for cool white based on 5000K and 80 CRI.
4. For other color SKUs, the shift in color will vary. Please contact your Bridgelux Sales Representative for more information.

Performance Curves

Figure 6: Typical DC ccy Shift vs. Solder Point Temperature

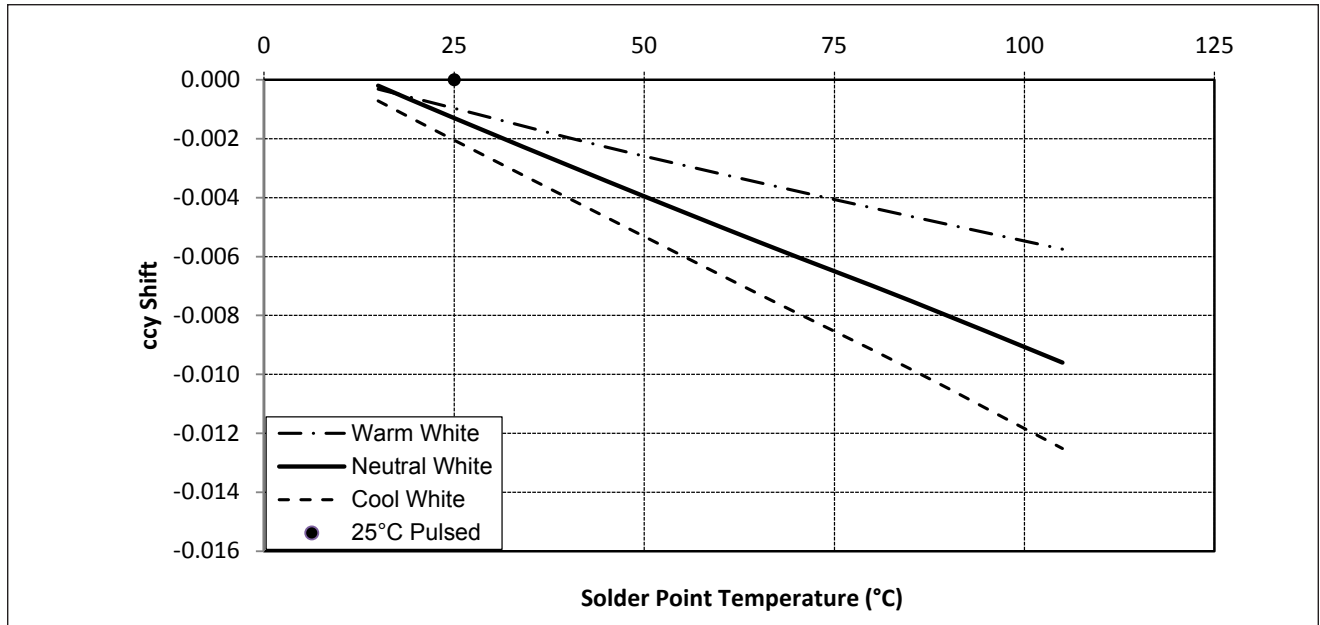

Notes for Figure 6:

1. Characteristics shown for warm white based on 3000K and 80 CRI.
2. Characteristics shown for neutral white based on 4000K and 80 CRI.
3. Characteristics shown for cool white based on 5000K and 80 CRI.
4. For other color SKUs, the shift in color will vary. Please contact your Bridgelux Sales Representative for more information.

Typical Radiation Pattern

Figure 7: Typical Spatial Radiation Pattern at 125mA, $T_{sp}=25^{\circ}\text{C}$

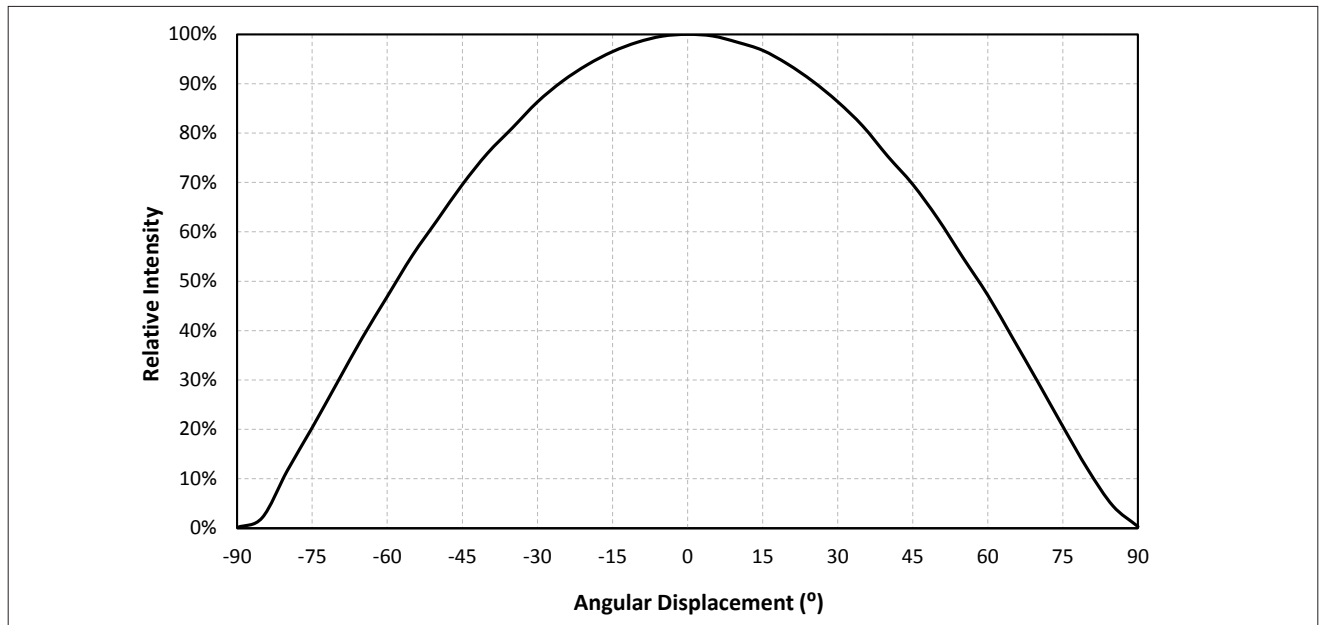

Notes for Figure 7:

1. Typical viewing angle is 116° .
2. The viewing angle is defined as the off axis angle from the centerline where luminous intensity (lv) is $\frac{1}{2}$ of the peak value.

Figure 8: Typical Polar Radiation Pattern at 125mA, $T_{sp}=25^{\circ}\text{C}$

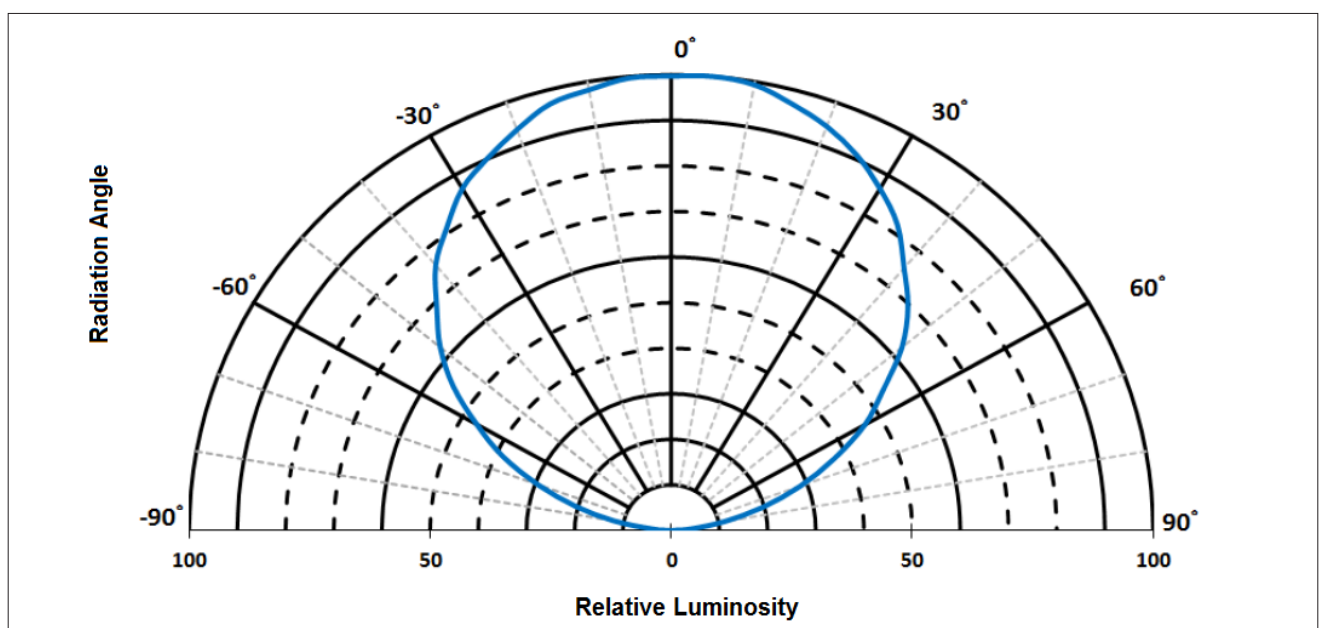

Typical Color Spectrum

Figure 9: Typical Color Spectrum

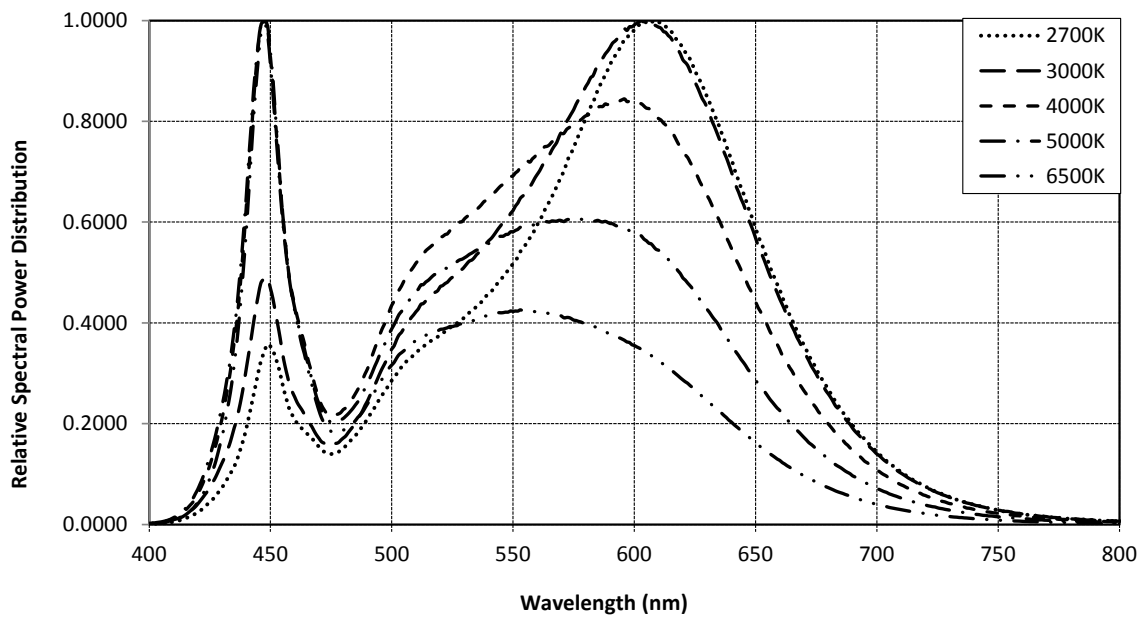

Notes for Figure 9:

1. Color spectra measured at nominal current for $T_{sp} = 25^{\circ}\text{C}$
2. Color spectra shown for warm white is 2700K and 80 CRI.
3. Color spectra shown for warm white is 3000K and 80 CRI.
4. Color spectra shown for neutral white is 4000K and 80 CRI.
5. Color spectra shown for cool white is 5000K and 80 CRI.
6. Color spectra shown for cool white is 6500K and 80 CRI.

Mechanical Dimensions

Figure 10: Drawing for SMD 5050

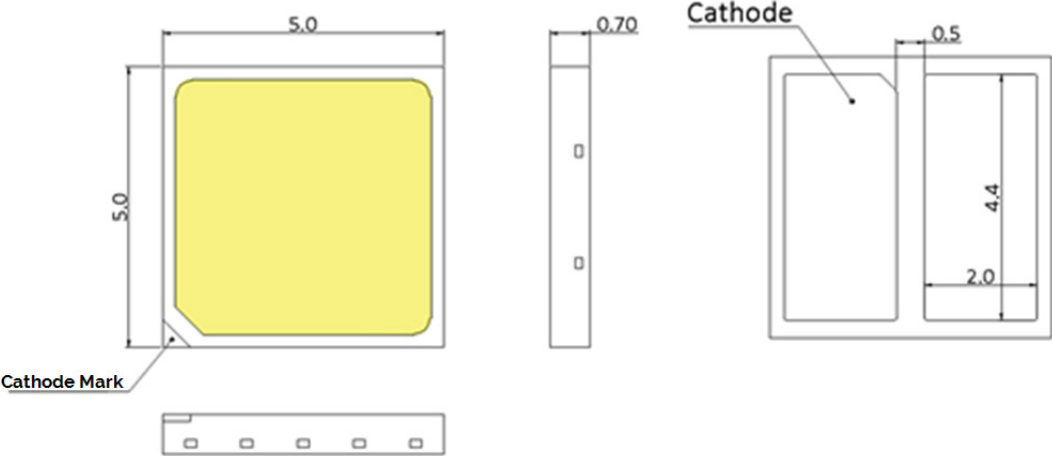

- Notes for Figure 10:
- 1. Drawings are not to scale.
 - 2. Drawing dimensions are in millimeters.
 - 3. Unless otherwise specified, tolerances are $\pm 0.10\text{mm}$.

Recommended PCB Soldering Pad Pattern

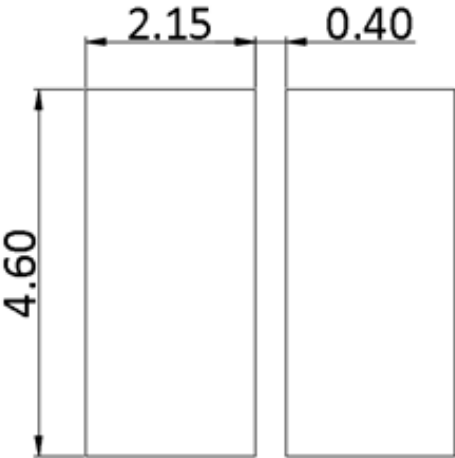

Reliability

Table 9: Reliability Test Items and Conditions

No .	Items	Reference Standard	Test Conditions	Drive Current	Test Duration	Units Failed/Tested
1	Moisture/Reflow Sensitivity	J-STD-020E	$T_{sld} = 260^{\circ}\text{C}$, 10sec, Precondition: 60°C , 60%RH, 168hr	-	3 reflows	0/22
2	Low Temperature Storage	JESD22-A119	$T_a = -40^{\circ}\text{C}$	-	1000 hours	0/22
3	High Temperature Storage	JESD22-A103D	$T_a = 105^{\circ}\text{C}$	-	1000 hours	0/22
4	Low Temperature Operating Life	JESD22-A108D	$T_a = -40^{\circ}\text{C}$	125mA	1000 hours	0/22
5	Temperature Humidity Operating Life	JESD22-A101C	$T_{sp} = 85^{\circ}\text{C}$, RH=85%	125mA	1000 hours	0/22
6	High Temperature Operating Life	JESD22-A108D	$T_{sp} = 105^{\circ}\text{C}$	160mA	1000 hours	0/22
7	Power switching	IEC62717:2014	$T_{sp} = 105^{\circ}\text{C}$ 30 sec on, 30 sec off	160mA	30000 cycles	0/22
8	Thermal Shock	JESD22-A106B	$T_a = -40^{\circ}\text{C} \sim 100^{\circ}\text{C}$; Dwell : 15min; Transfer: 10sec	-	200 cycles	0/22
9	Temperature Cycle	JESD22-A104E	$T_a = -40^{\circ}\text{C} \sim 100^{\circ}\text{C}$; Dwell at extreme temperature: 15min; Ramp rate < $105^{\circ}\text{C}/\text{min}$	-	200 cycles	0/22
10	Electrostatic Discharge	JS-001-2012	HBM, 2kV, 15k Ω , 100pF, Alternately positive or negative	-	-	0/22

Passing Criteria

Item	Symbol	Test Condition	Passing Criteria
Forward Voltage	Vf	125mA	$\Delta V_f < 10\%$
Luminous Flux	Fv	125mA	$\Delta F_v < 30\%$
Chromaticity Coordinates	(x, y)	125mA	$\Delta u'v' < 0.007$

Notes for Table 9:

1. Measurements are performed after allowing the LEDs to return to room temperature
2. T_{sld} : reflow soldering temperature; T_a : ambient temperature

Reflowing Characteristics

Figure 11 : Reflow Profile

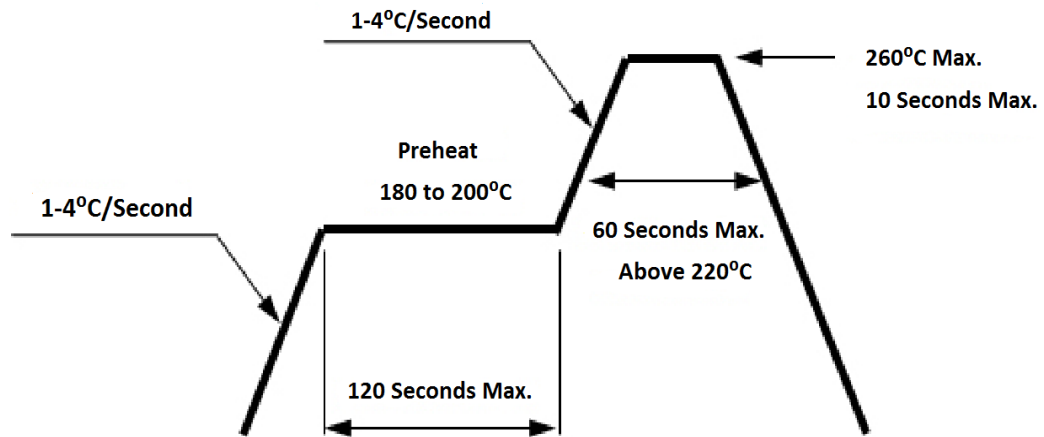

Profile Feature	Lead Free Assembly
Preheat: Temperature Range	180°C – 200°C
Preheat: Time (Maximum)	120 seconds
Peak Temperature	260°C
Soldering Time (Maximum)	10 seconds
Allowable Reflow Cycles	2

Figure 12 : Pick and Place

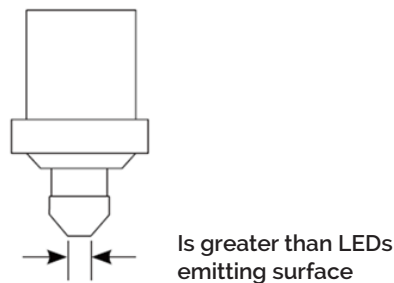

Note for Figure 12:

1. When using a pick and place machine, choose a nozzle that has a larger diameter than the LED's emitting surface. Using a Pick-and-Place nozzle with a smaller diameter than the size of the LEDs emitting surface will cause damage and may also cause the LED to not illuminate.

Packaging

Figure 13: Emitter Reel Drawings

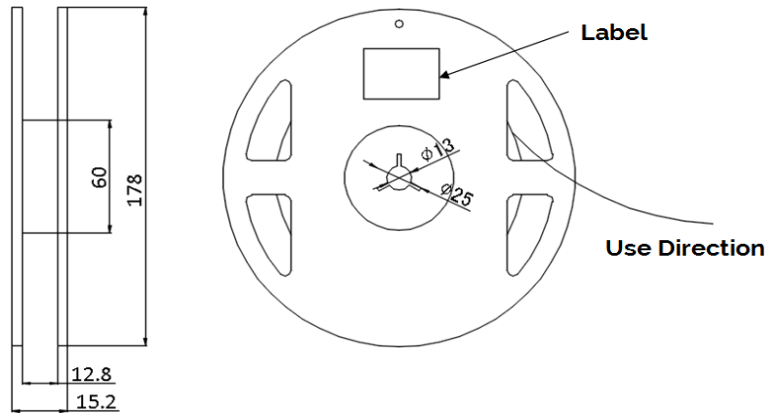

Note for Figure 13:

1. Drawings are not to scale. Drawing dimensions are in millimeters.

Figure 14: Emitter Tape Drawings

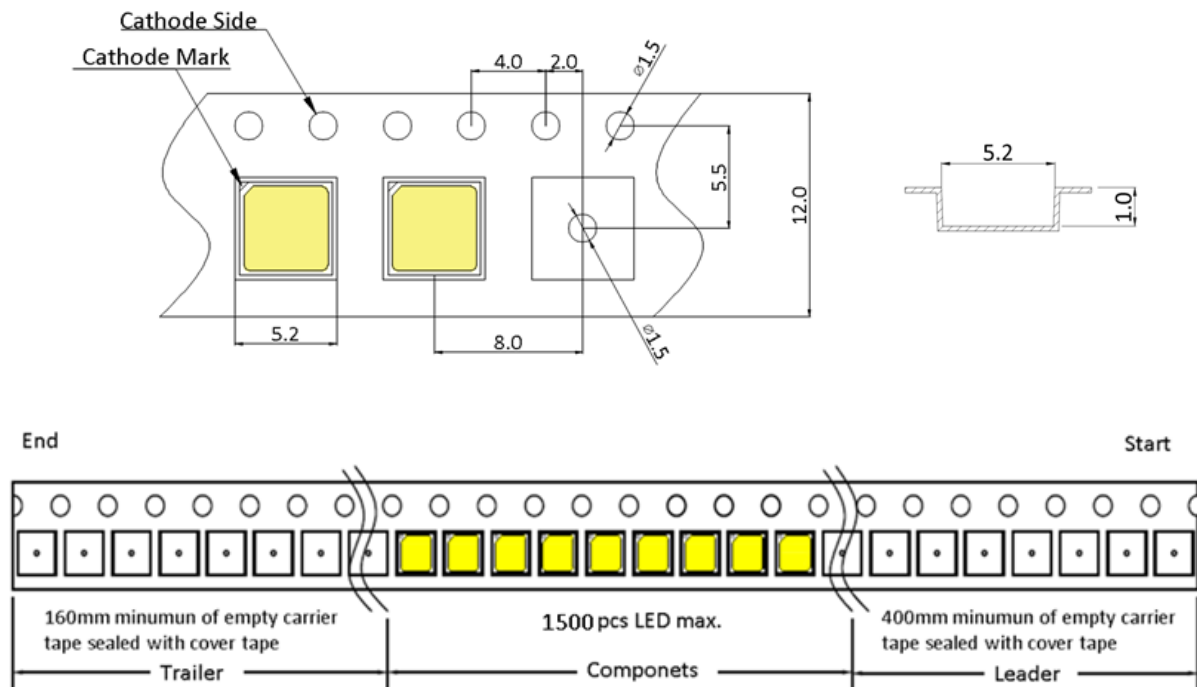

Note for Figure 14:

1. Drawings are not to scale. Drawing dimensions are in millimeters.

Packaging

Figure 15: Emitter Reel Packaging Drawings

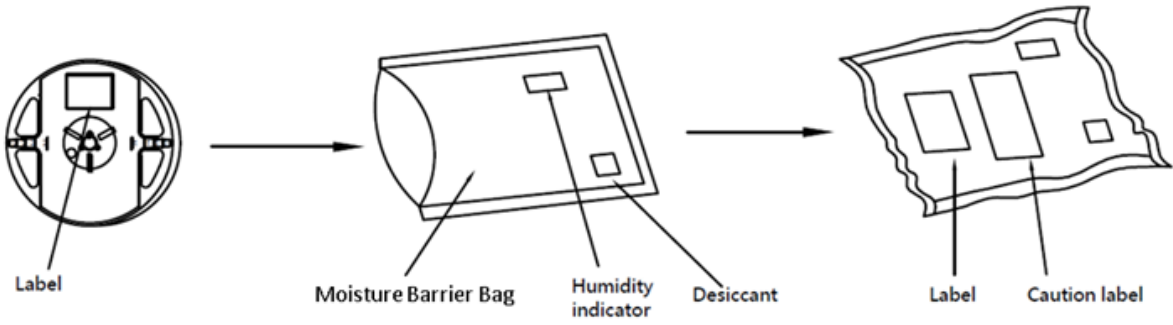

Note for Figure 15:
1. Drawings are not to scale.

Design Resources

Please contact your Bridgelux sales representative for assistance.

Precautions

CAUTION: CHEMICAL EXPOSURE HAZARD

Exposure to some chemicals commonly used in luminaire manufacturing and assembly can cause damage to the LED emitter. Please consult Bridgelux Application Note AN51 for additional information.

CAUTION: EYE SAFETY

This SMD package emits visible light, that, under certain circumstances, could be harmful to the eye. Proper safeguards must be used.

CAUTION: RISK OF BURN

Do not touch the SMD LED emitter during operation. Allow the emitter to cool for a sufficient period of time before handling. The SMD LED emitter may reach elevated temperatures such that could burn skin when touched.

CAUTION

CONTACT WITH LIGHT EMITTING SURFACE (LES)

Avoid any contact with the LES. Do not touch the LES of the emitter or apply stress to the LES (yellow phosphor resin area). Contact may cause damage to the emitter

Optics and reflectors must not be mounted in contact with the LES (yellow phosphor resin area).

Disclaimers

MINOR PRODUCT CHANGE POLICY

The rigorous qualification testing on products offered by Bridgelux provides performance assurance. Slight cosmetic changes that do not affect form, fit, or function may occur as Bridgelux continues product optimization.

STANDARD TEST CONDITIONS

Unless otherwise stated, LED emitter testing is performed at the nominal drive current.

About Bridgelux: We Build Light That Transforms

At Bridgelux, we help companies, industries and people experience the power and possibility of light. Since 2002, we've designed LED solutions that are high performing, energy efficient, cost effective and easy to integrate. Our focus is on light's impact on human behavior, delivering products that create better environments, experiences and returns—both experiential and financial. And our patented technology drives new platforms for commercial and industrial luminaires.

For more information about the company, please visit
bridgelux.com
twitter.com/Bridgelux
facebook.com/Bridgelux
WeChat ID: BridgeluxinChina



101 Portola Avenue
Livermore, CA 94551
Tel (925) 583-8400
Fax (925) 583-8401
www.bridgelux.com

© 2016 Bridgelux, Inc. All rights reserved 2016. Product specifications are subject to change without notice. Bridgelux and the Bridgelux stylized logo design are registered trademarks of Bridgelux, Inc. All other trademarks are the property of their respective owners.