

SPECIFICATION PATENTED

Part No. : **TG.30.8113**

Product Name : Apex Hinged TG.30
Ultra-Wideband 4G LTE Antenna

Feature : LTE / GSM / CDMA /DCS /PCS / WCDMA / UMTS /
HSDPA / GPRS / EDGE /GPS /Wi-Fi
698MHz to 960MHz, 1575.42MHz
1710MHz to 2700Mhz
Typical 70%+ Efficiency and 3dBi+ Peak Gain
Dipole Swivel Terminal Antenna
Hinged 90° termination with SMA(M) Connector
RoHS Compliant



1. Introduction

The hinged Apex TG.30 Ultra-Wideband Dipole LTE Antenna – is primarily designed for use with 4G LTE modules and devices that require the highest possible efficiency and peak gain to deliver best in class throughput on all major cellular (2g/3g/4g) bands worldwide for access points, terminals and routers. The antenna is a ground plane independent antenna with a SMA (M) connector and swivel mechanism that allows the antenna part to be rotated. The Apex exhibits high efficiency across the ultra wide band and is backward compatible with 2G and 3G cellular applications such as GSM, LTE, UMTS, WI-FI and even has GPS included for Assisted GPS and/or E911 applications. With very high efficiency on every cellular band globally it is an ideal solution for any device requiring high, reliable performance. It is also guaranteed to meet any type approval or carrier certification requirements from a RF standpoint. It is an omni-directional antenna and the radiation patterns display this and are stable across all bands.

It has a quality robust IP67 UV resistant housing (SMA connector is IP65) for use with wireless terminals. The swivel and hinge mechanism allows the antenna part itself to be orientated in different directions and can help avoid touching off other antennas or objects close by as well as helping with isolation by orientating the antenna in different directions in MIMO systems for when other TG.30 antennas are present on the same device.

This patented antenna is available in White and Black versions. The antenna blade can swivel 90 degrees from the connector accommodating different installation environments. It is also available with Straight and Right Angle connectors.

2. Specification

| ELECTRICAL | | | | | | | |
|-------------------------------|---------|---------|---------|-------------|-------------|-------------|-----------|
| Frequency (MHz) | 700~800 | 824~960 | 1575.42 | 1710 ~ 1880 | 1850 ~ 1990 | 1710 ~ 2170 | 2400~2800 |
| Peak Gain (dBi) | | | | | | | |
| Free Space Straight | 1.1 | 0.3 | 1.1 | 1.9 | 2.7 | 2.6 | 2.7 |
| Free Space Bent | 2.6 | 1.5 | 2.9 | 2.7 | 3.1 | 3.1 | 2.0 |
| 30x30cm GP center Straight | 2.1 | 0.7 | 2.9 | 1.5 | 1.9 | 2.0 | 2.9 |
| 30x30cm GP center Bent | 3.5 | 1.7 | 5.2 | 5.9 | 6.7 | 6.4 | 4.9 |
| 30x30cm GP edge Straight | 2.6 | 1.3 | 1.7 | 2.1 | 2.1 | 2.3 | 4.3 |
| 30x30cm GP edge Bent | 2.6 | 1.8 | 3.1 | 2.1 | 3.0 | 2.8 | 5.1 |
| PCB edge Straight | 1.4 | 1.2 | 0.9 | 2.5 | 3.2 | 3.0 | 1.4 |
| PCB edge Bent | 2.1 | 0.1 | 2.1 | 2.4 | 3.6 | 3.4 | 3.0 |
| Average Gain (dB) | | | | | | | |
| Free Space Straight | -1.1 | -2.2 | -2.0 | -1.5 | -1.2 | -1.3 | -3.5 |
| Free Space Bent | -1.1 | -2.3 | -1.5 | -1.5 | -1.1 | -1.2 | -3.1 |
| 30x30cm GP center Straight | -0.6 | -1.6 | -2.0 | -1.8 | -1.7 | -1.7 | -3.8 |
| 30x30cm GP center Bent | -3.5 | -4.9 | -2.8 | -2.4 | -1.8 | -2.0 | -3.0 |
| 30x30cm GP edge Straight | -0.6 | -1.5 | -1.9 | -1.6 | -1.4 | -1.4 | -3.1 |
| 30x30cm GP edge Bent | -0.6 | -1.7 | -1.6 | -1.5 | -1.2 | -1.3 | -3.1 |
| PCB edge Straight | -1.0 | -2.0 | -2.0 | -1.6 | -1.4 | -1.4 | -3.5 |
| PCB edge Bent | -0.8 | -2.5 | -1.6 | -1.5 | -1.1 | -1.3 | -3.0 |

| ELECTRICAL | | | | | | | |
|-------------------------------|----------------------------|---------|---------|-------------|-------------|-------------|-----------|
| Frequency (MHz) | 700~800 | 824~960 | 1575.42 | 1710 ~ 1880 | 1850 ~ 1990 | 1710 ~ 2170 | 2400~2800 |
| Efficiency (%) | | | | | | | |
| Free Space Straight | 79 | 61 | 63 | 71 | 76 | 75 | 45 |
| Free Space Bent | 78 | 60 | 70 | 72 | 78 | 75 | 49 |
| 30x30cm GP center Straight | 86 | 69 | 62 | 66 | 67 | 68 | 42 |
| 30x30cm GP center Bent | 47 | 32 | 51 | 58 | 66 | 64 | 51 |
| 30x30cm GP edge Straight | 88 | 70 | 65 | 69 | 72 | 72 | 49 |
| 30x30cm GP edge Bent | 88 | 67 | 69 | 70 | 76 | 74 | 49 |
| PCB edge Straight | 80 | 63 | 63 | 69 | 73 | 73 | 45 |
| PCB edge Bent | 83 | 57 | 70 | 71 | 77 | 75 | 50 |
| Impedance | 50Ω | | | | | | |
| Polarization | Linear | | | | | | |
| Radiation Pattern | Omni | | | | | | |
| Input Power | 10 W | | | | | | |
| MECHANICAL | | | | | | | |
| Casing | UV Resistant PC/ABS | | | | | | |
| Connector | SMA Male Hinged 90° | | | | | | |
| ENVIRONMENTAL | | | | | | | |
| Temperature Range | -40°C to 85°C | | | | | | |
| Humidity | Non-condensing 65°C 95% RH | | | | | | |

| LTE BANDS | | | |
|-------------|--|-------------------------------|---------|
| Band Number | LTE / LTE-Advanced / WCDMA / HSPA / HSPA+ / TD-SCDMA | | |
| | Uplink | Downlink | Covered |
| 1 | UL: 1920 to 1980 | DL: 2110 to 2170 | ✓ |
| 2 | UL: 1850 to 1910 | DL: 1930 to 1990 | ✓ |
| 3 | UL: 1710 to 1785 | DL: 1805 to 1880 | ✓ |
| 4 | UL: 1710 to 1755 | DL: 2110 to 2155 | ✓ |
| 5 | UL: 824 to 849 | DL: 869 to 894 | ✓ |
| 7 | UL: 2500 to 2570 | DL: 2620 to 2690 | ✓ |
| 8 | UL: 880 to 915 | DL: 925 to 960 | ✓ |
| 9 | UL: 1749.9 to 1784.9 | DL: 1844.9 to 1879.9 | ✓ |
| 11 | UL: 1427.9 to 1447.9 | DL: 1475.9 to 1495.9 | ✗ |
| 12 | UL: 699 to 716 | DL: 729 to 746 | ✓ |
| 13 | UL: 777 to 787 | DL: 746 to 756 | ✓ |
| 14 | UL: 788 to 798 | DL: 758 to 768 | ✓ |
| 17 | UL: 704 to 716 | DL: 734 to 746 (LTE only) | ✓ |
| 18 | UL: 815 to 830 | DL: 860 to 875 (LET only) | ✓ |
| 19 | UL: 830 to 845 | DL: 875 to 890 | ✓ |
| 20 | UL: 832 to 862 | DL: 791 to 821 | ✓ |
| 21 | UL: 1447.9 to 1462.9 | DL: 1495.9 to 1510.9 | ✗ |
| 22 | UL: 3410 to 3490 | DL: 3510 to 3590 | ✗ |
| 23 | UL: 2000 to 2020 | DL: 2180 to 2200 (LTE only) | ✓ |
| 24 | UL: 1625.5 to 1660.5 | DL: 1525 to 1559 (LTE only) | ✓ |
| 25 | UL: 1850 to 1915 | DL: 1930 to 1995 | ✓ |
| 26 | UL: 814 to 849 | DL: 859 to 894 | ✓ |
| 27 | UL: 807 to 824 | DL: 852 to 869 (LTE only) | ✓ |
| 28 | UL: 703 to 748 | DL: 758 to 803 (LTE only) | ✓ |
| 29 | UL: - | DL: 717 to 728 (LTE only) | ✓ |
| 30 | UL: 2305 to 2315 | DL: 2350 to 2360 (LTE only) | ✓ |
| 31 | UL: 452.5 to 457.5 | DL: 462.5 to 467.5 (LTE only) | ✗ |
| 32 | UL: - | DL: 1452 - 1496 | ✗ |
| 35 | | 1850 to 1910 | ✓ |
| 38 | | 2570 to 2620 | ✓ |
| 39 | | 1880 to 1920 | ✓ |
| 40 | | 2300 to 2400 | ✓ |
| 41 | | 2496 to 2690 | ✓ |
| 42 | | 3400 to 3600 | ✗ |
| 43 | | 3600 to 3800 | ✗ |

3. Antenna Characteristics

3.1 Return Loss

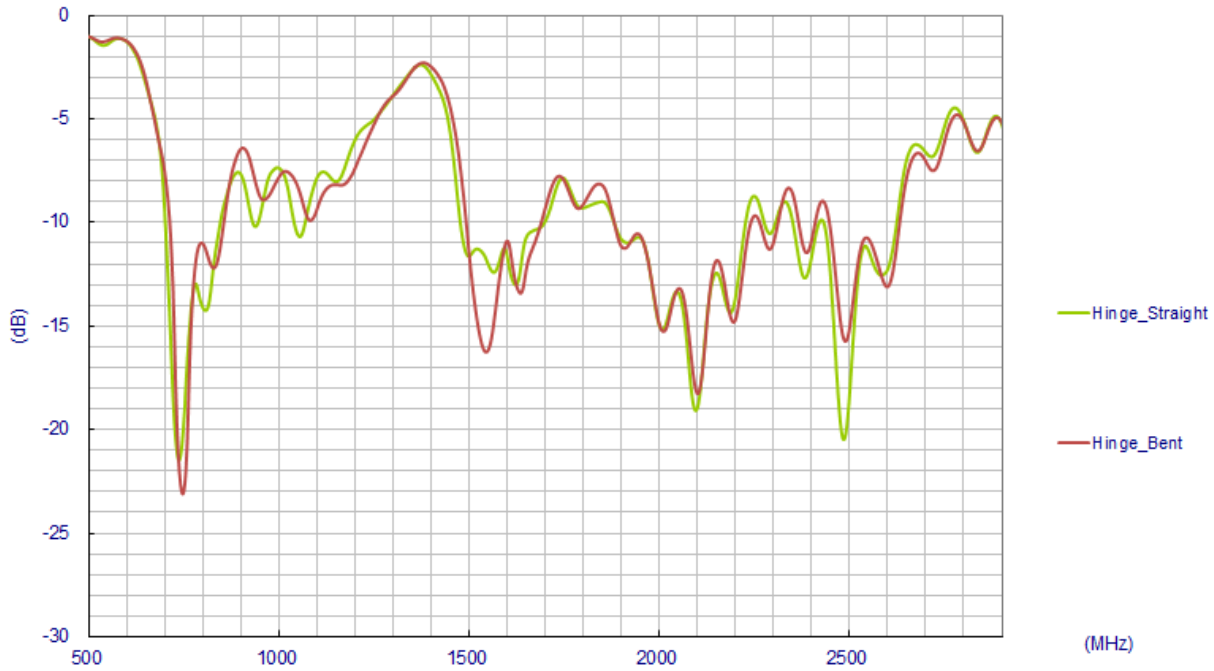

3.2 Peak Gain

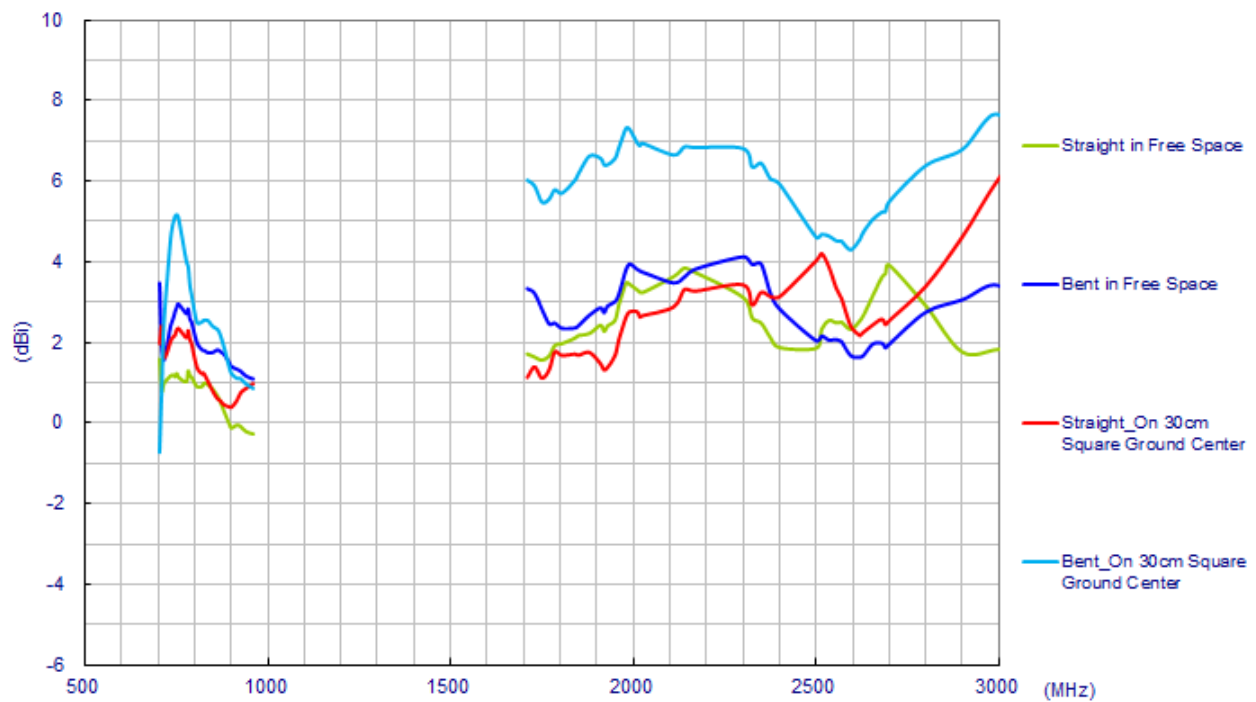

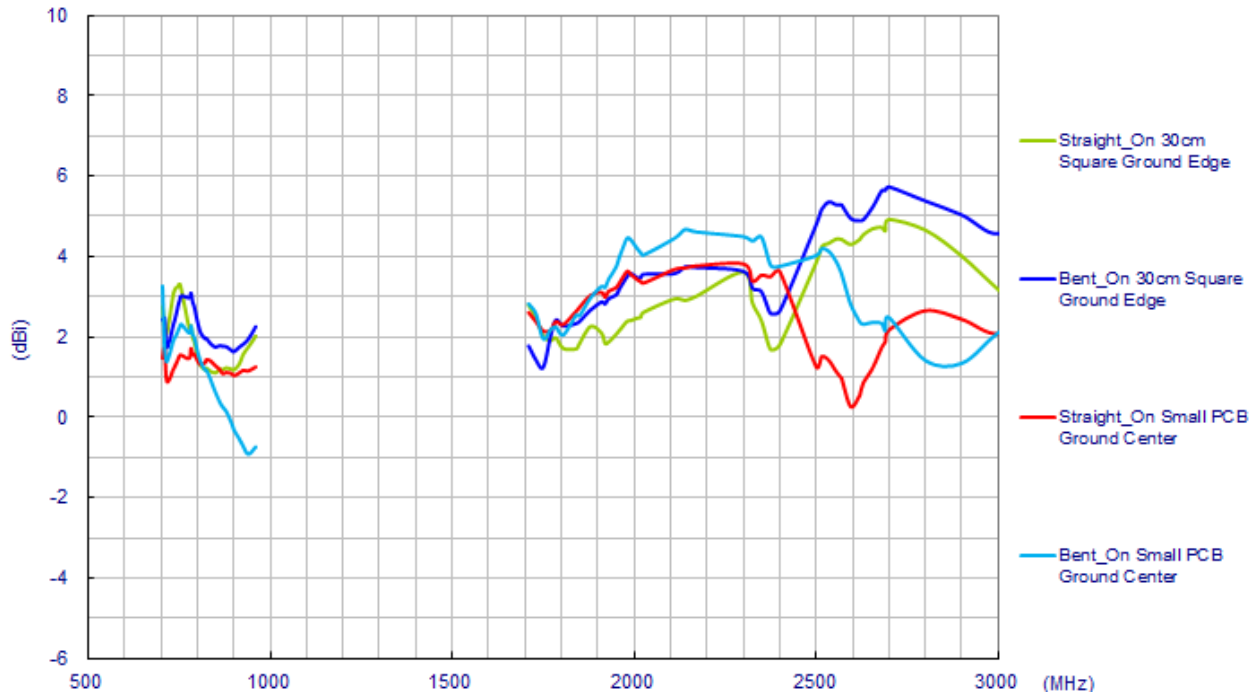

3.3 Average Gain

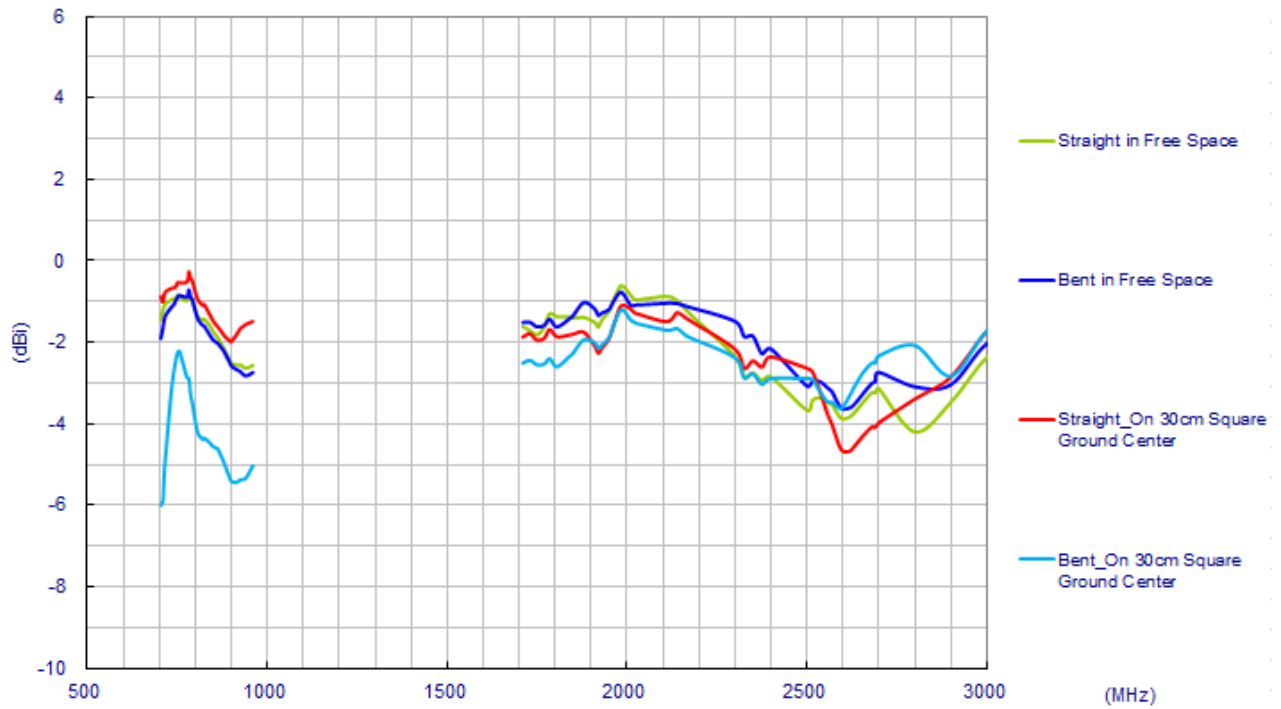

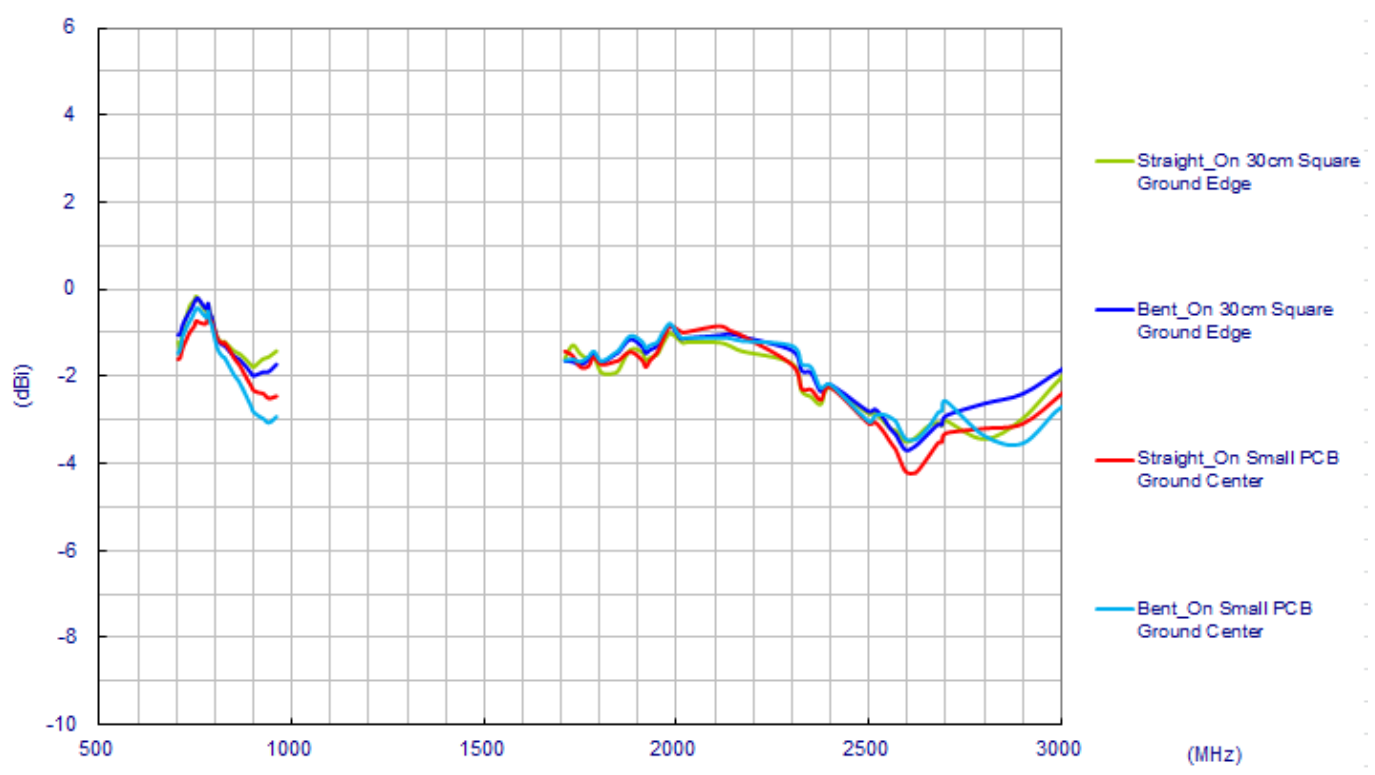

3.4 Efficiency

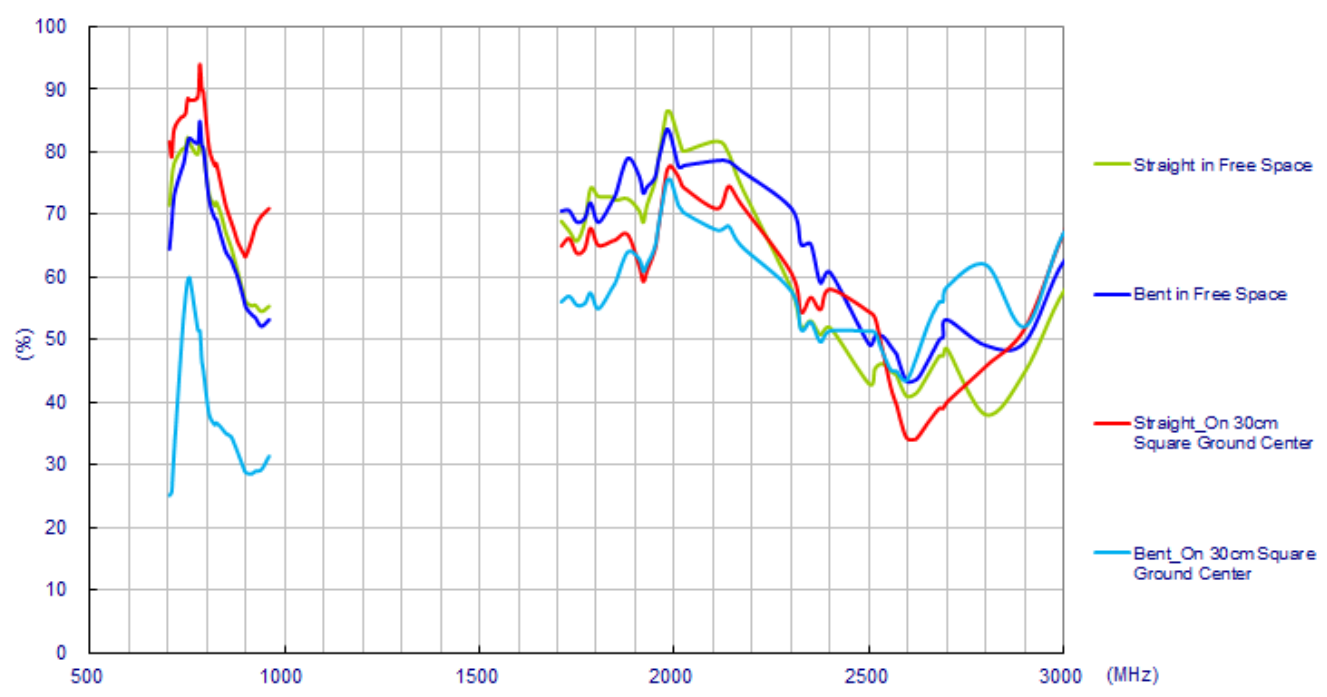

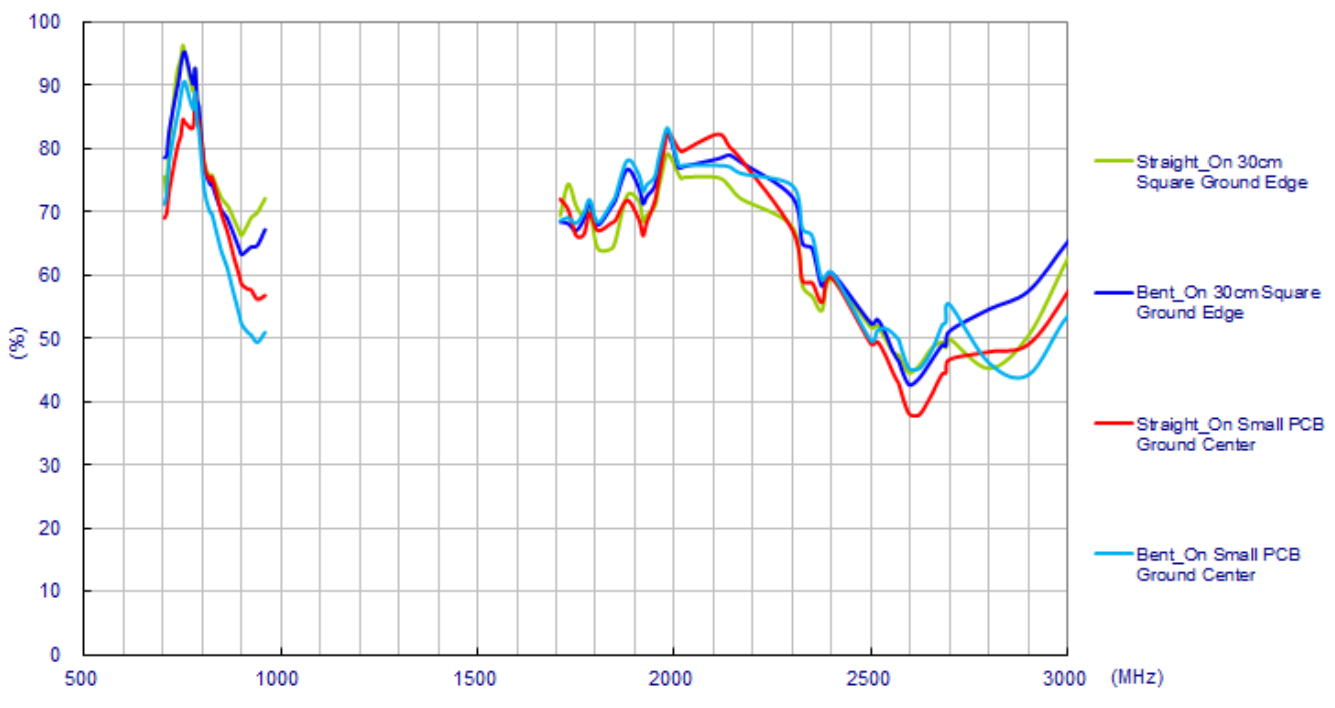

4. Antenna Radiation Patterns

4.1 Antenna setup (Free Space Straight)

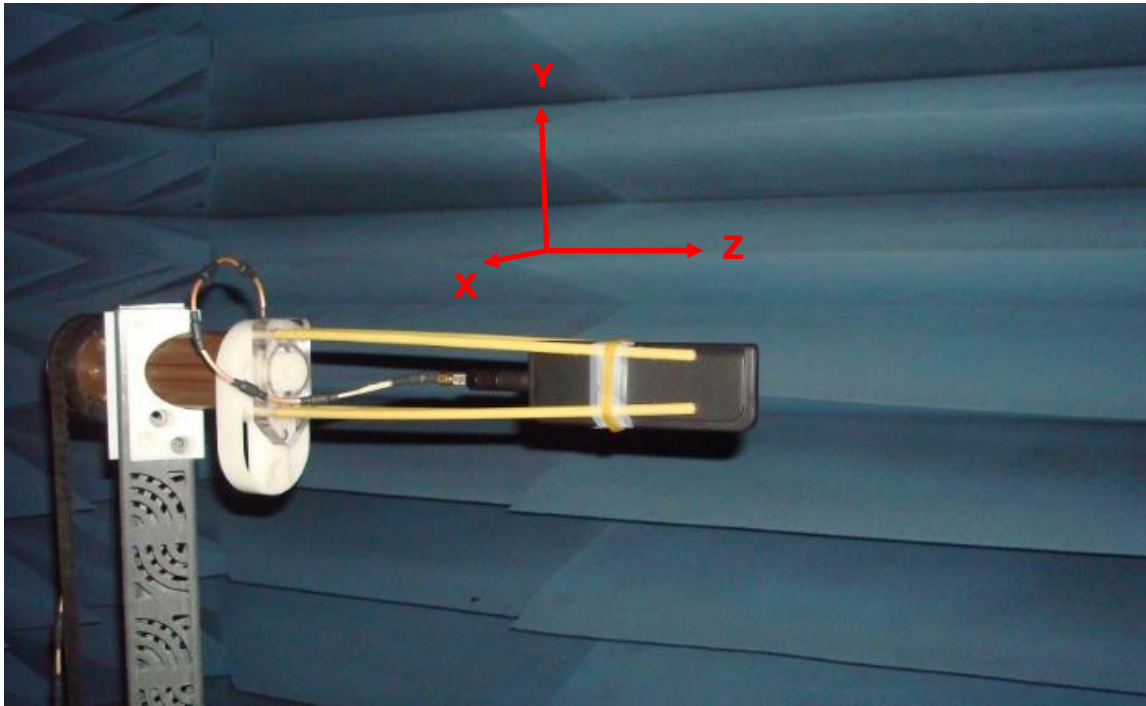

Radiation Patterns

XY Plane

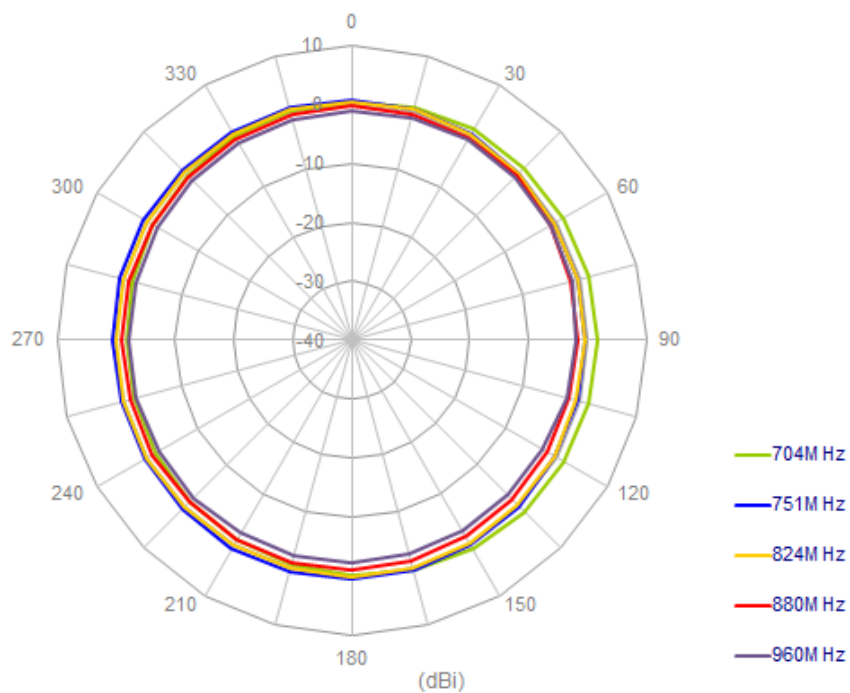

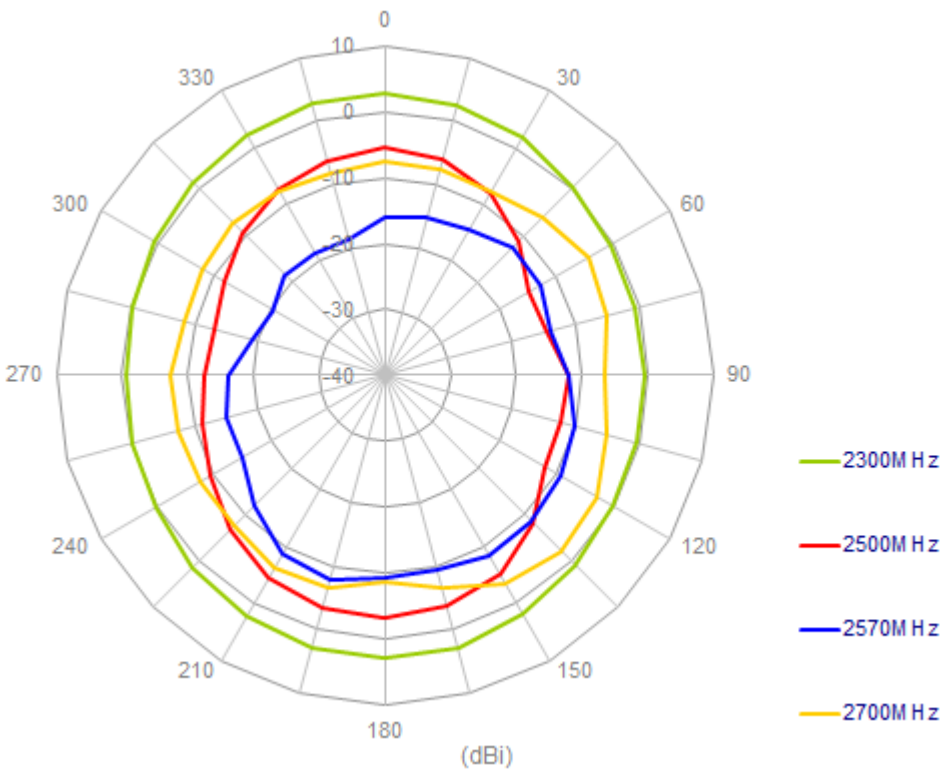
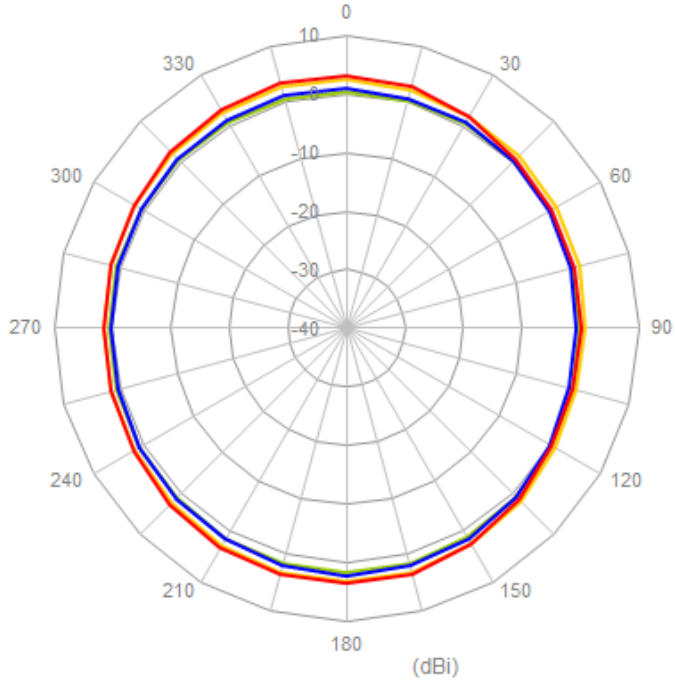

XZ Plane

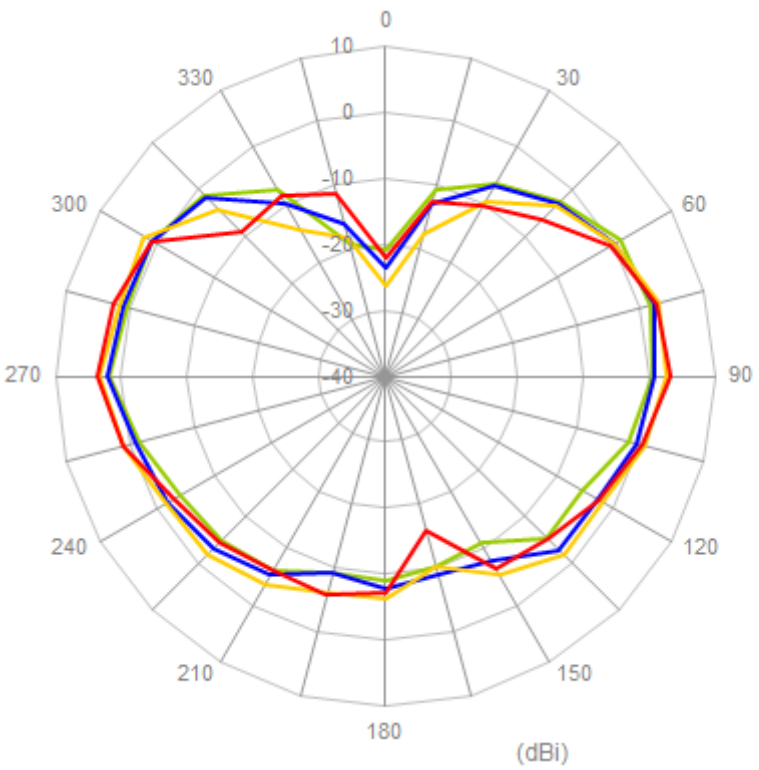
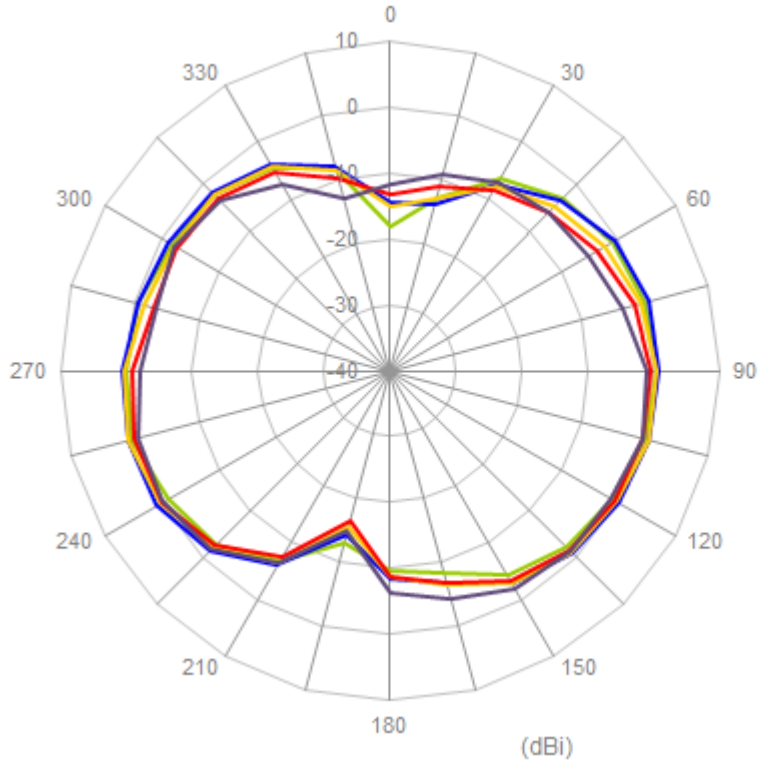

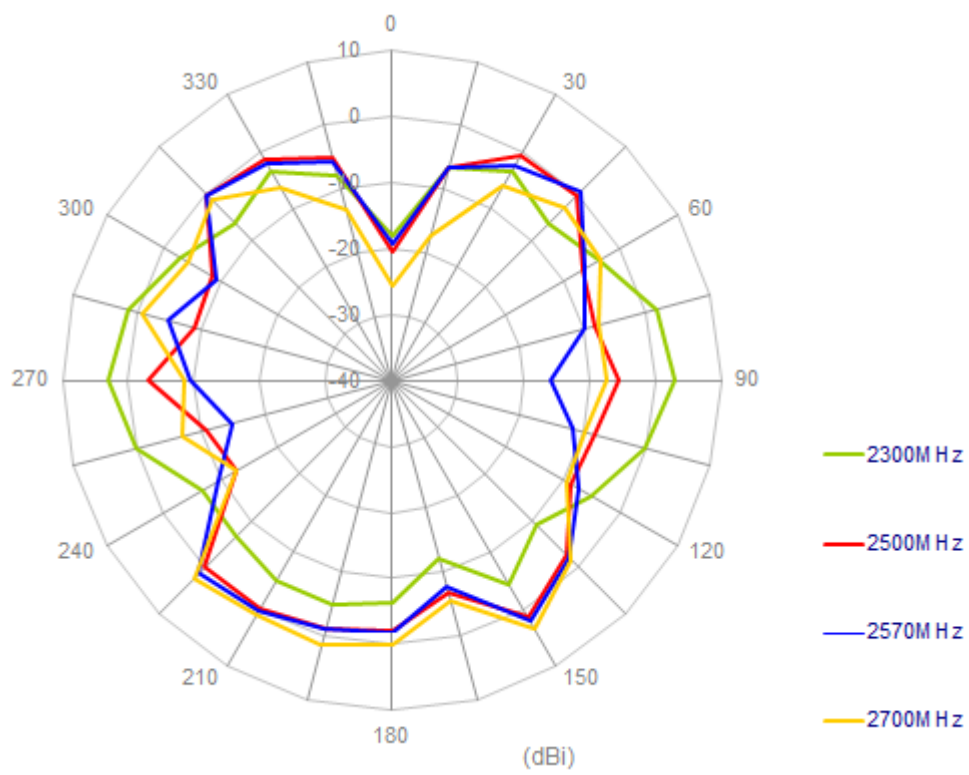

4.2 Antenna setup (Free Space Bent)

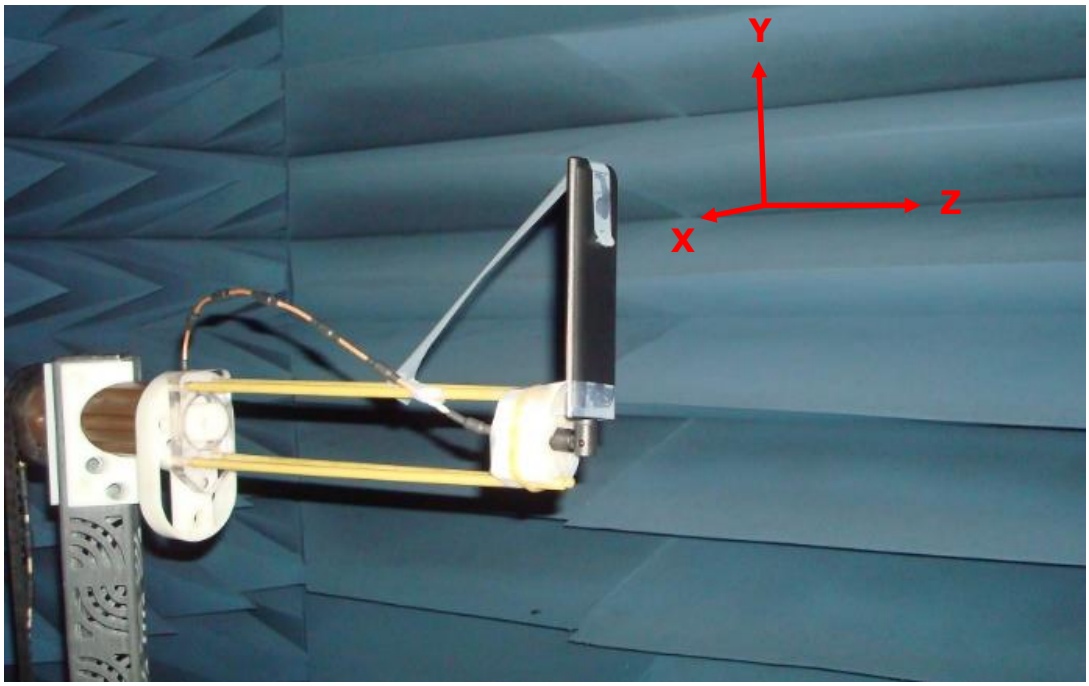

4.2.1 Radiation Patterns

XY Plane

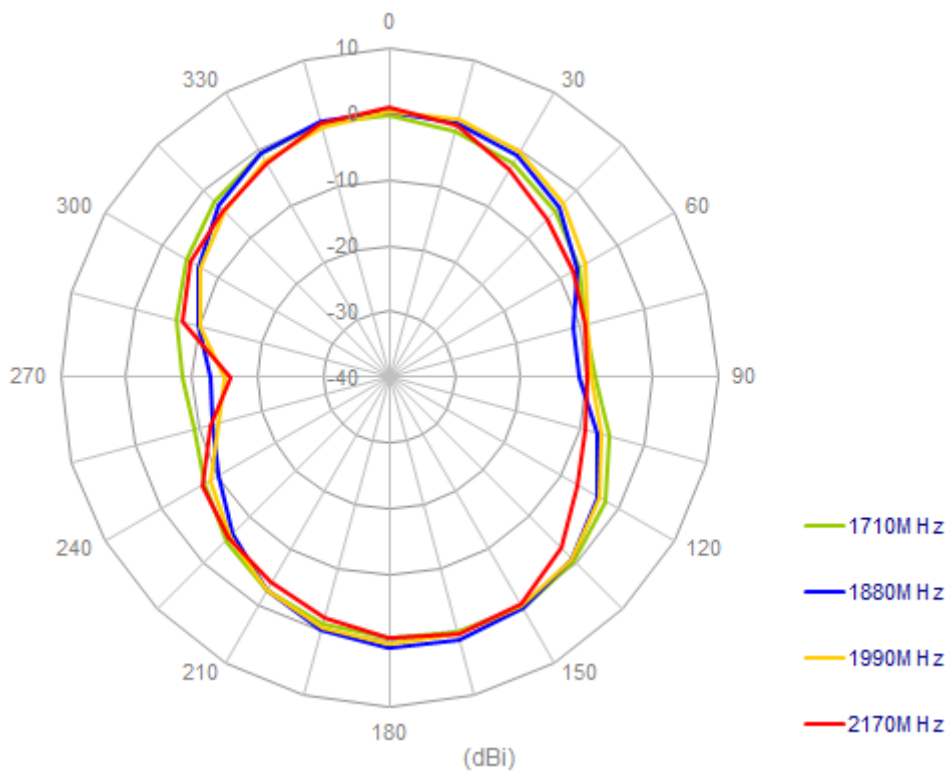
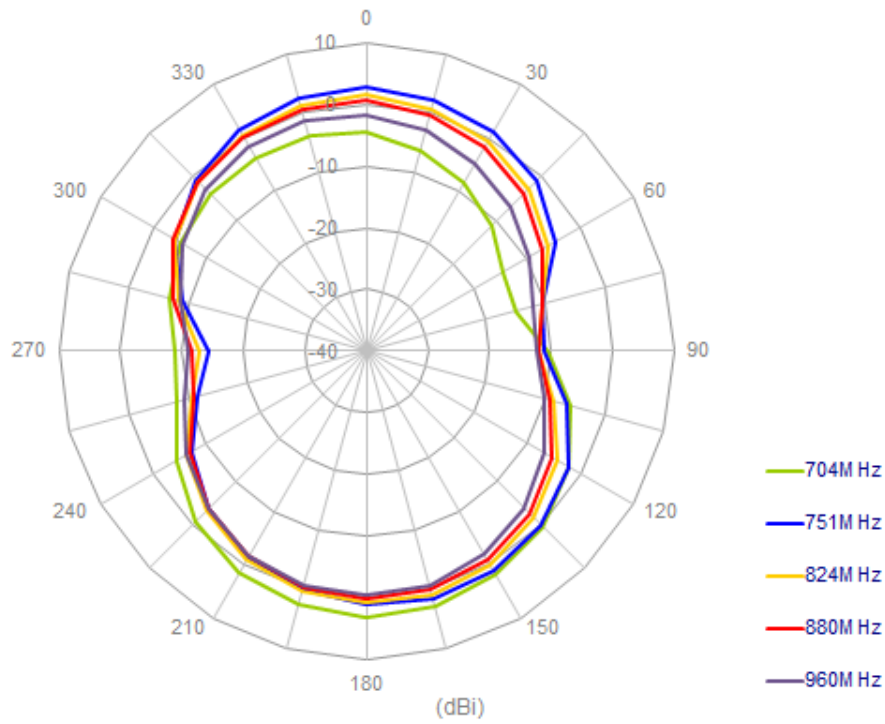

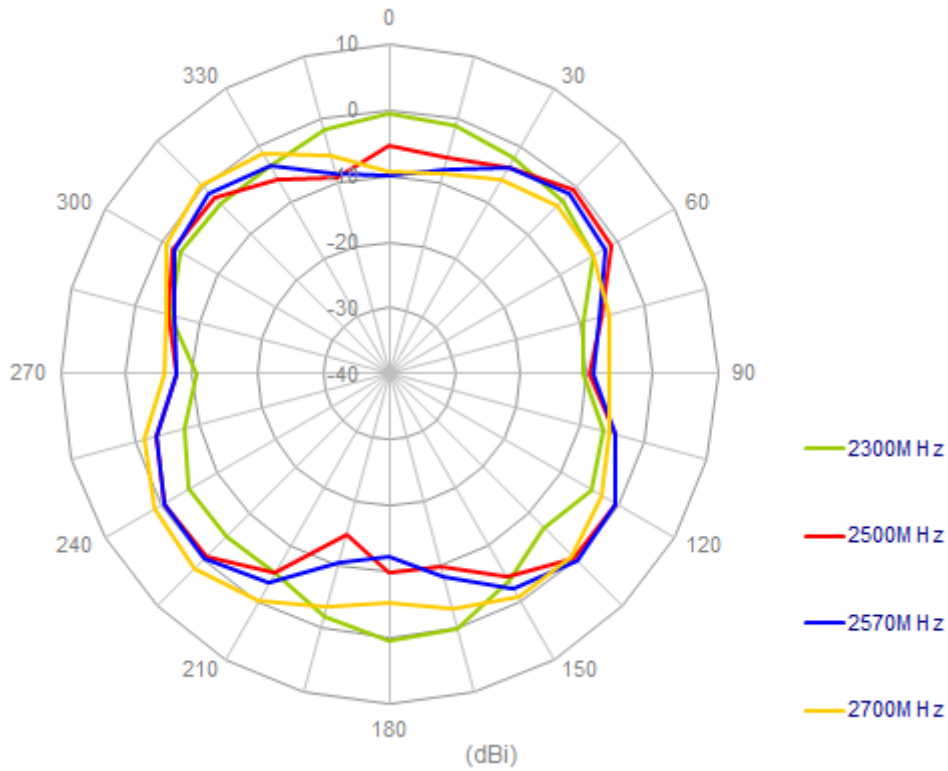

XZ Plane

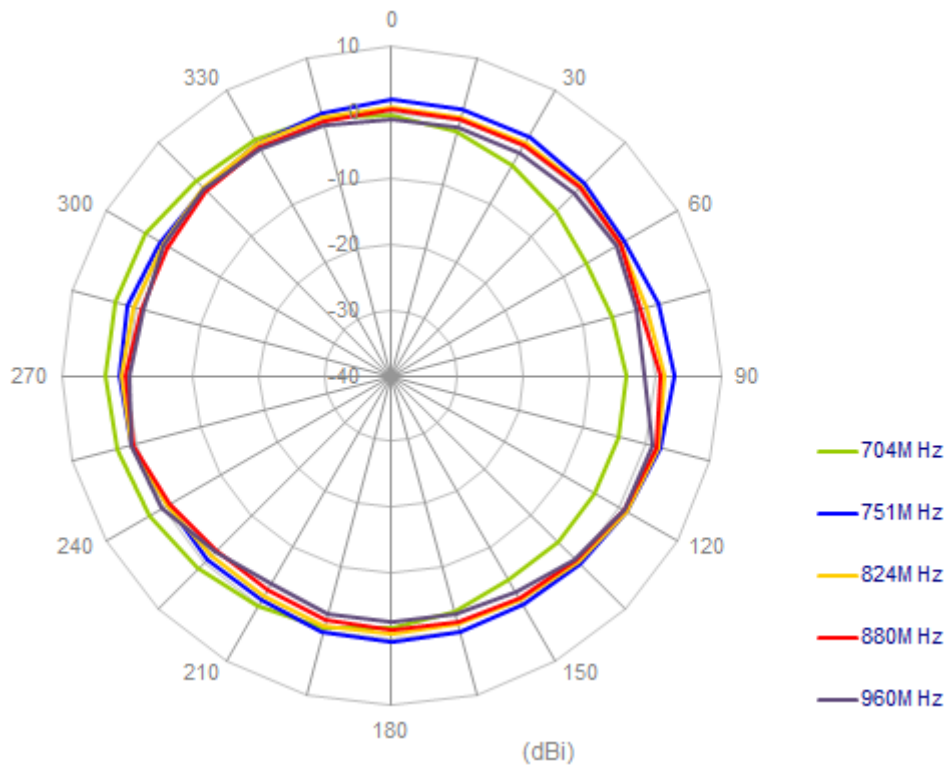

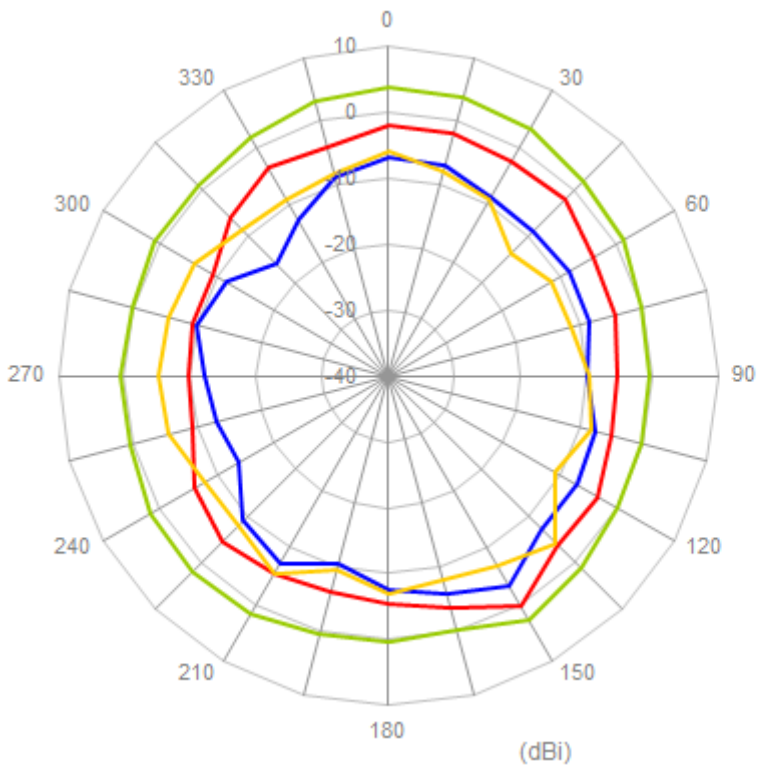
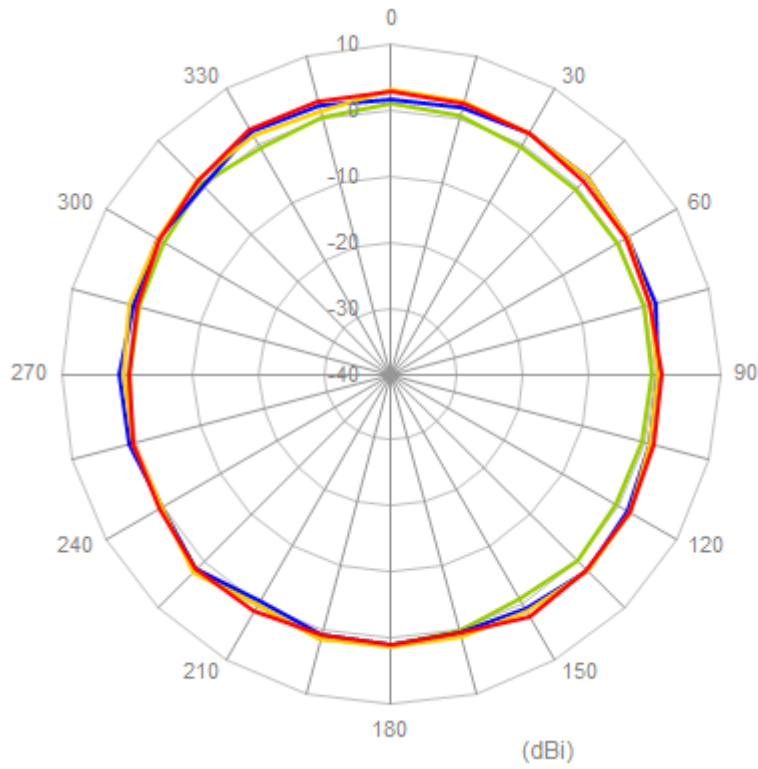

4.3 Antenna setup (On 300x300mm ground center straight)

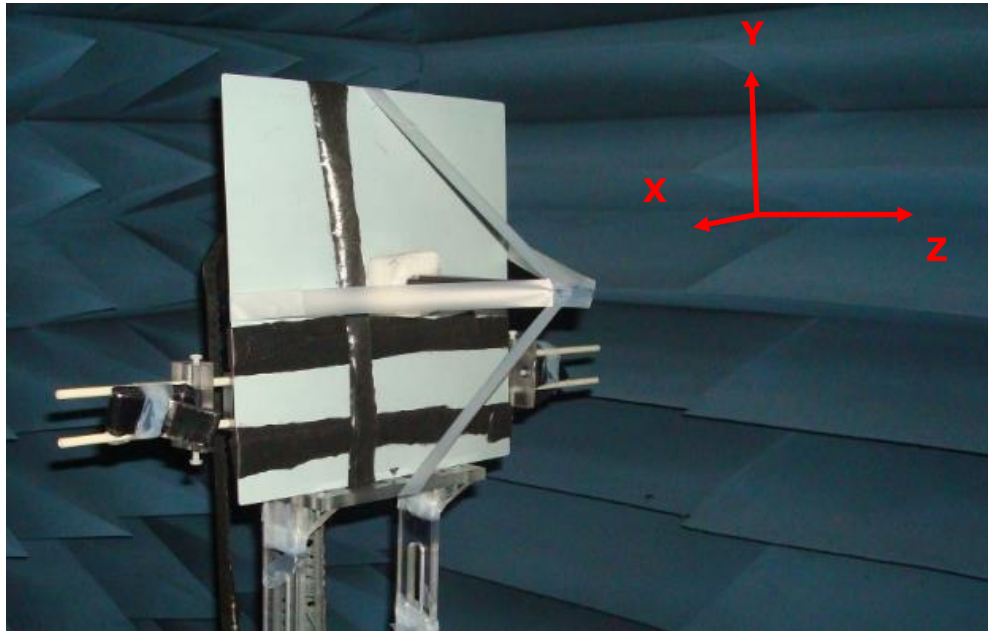

4.3.1 Radiation Patterns

XY Plane

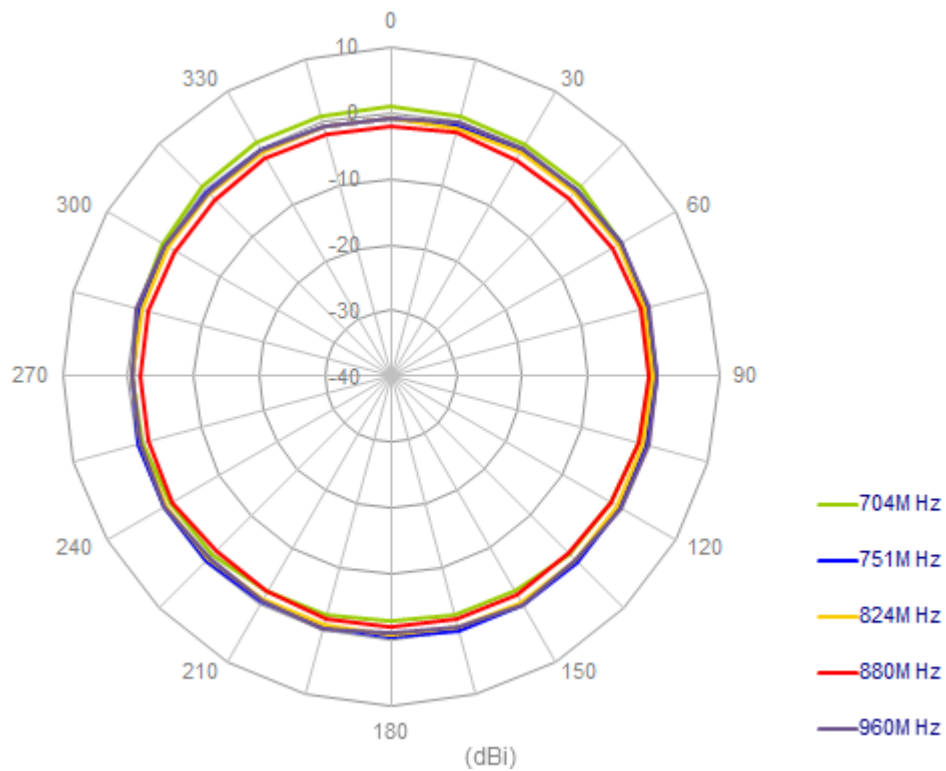

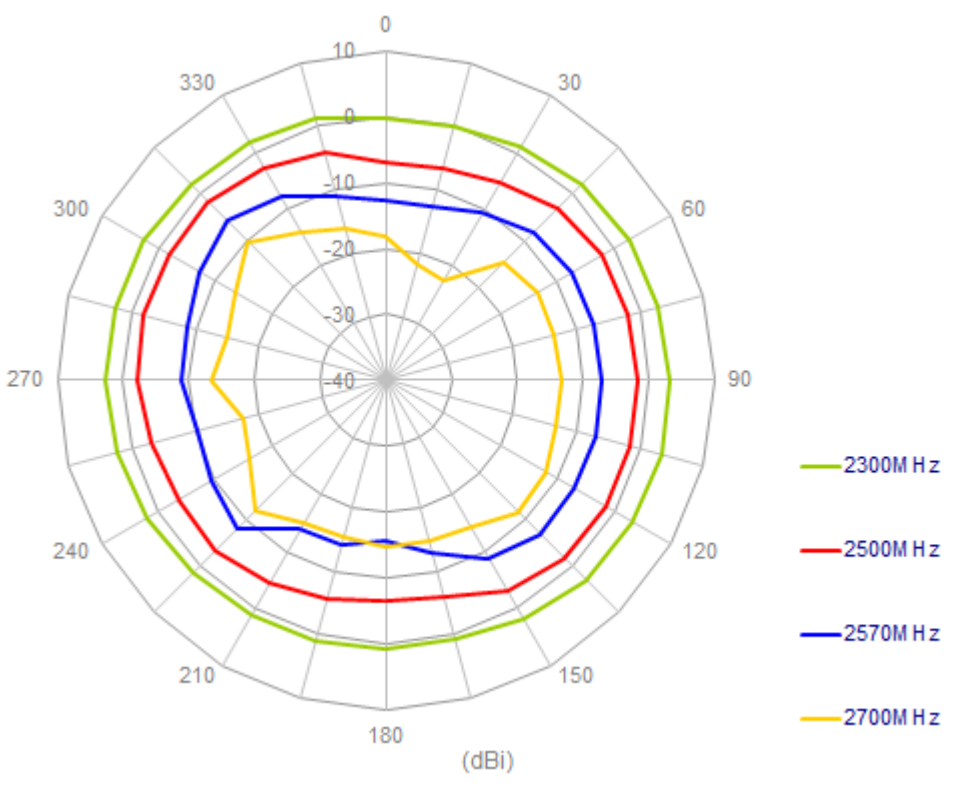
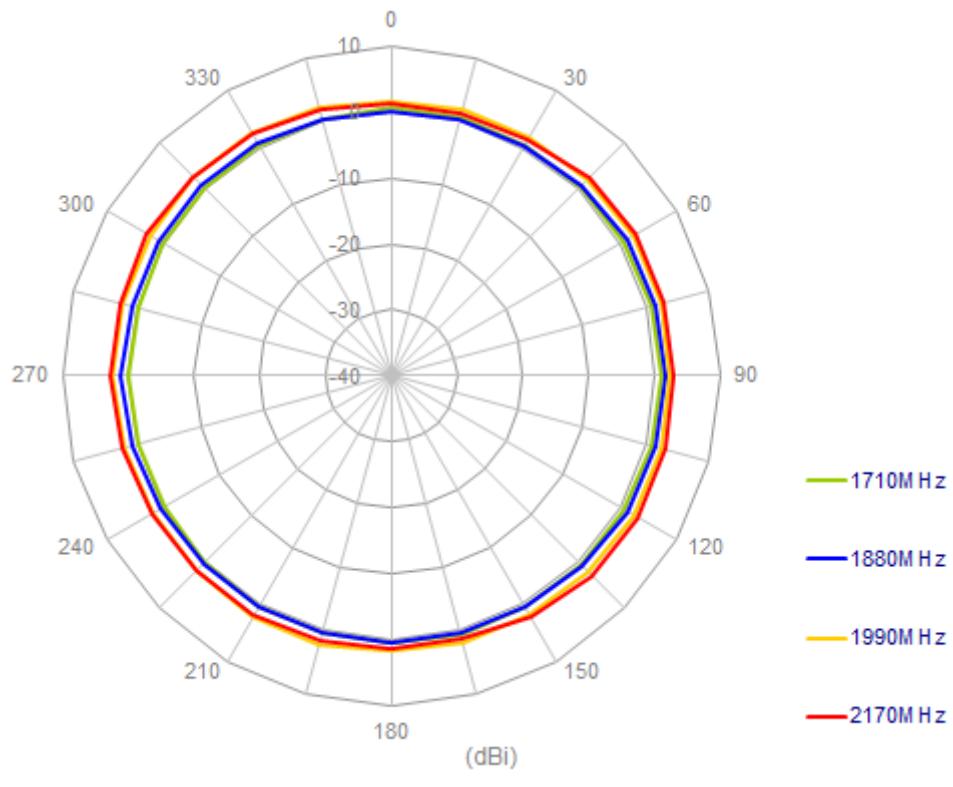

XZ Plane

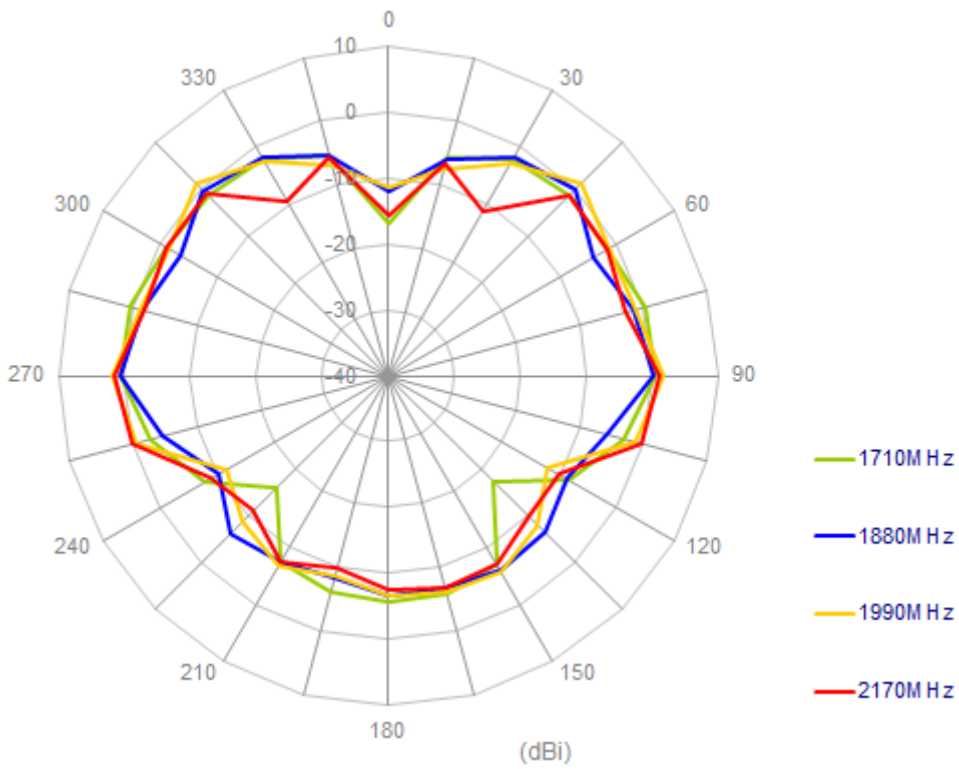
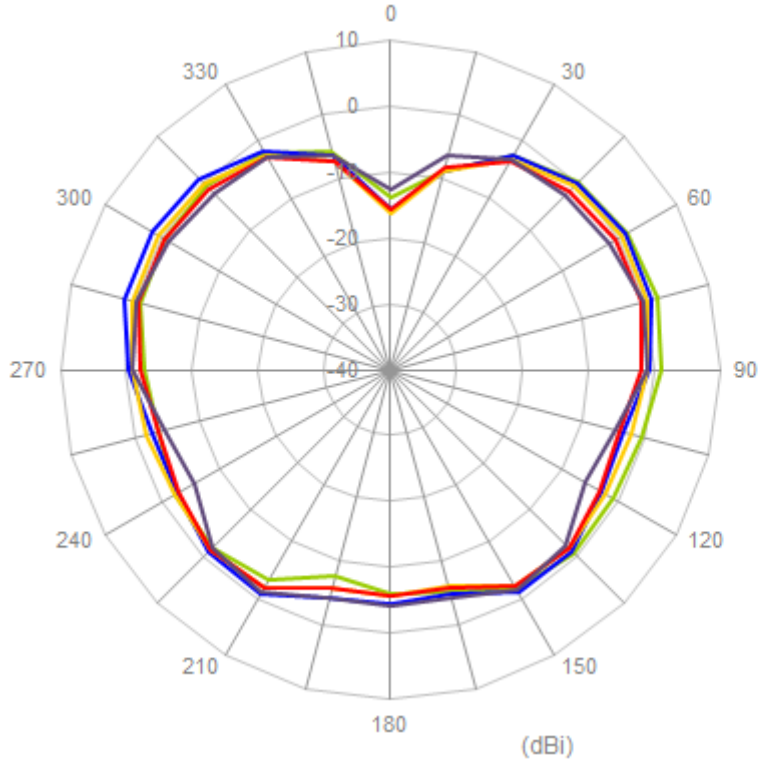

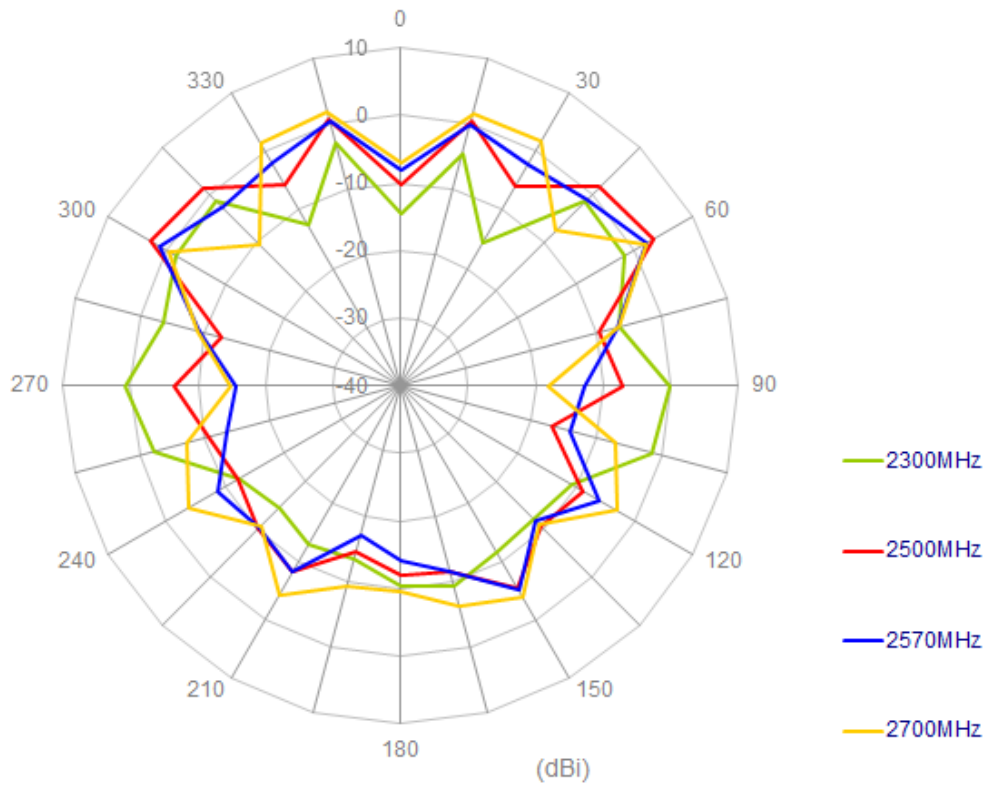

4.4 Antenna setup (On 300x300mm ground center bent)

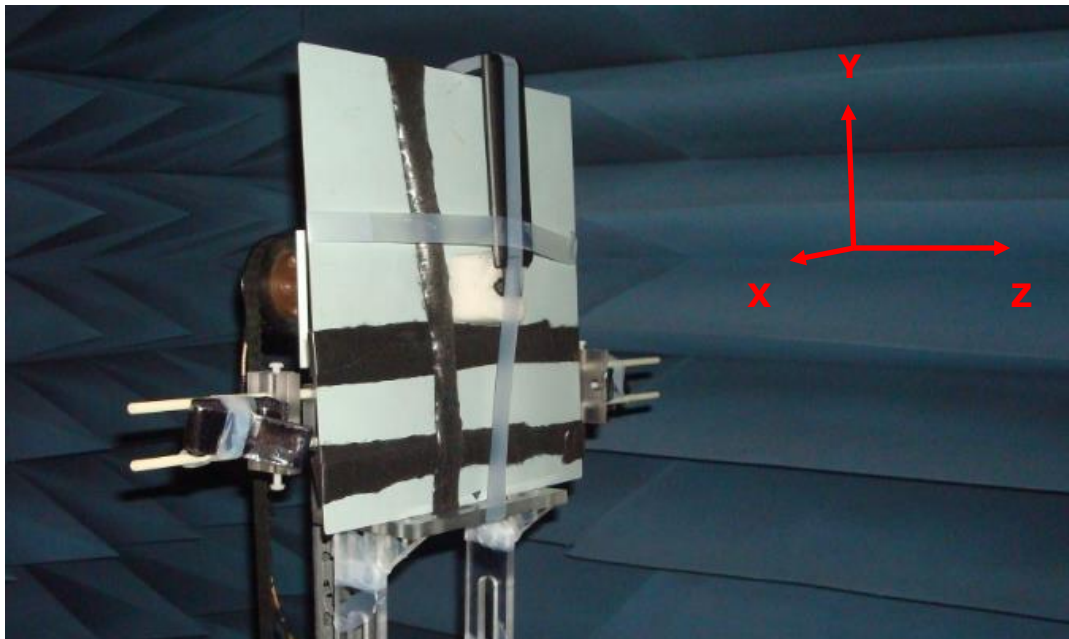

4.4.1 Radiation Patterns

XY Plane

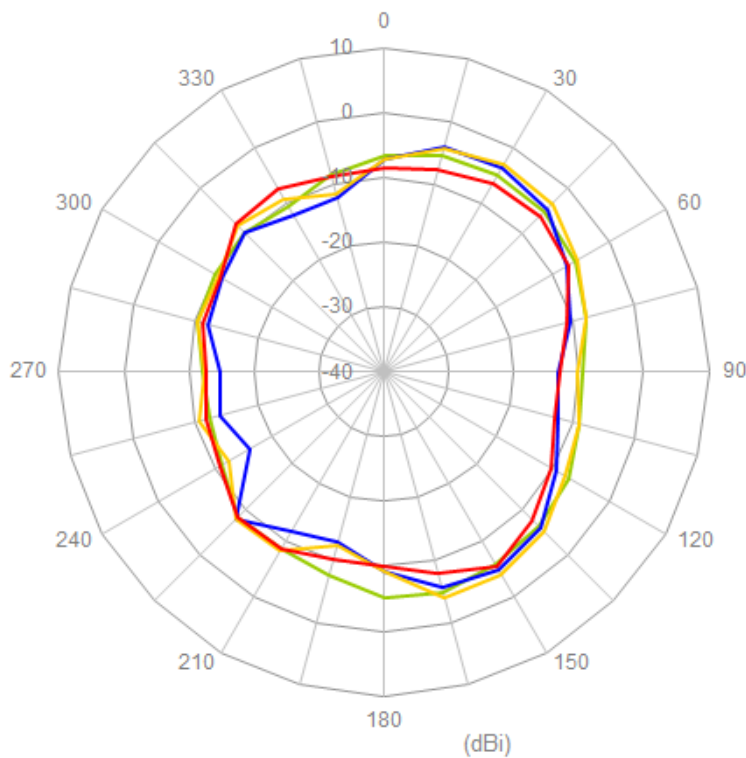
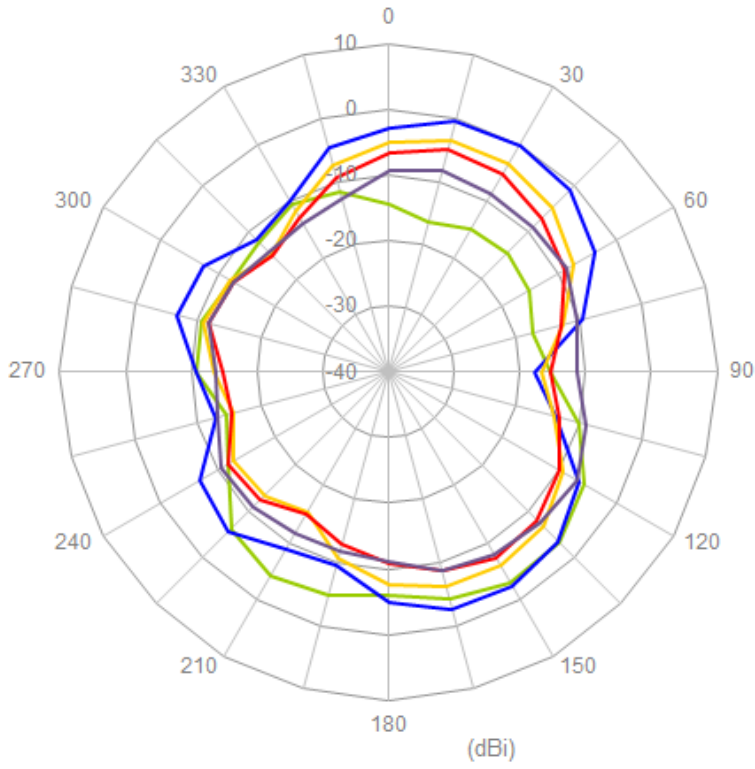

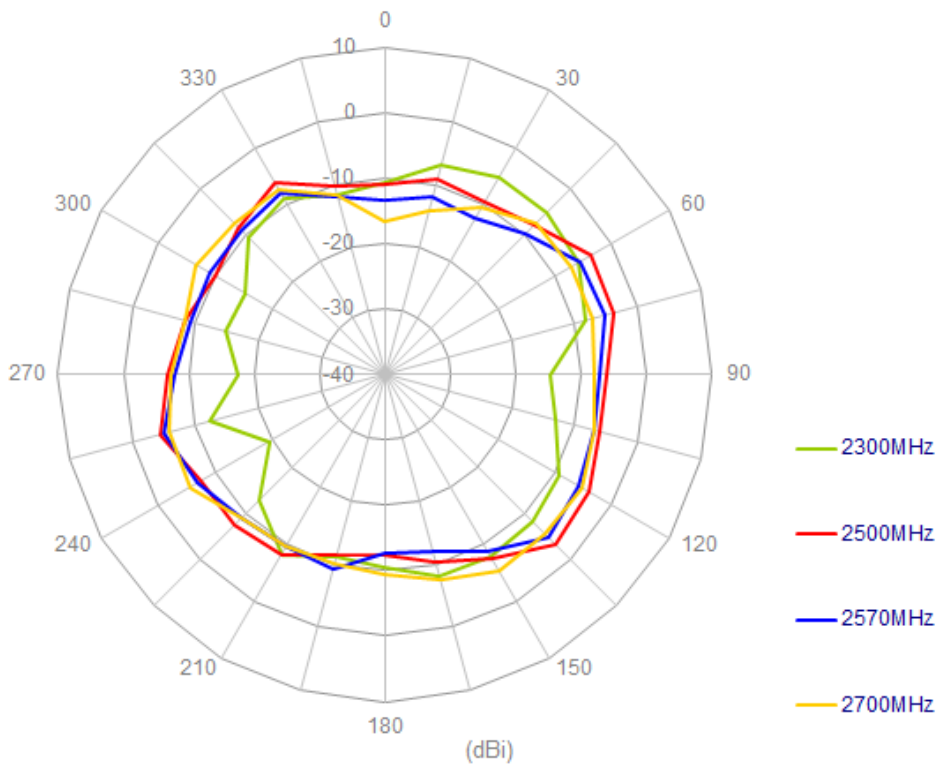

XZ Plane

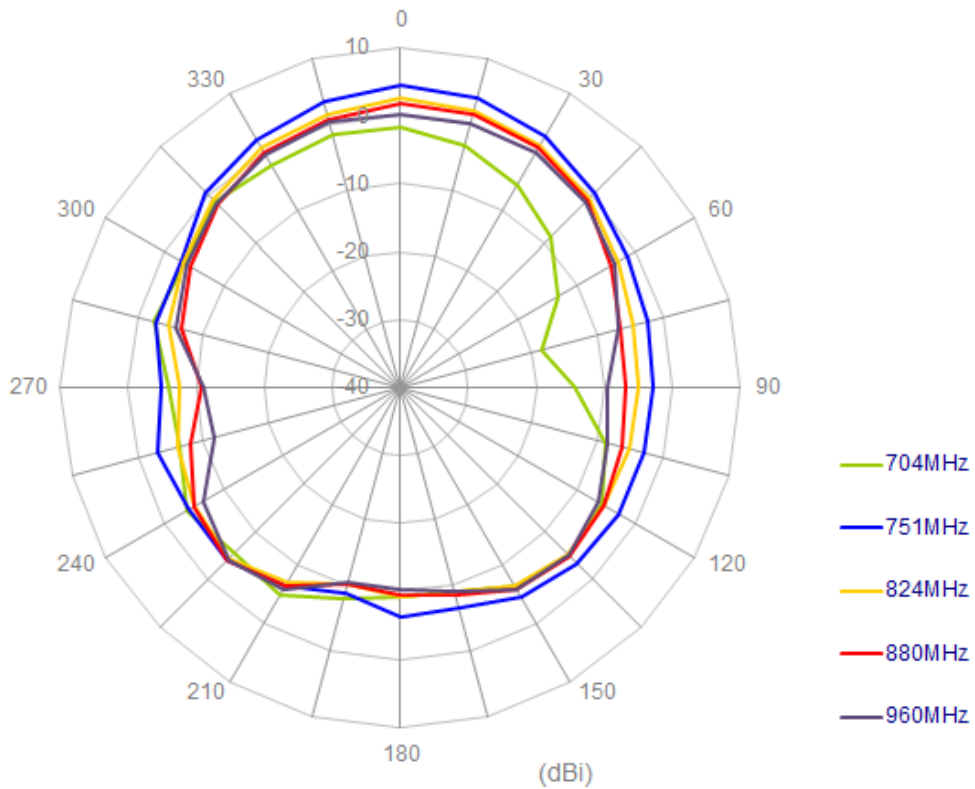

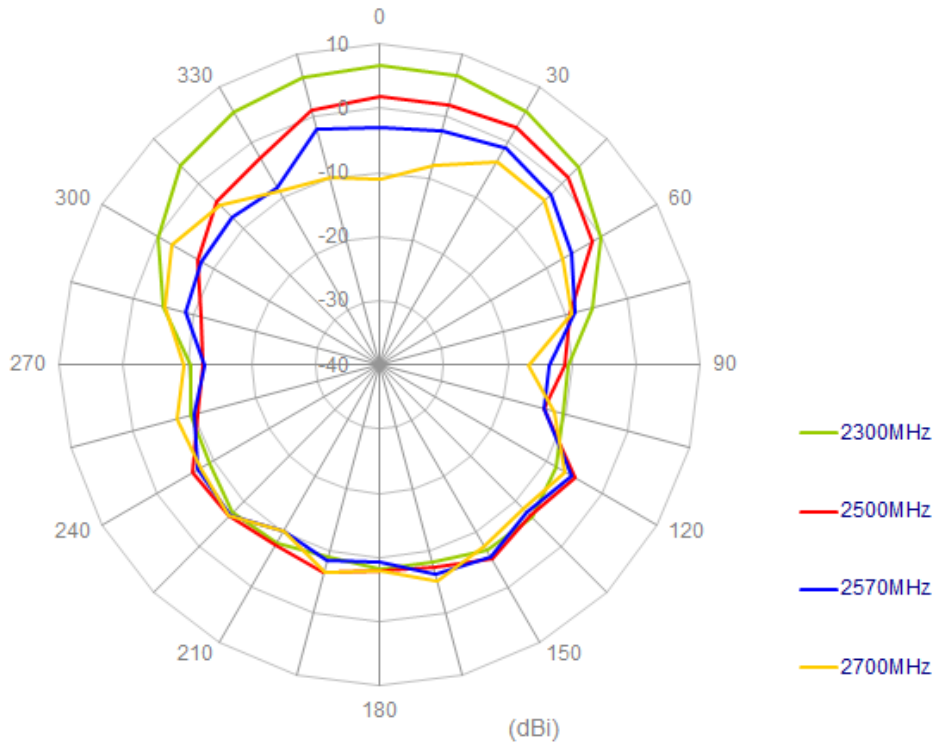
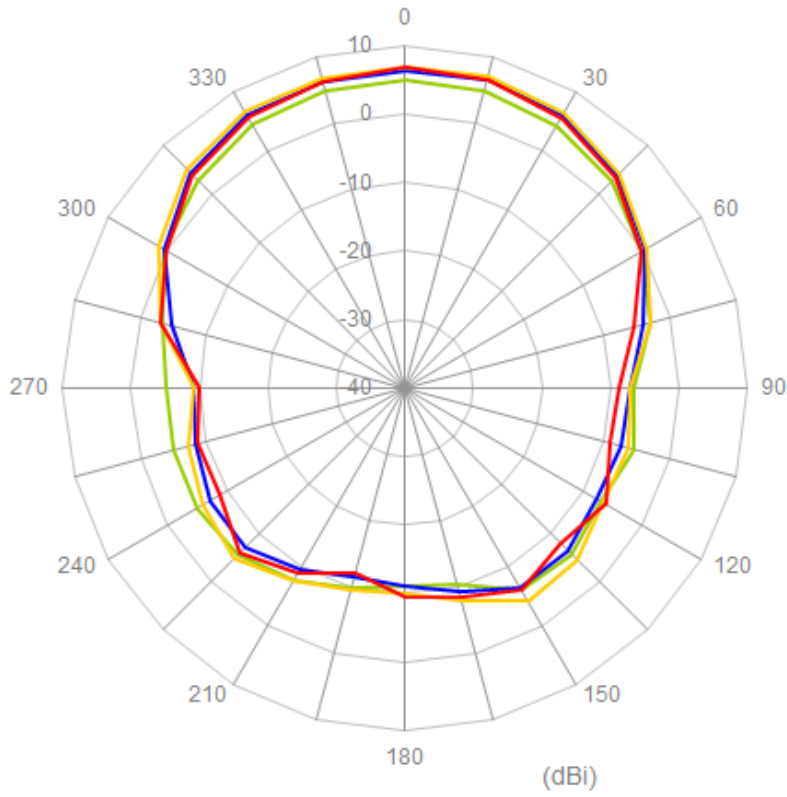

4.5 Antenna setup (On 300x300mm ground edge straight)

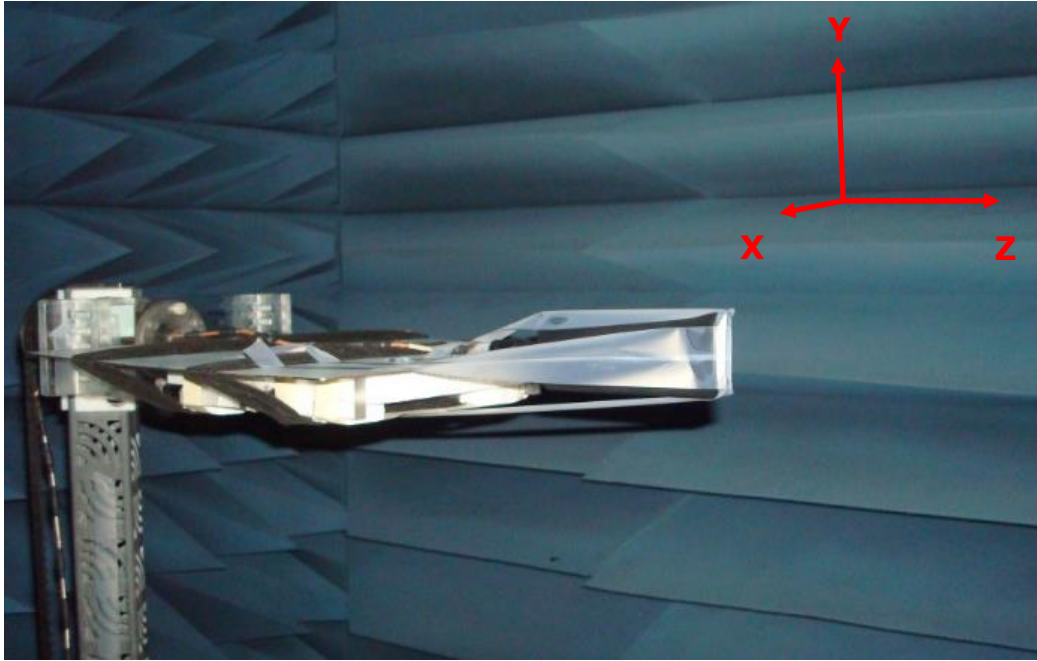

4.5.1 Radiation Patterns

XY Plane

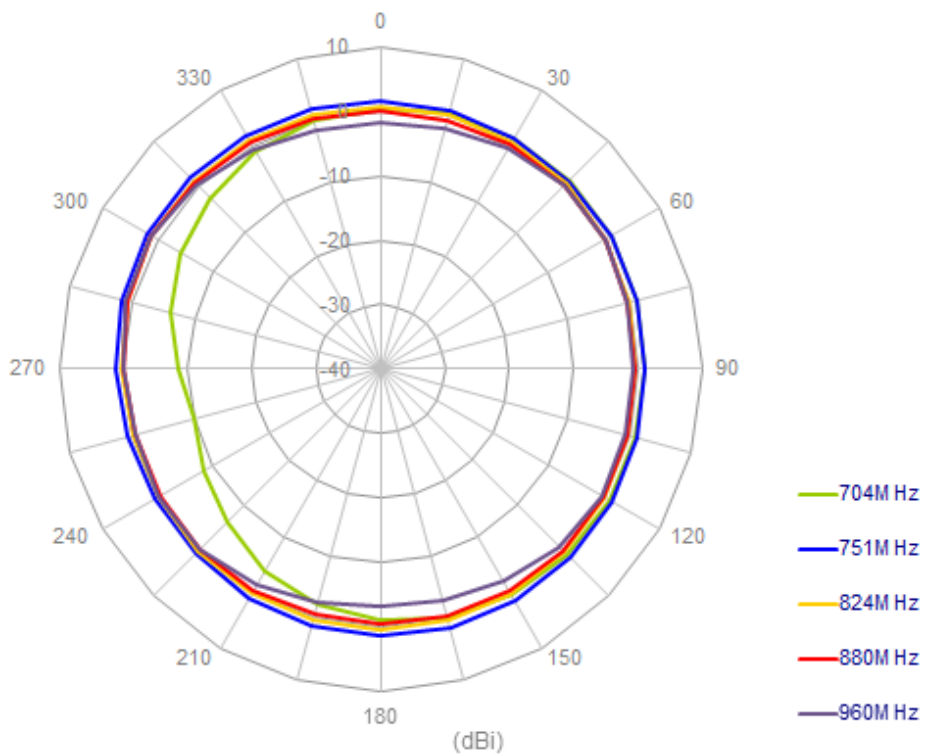

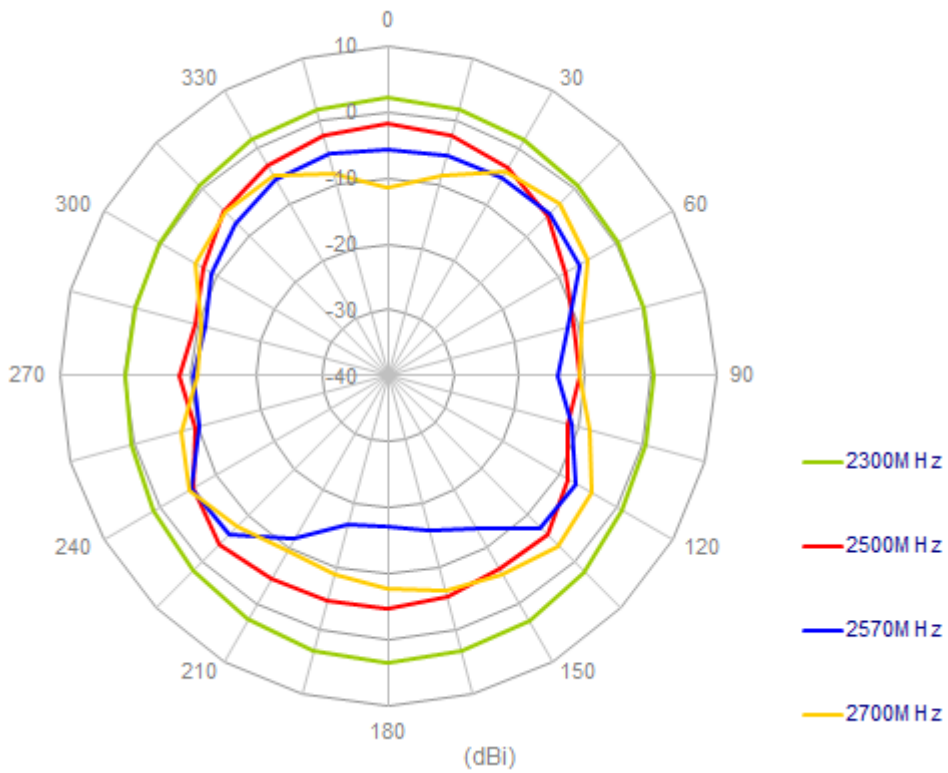
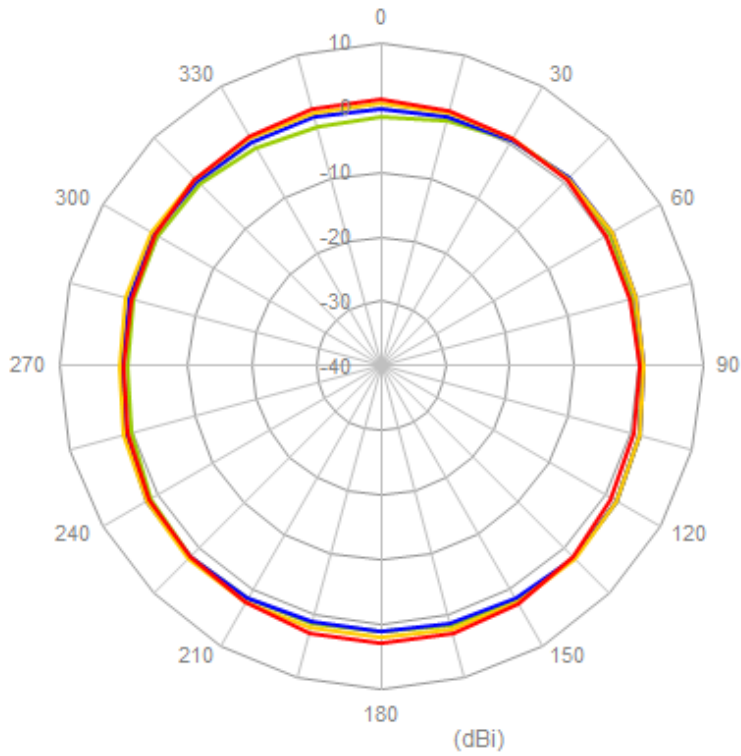

XZ Plane

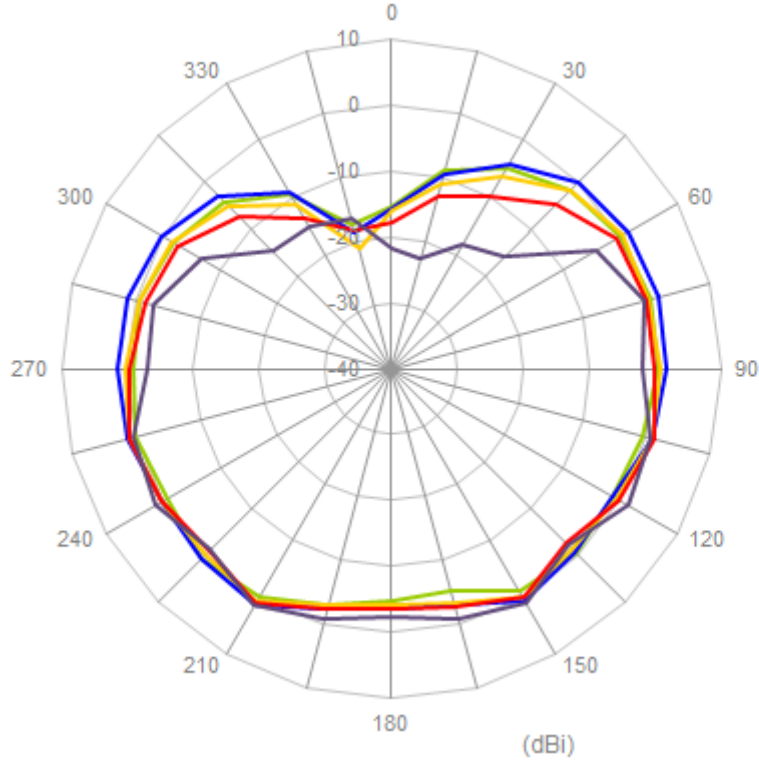

- 704M Hz
- 751M Hz
- 824M Hz
- 880M Hz
- 960M Hz

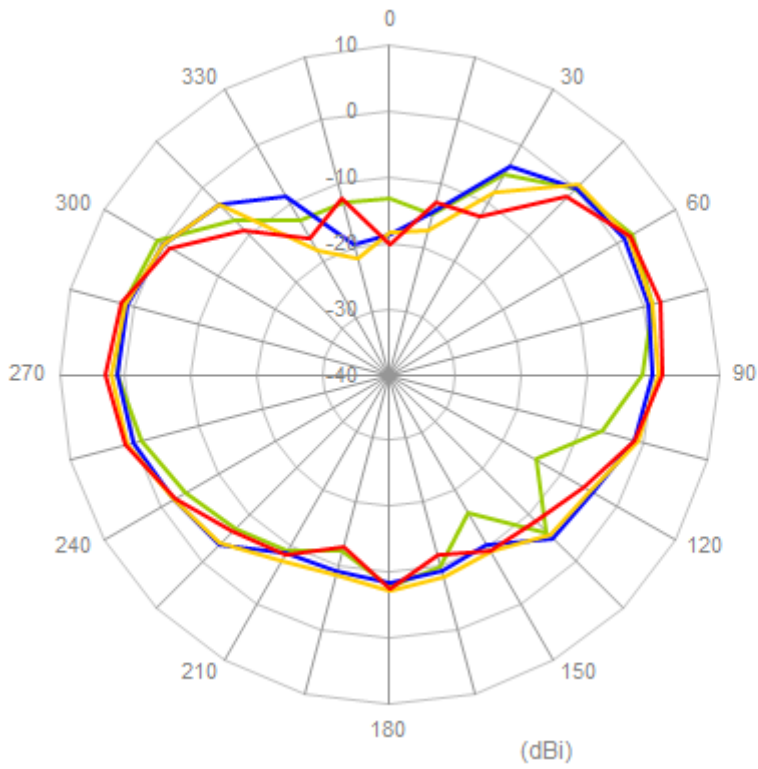

- 1710M Hz
- 1880M Hz
- 1990M Hz
- 2170M Hz

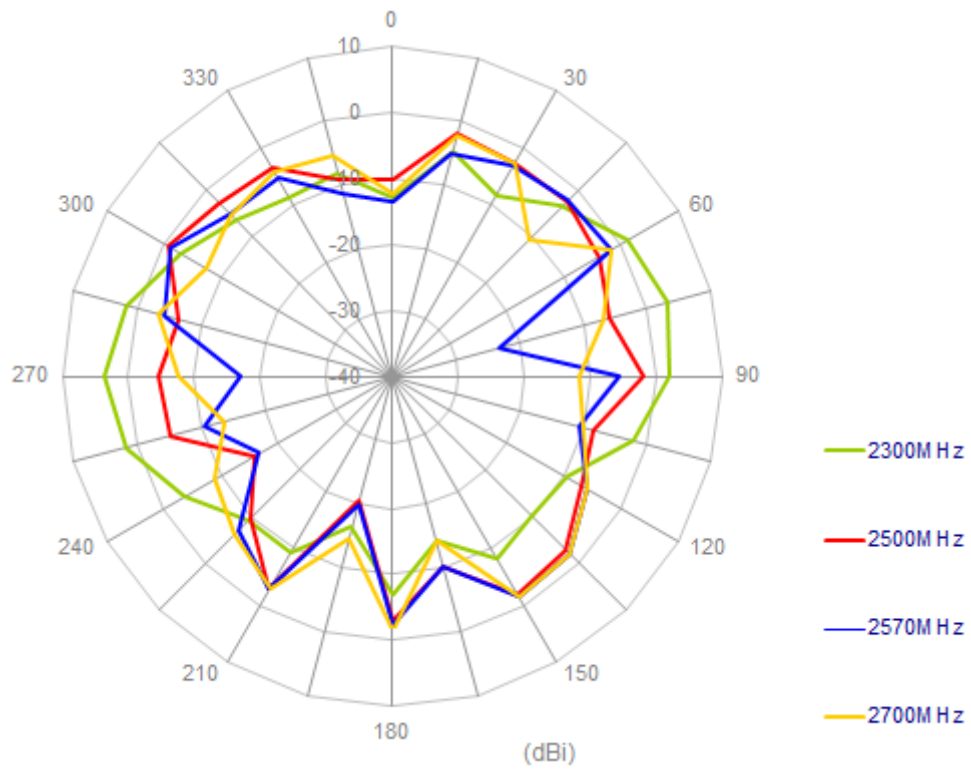

4.6 Antenna setup (On 300x300mm ground edge bent)



4.6.1 Radiation Patterns

XY Plane

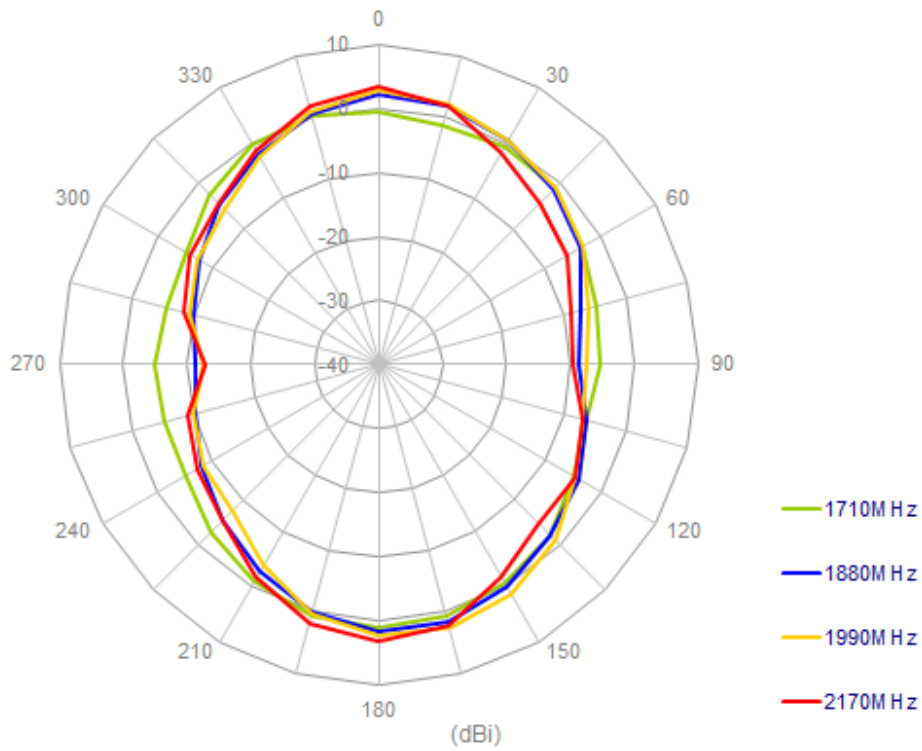
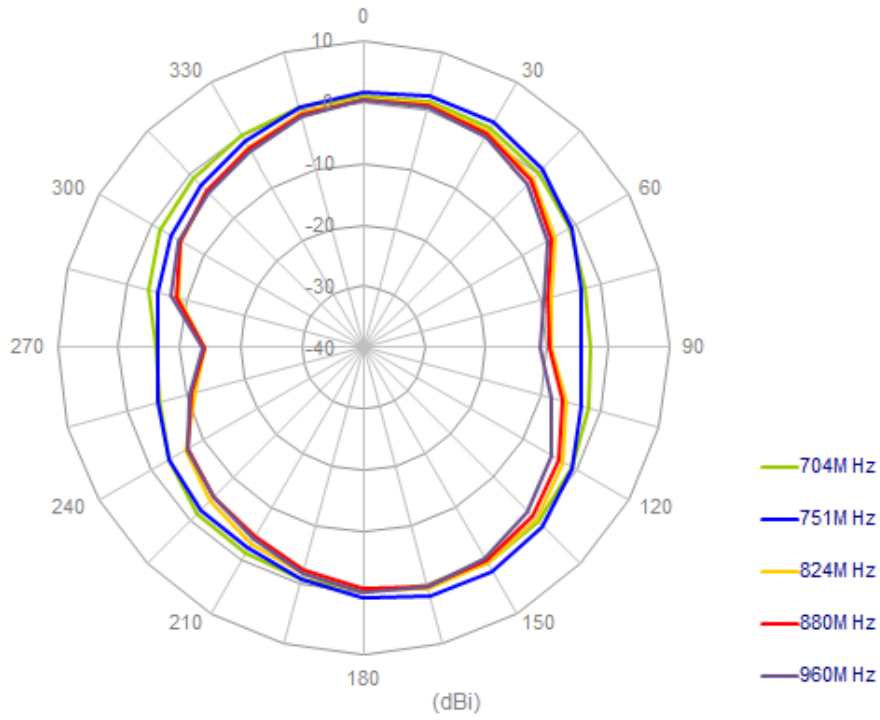

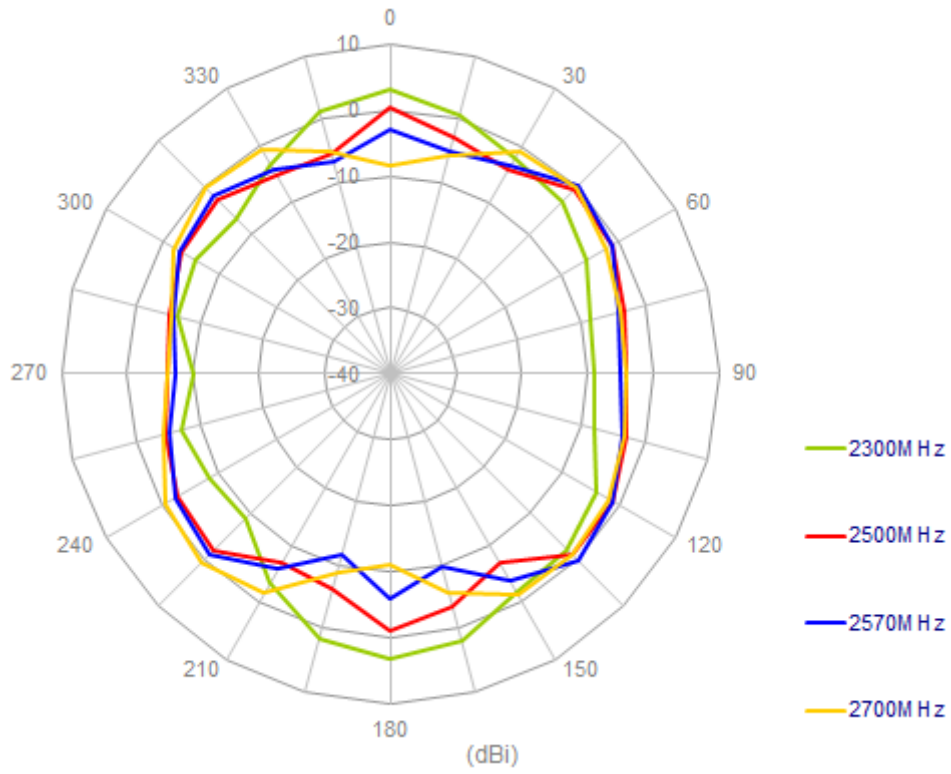

XZ Plane

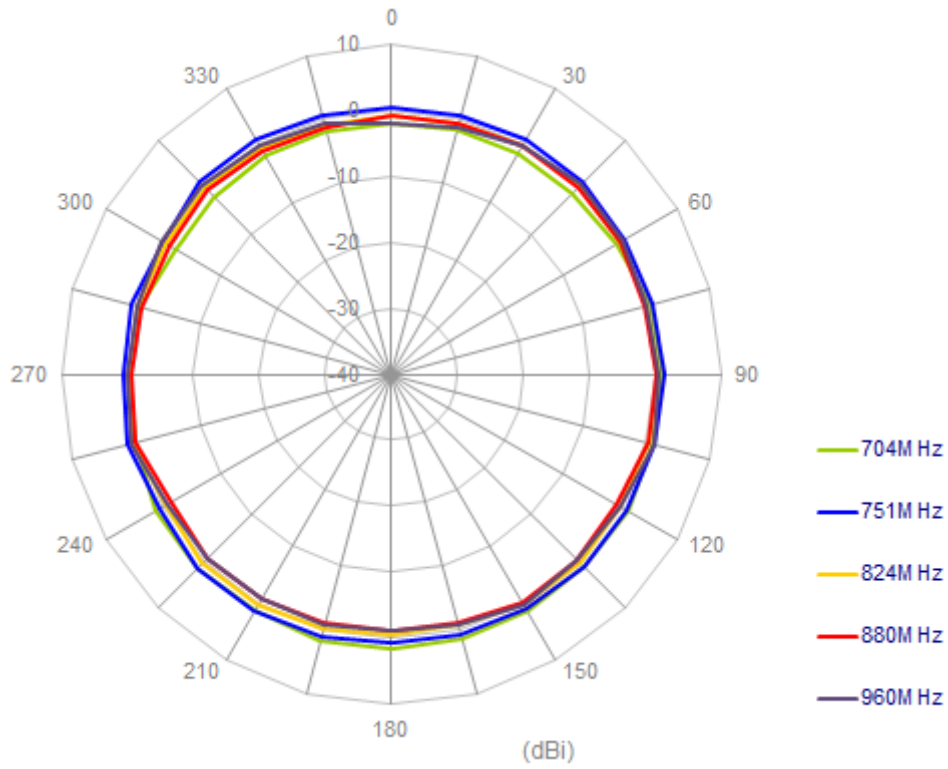

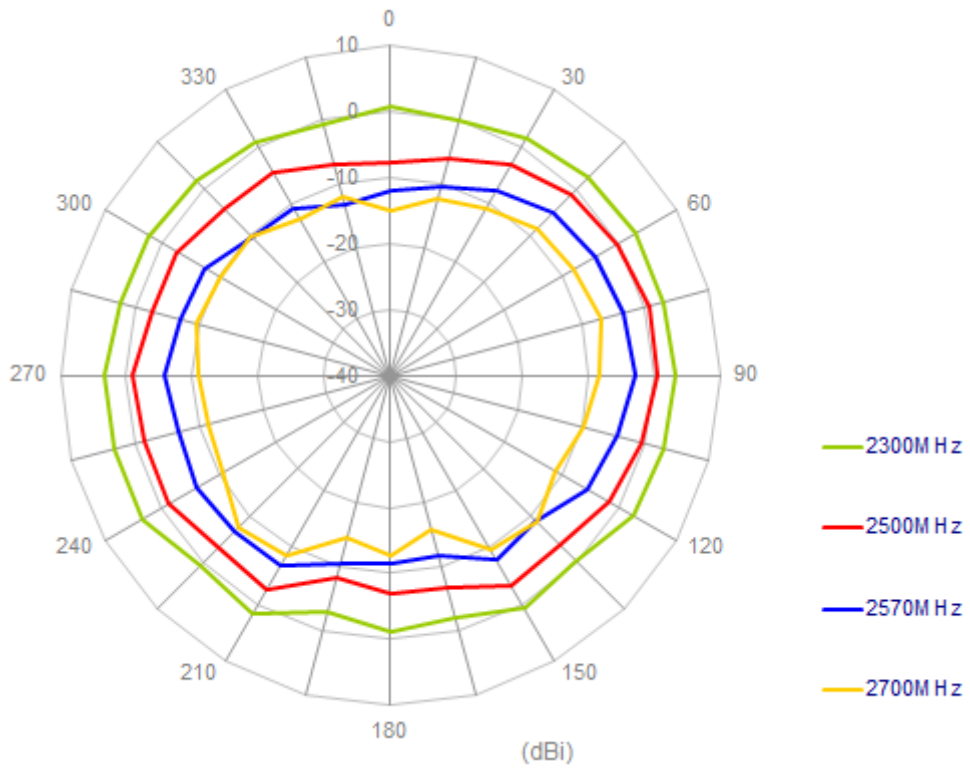
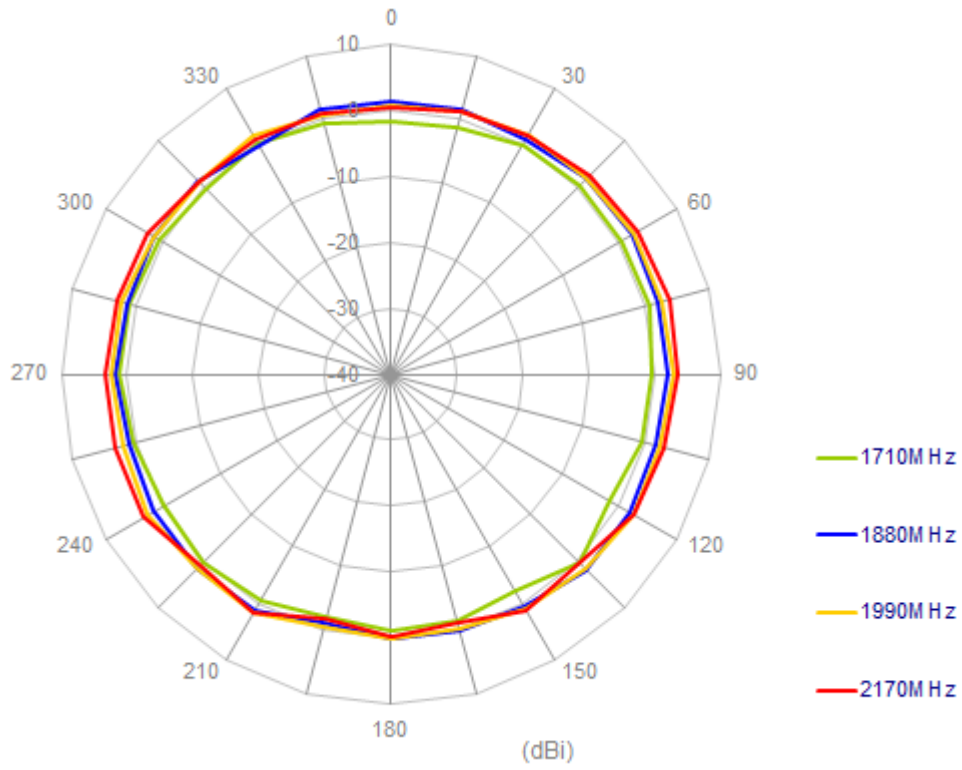

4.7 Antenna setup (On Ground edge straight)

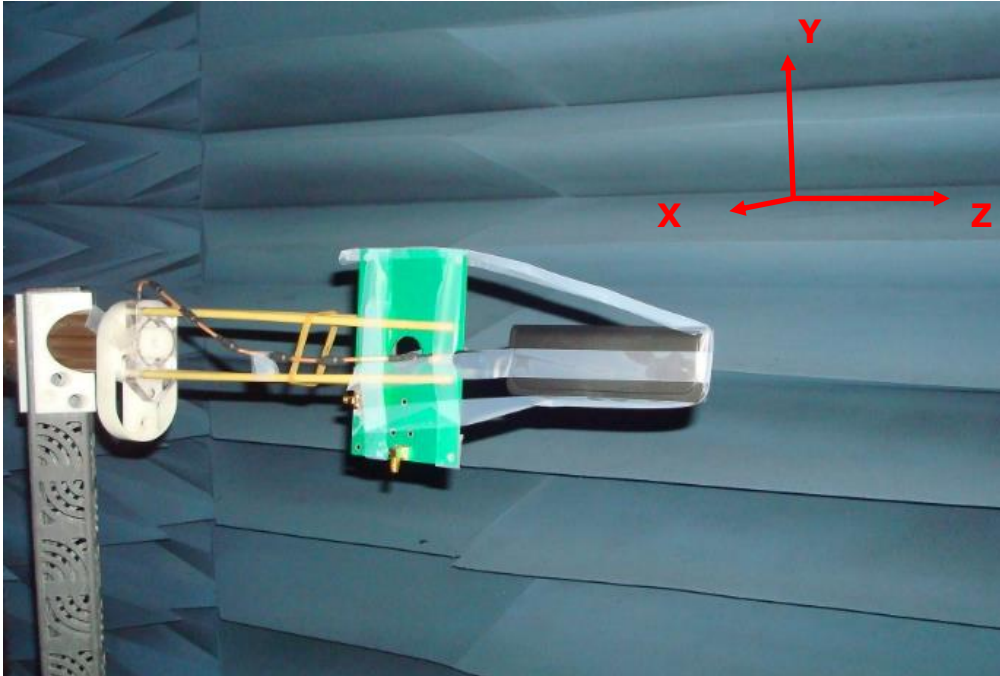

4.7.1 Radiation Patterns XY Plane

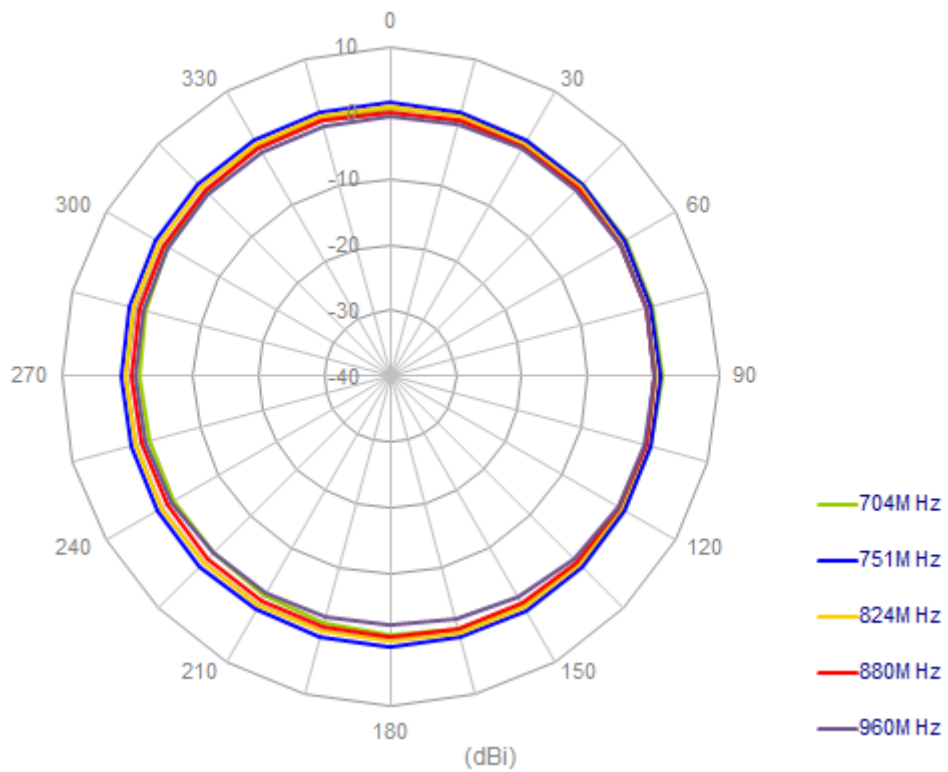

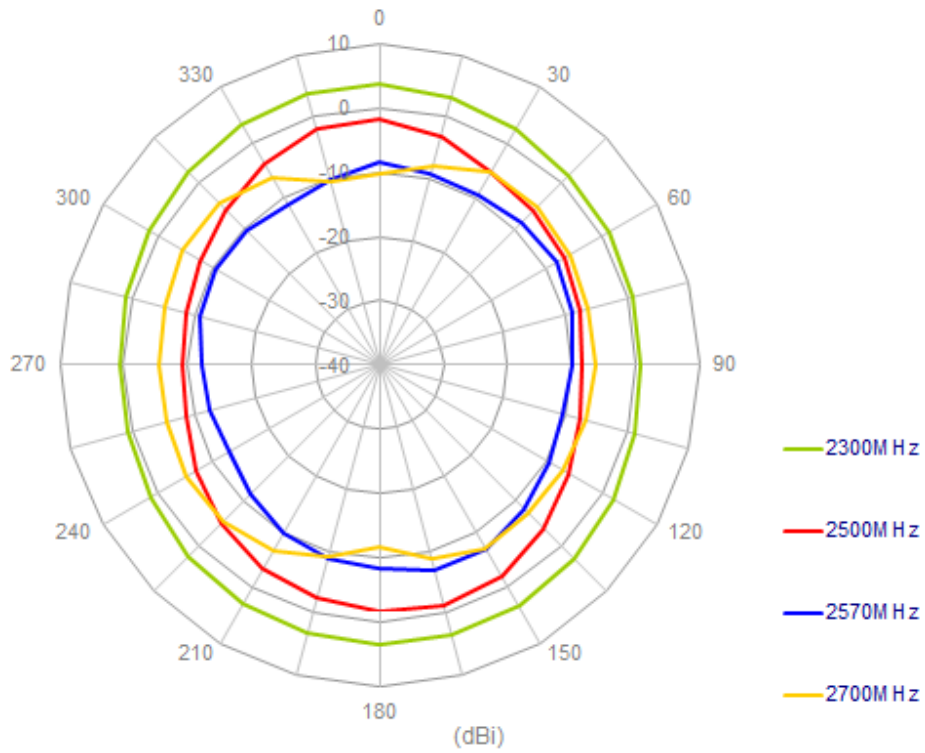
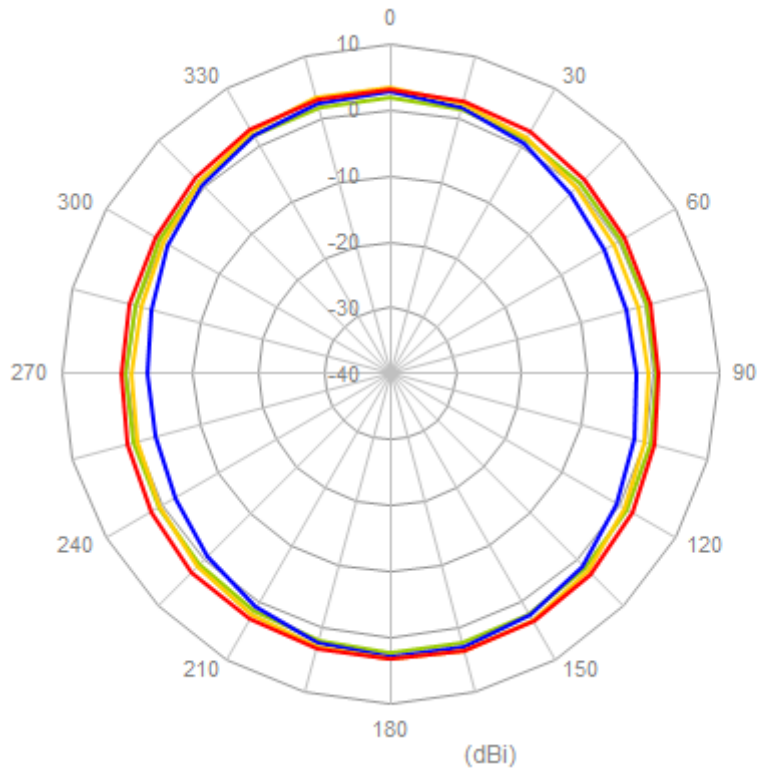

XZ Plane

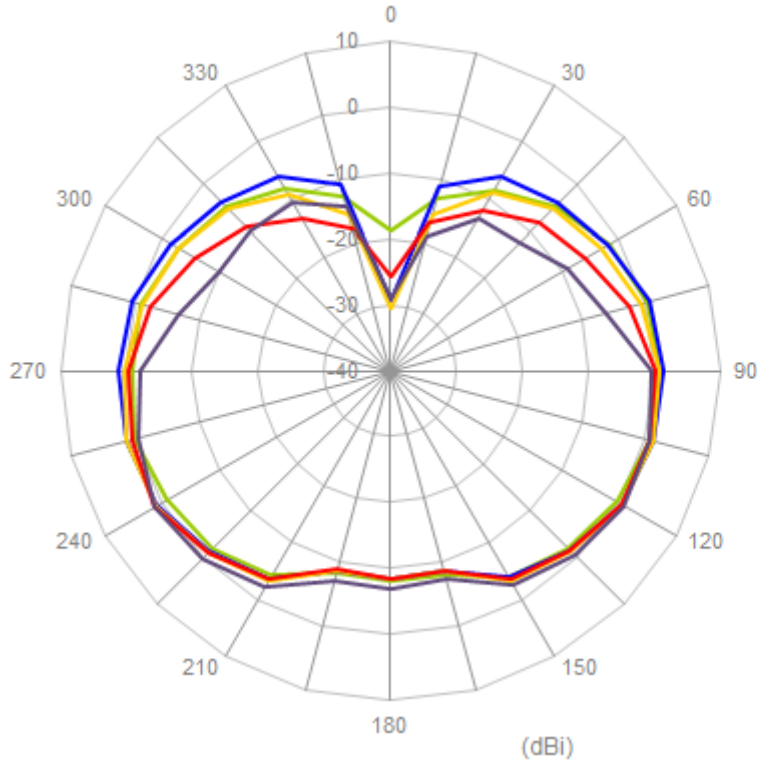

- 704M Hz
- 751M Hz
- 824M Hz
- 880M Hz
- 960M Hz

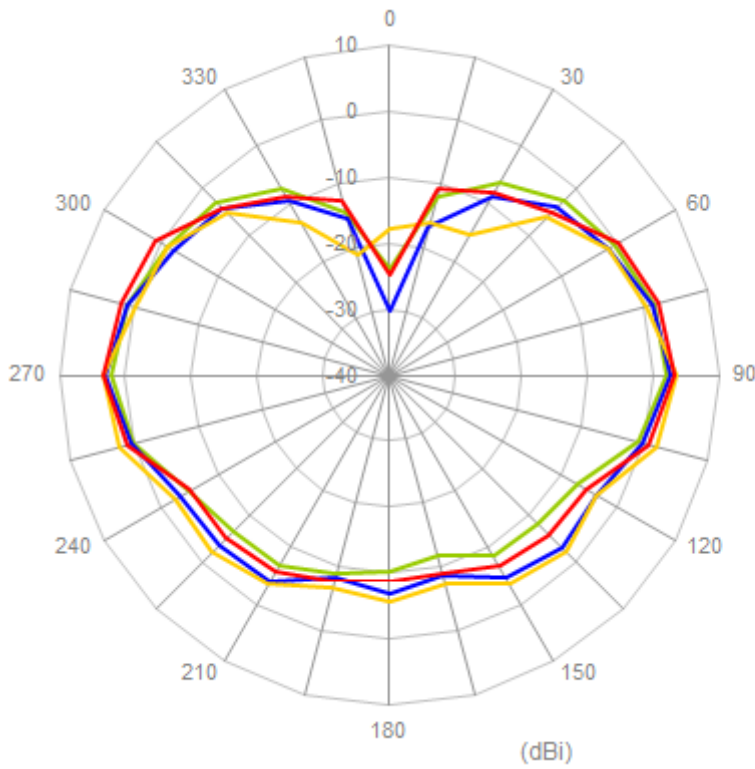

- 1710M Hz
- 1880M Hz
- 1990M Hz
- 2170M Hz

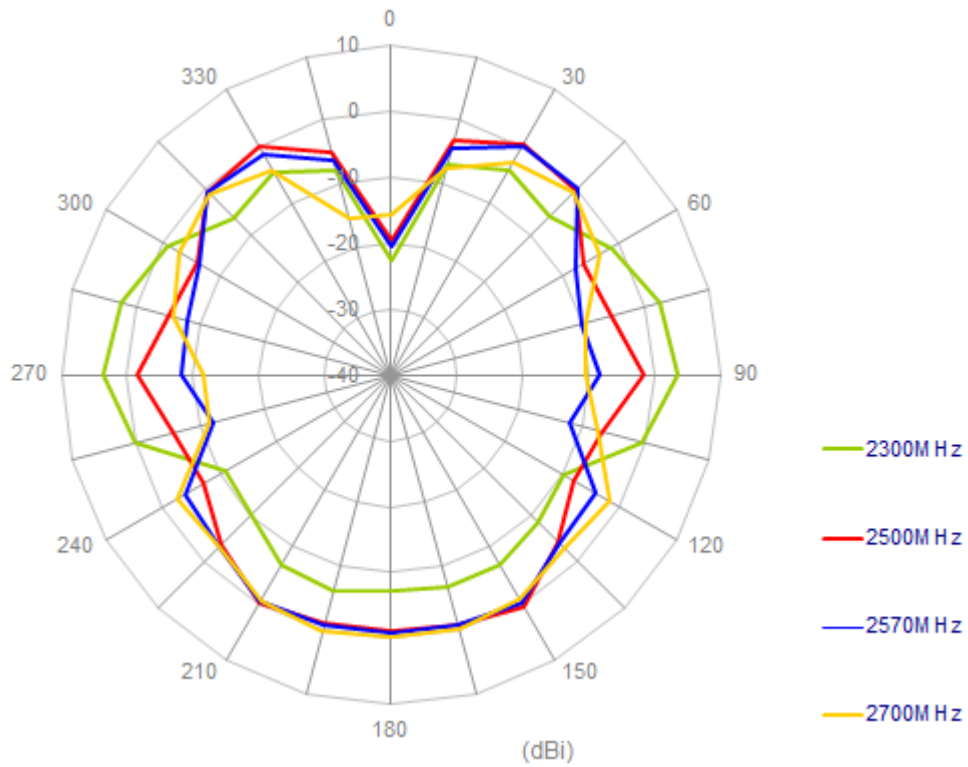

4.8 Antenna setup (On Ground edge bent)

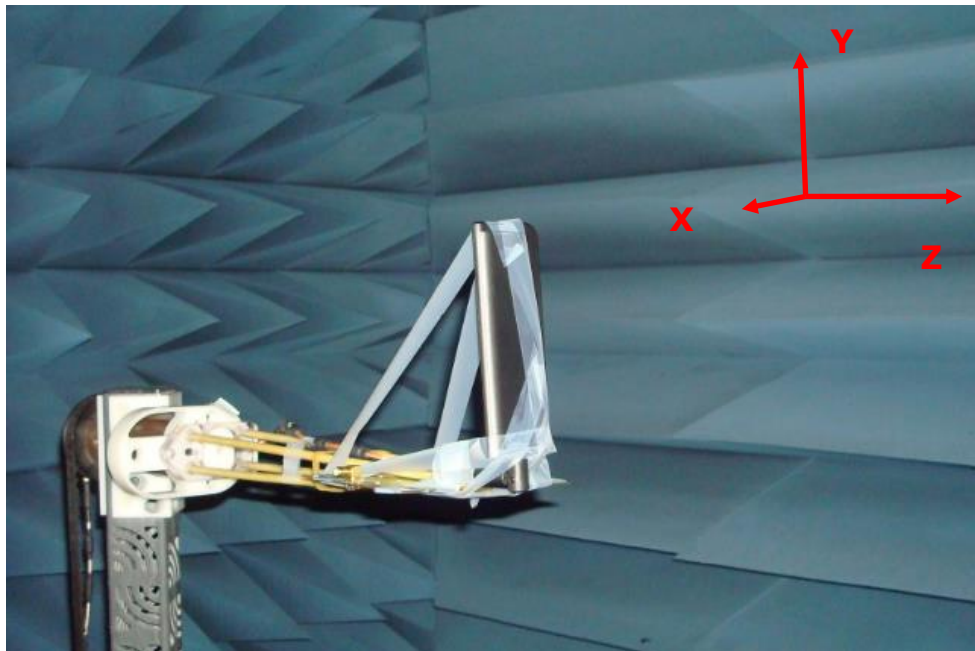

4.8.1 Radiation Patterns

XY Plane

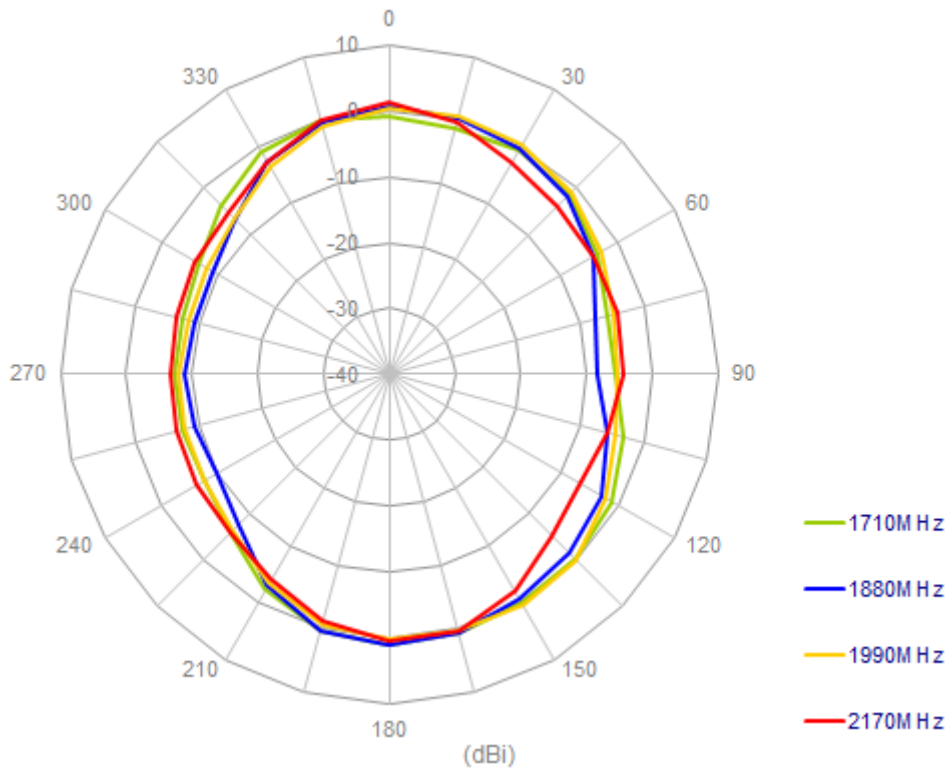
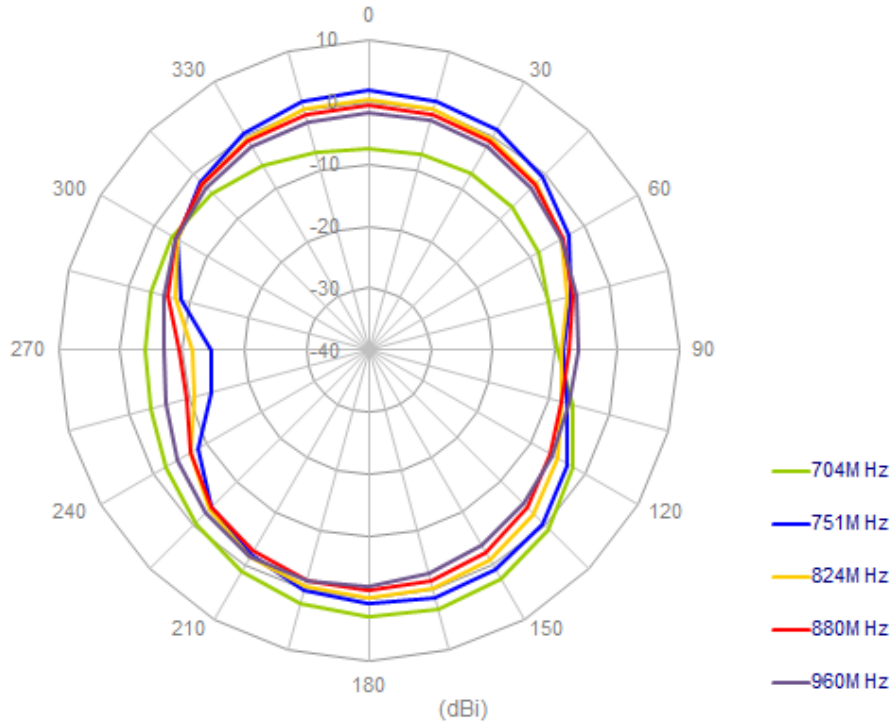

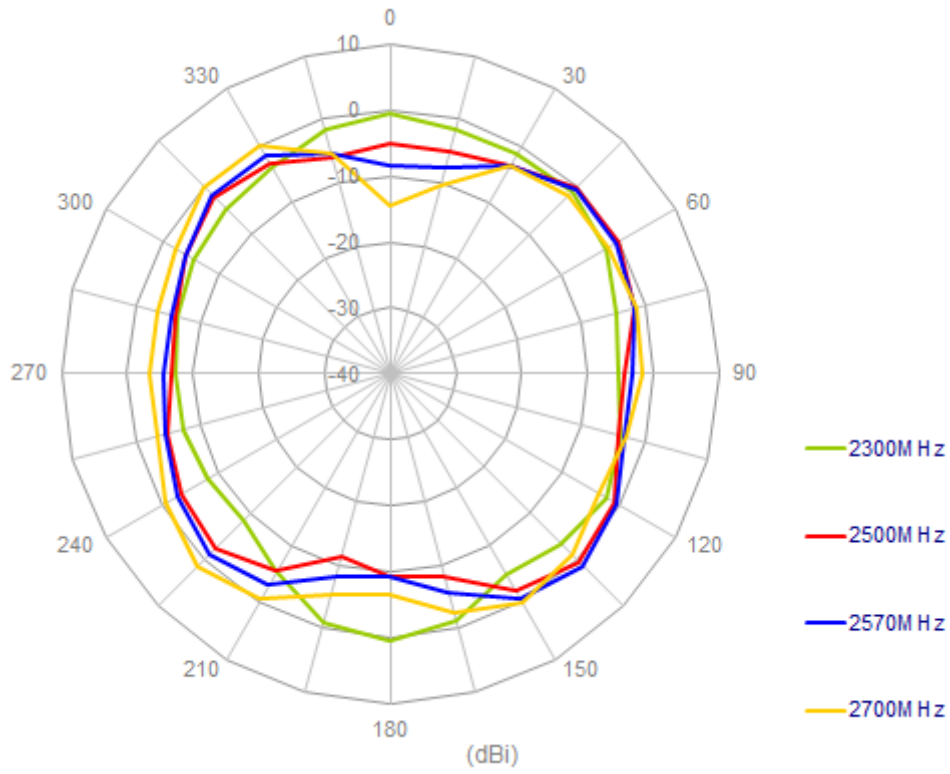

XZ Plane

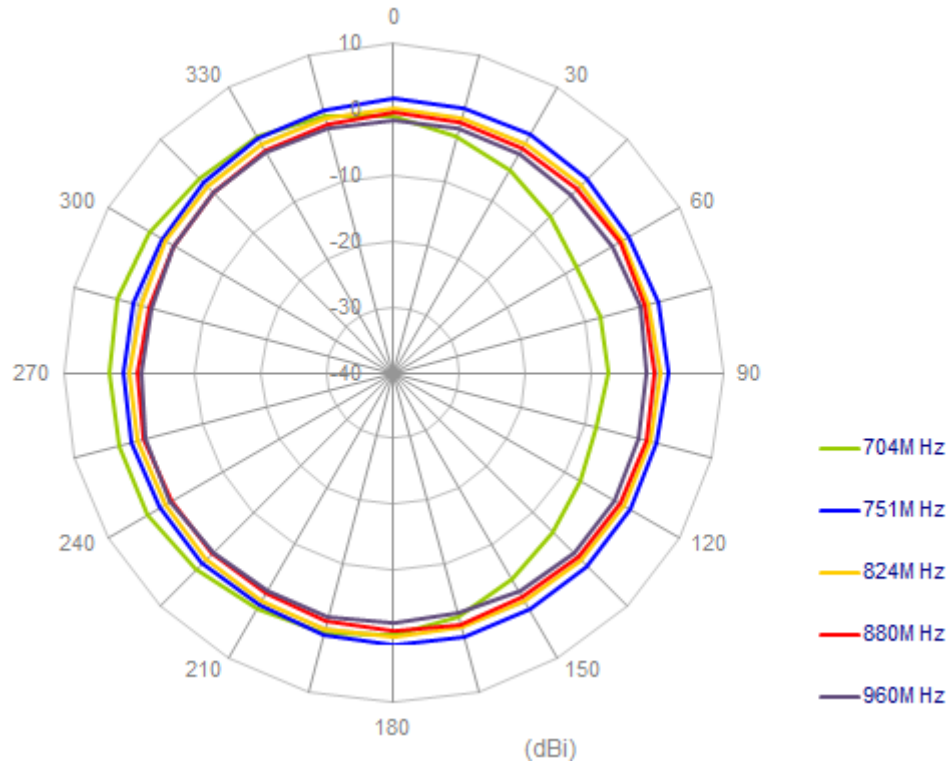

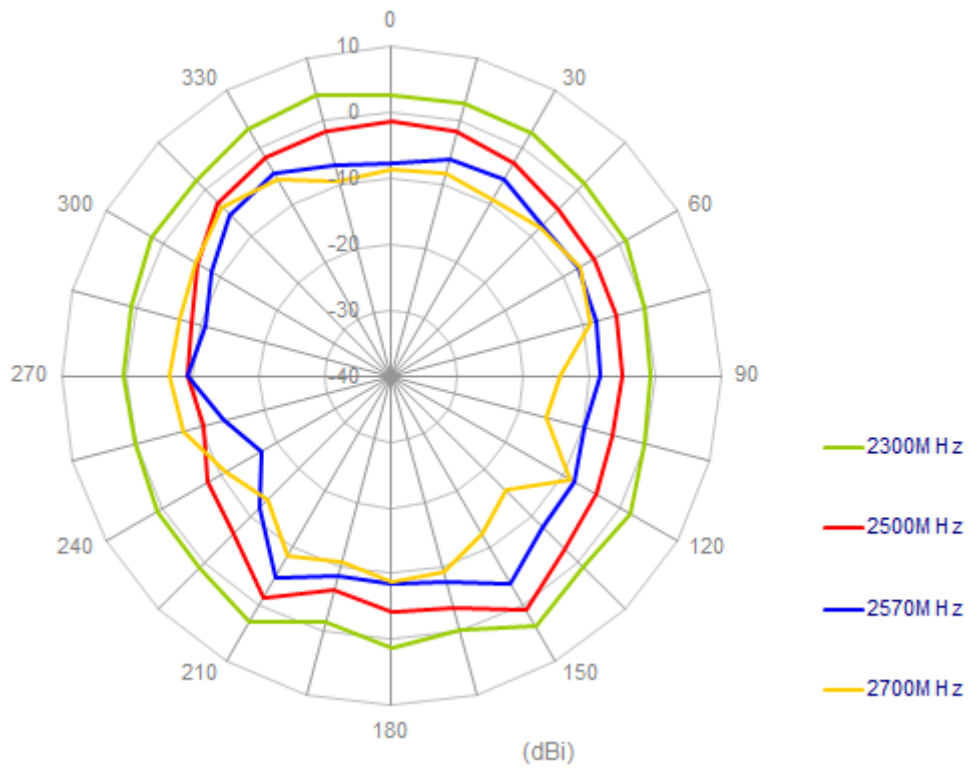
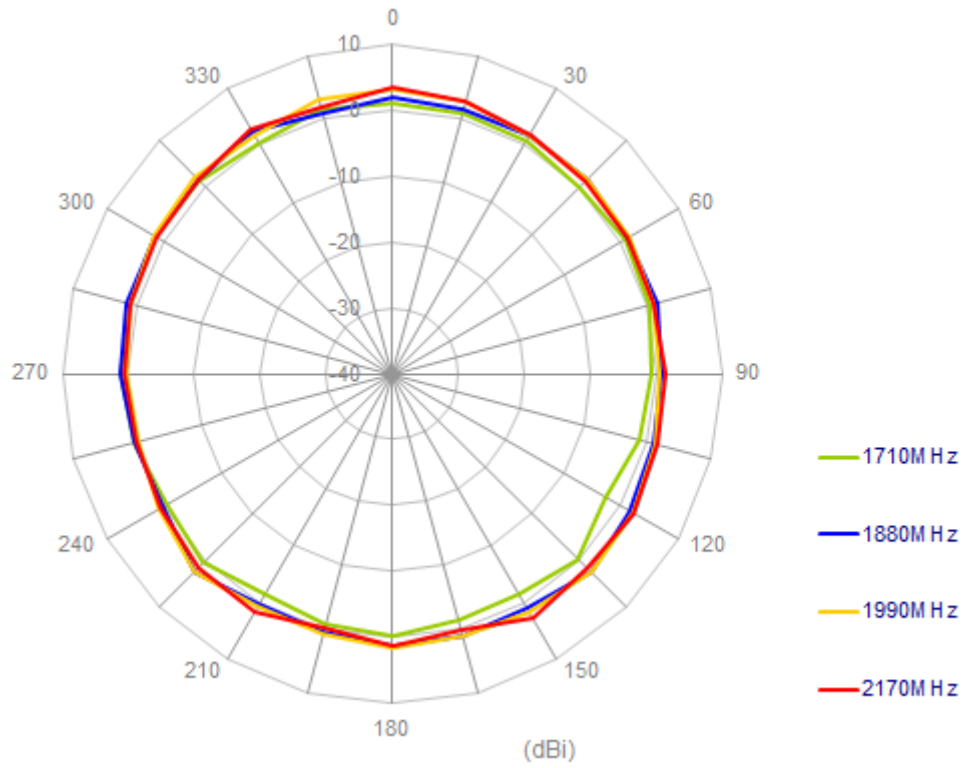

5. Mechanical Drawing

3D View

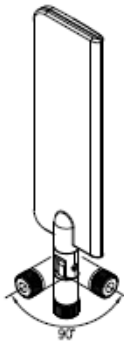

Front View

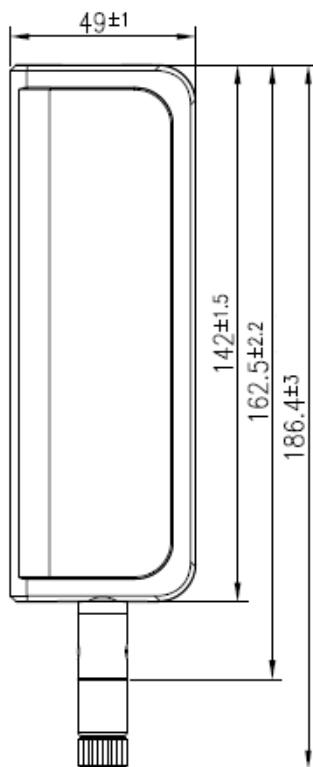

Side View

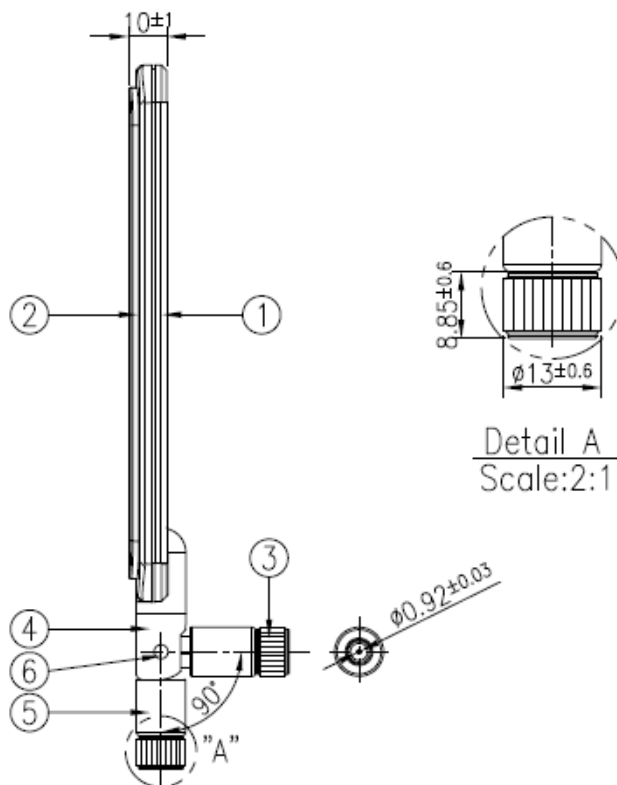

NOTES:

- 1.All material must be RoHS compliant.
- 2.Open/short, insertion loss QC required.
- 3.The connectors have a fixed orientation to each other.

| | Name | P/N | Material | Finish | QTY |
|---|----------------------|----------------|----------|--------|-----|
| 1 | Housing_Bottom_Hinge | 000112E020020A | ABS | Black | 1 |
| 2 | Housing_Top | 000112E000020A | ABS | Black | 1 |
| 3 | SMA(M)ST | 210212L010020A | Brass | Black | 1 |
| 4 | Hinge_Top | 000112E040020A | Nylon | Black | 1 |
| 5 | Hinge_Bottom | 000112E030020A | PC+PBT | Black | 1 |
| 6 | Rotary Shaft | 000611I000002A | Brass | Black | 2 |

6. Packaging



Taoglas makes no warranties based on the accuracy or completeness of the contents of this document and reserves the right to make changes to specifications and product descriptions at any time without notice. Taoglas reserves all rights to this document and the information contained herein.

Reproduction, use or disclosure to third parties without express permission is strictly prohibited.

Copyright © Taoglas Ltd.