



HL18L-P4A5BA

SureSense

CYLINDRICAL PHOTOELECTRIC SENSORS

SICK
Sensor Intelligence.



Illustration may differ



Ordering information

Type	Part no.
HL18L-P4A5BA	1071025

Other models and accessories → www.sick.com/SureSense

Detailed technical data

Features

Sensor/ detection principle	Photoelectric retro-reflective sensor, Dual lens
Dimensions (W x H x D)	16.2 mm x 48.5 mm x 31.8 mm
Housing design (light emission)	Hybrid
Thread diameter (housing)	M18
Sensing range max.	0.1 m ... 12 m ¹⁾
Sensing range	0.1 m ... 10 m ¹⁾
Type of light	Visible red light
Light source	Laser ^{2) 3)}
Light spot size (distance)	Ø 2 mm (5 m)
Wave length	655 nm
Laser class	I
Adjustment	None
Special applications	Detecting small objects
Special features	Signal strength light bar

¹⁾ Reflector PL80A.

²⁾ Average service life: 50,000 h at T_U = +25 °C.

³⁾ CLASS 1 LASER PRODUCT EN60825-1:2014; IEC60825-1:2014; Maximum pulse power < 2,5 mW, Pulse length: 4 µs, Wavelength: 650 ... 670 nm; Complies with 21 CFR 1040.10 and 1040.11 except for deviations pursuant to Laser Notice No. 50, dated June 24, 2007.

Mechanics/electronics

Supply voltage	10 V DC ... 30 V DC ^{1) 2)}
Ripple	< 5 V _{pp} ³⁾
Power consumption	20 mA ⁴⁾
Switching output	PNP ⁵⁾
Output function	Complementary
Switching mode	Light/dark switching ⁵⁾
Output current I_{max.}	≤ 100 mA
Response time	≤ 0.5 ms ⁶⁾
Switching frequency	1,000 Hz ⁷⁾
Connection type	Male connector M12, 4-pin
Circuit protection	A ⁸⁾ B ⁹⁾ D ¹⁰⁾
Protection class	III ¹¹⁾
Weight	18 g
Polarisation filter	✓
Housing material	Plastic, VISTAL®
Optics material	Plastic, PMMA
Enclosure rating	IP67 IP69K
Ambient operating temperature	-30 °C ... +55 °C ¹²⁾
Ambient storage temperature	-40 °C ... +75 °C
UL File No.	E189383

¹⁾ Above T_a 45 °C, max. voltage = 24 V and max. current = 50 mA.

²⁾ Limit values when operated in short-circuit protected network: max. 8 A.

³⁾ May not exceed or fall below U_v tolerances.

⁴⁾ Without signal strength light bar and load.

⁵⁾ Q1 = light switching; Q2 = dark switching.

⁶⁾ Signal transit time with resistive load.

⁷⁾ With light/dark ratio 1:1.

⁸⁾ A = V_S connections reverse-polarity protected.

⁹⁾ B = inputs and output reverse-polarity protected.

¹⁰⁾ D = outputs overcurrent and short-circuit protected.

¹¹⁾ Reference voltage: 50 V DC.

¹²⁾ Below T_a = -10 °C, sensor must be turned on at T_a > -10 °C. Sensor cannot be turned on below T_a = -10 °C.

Classifications

ECl@ss 5.0	27270902
ECl@ss 5.1.4	27270902
ECl@ss 6.0	27270902
ECl@ss 6.2	27270902
ECl@ss 7.0	27270902
ECl@ss 8.0	27270902
ECl@ss 8.1	27270902

ECl@ss 9.0	27270902
ETIM 5.0	EC002717
ETIM 6.0	EC002717
UNSPSC 16.0901	39121528

Connection diagram

Cd-243

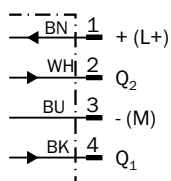

Characteristic curve

Operating reserve

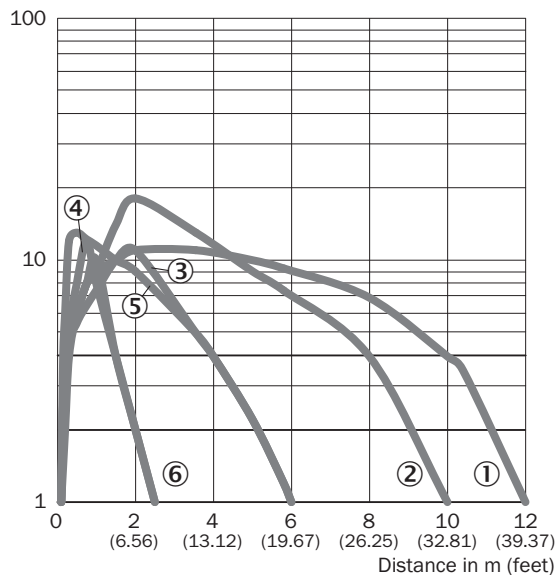

- ① Reflector PL80A
- ② Reflector P250F
- ③ PL10F reflector
- ④ Reflector PL23 FT
- ⑤ Reflective tape REF-AC1000
- ⑥ Reflective tape IREF6000 (REF-IRF-56)

Light spot size

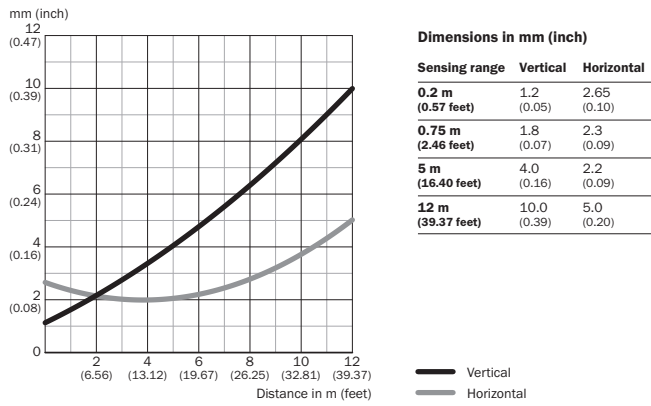

Sensing range diagram

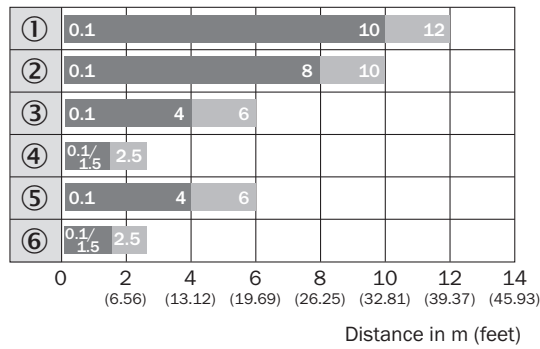

- Sensing range
- Sensing range max.
- ① Reflector PL80A
- ② Reflector P250F
- ③ PL10F reflector
- ④ Reflector PL23 FT
- ⑤ Reflective tape REF-AC1000
- ⑥ Reflective tape IREF6000 (REF-IRF-56)

Functions

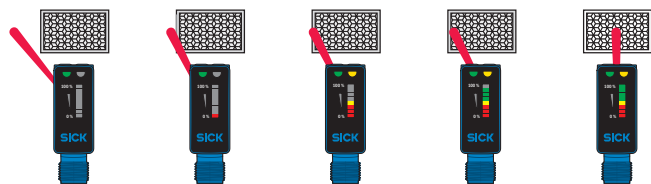

Dimensional drawing (Dimensions in mm (inch))

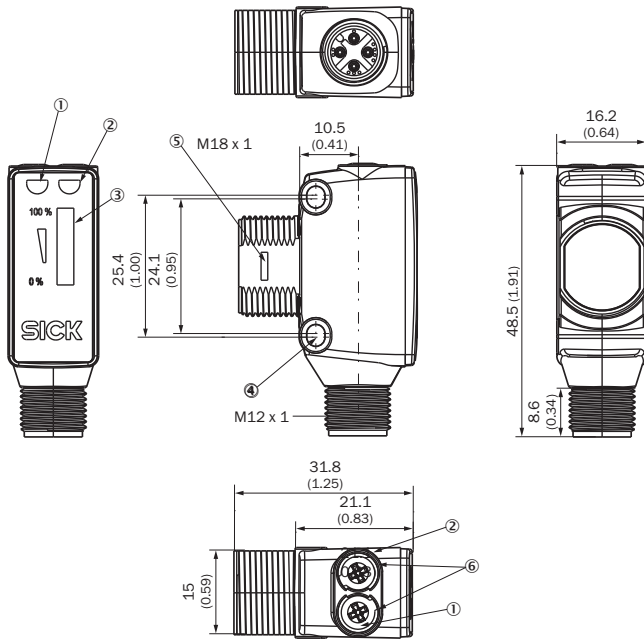

H18, DC, male connector M12



- ① LED indicator green: power on
- ② LED indicator yellow: Status of received light beam
- ③ Signal strength light bar
- ④ M3 mounting hole
- ⑤ Snap Connection for flush ring (sold separately)
- ⑥ Potentiometer (if selected) or LED Indicators

Recommended accessories

Other models and accessories → www.sick.com/SureSense

	Brief description	Type	Part no.
Mounting brackets and plates			
	Mounting plate for M18 sensors, steel, zinc coated, without mounting hardware	BEF-WG-M18	5321870
	Mounting bracket for M18 sensors, steel, zinc coated, without mounting hardware	BEF-WN-M18	5308446
	Bottom M18 mounting bracket SureSense sensors	MB-M18-H18	2085820
Other mounting accessories			
	Spherical bearing M18	Ball holder	4057409
	Mounting bracket	MB-BS18MM-M4	2049694
Terminal and alignment brackets			
	Clamping block for round sensors M18, without fixed stop, plastic (PA12), glass-fiber reinforced, mounting hardware included	BEF-KH-M18	2051481

	Brief description	Type	Part no.
Plug connectors and cables			
	Head A: female connector, M12, 4-pin, straight Head B: Flying leads Cable: PVC, unshielded, 2 m	DOL-1204-G02M	6009382
	Head A: female connector, M12, 4-pin, straight Head B: Flying leads Cable: PVC, unshielded, 5 m	DOL-1204-G05M	6009866
	Head A: female connector, M12, 4-pin, angled Head B: Flying leads Cable: PVC, unshielded, 2 m	DOL-1204-W02M	6009383
	Head A: female connector, M12, 4-pin, angled Head B: Flying leads Cable: PVC, unshielded, 5 m	DOL-1204-W05M	6009867
Reflectors			
	Fine triple reflector, screw connection, suitable for laser sensors, 47 mm x 47 mm, PM-MA/ABS, Screw-on, 2 hole mounting	P250F	5308843
	Fine triple, self-adhesive, suitable for laser sensors, Ø 23 mm, PMMA/ABS, self-adhesive	P25F-1	5319385
	Reflector with microprismatic reflex tape REF-AC1000, suitable for laser sensors, see alignment note, 23 mm x 23 mm, PMMA/ABS, Screw-on, 2 hole mounting	P41F	5315128
	Fine triple reflector, screw connection, suitable for laser sensors, 18 mm x 18 mm, PM-MA/ABS, Screw-on, 2 hole mounting	PL10F	5311210
	Fine triple reflector, screw connection, suitable for laser sensors, 38 mm x 16 mm, PM-MA/ABS, Screw-on, 2 hole mounting	PL20F	5308844
	Fine triple reflector, screw connection, suitable for laser sensors, 56 mm x 28 mm, PM-MA/ABS, Screw-on, 2 hole mounting	PL30F	5326523
	Fine triple reflector, screw connection, suitable for laser sensors, 76 mm x 45 mm, PM-MA/ABS, Screw-on, 2 hole mounting	PL81-1F	5325060
	Suitable for laser sensors, self-adhesive, cut, see alignment note, 56.3 mm x 56.3 mm, self-adhesive	REF-AC1000-56	4063030
	Fine triple reflector, chemically resistant, screw connection, 18 mm x 18 mm, Plastic, Screw-on, 2 hole mounting	PL10F CHEM	5321636
	Chemically resistant, screw connection, suitable for laser sensors, 16 mm x 38 mm, Plastic, Screw-on, 2 hole mounting	PL20F-CHEM	5326089

SICK AT A GLANCE

SICK is one of the leading manufacturers of intelligent sensors and sensor solutions for industrial applications. A unique range of products and services creates the perfect basis for controlling processes securely and efficiently, protecting individuals from accidents and preventing damage to the environment.

We have extensive experience in a wide range of industries and understand their processes and requirements. With intelligent sensors, we can deliver exactly what our customers need. In application centers in Europe, Asia and North America, system solutions are tested and optimized in accordance with customer specifications. All this makes us a reliable supplier and development partner.

Comprehensive services complete our offering: SICK LifeTime Services provide support throughout the machine life cycle and ensure safety and productivity.

For us, that is “Sensor Intelligence.”

WORLDWIDE PRESENCE:

Contacts and other locations –www.sick.com