



## GaAs InGaP HBT MMIC POWER AMPLIFIER, 2.2 - 2.8 GHz

### Typical Applications

This amplifier is ideal for use as a power amplifier for 2.2 - 2.7 GHz applications:

- BLUETOOTH
- MMDS

### Features

- Gain: 20 dB
- Saturated Power: +30 dBm
- 32% PAE
- Supply Voltage: +2.75V to +5V
- Power Down Capability
- Low External Part Count

### Functional Diagram

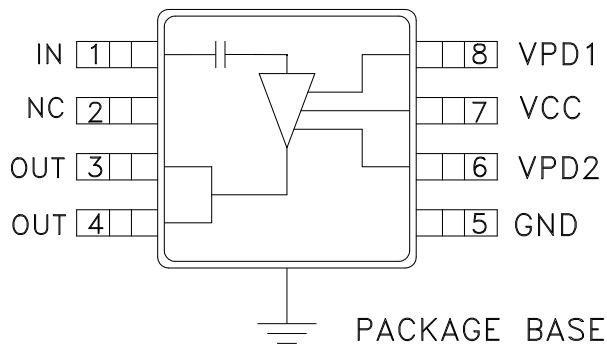

### General Description

The HMC414MS8G & HMC414MS8GE are high efficiency GaAs InGaP Heterojunction Bipolar Transistor (HBT) MMIC Power amplifiers which operate between 2.2 and 2.8 GHz. The amplifier is packaged in a low cost, surface mount 8 leaded package with an exposed base for improved RF and thermal performance. With a minimum of external components, the amplifier provides 20 dB of gain, +30 dBm of saturated power at 32% PAE from a +5V supply voltage. The amplifier can also operate with a 3.6V supply. Vpd can be used for full power down or RF output power/current control.

### Electrical Specifications, $T_A = +25^\circ C$ , As a Function of $V_s$ , $V_{pd} = 3.6V$

Parameter	$V_s = 3.6V$			$V_s = 5V$			Units
	Min.	Typ.	Max.	Min.	Typ.	Max.	
Frequency Range	2.2 - 2.8			2.2 - 2.8			GHz
Gain	17	20	25	17	20	25	dB
Gain Variation Over Temperature		0.03	0.04		0.03	0.04	dB/ °C
Input Return Loss		8			8		dB
Output Return Loss		9			9		dB
Output Power for 1 dB Compression (P1dB)	21	25		23	27		dBm
Saturated Output Power (P <sub>sat</sub> )		27			30		dBm
Output Third Order Intercept (IP3)	30	35		35	39		dBm
Noise Figure		6.5			7.0		dB
Supply Current (I <sub>cq</sub> )	V <sub>pd</sub> = 0V / 3.6V			0.002 / 300			mA
Control Current (I <sub>pd</sub> )	V <sub>pd</sub> = 3.6V			7			mA
Switching Speed	t <sub>ON</sub> , t <sub>OFF</sub>			45			ns

Information furnished by Analog Devices is believed to be accurate and reliable. However, no responsibility is assumed by Analog Devices for its use, nor for any infringements of patents or other rights of third parties that may result from its use. Specifications subject to change without notice. No license is granted by implication or otherwise under any patent or patent rights of Analog Devices. Trademarks and registered trademarks are the property of their respective owners.

For price, delivery, and to place orders: Analog Devices, Inc., One Technology Way, P.O. Box 9106, Norwood, MA 02062-9106  
Phone: 781-329-4700 • Order online at [www.analog.com](http://www.analog.com)  
Application Support: Phone: 1-800-ANALOG-D

# HMC414\* PRODUCT PAGE QUICK LINKS

Last Content Update: 02/23/2017

---

## COMPARABLE PARTS

View a parametric search of comparable parts.

## EVALUATION KITS

- HMC414MS8G Evaluation Board

## DOCUMENTATION

### Application Notes

- AN-1363: Meeting Biasing Requirements of Externally Biased RF/Microwave Amplifiers with Active Bias Controllers
- Broadband Biasing of Amplifiers General Application Note
- MMIC Amplifier Biasing Procedure Application Note
- Thermal Management for Surface Mount Components General Application Note

### Data Sheet

- HMC414 Data Sheet

## TOOLS AND SIMULATIONS

- HMC414 S-Parameter

## REFERENCE MATERIALS

### Quality Documentation

- HMC Legacy PCN: MS##, MS##E and MS##G,MS##GE packages - Relocation of pre-existing production equipment to new building
- Package/Assembly Qualification Test Report: MS8G (QTR: 2014-00393)
- PCN: MS, QS, SOT, SOIC packages - Sn/Pb plating vendor change
- Semiconductor Qualification Test Report: GaAs HBT-B (QTR: 2013-00229)

## DESIGN RESOURCES

- HMC414 Material Declaration
- PCN-PDN Information
- Quality And Reliability
- Symbols and Footprints

## DISCUSSIONS

View all HMC414 EngineerZone Discussions.

## SAMPLE AND BUY

Visit the product page to see pricing options.

## TECHNICAL SUPPORT

Submit a technical question or find your regional support number.

## DOCUMENT FEEDBACK

Submit feedback for this data sheet.

---



# HMC414MS8G / 414MS8GE

## GaAs InGaP HBT MMIC POWER AMPLIFIER, 2.2 - 2.8 GHz

**Gain vs. Temperature, Vs= 3.6V**

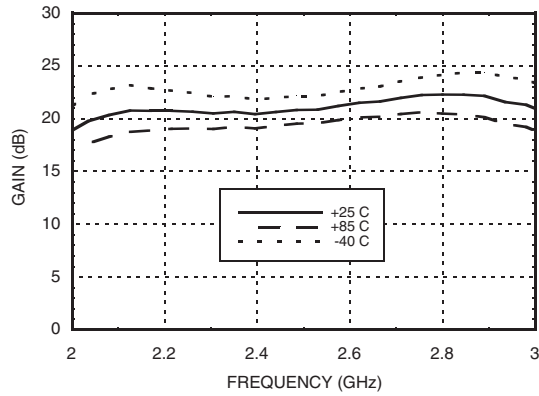

**Gain vs. Temperature, Vs= 5V**

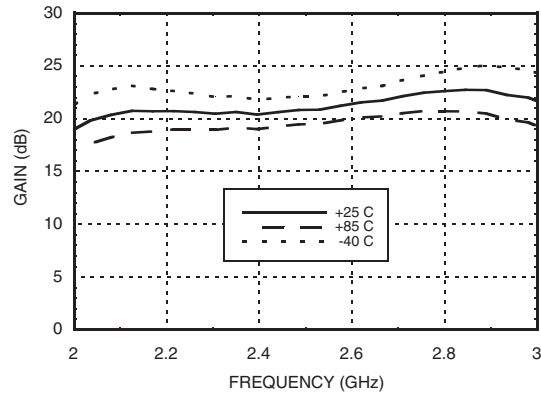

**Return Loss, Vs= 3.6V**

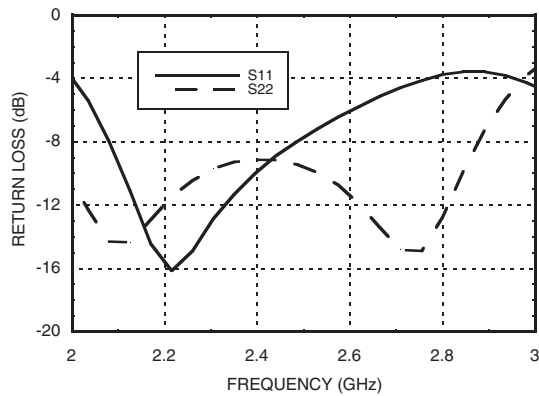

**Return Loss, Vs= 5V**

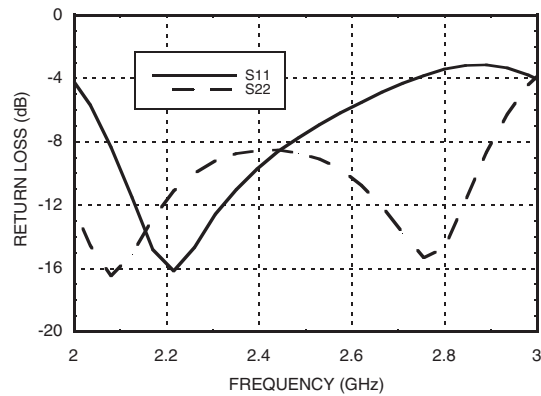

**P1dB vs. Temperature, Vs= 3.6V**

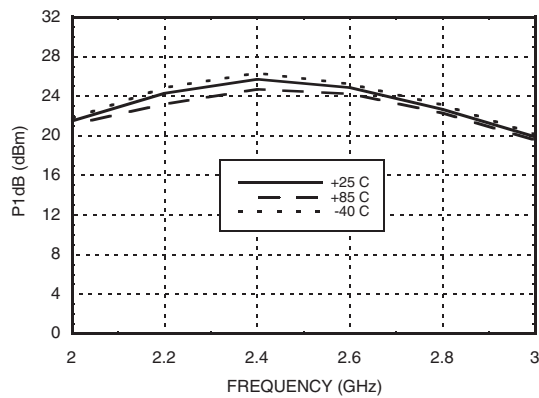

**P1dB vs. Temperature, Vs= 5V**

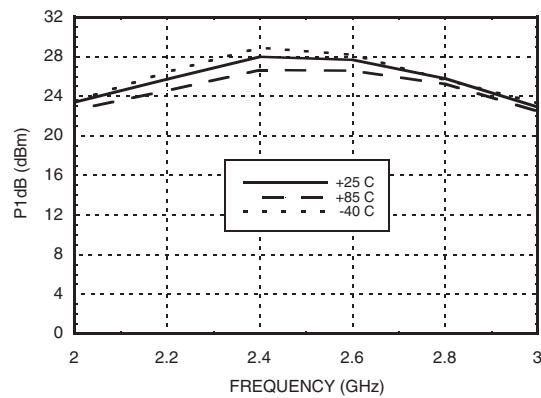

Information furnished by Analog Devices is believed to be accurate and reliable. However, no responsibility is assumed by Analog Devices for its use, nor for any infringements of patents or other rights of third parties that may result from its use. Specifications subject to change without notice. No license is granted by implication or otherwise under any patent or patent rights of Analog Devices. Trademarks and registered trademarks are the property of their respective owners.

For price, delivery, and to place orders: Analog Devices, Inc., One Technology Way, P.O. Box 9106, Norwood, MA 02062-9106 Phone: 781-329-4700 • Order online at [www.analog.com](http://www.analog.com) Application Support: Phone: 1-800-ANALOG-D



**HMC414MS8G / 414MS8GE**

**GaAs InGaP HBT MMIC  
POWER AMPLIFIER, 2.2 - 2.8 GHz**

**Psat vs. Temperature, Vs= 3.6V**

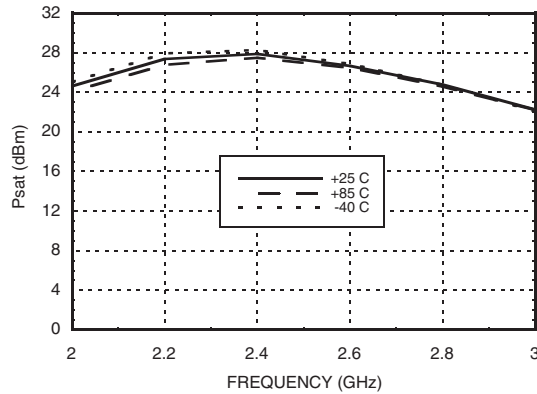

**Psat vs. Temperature, Vs= 5V**

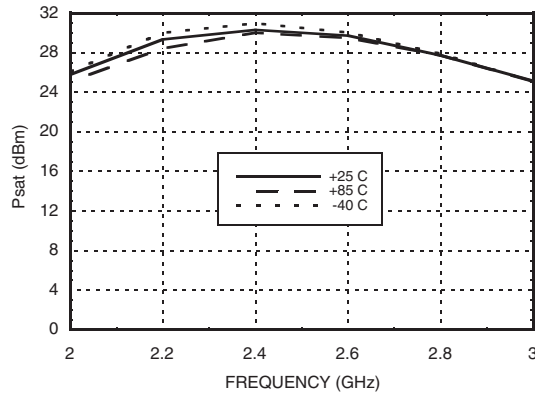

**Power Compression@ 2.4 GHz, Vs= 3.6V**

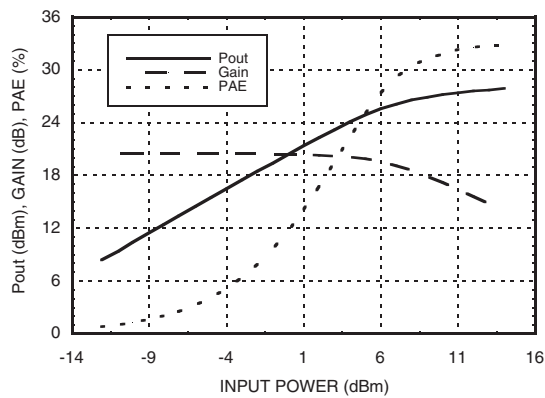

**Power Compression@ 2.4 GHz, Vs= 5V**

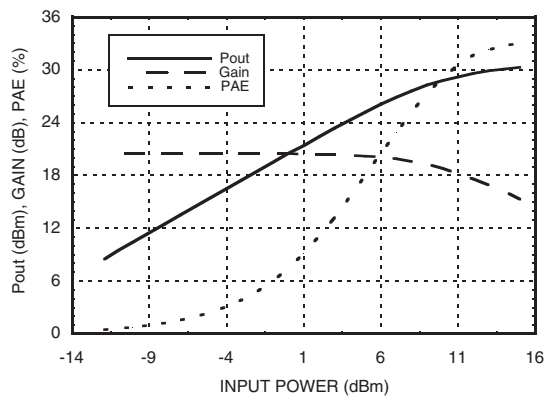

**Output IP3 vs. Temperature, Vs= 3.6V**

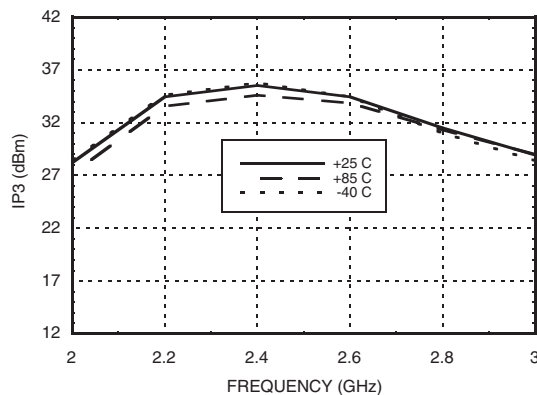

**Output IP3 vs. Temperature, Vs= 5V**

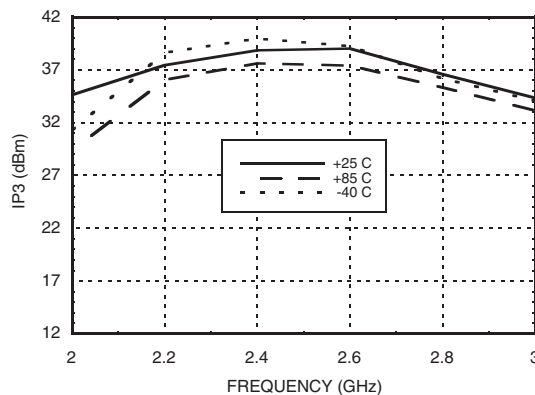

Information furnished by Analog Devices is believed to be accurate and reliable. However, no responsibility is assumed by Analog Devices for its use, nor for any infringements of patents or other rights of third parties that may result from its use. Specifications subject to change without notice. No license is granted by implication or otherwise under any patent or patent rights of Analog Devices. Trademarks and registered trademarks are the property of their respective owners.

For price, delivery, and to place orders: Analog Devices, Inc., One Technology Way, P.O. Box 9106, Norwood, MA 02062-9106 Phone: 781-329-4700 • Order online at [www.analog.com](http://www.analog.com) Application Support: Phone: 1-800-ANALOG-D



**GaAs InGaP HBT MMIC  
POWER AMPLIFIER, 2.2 - 2.8 GHz**

**Reverse Isolation vs. Temperature, Vs= 3.6V**

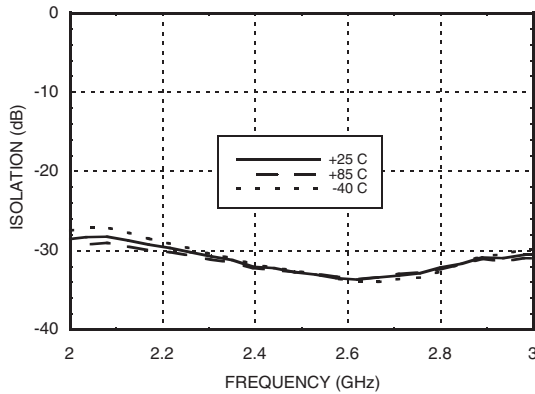

**Power Down Isolation, Vs= 3.6V**

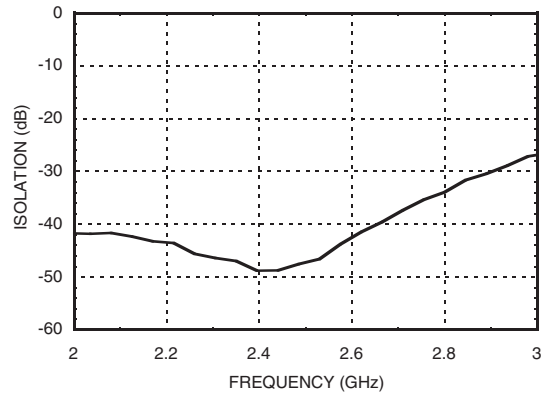

**Noise Figure vs. Temperature, Vs= 3.6V**

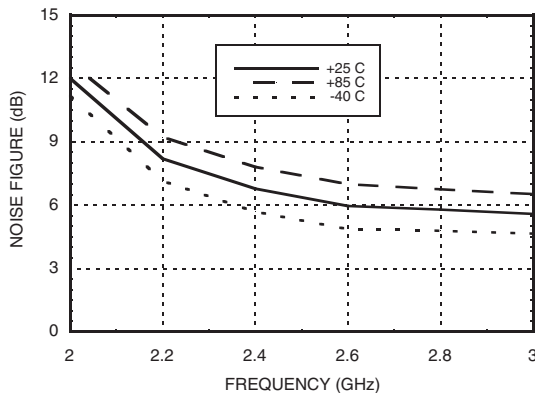

**Noise Figure vs. Temperature, Vs= 5V**

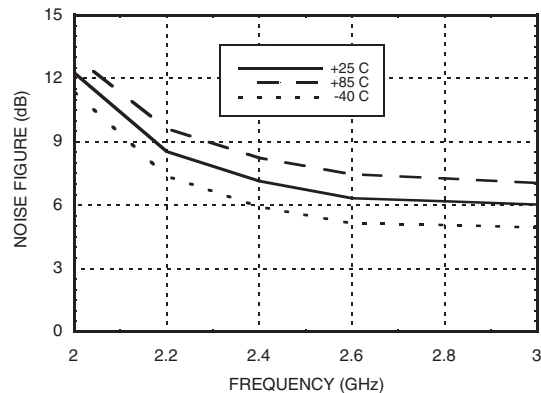

**Gain & Power vs. Supply Voltage**

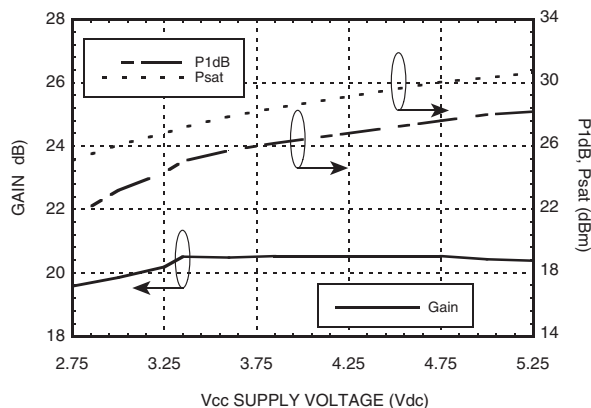

**Gain, Power & Quiescent Supply Current vs Vpd@ 2.4 GHz**

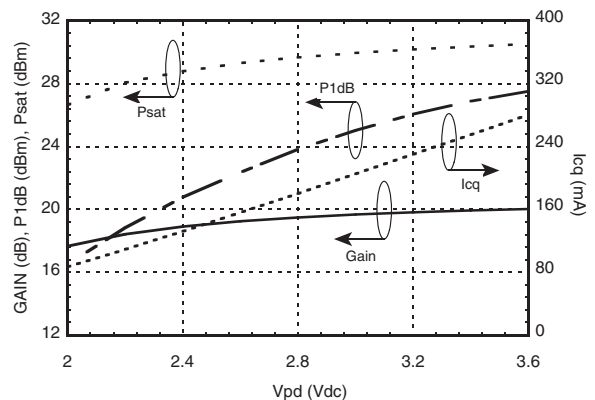

Information furnished by Analog Devices is believed to be accurate and reliable. However, no responsibility is assumed by Analog Devices for its use, nor for any infringements of patents or other rights of third parties that may result from its use. Specifications subject to change without notice. No license is granted by implication or otherwise under any patent or patent rights of Analog Devices. Trademarks and registered trademarks are the property of their respective owners.

For price, delivery, and to place orders: Analog Devices, Inc., One Technology Way, P.O. Box 9106, Norwood, MA 02062-9106 Phone: 781-329-4700 • Order online at [www.analog.com](http://www.analog.com) Application Support: Phone: 1-800-ANALOG-D



## GaAs InGaP HBT MMIC POWER AMPLIFIER, 2.2 - 2.8 GHz

### Absolute Maximum Ratings

Collector Bias Voltage (Vcc)	+5.5 Vdc
Control Voltage (Vpd1, Vpd2)	+4.0 Vdc
RF Input Power (RFIN)(Vs = +5.0, Vpd = +3.6 Vdc)	+17 dBm
Junction Temperature	150 °C
Continuous P <sub>diss</sub> (T = 85 °C) (derate 27 mW/°C above 85 °C)	1.755 W
Thermal Resistance (junction to ground paddle)	37 °C/W
Storage Temperature	-65 to +150 °C
Operating Temperature	-40 to +85 °C



ELECTROSTATIC SENSITIVE DEVICE  
OBSERVE HANDLING PRECAUTIONS

### Outline Drawing

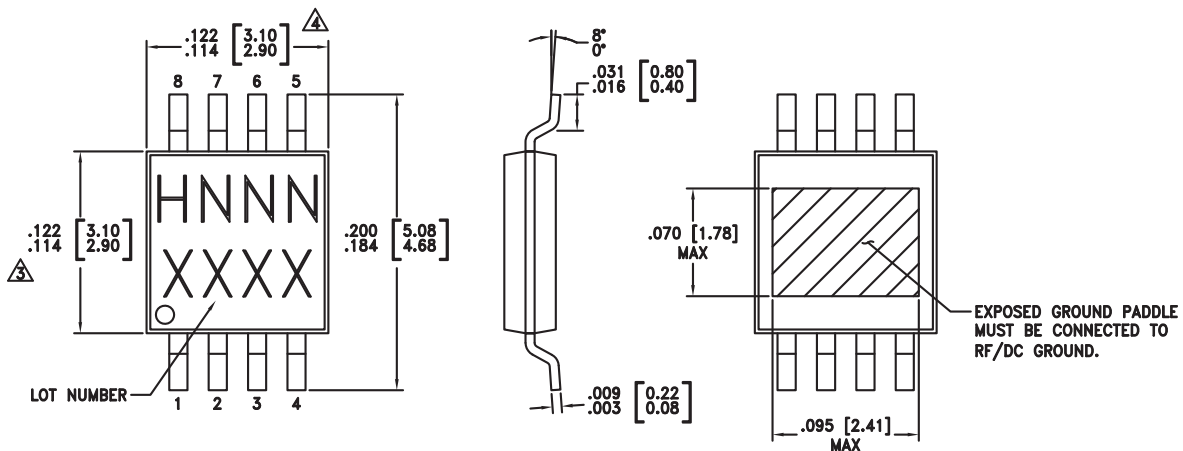

EXPOSED GROUND PADDLE  
MUST BE CONNECTED TO  
RF/DC GROUND.

NOTES:

- LEADFRAME MATERIAL: COPPER ALLOY
- DIMENSIONS ARE IN INCHES [MILLIMETERS].
- DIMENSION DOES NOT INCLUDE MOLDFLASH OF 0.15mm PER SIDE.
- DIMENSION DOES NOT INCLUDE MOLDFLASH OF 0.25mm PER SIDE.
- ALL GROUND LEADS AND GROUND PADDLE MUST BE SOLDERED TO PCB RF GROUND.

### Package Information

Part Number	Package Body Material	Lead Finish	MSL Rating	Package Marking <sup>[3]</sup>
HMC414MS8G	Low Stress Injection Molded Plastic	Sn/Pb Solder	MSL1 <sup>[1]</sup>	H414 XXXX
HMC414MS8GE	RoHS-compliant Low Stress Injection Molded Plastic	100% matte Sn	MSL1 <sup>[2]</sup>	H414 XXXX

[1] Max peak reflow temperature of 235 °C

[2] Max peak reflow temperature of 260 °C



[3] 4-Digit lot number XXXX

Information furnished by Analog Devices is believed to be accurate and reliable. However, no responsibility is assumed by Analog Devices for its use, nor for any infringements of patents or other rights of third parties that may result from its use. Specifications subject to change without notice. No license is granted by implication or otherwise under any patent or patent rights of Analog Devices. Trademarks and registered trademarks are the property of their respective owners.

For price, delivery, and to place orders: Analog Devices, Inc., One Technology Way, P.O. Box 9106, Norwood, MA 02062-9106  
Phone: 781-329-4700 • Order online at [www.analog.com](http://www.analog.com)  
Application Support: Phone: 1-800-ANALOG-D

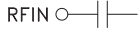
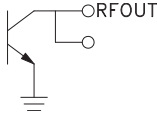

### Pin Descriptions

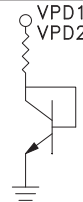
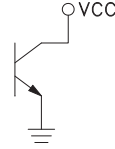
Pin Number	Function	Description	Interface Schematic
1	RFIN	This pin is AC coupled and matched to 50 Ohms.	
2	NC	Not Connected.	
3, 4	RFOUT	RF output and DC bias for the output stage.	
5	GND	Ground: Backside of package has exposed metal ground slug that must be connected to ground thru a short path. Vias under the device are required.	
6, 8	Vpd1, Vpd2	Power control pin. For maximum power, this pin should be connected to 3.6V. For 5V operation, a dropping resistor is required. A higher voltage is not recommended. For lower idle current, this voltage can be reduced.	
7	Vcc	Power supply voltage for the first amplifier stage. An external bypass capacitor of 330 pF is required as shown in the application schematic.	



**Evaluation PCB**

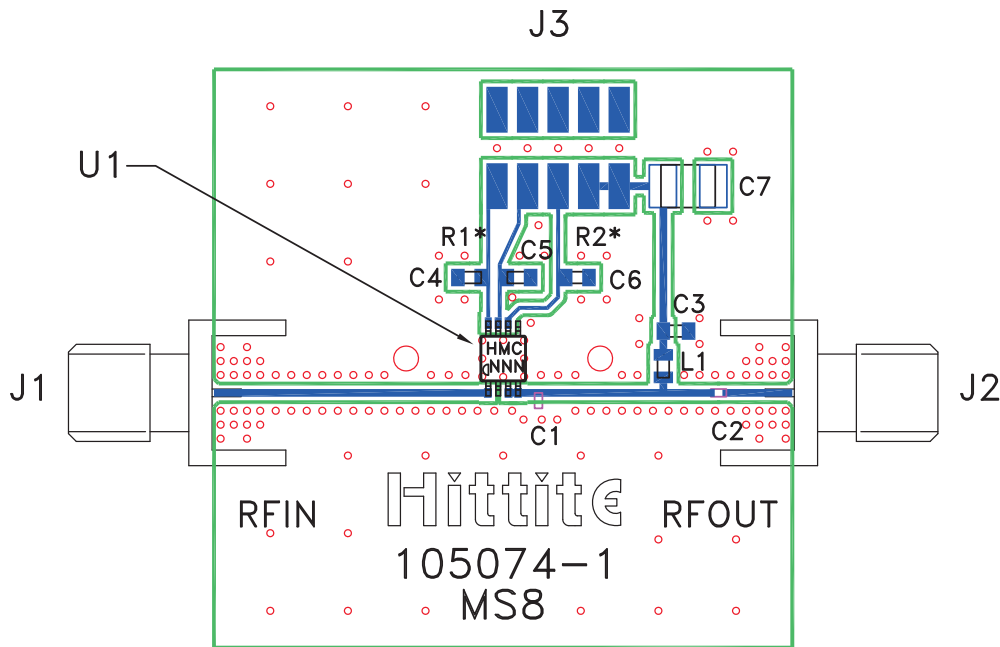

\* For 5V operation on Vctl line, select R1, R2 such that 3.6V is presented on Pins 6 and 8.

**List of Materials for Evaluation PCB 105006 [1]**

Item	Description
J1 - J2	PCB Mount SMA RF Connector
J3	2 mm DC Header
C1	2.7 pF Capacitor, 0603 Pkg.
C2	100 pF Capacitor, 0402 Pkg.
C3 - C6	330 pF Capacitor, 0603 Pkg.
C7	2.2 μF Capacitor, Tantalum
L1	18nH Inductor 0603 Pkg.
U1	HMC414MS8G / HMC414MS8GE Amplifier
PCB [2]	105074 Eval Board

The circuit board used in the final application should use RF circuit design techniques. Signal lines should have 50 ohm impedance while the package ground leads and exposed paddle should be connected directly to the ground plane similar to that shown. A sufficient number of via holes should be used to connect the top and bottom ground planes. The evaluation board should be mounted to an appropriate heat sink. The evaluation circuit board shown is available from Hittite upon request.

[1] Reference this number when ordering complete evaluation PCB

[2] Circuit Board Material: Rogers 4350





**GaAs InGaP HBT MMIC  
POWER AMPLIFIER, 2.2 - 2.8 GHz**

**Application Circuit**

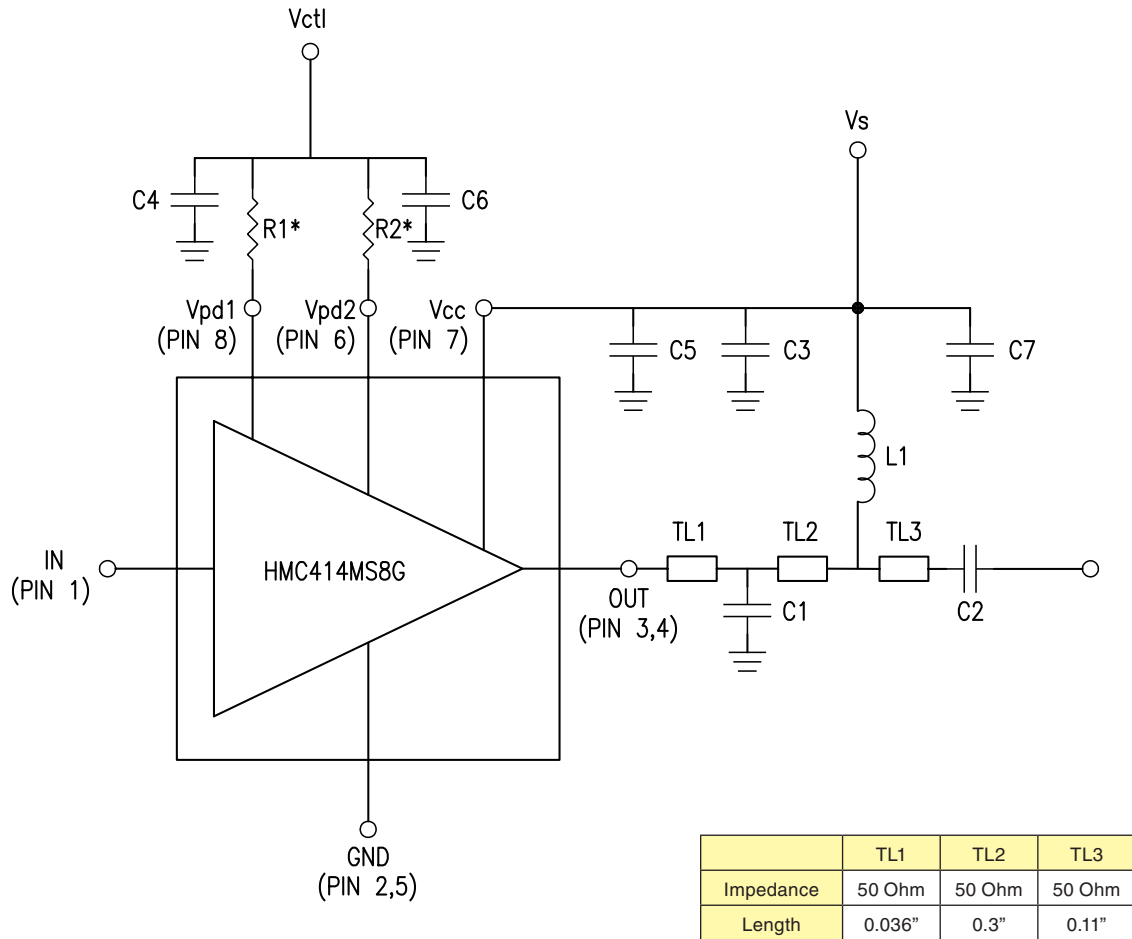

\* For 5V operation on Vctl line, select R1, R2 such that 3.6V is presented on Pins 6 and 8.