

PROCESS CP547
Power Transistor
PNP - Darlington Chip



PROCESS DETAILS

Process	EPITAXIAL PLANAR
Die Size	195 x 195 MILS
Die Thickness	11.4 MILS
Base Bonding Pad Area	29 x 29 MILS
Emitter Bonding Pad Area	61 x 35 MILS
Top Side Metalization	Al - 60,000Å
Back Side Metalization	Ti/Ni/Au - 1,100Å/4,000Å/500Å

GEOMETRY

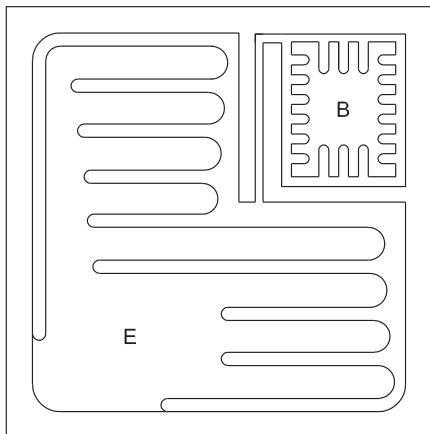

BACKSIDE COLLECTOR R2

GROSS DIE PER 5 INCH WAFER

400

PRINCIPAL DEVICE TYPES

MJ11011 2N6285
MJ11013 2N6286
MJ11015 2N6287

R5 (22-March 2010)

PROCESS CP547

Typical Electrical Characteristics

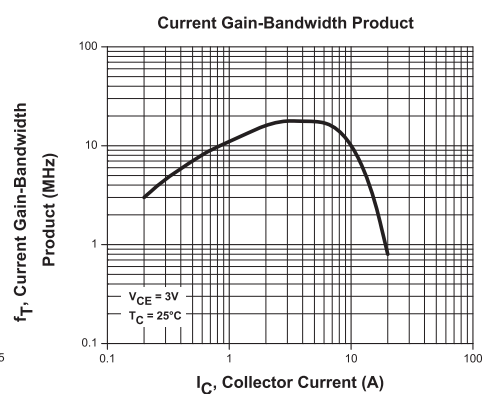
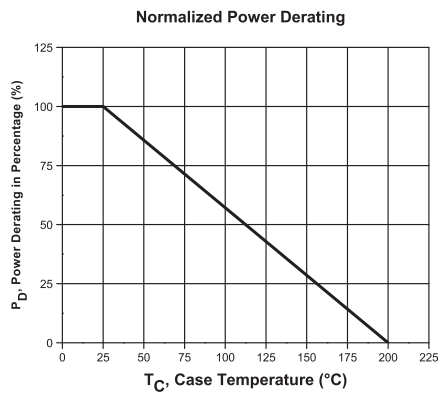
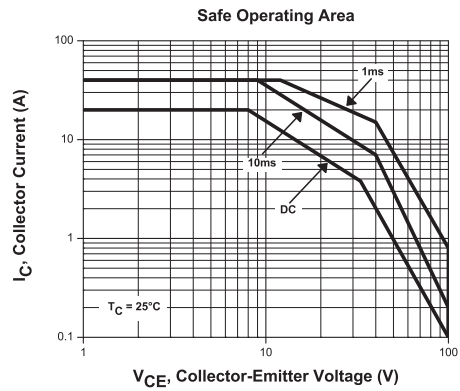
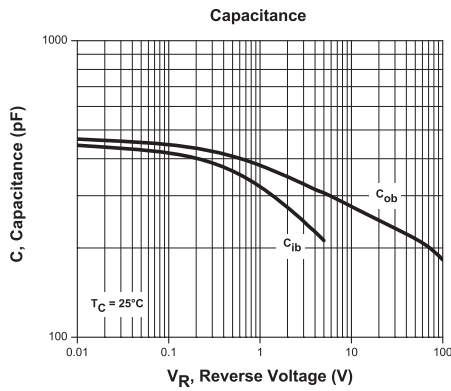
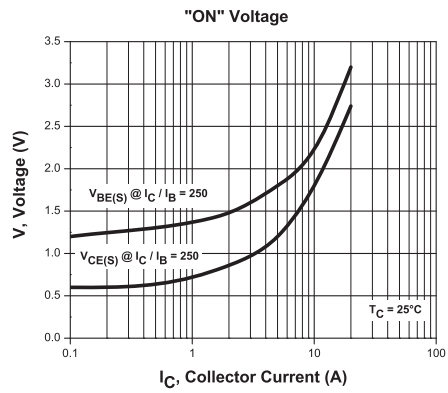
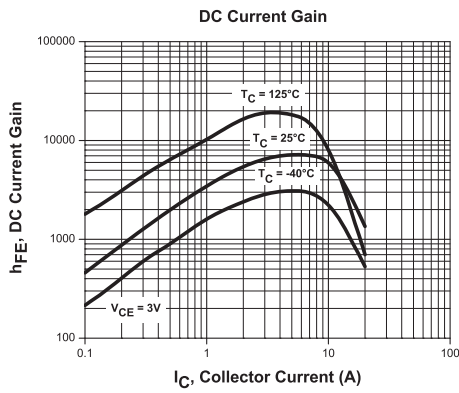

R5 (22-March 2010)

BARE DIE PACKING OPTIONS

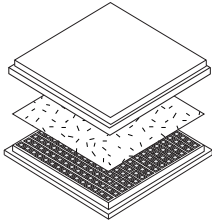

BARE DIE IN TRAY (WAFFLE) PACK

CT: Singulated die in tray (waffle) pack.
(example: CP211-PART NUMBER-CT)

CM: Singulated die in tray (waffle) pack 100% visually inspected as per MIL-STD-750, (method 2072 transistors, method 2073 diodes).
(example: CP211-PART NUMBER-CM)

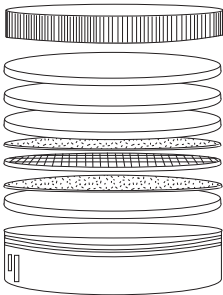

UNSAWN WAFER

WN: Full wafer, unsawn, 100% tested with reject die inked.
(example: CP211-PART NUMBER-WN)

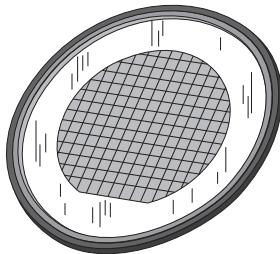

SAWN WAFER ON PLASTIC RING

WR: Full wafer, sawn and mounted on plastic ring,
100% tested with reject die inked.
(example: CP211-PART NUMBER-WR)

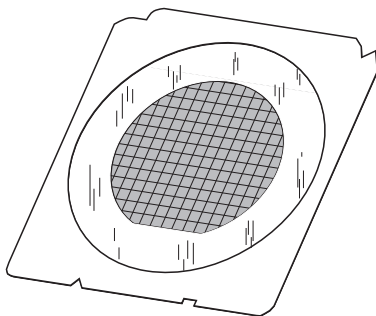

SAWN WAFER ON METAL FRAME

WS: Full wafer, sawn and mounted on metal frame,
100% tested with reject die inked.
(example: CP211-PART NUMBER-WS)

R0 (7-December 2015)

OUTSTANDING SUPPORT AND SUPERIOR SERVICES



PRODUCT SUPPORT

Central's operations team provides the highest level of support to insure product is delivered on-time.

- Supply management (Customer portals)
- Inventory bonding
- Consolidated shipping options
- Custom bar coding for shipments
- Custom product packing

DESIGNER SUPPORT/SERVICES

Central's applications engineering team is ready to discuss your design challenges. Just ask.

- Free quick ship samples (2nd day air)
- Online technical data and parametric search
- SPICE models
- Custom electrical curves
- Environmental regulation compliance
- Customer specific screening
- Up-screening capabilities
- Special wafer diffusions
- PbSn plating options
- Package details
- Application notes
- Application and design sample kits
- Custom product and package development

CONTACT US

Corporate Headquarters & Customer Support Team

Central Semiconductor Corp.
145 Adams Avenue
Hauppauge, NY 11788 USA
Main Tel: (631) 435-1110
Main Fax: (631) 435-1824
Support Team Fax: (631) 435-3388
www.centalsemi.com

Worldwide Field Representatives:
www.centalsemi.com/wwreps

Worldwide Distributors:
www.centalsemi.com/wwdistributors

For the latest version of Central Semiconductor's **LIMITATIONS AND DAMAGES DISCLAIMER**, which is part of Central's Standard Terms and Conditions of sale, visit: www.centalsemi.com/terms

Product End of Life Notification

PDN ID:	PDN01060
Notification Date:	11/14/16
Last Buy Date:	5/14/17
Last Shipment Date	11/14/17

Summary: The CP547 wafer process is being discontinued and is now classified as End of Life (EOL); replacement wafer process is CP647.

Although Central Semiconductor Corp. makes every effort to continue to produce devices that have been proclaimed EOL (End of Life) by various manufacturers, it is an accepted industry practice to discontinue certain devices when customer demand falls below a minimum level of sustainability. Accordingly, the following product(s) have been transitioned to End of Life status as part of Central's Product Management Process. Any replacement product will be noted below. The effective date for placing the last purchase order will be six(6) months from the date of this notice and twelve(12) months from the notice date for final shipments; this may be extended if inventory is available.

<u>Central Part Number</u>	<u>Replacement</u>
CP547-CEN1103-CT	CP647-CEN1103-CT
CP547-CEN1103-WN	CP647-CEN1103-WN
CP547-CEN1103-WS	CP647-CEN1103-WS
CP547-MJ11013-CT	CP647-MJ11013-CT
CP547-MJ11013-WS	CP647-MJ11013-WS
CP547-MJ11015-CT	CP647-MJ11015-CT
CP547-MJ11015-CTJ28	CP647-MJ11015-CTJ28
CP547-MJ11015-WN	CP647-MJ11015-WN
CP547-MJ11015-WR	CP647-MJ11015-WR
CP547-PMD19K100-CT	CP647-PMD19K100-CT
CP547-PMD19K100-WN	CP647-PMD19K100-WN
CP547-PMD19K100-WS	CP647-PMD19K100-WS
CP547-2N6287-CM	CP647-2N6287-CM
CP547-2N6287-CT	CP647-2N6287-CT
CP547-2N6287-WN	CP647-2N6287-WN

Central would be happy to assist you by providing additional information or technical data to help locate an alternate source if we have no replacement available. Please email your requests to engineering@centrasemi.com.

DISCLAIMER: This End of Life (EOL) notification is in accordance with JEDEC standard JESD48 - Product Discontinuance. Central Semiconductor Corp. will make every effort to offer life-time buy (LTB) opportunities and/or offer replacement devices to existing customers for discontinued devices, however, one or both may not be possible for all devices. Please contact your local Central Semiconductor sales representative for LTB opportunities/additional information.