

## SUMMARY

### # Wires

Low	4
High	0
Coax	0
Triax	0
Quad	0
Fiber	0
Fluidic	0

Series	0B
Termination type	Male solder
IP rating	50
Cable Ø	4.30 - 5.20 mm
Matching parts	EGG.0B.304.CLL
Status	
Alternative part	



*Image is for illustrative purpose only*

### Download

[Request a quote](#)

[Catalog](#)

## TECHNICAL DETAILS

### Mechanics

Shell Style/Model	FG*: Straight plug, cable collet
Keying	1 key (alpha=0, plug: male contacts, receptacle: female contacts)
Housing Material	Brass (chrome plated) shell and collet nut, nickel plated brass latch sleeve and mid pieces
Cable Fixing	D52: 4.3 - 5.2 mm
Variant	

### Performance

Configuration	0B.304 : 4 Low Voltage
Insulator	L: PEEK (UL 94 / V-0/3.2, depends on material thickness)
Rated Current	7 Amps

### Specifications

Contact Type:	Solder
Max. Matings:	5000
Contact Dia.:	0.7 mm (0.028in)
Bucket Dia.:	0.8 mm (0.031in)
Max. Stranded Conductor:	0.34 mm <sup>2</sup> (AWG 22)
Max. Conductor:	0.34 mm <sup>2</sup> (AWG 22)

R (max): 6.1 mOhm  
Vtest (contact-contact): 850 V (AC), 1200 V (DC)  
Vtest (contact-shell): 1100 V (AC), 1560 V (DC)

## Others

Endurance (Shell): 5000  
Temp (min / max): -55°C / +250°C  
Humidity (max): <=95% [at 60 deg C / 140 F]  
Vibration: 15 g [10 Hz - 2000 Hz]  
Shock Resistance: 100 g [ 6 ms]  
Salt Spray Corrosion: >1000 hr  
Climatical Category: 50/175/21  
Shielding (min): 75 dB (10 MHz)  
Shielding (min): 40 dB (1 GHz)  
IP Rating: 50

---

## DRAWINGS

### Draws

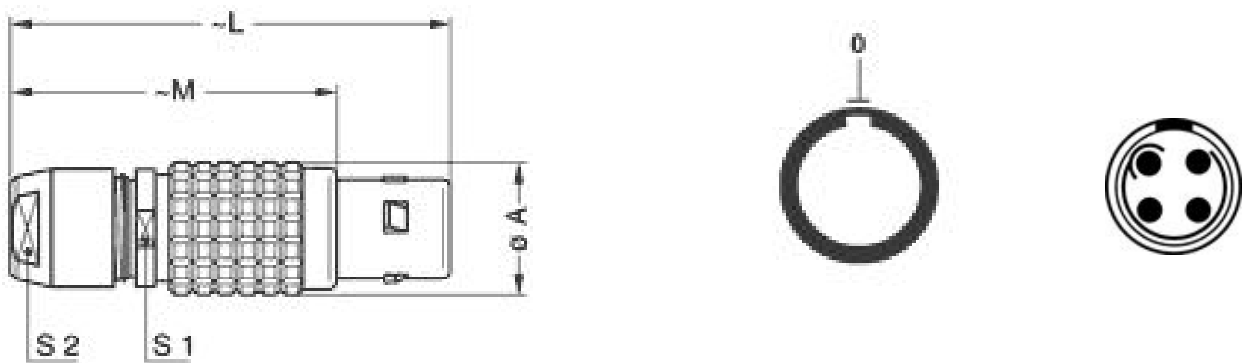

### Dimensions

	A	L	M	S1	S2
mm.	9.5	36	26	8	7
in.	0,37	1,42	1,02	0,31	0,28









---

## RECOMMENDED BY LEMO

### Tools

Spanner wrench: DCD.0B.005.PA070  
Caps: BFG.0B.100.PCSG

## Cables

CMN.04.T22.047PGCE	PVC	GREY	
CMN.04.T22.047PGZE		Grey	
CMN.04.T22.047PNCE	PVC	Black	
CMN.04.T22.047PNZE			
CMN.04.T22.047QGC	TPR	Grey	
CMN.04.T22.048QGZE	TPR (medical)	Grey	
004 080	PVC	Grey	
004 221	PVC	Black	
004 280	PVC	Black	
040 260	PVC	Black	
080 080	PVC	Grey	
080 082	PVC	Red	
080 084	PVC	Black	
140 240	PVC	Black	
140 250	PVC	Grey	