

# Digital Fiber Sensor FX-100 SERIES

Related Information

- General terms and conditions..... F-7
- Sensor selection guide..... P.3~
- Glossary of terms / General precautions..... P.1455~ / P.1501
- Fiber selection..... P.5~

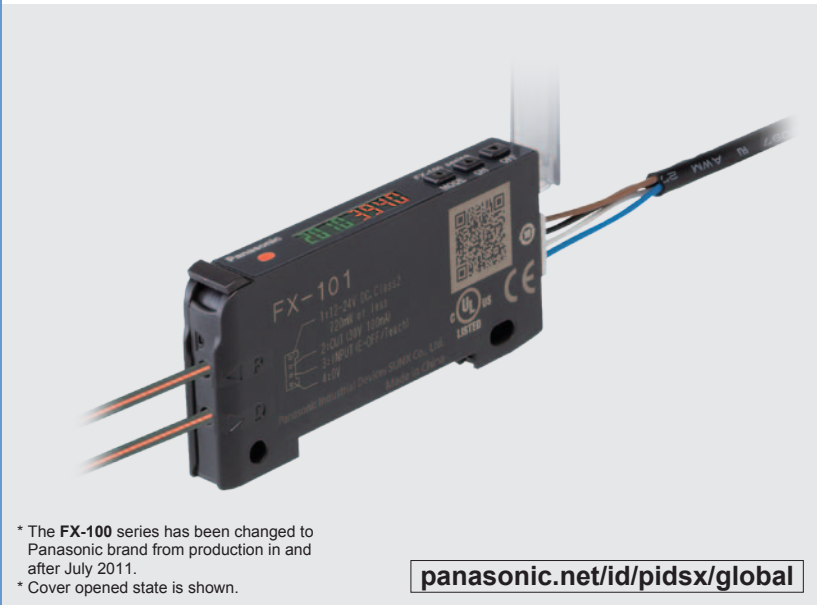

\* The FX-100 series has been changed to Panasonic brand from production in and after July 2011.  
\* Cover opened state is shown.

[panasonic.net/id/pidsx/global](http://panasonic.net/id/pidsx/global)

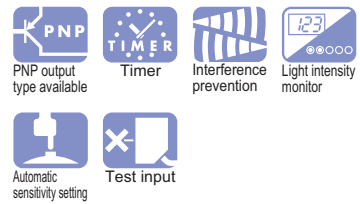

## Taking fiber sensors to the next level

### Good dual digital display

The threshold value and incident light intensity can be both confirmed at the same time, bringing good operability when making changes of each setting.



### Commercially-available connectors reduce lead time and spare part numbers

Compatible with commercially-available connectors, so that processing costs and lead time required for processing after purchase can be greatly reduced. The connection parts same as the DP-100 series digital pressure sensors and the PM-64 series micro photoelectric sensors can be commonly used.

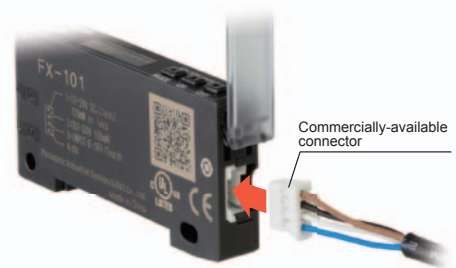

Commercially-available crimping connectors are used, so that the processing costs for connection cables can be greatly reduced.

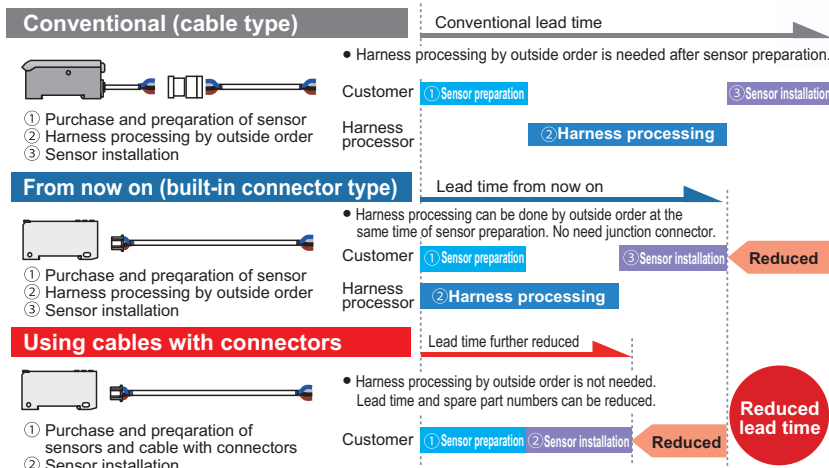

- Selection Guide
- Fibers
- Fiber Amplifiers

- FX-500
- FX-100**
- FX-300
- FX-410
- FX-311
- FX-301-F7/
- FX-301-F

- FIBER SENSORS
- LASER SENSORS
- PHOTOELECTRIC SENSORS
- MICRO PHOTOELECTRIC SENSORS
- AREA SENSORS
- LIGHT CURTAINS / SAFETY COMPONENTS
- PRESSURE / FLOW SENSORS
- INDUCTIVE PROXIMITY SENSORS
- PARTICULAR USE SENSORS
- SENSOR OPTIONS
- SIMPLE WIRE-SAVING UNITS
- WIRE-SAVING SYSTEMS
- MEASUREMENT SENSORS
- STATIC ELECTRICITY PREVENTION DEVICES
- LASER MARKERS
- PLC
- HUMAN MACHINE INTERFACES
- ENERGY CONSUMPTION VISUALIZATION COMPONENTS
- FA COMPONENTS
- MACHINE VISION SYSTEMS
- UV CURING SYSTEMS

### Saving-space with a width of 9 mm 0.354 in

Very slim body at only 9 mm 0.354 in. This is much thinner than existing fiber sensors. This makes a very large difference when using many units, even if the difference of one unit is small.

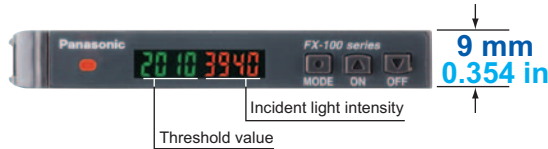

### Improved stability over long terms

Utilizes “Four-chemical emitting element” for light emission. The light emission is guaranteed to be stable over long periods of time.

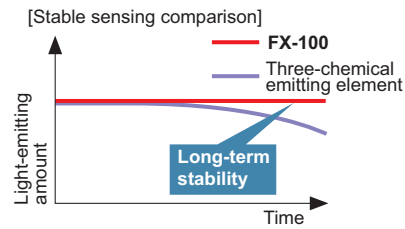

### Simple operation due to clear configuration system

Continued to use the configuration system of digital pressure sensor **DP-100** series, which has received high popularity since its release. We have separated the settings into three levels: RUN mode, SET mode, and PRO mode, making operation simpler and easier.

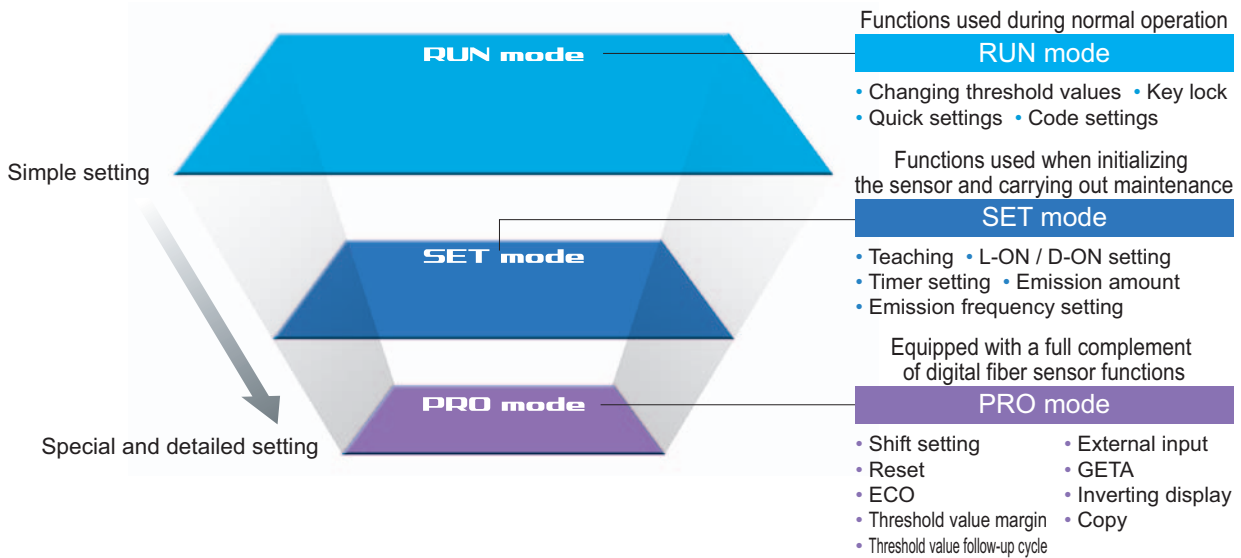

### Quick code input function

Simply inputting the default setting “code (number)” will enable sensor settings. Even if the settings are accidentally changed, inputting the code will restore the default settings. Confirmation can be carried out smoothly via telephone by simply quoting numbers. This can be of great assistance when dealing with foreign country customers.



**RUN mode**



Quick setting: Press and simultaneously for 2 sec.

Code setting: Press and simultaneously for 4 sec.

#### Quick setting numbers (abstract)

No	Output operation	Timer	Emission amount setting
-00-	Dark-ON	None	OFF
-01-	Dark-ON	None	ON
-02-	Dark-ON	OFF-delay 10 ms	OFF
-03-	Dark-ON	OFF-delay 10 ms	ON
-10-	Light-ON	ON-delay 40 ms	ON
-11-	Light-ON	ON-delay 40 ms	OFF
-12-	Light-ON	ON-delay 10 ms	ON
-13-	Light-ON	ON-delay 10 ms	OFF

Refer to “Quick setting function” and “Code setting function” in “PRECAUTIONS FOR PROPER USE” for details.

FIBER SENSORS

LASER SENSORS

PHOTOELECTRIC SENSORS

MICRO PHOTOELECTRIC SENSORS

AREA SENSORS

LIGHT CURTAINS / SAFETY COMPONENTS

PRESSURE / FLOW SENSORS

INDUCTIVE PROXIMITY SENSORS

PARTICULAR USE SENSORS

SENSOR OPTIONS

SIMPLE WIRE-SAVING UNITS

WIRE-SAVING SYSTEMS

MEASUREMENT SENSORS

STATIC ELECTRICITY PREVENTION DEVICES

LASER MARKERS

PLC

HUMAN MACHINE INTERFACES

ENERGY CONSUMPTION VISUALIZATION COMPONENTS

FA COMPONENTS

MACHINE VISION SYSTEMS

UV CURING SYSTEMS

Selection Guide

Fibers

Fiber Amplifiers

**FX-500**

**FX-100**

**FX-300**

**FX-410**

**FX-311**

**FX-301-F7/ FX-301-F**

- FIBER SENSORS
- LASER SENSORS
- PHOTOELECTRIC SENSORS
- MICRO PHOTOELECTRIC SENSORS
- AREA SENSORS
- LIGHT CURTAINS / SAFETY COMPONENTS
- PRESSURE / FLOW SENSORS
- INDUCTIVE PROXIMITY SENSORS
- PARTICULAR USE SENSORS
- SENSOR OPTIONS
- SIMPLE WIRE-SAVING UNITS
- WIRE-SAVING SYSTEMS
- MEASUREMENT SENSORS
- STATIC ELECTRICITY PREVENTION DEVICES
- LASER MARKERS
- PLC
- HUMAN MACHINE INTERFACES
- ENERGY CONSUMPTION VISUALIZATION COMPONENTS
- FA COMPONENTS
- MACHINE VISION SYSTEMS
- UV CURING SYSTEMS

### Teaching with ON / OFF keys SET mode

Simply press the ON key when an object is present, and OFF when it is not, and teaching is completed. There is no need to consider difference between Light-ON and Dark-ON.

#### <Setting example>

Thru-beam type / Retroreflective type

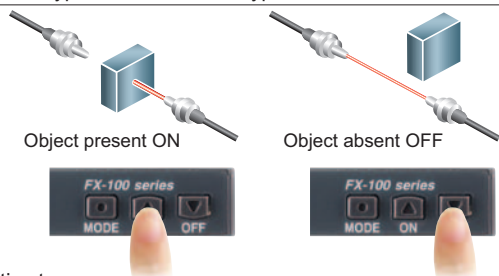

Reflective type

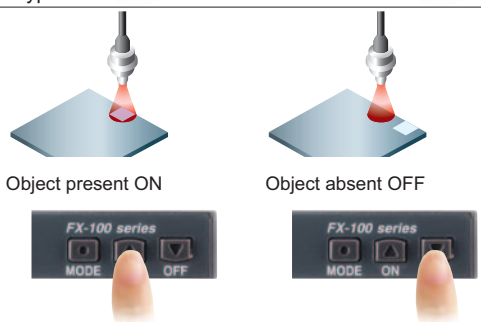

### Teaching even without an object — Limit teaching function

Threshold value can be set by performing teaching only when an object is absent (when the incident light amount is stable). This is useful when there are other objects in the background also when defecting a minute objects. Teaching can also be carried out using external input.

### Threshold value follow-up cycle setting function PRO mode

This function performs automatic setting to threshold value by checking the incident light intensity at desired intervals in order to follow the changes in the light amount resulting from changes in the environment over long periods (such as dust). Contributes to reduction in maintenance hours.

\* Effective when the output operation is set to Dark-ON, and when using thru-beam type or retroreflective type fibers.

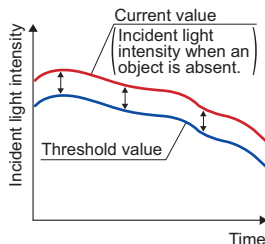

### Resolves variation in incident light intensity display **GETA function** PRO mode

Even when performing the same sensing operation, there may be variances in the digital values of the fiber amp. There is no problem with the sensor itself, but the operator may find it troubling. Given value can be corrected with the GETA function, so the apparent variation can be eliminated and the creation of operation manuals can proceed smoothly.

#### Variations in the amount of light received



Unify at 500 using the GETA function

#### Example of current incident light intensity display of '500' is adjusted to '1000'

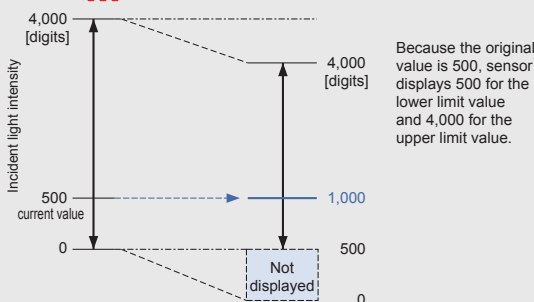

### Emission amount setting function SET mode

Emission amount can be reduced in order to achieve stable detection when the receiving light level is saturated, such as detection at close range and detection of transparent or minute objects. Previously, the emission amount level was only one, but from production in December 2007, four level setting (three level + auto setting) has become available. This function brings easier settings than before.

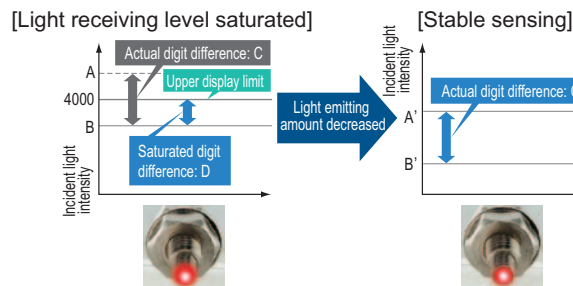

- Selection Guide
- Fibers
- Fiber Amplifiers
- FX-500
- FX-100
- FX-300
- FX-410
- FX-311
- FX-301-F7/ FX-301-F

### Emission frequency setting mode **SET mode**

Mutual interference is prevented for max. 3 units for standard type **FX-101** and max. 4 units in case of long sensing range type **FX-102**. During setting of interference prevention, emitter and output indicator both flash, so it is convenient to confirm which fiber is in the setting process at a glance. Emitter flashes even when an amplifier is not installed close together.

\* When the emission frequency is changed, a response time is also changed.

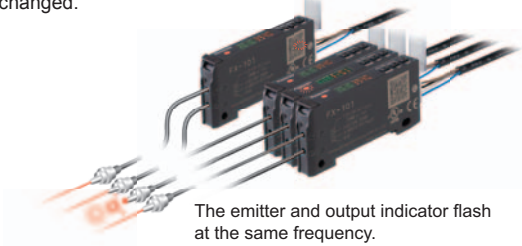

### External input setting mode **PRO mode**

External input can be selected from emission halt, limit teaching / full-auto teaching / 2-level teaching, ECO or emission amount test. Threshold value set at each teaching is also memorized.

\* 2-level teaching, emission amount test and threshold value storing setting are available in amplifiers manufactured after December 2007.

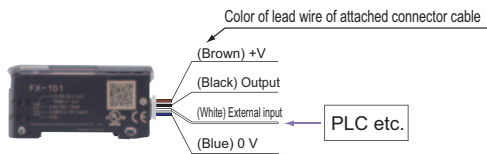

External input lines are equipped as standard

### Digital display inversion setting **PRO mode**

The viewing orientation of the digital display can be inverted in accordance with the setting direction of the amplifier.



### Alert function **PRO mode**

When the amount light received approaches the threshold value, the display can be made to blink in order to alert the operator.

**<When using at a shift amount of 20% and a threshold value of 1,000>**

The amount of light received ranges from about 900 to 1,100 when the digital indicator flashes.

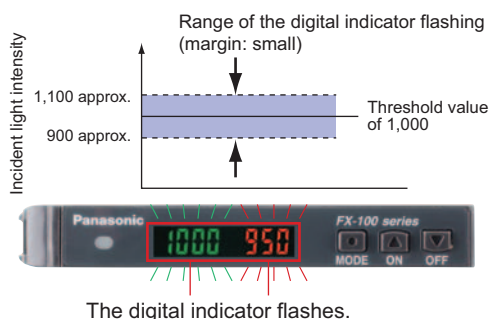

### Setting copy function to reduce man-hours and human error **PRO mode**

By connecting a fiber sensor to the master fiber sensor, the master sensor settings can be copied along with data communications. When the same settings are input to several units, trouble from setting errors can be prevented, also changes to the work order will be small when equipment design is changed.

#### <Wiring to copy settings>

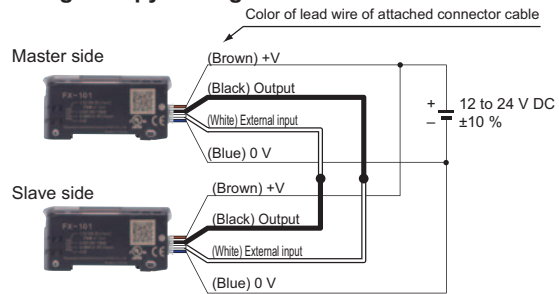

#### These settings can be copied

Threshold value, output operation, timer operation, timer emission amount, shift, external input, threshold value-storing, ECO inverting digital display, and threshold value margin

### Without mounting bracket

Selectable either mounting on DIN rail or direct mounting with through hole. Direct mounting brings stability even on a movable parts or installation of a single unit.

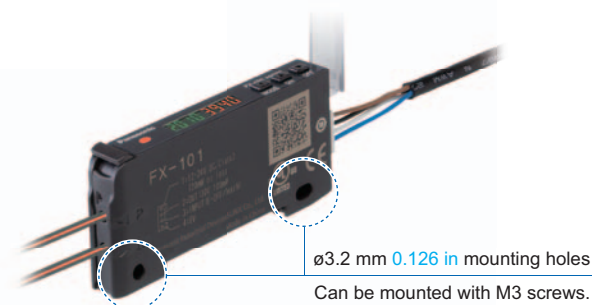

### Available from standard type or long sensing range type

Standard type and long sensing range type are available which has various response time and sensing range. The model best meet application needs can be selected.

Model No.	Type	Sensing range (FT-43)	Response time
<b>FX-101</b>	Standard type	350 mm 13.780 in	Max. 250 μs
<b>FX-102</b>	Long sensing range type	970 mm 38.189 in	Max. 2.5 ms

### Power consumption saving with **ECO mode**

When there is no key operations in approximately 20 seconds, digital display turns off and power consumption can be reduced to 600mW or less (720mW in normal mode).

#### FIBER SENSORS

#### LASER SENSORS

#### PHOTOELECTRIC SENSORS

#### MICRO PHOTOELECTRIC SENSORS

#### AREA SENSORS

#### LIGHT CURTAINS / SAFETY COMPONENTS

#### PRESSURE / FLOW SENSORS

#### INDUCTIVE PROXIMITY SENSORS

#### PARTICULAR USE SENSORS

#### SENSOR OPTIONS

#### SIMPLE WIRE-SAVING UNITS

#### WIRE-SAVING SYSTEMS

#### MEASUREMENT SENSORS

#### STATIC ELECTRICITY PREVENTION DEVICES

#### LASER MARKERS

#### PLC

#### HUMAN MACHINE INTERFACES

#### ENERGY CONSUMPTION VISUALIZATION COMPONENTS

#### FA COMPONENTS

#### MACHINE VISION SYSTEMS

#### UV CURING SYSTEMS

#### Selection Guide

#### Fibers

#### Fiber Amplifiers

#### FX-500

#### FX-100

#### FX-300



#### FX-410

#### FX-311

#### FX-301-F7 / FX-301-F

**ORDER GUIDE**

**Amplifiers**

Type	Appearance	Model No.	Emitting element	Output
Standard type		<b>FX-101</b> (Note 2)	Red LED	NPN open-collector transistor
		<b>FX-101-Z</b> (Note 3)		NPN open-collector transistor
		<b>FX-101P</b> (Note 2)		PNP open-collector transistor
		<b>FX-101P-Z</b> (Note 3)		PNP open-collector transistor
		<b>FX-101-CC2</b>		NPN open-collector transistor
Long sensing range type		<b>FX-101P-CC2</b>		PNP open-collector collector transistor
		<b>FX-102</b> (Note 2)		NPN open-collector transistor
		<b>FX-102-Z</b> (Note 3)		NPN open-collector transistor
		<b>FX-102P</b> (Note 2)		PNP open-collector transistor
		<b>FX-102P-Z</b> (Note 3)		PNP open-collector transistor
		<b>FX-102-CC2</b>	NPN open-collector transistor	
		<b>FX-102P-CC2</b>	PNP open-collector transistor	

**Accessory**

- **CN-14A-C2**  
(Connector attached cable 2 m 6.562 ft)  
\* Only include cable set type



- **FC-FX-1** (Protection cover)  
\* It have been attached from the production at July, 2011.

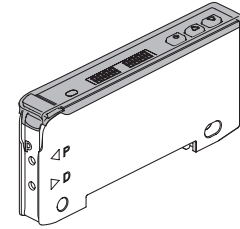

Notes: 1) The connector attached cable 2 m 6.562 ft **CN-14A-C2** is supplied with the amplifier.  
 2) Make sure to use the optional connector attached cable **CN-14A(-R)-C□** or the connector **CN-14A**, or a connector manufactured by J.S.T. Mfg. Co., Ltd. (contact: SPHD-001T-P0.5, housing: PAP-04V-S)  
 3) Make sure to use the optional M8 connector attached cable **CN-24A-C□**.

**OPTIONS**

Designation	Model No.	Description
Connector attached cable	<b>CN-14A-C1</b>	1 m 3.281 ft
	<b>CN-14A-C2</b> (Note)	2 m 6.562 ft
	<b>CN-14A-C3</b>	3 m 9.843 ft
	<b>CN-14A-C5</b>	5 m 16.404 ft
	<b>CN-14A-R-C1</b>	1 m 3.281 ft
Connector attached cable (Flexible type)	<b>CN-14A-R-C2</b>	2 m 6.562 ft
	<b>CN-14A-R-C3</b>	3 m 9.843 ft
	<b>CN-14A-R-C5</b>	5 m 16.404 ft
	M8 connector attached cable	<b>CN-24A-C2</b>
<b>CN-24A-C5</b>		5 m 16.404 ft
Connector	<b>CN-14A</b>	Set of 10 housings and 40 contacts
Amplifier mounting bracket	<b>MS-DIN-4</b>	Mounting bracket for amplifier
End plates	<b>MS-DIN-E</b>	When it moves depending on the way it is installed on a DIN rail, these end plates ensure that all amplifiers are mounted together in a secure and fully connected manner.

Note: The connector attached cable **CN-14A-C2** is supplied with the cable set type **FX-10□-CC2**.

**M8 connector attached cable**

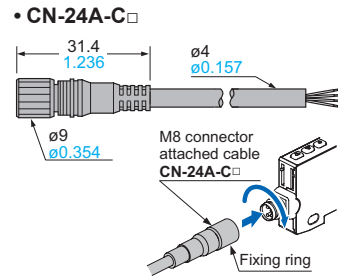

**Amplifier mounting bracket**

- **MS-DIN-4**

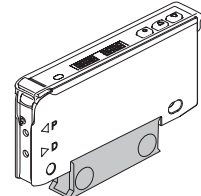

**Connector attached cable**

- **CN-14A(-R)-C□**

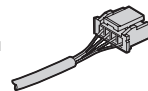

**Connector**

- **CN-14A**

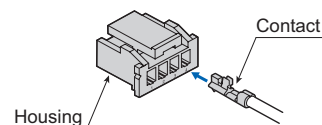

FIBER SENSORS  
 LASER SENSORS  
 PHOTO-ELECTRIC SENSORS  
 MICRO PHOTO-ELECTRIC SENSORS  
 AREA SENSORS  
 LIGHT CURTAINS / SAFETY COMPONENTS  
 PRESSURE / FLOW SENSORS  
 INDUCTIVE PROXIMITY SENSORS  
 PARTICULAR USE SENSORS  
 SENSOR OPTIONS  
 SIMPLE WIRE-SAVING UNITS  
 WIRE-SAVING SYSTEMS  
 MEASUREMENT SENSORS  
 STATIC ELECTRICITY PREVENTION DEVICES  
 LASER MARKERS  
 PLC  
 HUMAN MACHINE INTERFACES  
 ENERGY CONSUMPTION VISUALIZATION COMPONENTS  
 FA COMPONENTS  
 MACHINE VISION SYSTEMS  
 UV CURING SYSTEMS  
 Selection Guide  
 Fibers  
 Fiber Amplifiers  
**FX-500**  
**FX-100**  
**FX-300**  
**FX-410**  
**FX-311**  
 FX-301-F7/  
 FX-301-F

## LIST OF FIBERS

### Thru-beam type (one pair set)



Fibers are listed in alphabetic order. Refer to p.5~ "Fiber Selection" for details of each fiber.

Model No.	Sensing range (mm in) (Note 1)		Type / Ambient temperature	Fiber cable length ✂: Free-cut	Dimensions
	Standard type <b>FX-101</b> □	Long sensing range type <b>FX-102</b> □			
<b>FT-140</b>	14,000 <b>551.180</b>	19,600 <b>771.652</b> (Note 2)	Threaded, M14, Long sensing range, -40 to +70 °C <b>-40 to 158 °F</b>	✂ 10 m <b>32.808 ft</b>	P.51
<b>FT-30</b>	135 <b>5.315</b>	400 <b>15.748</b>	Super quality, Threaded, M3, -55 to +80 °C <b>-67 to 176 °F</b>	2 m <b>6.562 ft</b>	P.51
<b>FT-31</b>	130 <b>5.118</b>	340 <b>13.386</b>	Threaded, M3, -55 to +80 °C <b>-67 to 176 °F</b>	✂ 2 m <b>6.562 ft</b>	P.51
<b>FT-31S</b>	130 <b>5.118</b>	340 <b>13.386</b>	Sleeve, Threaded, M3, -55 to +80 °C <b>-67 to 176 °F</b>		P.51
<b>FT-31W</b>	80 <b>3.150</b>	240 <b>9.449</b>	Threaded, M3, -40 to +60 °C <b>-40 to 140 °F</b>	2 m <b>6.562 ft</b>	P.51
<b>FT-40</b>	320 <b>12.598</b>	870 <b>34.252</b>	Super quality, Threaded, M4, -55 to +80 °C <b>-67 to 176 °F</b>		P.51
<b>FT-42</b>	300 <b>11.811</b>	800 <b>31.496</b>	Threaded, M4, -55 to +80 °C <b>-67 to 176 °F</b>	✂ 2 m <b>6.562 ft</b>	P.51
<b>FT-42S</b>	300 <b>11.811</b>	800 <b>31.496</b>	Sleeve, Threaded, M4, -55 to +80 °C <b>-67 to 176 °F</b>		P.51
<b>FT-42W</b>	260 <b>10.236</b>	720 <b>28.346</b>	Threaded, M4, -40 to +60 °C <b>-40 to 140 °F</b>	P.51	P.51
<b>FT-43</b>	350 <b>13.780</b>	970 <b>38.189</b>	Threaded, M4, -55 to +80 °C <b>-67 to 176 °F</b>		P.51
<b>FT-45X</b>	340 <b>13.386</b>	920 <b>36.220</b>	Threaded, M4, -55 to +80 °C <b>-67 to 176 °F</b>	1 m <b>3.281 ft</b>	P.52
<b>FT-A11</b>	1,900 <b>74.803</b>	3,600 <b>141.732</b> (Note 2)	Wide beam, -40 to +70 °C <b>-40 to 158 °F</b>	✂ 2 m <b>6.562 ft</b>	P.52
<b>FT-A11W</b>	1,700 <b>66.929</b>	3,400 <b>133.858</b>	Wide beam, -40 to +55 °C <b>-40 to 131 °F</b>		P.52
<b>FT-A32</b>	3,600 <b>141.732</b> (Note 2)	3,600 <b>141.732</b> (Note 2)	Wide beam, -40 to +60 °C <b>-40 to 140 °F</b>	P.52	P.52
<b>FT-A32W</b>	3,600 <b>141.732</b> (Note 2)	3,600 <b>141.732</b> (Note 2)	Wide beam, -40 to +55 °C <b>-40 to 131 °F</b>		P.52
<b>FT-AL05</b>	250 <b>9.843</b>	660 <b>25.984</b>	Wide beam, -55 to +80 °C <b>-67 to 176 °F</b>	✂ 1 m <b>3.281 ft</b>	P.52
<b>FT-E13</b>	6 <b>0.236</b>	19 <b>0.748</b>	Cylindrical, Ultra-small dia., ø3 <b>0.118</b> , -40 to +70 °C <b>-40 to 158 °F</b>		P.52
<b>FT-E23</b>	22 <b>0.866</b>	80 <b>3.150</b>	Cylindrical, Ultra-small dia., ø3 <b>0.118</b> , -40 to +70 °C <b>-40 to 158 °F</b>	✂ 2 m <b>6.562 ft</b>	P.52
<b>FT-H13-FM2</b>	250 <b>9.843</b>	700 <b>27.559</b>	Heat-resistant, -60 to +130 °C <b>-76 to 266 °F</b>		P.52
<b>FT-H20-J20-S</b> (Note 3)	135 <b>5.315</b>	420 <b>16.535</b>	Heat-resistant (joint), -60 to +200 °C <b>-76 to 392 °F</b>	✂ 200 mm <b>7.874 in</b> (Note 4)	P.53
<b>FT-H20-J30-S</b> (Note 3)	135 <b>5.315</b>	420 <b>16.535</b>	Heat-resistant (joint), -60 to +200 °C <b>-76 to 392 °F</b>	✂ 300 mm <b>11.811 in</b> (Note 4)	P.53
<b>FT-H20-J50-S</b> (Note 3)	135 <b>5.315</b>	420 <b>16.535</b>	Heat-resistant (joint), -60 to +200 °C <b>-76 to 392 °F</b>	✂ 500 mm <b>19.685 in</b> (Note 4)	P.53
<b>FT-H20-M1</b>	210 <b>8.268</b>	540 <b>21.260</b>	Heat-resistant, -60 to +200 °C <b>-76 to 392 °F</b>	1 m <b>3.281 ft</b>	P.53
<b>FT-H20-VJ50-S</b> (Note 3)	150 <b>5.906</b>	500 <b>19.685</b>	Heat-resistant (joint), -60 to +200 °C <b>-76 to 392 °F</b>	✂ 500 mm <b>19.685 in</b> (Note 4)	P.53
<b>FT-H20-VJ80-S</b> (Note 3)	150 <b>5.906</b>	500 <b>19.685</b>	Heat-resistant (joint), -60 to +200 °C <b>-76 to 392 °F</b>	✂ 800 mm <b>31.496 in</b> (Note 4)	P.53
<b>FT-H20W-M1</b>	100 <b>3.937</b>	300 <b>11.811</b>	Heat-resistant, -60 to +200 °C <b>-76 to 392 °F</b>	1 m <b>3.281 ft</b>	P.53
<b>FT-H30-M1V-S</b> (Note 5)	110 <b>4.331</b>	280 <b>11.024</b>	Vacuum-resistant, -30 to +300 °C <b>-22 to 572 °F</b>		P.53
<b>FT-H35-M2</b>	170 <b>6.693</b>	490 <b>19.291</b>	Heat-resistant, -60 to +350 °C <b>-76 to 572 °F</b>	2 m <b>6.562 ft</b>	P.53
<b>FT-H35-M2S6</b>	170 <b>6.693</b>	490 <b>19.291</b>	Heat-resistant, -60 to +350 °C <b>-76 to 572 °F</b>		P.53
<b>FT-HL80Y</b>	990 <b>38.976</b>	2,340 <b>92.126</b>	Chemical-resistant, Metal-free, -40 to +115 °C <b>-76 to 239 °F</b>	✂ 2 m <b>6.562 ft</b> (Note 6)	P.53

Notes: 1) Note that the sensing range of the free-cut type fiber may be reduced by 20 % max. depending upon how the fiber is cut.

2) The fiber cable length practically limits the sensing range.

3) Heat-resistant joint fibers and ordinary-temperature fibers (**FT-42**) are sold as a set.

4) This is the fiber length (fixed length) for heat-resistant fibers. The ordinary-temperature fibers are free-cut to 2 m **6.562 ft**.

5) Sold as a set comprising vacuum type fiber + photo-terminal (**FV-BR1**) + fiber at atmospheric side (**FT-J8**).

6) The allowable cutting range is 500 mm **19.685 in** from the end that the amplifier inserted.

FIBER  
SENSORSLASER  
SENSORSPHOTO-  
ELECTRIC  
SENSORSMICRO  
PHOTO-  
ELECTRIC  
SENSORSAREA  
SENSORSLIGHT  
CURTAINS /  
SAFETY  
COMPONENTSPRESSURE /  
FLOW  
SENSORSINDUCTIVE  
PROXIMITY  
SENSORSPARTICULAR  
USE  
SENSORSSENSOR  
OPTIONSSIMPLE  
WIRE-SAVING  
UNITSWIRE-SAVING  
SYSTEMSMEASURE-  
MENT  
SENSORSSTATIC  
ELECTRICITY  
PREVENTION  
DEVICESLASER  
MARKERS

PLC

HUMAN  
MACHINE  
INTERFACESENERGY  
CONSUMPTION  
VISUALIZATION  
COMPONENTSFA  
COMPONENTSMACHINE  
VISION  
SYSTEMSUV  
CURING  
SYSTEMSSelection  
Guide

Fibers

Fiber  
Amplifiers**FX-500****FX-100****FX-300****FX-410****FX-311**FX-301-F/  
FX-301-F

**LIST OF FIBERS**

**Thru-beam type (one pair set)**



Fibers are listed in alphabetic order. Refer to p.5~ "Fiber Selection" for details of each fiber.

Model No.	Sensing range (mm in) (Note 1)		Type / Ambient temperature	Fiber cable length ✂️: Free-cut	Dimensions	
	Standard type <b>FX-101</b> □	Long sensing range type <b>FX-102</b> □				
<b>FT-KS40</b>	2,200 86.614	3,600 141.732 (Note 2)	Narrow Beam, -40 to +60 °C -40 to 140 °F	✂️ 2 m 6.562 ft	P.54	
<b>FT-KV26</b>	135 5.315	560 22.047	Narrow Beam, Side-view, -40 to +60 °C -40 to 140 °F		P.54	
<b>FT-KV40</b>	2,200 86.614	3,600 141.732 (Note 2)	Narrow Beam, Side-view, -40 to +60 °C -40 to 140 °F		P.54	
<b>FT-KV40W</b>	2,200 86.614	3,600 141.732 (Note 2)	Narrow Beam, Side-view, -40 to +60 °C -40 to 140 °F	✂️ 2 m 6.562 ft	P.54	
<b>FT-L80Y</b>	1,100 43.307	2,600 102.362	Chemical-resistant, Metal-free, -40 to +70 °C -40 to 158 °F	✂️ 2 m 6.562 ft (Note 3)	P.54	
<b>FT-R31</b>	100 3.937	340 13.386	Square head, M3, -55 to +80 °C -67 to 176 °F	✂️ 2 m 6.562 ft	P.54	
<b>FT-R40</b>	270 10.630	740 29.134	Threaded, M4, Elbow, -55 to +80 °C -67 to 176 °F		P.54	
<b>FT-R41W</b>	250 9.843	710 27.953	Square head, M4, -40 to +60 °C -40 to 140 °F		P.54	
<b>FT-R42W</b>	510 20.079	2,000 78.740	Square head, M4, -40 to +60 °C -40 to 140 °F		P.54	
<b>FT-R43</b>	210 8.268	640 25.197	Square head, M4, -55 to +80 °C -67 to 176 °F		P.54	
<b>FT-R44Y</b>	210 8.268	640 25.197	Oil-resistant, Square head, M4, Cable-protection type, -55 to +80 °C -67 to 176 °F		P.55	
<b>FT-R60Y</b>	690 27.165	1,890 74.409	Oil-resistant, Square head, M6, Full-protection type, -55 to +80 °C -67 to 176 °F		P.55	
<b>FT-S11</b>	40 1.575	90 3.543	Cylindrical, φ1 0.039, -55 to +80 °C -67 to 176 °F		500 mm 19.685 in	P.55
<b>FT-S20</b>	135 5.315	400 15.748	Super quality, Cylindrical, φ1.5 0.059, -55 to +80 °C -67 to 176 °F		2 m 6.562 ft	P.55
<b>FT-S21</b>	130 5.118	340 13.386	Cylindrical, φ1.5 0.059, -55 to +80 °C -67 to 176 °F		✂️ 2 m 6.562 ft	P.55
<b>FT-S21W</b>	80 3.150	240 9.449	Cylindrical, φ1.5 0.059, -40 to +60 °C -40 to 140 °F	P.55		
<b>FT-S30</b>	320 12.598	870 34.252	Super quality, Cylindrical, φ3 0.118, -55 to +80 °C -67 to 176 °F	2 m 6.562 ft	P.55	
<b>FT-S31W</b>	260 10.236	720 28.346	Cylindrical, φ3 0.118, -40 to +60 °C -40 to 140 °F	✂️ 2 m 6.562 ft	P.55	
<b>FT-S32</b>	1,100 43.307	3,000 118.110	Cylindrical, φ2.5 0.098, -40 to +70 °C -40 to 158 °F		P.55	
<b>FT-V23</b>	160 6.299	400 15.748	Sleeve, Cylindrical, Side-view, φ2 0.079, -55 to +80 °C -67 to 176 °F		P.55	
<b>FT-V24W</b>	35 1.378	90 3.543	Sleeve, Cylindrical, Side-view, φ2 0.079, -40 to +60 °C -40 to 140 °F		P.56	
<b>FT-V25</b>	95 3.740	260 10.236	Sleeve, Cylindrical, Side-view, φ2 0.079, -55 to +80 °C -67 to 176 °F		P.56	
<b>FT-V30</b>	180 7.087	480 18.898	Sleeve, Cylindrical, Side-view, φ2.5 0.098, -55 to +80 °C -67 to 176 °F		P.56	
<b>FT-V40</b>	1,000 39.370	3,100 122.047	Cylindrical, Side-view, φ4 0.157, -40 to +60 °C -40 to 140 °F		P.56	
<b>FT-V80Y</b>	340 13.386	800 31.496	Chemical-resistant, Metal-free -40 to +70 °C -40 to 158 °F		✂️ 2 m 6.562 ft (Note 3)	P.56
<b>FT-Z20HBW</b>	100 3.937	320 12.598	Flat with boss, -40 to +60 °C -40 to 140 °F		✂️ 1 m 3.281 ft	P.56
<b>FT-Z20W</b>	280 11.024	730 28.740	Flat with boss, -40 to +60 °C -40 to 140 °F			P.56
<b>FT-Z30</b>	710 27.953	2,300 90.551	Flat, -40 to +60 °C -40 to 140 °F	✂️ 2 m 6.562 ft	P.56	
<b>FT-Z30E</b>	1,200 47.244	3,200 125.984	Flat, -40 to +60 °C -40 to 140 °F		P.56	
<b>FT-Z30EW</b>	1,400 55.118	2,600 102.362	Flat, -40 to +60 °C -40 to 140 °F		P.57	
<b>FT-Z30H</b>	1,400 55.118	3,200 125.984	Flat, -40 to +60 °C -40 to 140 °F		P.57	
<b>FT-Z30HW</b>	1,400 55.118	3,200 125.984	Flat, -40 to +60 °C -40 to 140 °F		P.57	
<b>FT-Z30W</b>	540 21.260	1,800 70.866	Flat, -40 to +60 °C -40 to 140 °F		P.57	
<b>FT-Z40HBW</b>	260 10.236	720 28.346	Flat with boss, -40 to +60 °C -40 to 140 °F		P.57	
<b>FT-Z40W</b>	410 16.142	1,200 47.244	Flat with boss, -40 to +60 °C -40 to 140 °F		P.57	
<b>FT-Z802Y</b>	520 20.472	3,100 122.047	Chemical-resistant, 0 to +60 °C 32 to 140 °F		P.57	

Notes: 1) Note that the sensing range of the free-cut type fiber may be reduced by 20 % max. depending upon how the fiber is cut.  
 2) The fiber cable length practically limits the sensing range.  
 3) The allowable cutting range is 500 mm 19.685 in from the end that the amplifier inserted.

FIBER SENSORS  
 LASER SENSORS  
 PHOTO-ELECTRIC SENSORS  
 MICRO PHOTO-ELECTRIC SENSORS  
 AREA SENSORS  
 LIGHT CURTAINS / SAFETY COMPONENTS  
 PRESSURE / FLOW SENSORS  
 INDUCTIVE PROXIMITY SENSORS  
 PARTICULAR USE SENSORS  
 SENSOR OPTIONS  
 SIMPLE WIRE-SAVING UNITS  
 WIRE-SAVING SYSTEMS  
 MEASUREMENT SENSORS  
 STATIC ELECTRICITY PREVENTION DEVICES  
 LASER MARKERS  
 PLC  
 HUMAN MACHINE INTERFACES  
 ENERGY CONSUMPTION VISUALIZATION COMPONENTS  
 FA COMPONENTS  
 MACHINE VISION SYSTEMS  
 UV CURING SYSTEMS  
 Selection Guide  
 Fibers  
 Fiber Amplifiers  
**FX-500**  
**FX-100**  
**FX-300**  
**FX-410**  
**FX-311**  
 FX-301-F7/  
 FX-301-F

**LIST OF FIBERS**

**Retroreflective type** 

Fibers are listed in alphabetic order. Refer to p.5~ "Fiber Selection" for details of each fiber.

Model No.	Sensing range (mm in) (Note 1) (Note 2)		Type / Ambient temperature	Fiber cable length ✂: Free-cut	Dimensions
	Standard type <b>FX-101</b> □	Long sensing range type <b>FX-102</b> □			
<b>FR-KZ22E</b>	15 to 200 <b>0.591 to 7.874</b>	15 to 360 <b>0.591 to 14.173</b>	Wafer mapping, -40 to +60 °C <b>-40 to 140 °F</b>	✂ 2 m <b>6.562 ft</b>	P.58
<b>FR-KZ50E</b>	20 to 200 <b>0.787 to 7.874</b>	20 to 350 <b>0.787 to 13.780</b>	Narrow Beam, Side sensing, -40 to +60 °C <b>-40 to 140 °F</b>		P.58
<b>FR-KZ50H</b>	20 to 200 <b>0.787 to 7.874</b>	20 to 350 <b>0.787 to 13.780</b>	Narrow Beam, Top sensing, -40 to +60 °C <b>-40 to 140 °F</b>		P.58
<b>FR-Z50HW</b>	100 to 550 <b>3.937 to 21.654</b>	100 to 830 <b>3.937 to 32.677</b>	With polarizing filter, -25 to +55 °C <b>-13 to 131 °F</b>		P.58

Notes: 1) Note that the sensing range of the free-cut type fiber may be reduced by 20 % max. depending upon how the fiber is cut. The sensing range of **FR-KZ22E** is specified for the attached reflector. The sensing range of **FR-KZ50E** and **FR-KZ50H** is specified for the attached reflector **RF-003**. The sensing range of **FR-Z50HW** is specified for the **RF-13**.

2) The sensing range is the possible setting range for the attached reflector. The fiber can detect an object less than setting range for the reflector. However, note that if there are any white or highly-reflective surfaces near the fiber head, reflected incident light may affect the fiber head. If this occurs, adjust the threshold value of the amplifier unit before use.

**Reflective type** 

Fibers are listed in alphabetic order. Refer to p.5~ "Fiber Selection" for details of each fiber.

Model No.	Sensing range (mm in) (Note 1) (Note 2) / Description		Type / Ambient temperature	Fiber cable length ✂: Free-cut	Dimensions	
	Standard type <b>FX-101</b> □	Long sensing range type <b>FX-102</b> □				
<b>FD-30</b>	45 <b>1.772</b>	155 <b>6.102</b>	Super quality, Threaded, M3, -55 to +80 °C <b>-67 to 176 °F</b>	2 m <b>6.562 ft</b>	P.59	
<b>FD-31</b>	35 <b>1.378</b>	140 <b>5.512</b>	Threaded, M3, -55 to +80 °C <b>-67 to 176 °F</b>	✂ 2 m <b>6.562 ft</b>	P.59	
<b>FD-31W</b>	15 <b>0.591</b>	60 <b>2.362</b>	Threaded, M3, -40 to +60 °C <b>-40 to 140 °F</b>		P.59	
<b>FD-32G</b>	70 <b>2.756</b>	190 <b>7.480</b>	Threaded, M3, -55 to +80 °C <b>-67 to 176 °F</b>		P.59	
<b>FD-32GX</b>	75 <b>2.953</b>	210 <b>8.268</b>	Threaded, M3, -55 to +80 °C <b>-67 to 176 °F</b>	✂ 1 m <b>3.281 ft</b> (Note 3)	P.59	
<b>FD-40</b>	45 <b>1.772</b>	155 <b>6.102</b>	Super quality, Threaded, M4, -55 to +80 °C <b>-67 to 176 °F</b>	2 m <b>6.562 ft</b>	P.59	
<b>FD-41</b>	35 <b>1.378</b>	140 <b>5.512</b>	Threaded, M4, -55 to +80 °C <b>-67 to 176 °F</b>	✂ 2 m <b>6.562 ft</b>	P.59	
<b>FD-41S</b>	35 <b>1.378</b>	140 <b>5.512</b>	Sleeve, Threaded, M4, -55 to +80 °C <b>-67 to 176 °F</b>		P.59	
<b>FD-41SW</b>	15 <b>0.591</b>	60 <b>2.362</b>	Sleeve, Threaded, M4, -40 to +60 °C <b>-40 to 140 °F</b>		P.59	
<b>FD-41W</b>	80 <b>3.150</b>	230 <b>9.055</b>	Threaded, M4, -40 to +60 °C <b>-40 to 140 °F</b>		P.59	
<b>FD-42G</b>	70 <b>2.756</b>	190 <b>7.480</b>	Threaded, M4, -55 to +80 °C <b>-67 to 176 °F</b>		P.60	
<b>FD-42GW</b>	45 <b>1.772</b>	140 <b>5.512</b>	Threaded, M4, -40 to +60 °C <b>-40 to 140 °F</b>		P.60	
<b>FD-60</b>	140 <b>5.512</b>	420 <b>16.535</b>	Super quality, Threaded, M6, -55 to +80 °C <b>-67 to 176 °F</b>		2 m <b>6.562 ft</b>	P.60
<b>FD-61</b>	120 <b>4.724</b>	410 <b>16.142</b>	Threaded, M6, -55 to +80 °C <b>-67 to 176 °F</b>		✂ 2 m <b>6.562 ft</b>	P.60
<b>FD-61G</b>	120 <b>4.724</b>	350 <b>13.780</b>	Threaded, M6, -55 to +80 °C <b>-67 to 176 °F</b>			P.60
<b>FD-61S</b>	130 <b>5.118</b>	360 <b>14.173</b>	Sleeve, Threaded, M6, -55 to +80 °C <b>-67 to 176 °F</b>			P.60
<b>FD-61W</b>	80 <b>3.150</b>	230 <b>9.055</b>	Threaded, M6, -40 to +60 °C <b>-40 to 140 °F</b>	P.60		
<b>FD-62</b>	170 <b>6.693</b>	450 <b>17.717</b>	Threaded, M6, -55 to +80 °C <b>-67 to 176 °F</b>	P.60		
<b>FD-64X</b>	75 <b>2.953</b>	220 <b>8.661</b>	Threaded, M6, -55 to +80 °C <b>-67 to 176 °F</b>	1 m <b>3.281 ft</b>	P.61	
<b>FD-A16</b>	120 <b>4.724</b>	240 <b>9.449</b>	Wide beam, -40 to +60 °C <b>-40 to 140 °F</b>	✂ 2 m <b>6.562 ft</b>	P.61	
<b>FD-AL11</b>	100 <b>3.937</b>	285 <b>11.220</b>	Array, -55 to +80 °C <b>-67 to 176 °F</b>		P.61	
<b>FD-E13</b>	5 <b>0.197</b>	15 <b>0.591</b>	Cylindrical, Ultra-small dia., ø1.5 <b>0.059</b> , -40 to +60 °C <b>-40 to 140 °F</b>	1 m <b>3.281 ft</b>	P.61	
<b>FD-E23</b>	20 <b>0.787</b>	70 <b>2.756</b>	Cylindrical, Ultra-small dia., ø3 <b>0.118</b> , -40 to +70 °C <b>-40 to 158 °F</b>	P.61		
<b>FD-EG30</b>	20 <b>0.787</b>	70 <b>2.756</b>	Threaded, M3, Ultra-small dia., -40 to +70 °C <b>-40 to 158 °F</b>	500 mm <b>19.685 in</b>	P.61	
<b>FD-EG30S</b>	20 <b>0.787</b>	70 <b>2.756</b>	Sleeve, Threaded, Ultra-small dia., M3, -40 to +70 °C <b>-40 to 158 °F</b>	1 m <b>3.281 ft</b>	P.62	
<b>FD-EG31</b>	7 <b>0.276</b>	25 <b>0.984</b>	Threaded, M3, Ultra-small dia., -20 to +60 °C <b>-4 to 140 °F</b>	500 mm <b>19.685 in</b>	P.62	
<b>FD-F4</b>	Applicable pipe diameter: Outer dia. ø6 to ø26 mm <b>ø0.236 to ø1.024 in</b> transparent pipe [PFA (fluorine resin) or equivalently transparent pipe, wall thickness 1 mm <b>0.039 in</b> ] Liquid absent: Beam received, Liquid present: Beam interrupted		Pipe-mountable type, Liquid level sensing, -40 to +100 °C <b>-40 to 212 °F</b>	✂ 2 m <b>6.562 ft</b>	P.62	
<b>FD-F41</b>	Applicable pipe diameter: Outer dia. ø6 to ø26 mm <b>ø0.236 to ø1.024 in</b> transparent pipe [PVC (vinyl chloride), fluorine resin, polycarbonate, acrylic, glass, wall thickness 1 to 3 mm <b>0.039 to 0.118 in</b> ] Liquid absent: Beam received, Liquid present: Beam interrupted		Pipe-mountable type, Liquid level sensing, -40 to +100 °C <b>-40 to 212 °F</b>		P.62	

Notes: 1) Note that the sensing range of the free-cut type fiber may be reduced by 20 % max. depending upon how the fiber is cut.

2) The sensing range is specified for white non-glossy paper.

3) The allowable cutting range is 500 mm **19.685 in** from the end that the amplifier inserted.

FIBER SENSORS

LASER SENSORS

PHOTO-ELECTRIC SENSORS

MICRO PHOTO-ELECTRIC SENSORS

AREA SENSORS

LIGHT CURTAINS / SAFETY COMPONENTS

PRESSURE / FLOW SENSORS

INDUCTIVE PROXIMITY SENSORS

PARTICULAR USE SENSORS

SENSOR OPTIONS

SIMPLE WIRE-SAVING UNITS

WIRE-SAVING SYSTEMS

MEASUREMENT SENSORS

STATIC ELECTRICITY PREVENTION DEVICES

LASER MARKERS

PLC

HUMAN MACHINE INTERFACES

ENERGY CONSUMPTION VISUALIZATION COMPONENTS

FA COMPONENTS

MACHINE VISION SYSTEMS

UV CURING SYSTEMS

Selection Guide

Fibers

Fiber Amplifiers

**FX-500**

**FX-100**

**FX-300**

**FX-410**

**FX-311**

**FX-301-F7 / FX-301-F**



**LIST OF FIBERS**

**Reflective type**



Fibers are listed in alphabetic order. Refer to p.5~ "Fiber Selection" for details of each fiber.

Model No.	Sensing range (mm in) (Note 1) (Note 2) / Description		Type / Ambient temperature	Fiber cable length ✂️ Free-cut	Dimensions
	Standard type <b>FX-101</b> □	Long sensing range type <b>FX-102</b> □			
<b>FD-F41Y</b> (Note 3)	ø4 mm <b>ø0.157 in</b> Protective tube: Fluorine resin, length 500 mm <b>19.685 in</b> (cuttable) Liquid surface not contacted: Beam received, Liquid surface contacted: Beam interrupted		Contact type, Liquid level sensing, Metal-free, -40 to +70 °C <b>-40 to 158 °F</b>	✂️ 2 m <b>6.562 ft</b>	P.62
<b>FD-F8Y</b>	ø6 mm <b>ø0.236 in</b> Protective tube: Fluorine resin, length 1,000 mm <b>39.370 in</b> (not cuttable) Liquid surface not contacted: Beam received, Liquid surface contacted: Beam interrupted		Contact type, Liquid level sensing, -40 to +125 °C <b>-40 to 257 °F</b>	✂️ 2 m <b>6.562 ft</b> (Note 6)	P.62
<b>FD-FA93</b>	Applicable pipe diameter: Outer dia. ø8 mm <b>ø0.315 in</b> or more transparent pipe (When used with the tying bands: ø8 to ø80 mm <b>ø0.315 to ø3.150 in</b> ) [PFA (fluorine resin), including translucent] Liquid absent: Beam received, Liquid present: Beam interrupted		Pipe-mountable type, Liquid sensing, -40 to +70 °C <b>-40 to 158 °F</b>	✂️ 2 m <b>6.562 ft</b>	P.62
<b>FD-H13-FM2</b>	100 <b>3.937</b>	280 <b>11.024</b>	Heat-resistant, Threaded, -60 to +130 °C <b>-76 to 266 °F</b>		P.63
<b>FD-H18-L31</b>	0 to 10 <b>0 to 0.394</b>	0 to 25 <b>0 to 0.984</b>	Heat-resistant, Glass substrate detection convergent reflective, -60 to +180 °C <b>-76 to 356 °F</b>		P.63
<b>FD-H20-21</b>	90 <b>3.543</b>	280 <b>11.024</b>	Heat-resistant, Threaded, -60 to +200 °C <b>-76 to 392 °F</b>	1 m <b>3.281 ft</b>	P.63
<b>FD-H20-M1</b>	120 <b>4.724</b>	300 <b>11.811</b>	Heat-resistant, Threaded, -60 to +200 °C <b>-76 to 392 °F</b>		P.63
<b>FD-H25-L43</b> (Note 4)	4 to 16 <b>0.157 to 0.630</b>	4 to 23 <b>0.157 to 0.906</b>	Heat-resistant, Glass substrate detection convergent reflective, -20 to +250 °C <b>-4 to 482 °F</b> (Ordinary temp. side: -20 to +70 °C <b>-4 to 158 °F</b> )	3 m <b>9.843 ft</b>	P.63
<b>FD-H25-L45</b> (Note 4)	7 to 35 <b>0.276 to 1.378</b>	7 to 38 <b>0.276 to 1.496</b>	Heat-resistant, Glass substrate detection convergent reflective, -20 to +250 °C <b>-4 to 482 °F</b> (Ordinary temp. side: -20 to +70 °C <b>-4 to 158 °F</b> )		P.63
<b>FD-H30-KZ1V-S</b> (Note 4, 5)	25 to 80 <b>0.984 to 3.150</b>	10 to 220 <b>0.394 to 8.661</b>	Vacuum-resistant, Reflective, -30 to +300 °C <b>-22 to 572 °F</b>	1 m <b>3.281 ft</b>	P.64
<b>FD-H30-L32</b>	2 to 9 <b>0.079 to 0.354</b>	0 to 17 <b>0 to 0.669</b>	Heat-resistant, Glass substrate detection convergent reflective, -60 to +300 °C <b>-76 to 572 °F</b>	2 m <b>6.562 ft</b>	P.64
<b>FD-H30-L32V-S</b> (Note 4, 5)	2.5 to 6.5 <b>0.098 to 0.256</b>	0 to 11 <b>0 to 0.433</b>	Vacuum-resistant, Convergent reflective, -30 to +300 °C <b>-22 to 572 °F</b>	3 m <b>9.843 ft</b>	P.64
<b>FD-H35-20S</b>	85 <b>3.346</b>	200 <b>7.874</b>	Heat-resistant, Threaded, -60 to +350 °C <b>-76 to 662 °F</b>	1 m <b>3.281 ft</b>	P.64
<b>FD-H35-M2</b>	75 <b>2.953</b>	280 <b>11.024</b>	Heat-resistant, Threaded, -60 to +350 °C <b>-76 to 662 °F</b>	2 m <b>6.562 ft</b>	P.64
<b>FD-H35-M2S6</b>	75 <b>2.953</b>	280 <b>11.024</b>	Heat-resistant, Threaded, -60 to +350 °C <b>-76 to 662 °F</b>		P.64
<b>FD-HF40Y</b> (Note 3)	ø4 mm <b>ø0.157 in</b> Protective tube: Fluorine resin, length 500 mm <b>19.685 in</b> (cuttable) Liquid surface not contacted: Beam received, Liquid surface contacted: Beam not received		Contact type, Liquid level sensing, Metal-free, -40 to +105 °C <b>-40 to 221 °F</b>	✂️ 2 m <b>6.562 ft</b>	P.64
<b>FD-L10</b> (Note 4)	0 to 4.5 <b>0 to 0.177</b>	0 to 5.5 <b>0 to 0.217</b>	Glass substrate detection, -40 to +60 °C <b>-40 to 140 °F</b>		P.65
<b>FD-L11</b> (Note 4)	0 to 8 <b>0 to 0.315</b>	0 to 9 <b>0 to 0.354</b>	Glass substrate detection, -40 to +60 °C <b>-40 to 140 °F</b>		P.65
<b>FD-L12W</b> (Note 4)	1 to 4.5 <b>0.039 to 0.177</b>	0.5 to 7 <b>0.020 to 0.276</b>	Ultra-small, -40 to +60 °C <b>-40 to 140 °F</b>	✂️ 1 m <b>3.281 ft</b>	P.65
<b>FD-L20H</b>	5 to 15 <b>0.197 to 0.591</b>	1 to 30 <b>0.039 to 1.181</b>	General purpose, -40 to +70 °C <b>-40 to 158 °F</b>		P.65
<b>FD-L21</b> (Note 4)	3 to 15 <b>0.118 to 0.591</b>	1.5 to 16 <b>0.059 to 0.630</b>	Glass substrate detection, -40 to +60 °C <b>-40 to 140 °F</b>	✂️ 2 m <b>6.562 ft</b>	P.65
<b>FD-L21W</b> (Note 4)	7 to 12 <b>0.276 to 0.472</b>	3 to 14 <b>0.118 to 0.551</b>	Glass substrate detection, -40 to +60 °C <b>-40 to 140 °F</b>		P.65
<b>FD-L22A</b> (Note 4)	0 to 19 <b>0 to 0.748</b>	0 to 25 <b>0 to 0.984</b>	Glass substrate detection, 0 to +70 °C <b>32 to 158 °F</b>		P.65
<b>FD-L23</b> (Note 4)	0 to 28 <b>0 to 1.102</b>	0 to 30 <b>0 to 1.181</b>	Glass substrate detection, -20 to +70 °C <b>-4 to 158 °F</b>		P.65
<b>FD-L30A</b> (Note 4)	0 to 40 <b>0 to 1.575</b>	0 to 50 <b>0 to 1.969</b>	Glass substrate detection, 0 to +70 °C <b>32 to 158 °F</b>	✂️ 3 m <b>9.843 ft</b>	P.65
<b>FD-L31A</b> (Note 4)	5 to 30 <b>0.197 to 1.181</b>	4 to 33 <b>0.157 to 1.299</b>	Glass substrate detection, 0 to +70 °C <b>32 to 158 °F</b>		P.65
<b>FD-L32H</b> (Note 4)	16 to 30 <b>0.630 to 1.181</b>	0 to 50 <b>0 to 1.969</b>	Glass substrate detection, -40 to +60 °C <b>-40 to 140 °F</b>	✂️ 4 m <b>13.123 ft</b>	P.66

- Notes: 1) Note that the sensing range of the free-cut type fiber may be reduced by 20 % max. depending upon how the fiber is cut.  
 2) The sensing range of reflective type is the value for white non-glossy paper (as for **FD-H30-L32** and **FD-H18-L31** 50 × 50 mm **1.969 × 1.969 in** glass substrate).  
 3) Liquid inflow prevention joint, protective tube extension joint, fiber mounting joint are available. Please refer to p.38 for details.  
 4) The sensing range is specified for transparent glass 100 × 100 × t0.7 mm **3.937 × 3.937 × t0.028 in** (**FD-L32H**: R edge, **FD-L21** and **FD-L21W**: t2 mm **t0.079 in**) [**FD-L10**: silicon wafers 100 × 100 mm **3.937 × 3.937 in**].  
 5) Sold as a set comprising vacuum type fiber + photo-terminal (**FV-BR1**) + fiber at atmospheric side (**FT-J8**).  
 6) The allowable cutting range is 1,000 mm **39.370 in** from the end that is inserted to the amplifier.

- FIBER SENSORS
- LASER SENSORS
- PHOTO-ELECTRIC SENSORS
- MICRO PHOTO-ELECTRIC SENSORS
- AREA SENSORS
- LIGHT CURTAINS / SAFETY COMPONENTS
- PRESSURE / FLOW SENSORS
- INDUCTIVE PROXIMITY SENSORS
- PARTICULAR USE SENSORS
- SENSOR OPTIONS
- SIMPLE WIRE-SAVING UNITS
- WIRE-SAVING SYSTEMS
- MEASUREMENT SENSORS
- STATIC ELECTRICITY PREVENTION DEVICES
- LASER MARKERS
- PLC
- HUMAN MACHINE INTERFACES
- ENERGY CONSUMPTION VISUALIZATION COMPONENTS
- FA COMPONENTS
- MACHINE VISION SYSTEMS
- UV CURING SYSTEMS
- Selection Guide
- Fibers
- Fiber Amplifiers
- FX-500**
- FX-100**
- FX-300**
- FX-410**
- FX-311**
- FX-301-F7 / FX-301-F**

**LIST OF FIBERS**

**Reflective type**



Fibers are listed in alphabetic order. Refer to p.5~ "Fiber Selection" for details of each fiber.

Model No.	Sensing range (mm in) (Note 1) (Note 2)		Type / Ambient temperature	Fiber cable length ✂: Free-cut	Dimensions
	Standard type <b>FX-101</b> □	Long sensing range type <b>FX-102</b> □			
<b>FD-R31G</b>	45 <b>1.772</b>	150 <b>5.906</b>	Square head, M3, -55 to +80 °C <b>-67 to 176 °F</b>	✂ 2 m <b>6.562 ft</b>	P.66
<b>FD-R32EG</b>	20 <b>0.787</b>	68 <b>2.677</b>	Square head, M3, -40 to +70 °C <b>-40 to 158 °F</b>	500 mm <b>19.685 in</b>	P.66
<b>FD-R33EG</b>	7 <b>0.276</b>	22 <b>0.866</b>	Square head, M3, -20 to +60 °C <b>-4 to 140 °F</b>		P.66
<b>FD-R34EG</b>	17 <b>0.669</b>	60 <b>2.362</b>	Square head, M3, -40 to +70 °C <b>-40 to 158 °F</b>		P.66
<b>FD-R41</b>	60 <b>2.362</b>	170 <b>6.693</b>	Square head, M4, -55 to +80 °C <b>-67 to 176 °F</b>	✂ 2 m <b>6.562 ft</b>	P.66
<b>FD-R60</b>	110 <b>4.331</b>	240 <b>9.449</b>	Threaded, M6, Elbow, -55 to +80 °C <b>-67 to 176 °F</b>		P.66
<b>FD-R61Y</b>	85 <b>3.346</b>	185 <b>7.283</b>	Oil-resistant, Square head, M6, Cable-protection type, -55 to +80 °C <b>-67 to 176 °F</b>		P.66
<b>FD-S21</b>	25 <b>0.984</b>	70 <b>2.756</b>	Cylindrical, ø1.5 <b>0.059</b> , -55 to +80 °C <b>-67 to 176 °F</b>	1 m <b>3.281 ft</b>	P.66
<b>FD-S30</b>	45 <b>1.772</b>	155 <b>6.102</b>	Super quality, Cylindrical, ø3 <b>0.118</b> , -55 to +80 °C <b>-67 to 176 °F</b>	2 m <b>6.562 ft</b>	P.67
<b>FD-S31</b>	35 <b>1.378</b>	140 <b>5.512</b>	Cylindrical, ø3 <b>0.118</b> , -55 to +80 °C <b>-67 to 176 °F</b>	✂ 2 m <b>6.562 ft</b>	P.67
<b>FD-S32</b>	120 <b>4.724</b>	345 <b>13.583</b>	Cylindrical, ø3 <b>0.118</b> , -55 to +80 °C <b>-67 to 176 °F</b>		P.67
<b>FD-S32W</b>	80 <b>3.150</b>	230 <b>9.055</b>	Cylindrical, ø3 <b>0.118</b> , -40 to +60 °C <b>-40 to 140 °F</b>		P.67
<b>FD-S33GW</b>	45 <b>1.772</b>	140 <b>5.512</b>	Cylindrical, ø3 <b>0.118</b> , -40 to +60 °C <b>-40 to 140 °F</b>		P.67
<b>FD-S60Y</b>	140 <b>5.512</b>	300 <b>11.811</b>	Chemical-resistant, Chindrical, Metal-free, ø5.5 <b>0.217</b> , -40 to +70 °C <b>-40 to 158 °F</b>	✂ 2 m <b>6.562 ft</b> (Note 3)	P.67
<b>FD-V30</b>	25 <b>0.984</b>	75 <b>2.953</b>	Sleeve, Cylindrical, Side-view, ø3 <b>0.118</b> , -55 to +80 °C <b>-67 to 176 °F</b>	✂ 2 m <b>6.562 ft</b>	P.67
<b>FD-V30W</b>	6 <b>0.236</b>	20 <b>0.787</b>	Sleeve, Cylindrical, Side-view, ø3 <b>0.118</b> , -40 to +60 °C <b>-40 to 140 °F</b>		P.67
<b>FD-V50</b>	40 <b>1.575</b>	100 <b>3.937</b>	Sleeve, Cylindrical, Side-view, ø5 <b>0.197</b> , -55 to +80 °C <b>-67 to 176 °F</b>		P.68
<b>FD-Z20HBW</b>	2 to 30 <b>0.079 to 1.181</b>	1 to 90 <b>0.039 to 3.543</b>	Flat with boss, -40 to +60 °C <b>-40 to 140 °F</b>	✂ 1 m <b>3.281 ft</b>	P.68
<b>FD-Z20W</b>	2 to 32 <b>0.079 to 1.260</b>	1 to 80 <b>0.039 to 3.150</b>	Flat with boss, -40 to +60 °C <b>-40 to 140 °F</b>		P.68
<b>FD-Z40HBW</b>	1 to 90 <b>0.039 to 3.543</b>	0.5 to 240 <b>0.020 to 9.449</b>	Flat with boss, -40 to +60 °C <b>-40 to 140 °F</b>	✂ 2 m <b>6.562 ft</b>	P.68
<b>FD-Z40W</b>	1 to 74 <b>0.039 to 2.913</b>	200 <b>7.874</b>	Flat with boss, -40 to +60 °C <b>-40 to 140 °F</b>		P.68
<b>FD-Z50HW</b>	10 to 200 <b>0.394 to 7.874</b>	10 to 530 <b>0.394 to 20.866</b>	Narrow Beam, Long range, -40 to +60 °C <b>-40 to 140 °F</b>		P.68

Notes: 1) Note that the sensing range of the free-cut type fiber may be reduced by 20 % max. depending upon how the fiber is cut.  
 2) The sensing range is specified for white non-glossy paper.  
 3) The allowable cutting range is 500 mm **19.685 in** from the end that the amplifier inserted.

**Sensing range when FR-Z50HW is used in combination with a reflector (optional)**

Reflector Model No.	Sensing range (mm in)	
	Standard type <b>FX-101</b> □	Long sensing range type <b>FX-102</b> □
<b>RF-230</b>	100 to 2,400 <b>3.937 to 94.488</b>	100 to 5,000 <b>3.937 to 196.850</b>
<b>RF-220</b>	100 to 1,300 <b>3.937 to 51.181</b>	100 to 2,600 <b>3.937 to 102.362</b>
<b>RF-210</b>	100 to 980 <b>3.937 to 38.583</b>	100 to 1,300 <b>3.937 to 51.181</b>

Note: The sensing range is the possible setting range for the reflector.  
 The fiber can detect an object less than 100 mm **3.937 in**. However, note that if there are any white or highly-reflective surfaces near the fiber head, reflected incident light may affect the fiber head. If this occurs, adjust the threshold value of the amplifier unit before use.

FIBER SENSORS

LASER SENSORS

PHOTO-ELECTRIC SENSORS

MICRO PHOTO-ELECTRIC SENSORS

AREA SENSORS

LIGHT CURTAINS / SAFETY COMPONENTS

PRESSURE / FLOW SENSORS

INDUCTIVE PROXIMITY SENSORS

PARTICULAR USE SENSORS

SENSOR OPTIONS

SIMPLE WIRE-SAVING UNITS

WIRE-SAVING SYSTEMS

MEASUREMENT SENSORS

STATIC ELECTRICITY PREVENTION DEVICES

LASER MARKERS

PLC

HUMAN MACHINE INTERFACES

ENERGY CONSUMPTION VISUALIZATION COMPONENTS

FA COMPONENTS

MACHINE VISION SYSTEMS

UV CURING SYSTEMS

Selection Guide

Fibers

Fiber Amplifiers

**FX-500**

**FX-100**

**FX-300**

**FX-410**



**FX-311**

**FX-301-F7/ FX-301-F**

**FIBER OPTIONS**

Refer to p.69~ for details of lens dimensions.

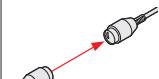
**Lens (For thru-beam type fiber)**

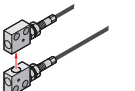
Designation	Model No.	Description																																															
Expansion lens (Note 1)	FX-LE1	 <p>Increases the sensing range by 5 times or more.</p> <ul style="list-style-type: none"> <li>Ambient temperature: -60 to +350 °C -76 to +662 °F (Note 4)</li> <li>Beam dia: <math>\varnothing 3.6</math> mm <math>\varnothing 0.142</math> in</li> </ul>	<p><b>Sensing range (mm in) [Lens on both sides]</b></p> <table border="1"> <thead> <tr> <th>Fiber</th> <th>Mode</th> <th>FX-101□</th> <th>FX-102□</th> </tr> </thead> <tbody> <tr> <td>FT-43</td> <td></td> <td>2,400 94.488</td> <td>3,600 141.732 (Note 2)</td> </tr> <tr> <td>FT-42</td> <td></td> <td rowspan="2">3,400 133.858</td> <td rowspan="2">3,600 141.732 (Note 2)</td> </tr> <tr> <td>FT-42W</td> <td></td> </tr> <tr> <td>FT-45X</td> <td></td> <td>1,600 62.992 (Note 2)</td> <td>1,600 62.992 (Note 2)</td> </tr> <tr> <td>FT-R40</td> <td></td> <td>3,100 122.047</td> <td>3,600 141.732 (Note 2)</td> </tr> <tr> <td>FT-R43</td> <td></td> <td>1,300 51.181</td> <td>3,600 141.732 (Note 2)</td> </tr> <tr> <td>FT-H35-M2</td> <td></td> <td>2,000 78.740</td> <td>3,500 137.795 (Note 2)</td> </tr> <tr> <td>FT-H20W-M1</td> <td></td> <td>1,300 51.181</td> <td>1,600 62.992 (Note 2)</td> </tr> <tr> <td>FT-H20-M1</td> <td></td> <td>1,600 62.992 (Note 2)</td> <td>1,600 62.992 (Note 2)</td> </tr> <tr> <td>FT-H20-J50-S</td> <td></td> <td rowspan="3">1,000 39.370</td> <td rowspan="3">3,500 137.795 (Note 2)</td> </tr> <tr> <td>FT-H20-J30-S</td> <td></td> </tr> <tr> <td>FT-H20-J20-S</td> <td></td> </tr> </tbody> </table>	Fiber	Mode	FX-101□	FX-102□	FT-43		2,400 94.488	3,600 141.732 (Note 2)	FT-42		3,400 133.858	3,600 141.732 (Note 2)	FT-42W		FT-45X		1,600 62.992 (Note 2)	1,600 62.992 (Note 2)	FT-R40		3,100 122.047	3,600 141.732 (Note 2)	FT-R43		1,300 51.181	3,600 141.732 (Note 2)	FT-H35-M2		2,000 78.740	3,500 137.795 (Note 2)	FT-H20W-M1		1,300 51.181	1,600 62.992 (Note 2)	FT-H20-M1		1,600 62.992 (Note 2)	1,600 62.992 (Note 2)	FT-H20-J50-S		1,000 39.370	3,500 137.795 (Note 2)	FT-H20-J30-S		FT-H20-J20-S	
			Fiber	Mode	FX-101□	FX-102□																																											
FT-43		2,400 94.488	3,600 141.732 (Note 2)																																														
FT-42		3,400 133.858	3,600 141.732 (Note 2)																																														
FT-42W																																																	
FT-45X		1,600 62.992 (Note 2)	1,600 62.992 (Note 2)																																														
FT-R40		3,100 122.047	3,600 141.732 (Note 2)																																														
FT-R43		1,300 51.181	3,600 141.732 (Note 2)																																														
FT-H35-M2		2,000 78.740	3,500 137.795 (Note 2)																																														
FT-H20W-M1		1,300 51.181	1,600 62.992 (Note 2)																																														
FT-H20-M1		1,600 62.992 (Note 2)	1,600 62.992 (Note 2)																																														
FT-H20-J50-S		1,000 39.370	3,500 137.795 (Note 2)																																														
FT-H20-J30-S																																																	
FT-H20-J20-S																																																	
Super-expansion lens (Note 1)	FX-LE2	 <p>Tremendously increases the sensing range with large diameter lenses.</p> <ul style="list-style-type: none"> <li>Ambient temperature: -60 to +350 °C -76 to +662 °F (Note 4)</li> <li>Beam dia: <math>\varnothing 9.8</math> mm <math>\varnothing 0.386</math> in</li> </ul>	<p><b>Sensing range (mm in) [Lens on both sides]</b></p> <table border="1"> <thead> <tr> <th>Fiber</th> <th>Mode</th> <th>FX-101□</th> <th>FX-102□</th> </tr> </thead> <tbody> <tr> <td>FT-43</td> <td></td> <td rowspan="3">3,600 141.732 (Note 2)</td> <td rowspan="3">3,600 141.732 (Note 2)</td> </tr> <tr> <td>FT-42</td> <td></td> </tr> <tr> <td>FT-42W</td> <td></td> </tr> <tr> <td>FT-45X</td> <td></td> <td>1,600 62.992 (Note 2)</td> <td>1,600 62.992 (Note 2)</td> </tr> <tr> <td>FT-R40</td> <td></td> <td>3,600 141.732 (Note 2)</td> <td>3,600 141.732 (Note 2)</td> </tr> <tr> <td>FT-R43</td> <td></td> <td>3,600 141.732 (Note 2)</td> <td>3,600 141.732 (Note 2)</td> </tr> <tr> <td>FT-H35-M2</td> <td></td> <td>3,500 137.795 (Note 2)</td> <td>3,500 137.795 (Note 2)</td> </tr> <tr> <td>FT-H20W-M1</td> <td></td> <td rowspan="2">1,600 62.992 (Note 2)</td> <td rowspan="2">1,600 62.992 (Note 2)</td> </tr> <tr> <td>FT-H20-M1</td> <td></td> </tr> <tr> <td>FT-H13-FM2</td> <td></td> <td>3,500 137.795 (Note 2)</td> <td>3,500 137.795 (Note 2)</td> </tr> <tr> <td>FT-H20-J50-S</td> <td></td> <td rowspan="3">3,500 137.795 (Note 2)</td> <td rowspan="3">3,500 137.795 (Note 2)</td> </tr> <tr> <td>FT-H20-J30-S</td> <td></td> </tr> <tr> <td>FT-H20-J20-S</td> <td></td> </tr> </tbody> </table>	Fiber	Mode	FX-101□	FX-102□	FT-43		3,600 141.732 (Note 2)	3,600 141.732 (Note 2)	FT-42		FT-42W		FT-45X		1,600 62.992 (Note 2)	1,600 62.992 (Note 2)	FT-R40		3,600 141.732 (Note 2)	3,600 141.732 (Note 2)	FT-R43		3,600 141.732 (Note 2)	3,600 141.732 (Note 2)	FT-H35-M2		3,500 137.795 (Note 2)	3,500 137.795 (Note 2)	FT-H20W-M1		1,600 62.992 (Note 2)	1,600 62.992 (Note 2)	FT-H20-M1		FT-H13-FM2		3,500 137.795 (Note 2)	3,500 137.795 (Note 2)	FT-H20-J50-S		3,500 137.795 (Note 2)	3,500 137.795 (Note 2)	FT-H20-J30-S		FT-H20-J20-S	
			Fiber	Mode	FX-101□	FX-102□																																											
FT-43		3,600 141.732 (Note 2)	3,600 141.732 (Note 2)																																														
FT-42																																																	
FT-42W																																																	
FT-45X		1,600 62.992 (Note 2)	1,600 62.992 (Note 2)																																														
FT-R40		3,600 141.732 (Note 2)	3,600 141.732 (Note 2)																																														
FT-R43		3,600 141.732 (Note 2)	3,600 141.732 (Note 2)																																														
FT-H35-M2		3,500 137.795 (Note 2)	3,500 137.795 (Note 2)																																														
FT-H20W-M1		1,600 62.992 (Note 2)	1,600 62.992 (Note 2)																																														
FT-H20-M1																																																	
FT-H13-FM2		3,500 137.795 (Note 2)	3,500 137.795 (Note 2)																																														
FT-H20-J50-S		3,500 137.795 (Note 2)	3,500 137.795 (Note 2)																																														
FT-H20-J30-S																																																	
FT-H20-J20-S																																																	
Side-view lens	FX-SV1	 <p>Beam axis is bent by 90°.</p> <ul style="list-style-type: none"> <li>Ambient temperature: -60 to +300 °C -76 to +572 °F (Note 4)</li> <li>Beam dia: <math>\varnothing 2.8</math> mm <math>\varnothing 0.110</math> in</li> </ul>	<p><b>Sensing range (mm in) [Lens on both sides]</b></p> <table border="1"> <thead> <tr> <th>Fiber</th> <th>Mode</th> <th>FX-101□</th> <th>FX-102□</th> </tr> </thead> <tbody> <tr> <td>FT-43</td> <td></td> <td>510 20.079</td> <td>1,400 55.118</td> </tr> <tr> <td>FT-42</td> <td></td> <td>500 19.685</td> <td>1,700 66.929</td> </tr> <tr> <td>FT-42W</td> <td></td> <td>480 18.898</td> <td>1,300 51.181</td> </tr> <tr> <td>FT-45X</td> <td></td> <td>540 21.260</td> <td>1,600 62.992 (Note 2)</td> </tr> <tr> <td>FT-R43</td> <td></td> <td>310 12.205</td> <td>930 36.614</td> </tr> <tr> <td>FT-H35-M2</td> <td></td> <td>280 11.024</td> <td>800 31.496</td> </tr> <tr> <td>FT-H20W-M1</td> <td></td> <td>140 5.512</td> <td>400 15.748</td> </tr> <tr> <td>FT-H20-M1</td> <td></td> <td>280 11.024</td> <td>840 33.071</td> </tr> <tr> <td>FT-H20-J50-S</td> <td></td> <td rowspan="3">150 5.906</td> <td rowspan="3">410 16.142</td> </tr> <tr> <td>FT-H20-J30-S</td> <td></td> </tr> <tr> <td>FT-H20-J20-S</td> <td></td> </tr> </tbody> </table>	Fiber	Mode	FX-101□	FX-102□	FT-43		510 20.079	1,400 55.118	FT-42		500 19.685	1,700 66.929	FT-42W		480 18.898	1,300 51.181	FT-45X		540 21.260	1,600 62.992 (Note 2)	FT-R43		310 12.205	930 36.614	FT-H35-M2		280 11.024	800 31.496	FT-H20W-M1		140 5.512	400 15.748	FT-H20-M1		280 11.024	840 33.071	FT-H20-J50-S		150 5.906	410 16.142	FT-H20-J30-S		FT-H20-J20-S			
			Fiber	Mode	FX-101□	FX-102□																																											
FT-43		510 20.079	1,400 55.118																																														
FT-42		500 19.685	1,700 66.929																																														
FT-42W		480 18.898	1,300 51.181																																														
FT-45X		540 21.260	1,600 62.992 (Note 2)																																														
FT-R43		310 12.205	930 36.614																																														
FT-H35-M2		280 11.024	800 31.496																																														
FT-H20W-M1		140 5.512	400 15.748																																														
FT-H20-M1		280 11.024	840 33.071																																														
FT-H20-J50-S		150 5.906	410 16.142																																														
FT-H20-J30-S																																																	
FT-H20-J20-S																																																	
Expansion lens for vacuum fiber (Note 1)	FV-LE1	 <p>Sensing range increases by 4 times or more.</p> <ul style="list-style-type: none"> <li>Ambient temperature: -60 to +350 °C -76 to +662 °F (Note 4)</li> <li>Beam dia: <math>\varnothing 3.6</math> mm <math>\varnothing 0.142</math> in</li> </ul>	<p><b>Sensing range (mm in) [Lens on both sides] (Note 3)</b></p> <table border="1"> <thead> <tr> <th>Fiber</th> <th>Mode</th> <th>FX-101□</th> <th>FX-102□</th> </tr> </thead> <tbody> <tr> <td>FT-H30-M1V-S</td> <td></td> <td>450 17.717</td> <td>1,600 62.992</td> </tr> </tbody> </table>	Fiber	Mode	FX-101□	FX-102□	FT-H30-M1V-S		450 17.717	1,600 62.992																																						
			Fiber	Mode	FX-101□	FX-102□																																											
FT-H30-M1V-S		450 17.717	1,600 62.992																																														
Vacuum-resistant side-view lens (Note 1)	FV-SV2	 <p>Beam axis is bent by 90°.</p> <ul style="list-style-type: none"> <li>Ambient temperature: -60 to +300 °C -76 to +572 °F (Note 4)</li> <li>Beam dia: <math>\varnothing 3.7</math> mm <math>\varnothing 0.146</math> in</li> </ul>	<p><b>Sensing range (mm in) [Lens on both sides] (Note 3)</b></p> <table border="1"> <thead> <tr> <th>Fiber</th> <th>Mode</th> <th>FX-101□</th> <th>FX-102□</th> </tr> </thead> <tbody> <tr> <td>FT-H30-M1V-S</td> <td></td> <td>450 17.717</td> <td>1,600 62.992</td> </tr> </tbody> </table>	Fiber	Mode	FX-101□	FX-102□	FT-H30-M1V-S		450 17.717	1,600 62.992																																						
			Fiber	Mode	FX-101□	FX-102□																																											
FT-H30-M1V-S		450 17.717	1,600 62.992																																														

- Notes: 1) Be careful sure to use it only after you have adjusted it sufficiently when installing the thru-beam type fiber equipped with the expansion lens, as the beam envelope becomes narrow and alignment is difficult.  
 2) The fiber cable length practically limits the sensing range.  
 3) The fiber cable length for the FT-H30-M1V-S is 1 m 3.28 ft. The sensing ranges in FX-102□ are specified considering the length of the FT-J8 atmospheric side fiber.  
 4) Refer to "LIST OF FIBERS (p.124~)" for the ambient temperature of fibers to be used in combination.

- FIBER SENSORS
- LASER SENSORS
- PHOTO-ELECTRIC SENSORS
- MICRO PHOTO-ELECTRIC SENSORS
- AREA SENSORS
- LIGHT CURTAINS/SAFETY COMPONENTS
- PRESSURE / FLOW SENSORS
- INDUCTIVE PROXIMITY SENSORS
- PARTICULAR USE SENSORS
- SENSOR OPTIONS
- SIMPLE WIRE-SAVING UNITS
- WIRE-SAVING SYSTEMS
- MEASUREMENT SENSORS
- STATIC ELECTRICITY PREVENTION DEVICES
- LASER MARKERS
- PLC
- HUMAN MACHINE INTERFACES
- ENERGY CONSUMPTION VISUALIZATION COMPONENTS
- FA COMPONENTS
- MACHINE VISION SYSTEMS
- UV CURING SYSTEMS
- Selection Guide
- Fibers
- Fiber Amplifiers
- FX-500
- FX-100
- FX-300
- FX-410
- FX-311
- FX-301-F7/
- FX-301-F

**FIBER OPTIONS**





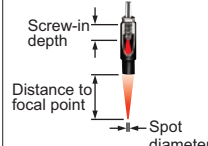
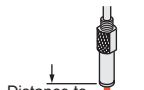
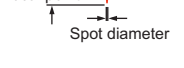
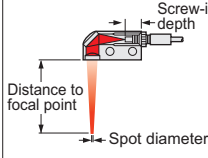



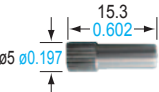

Refer to p.69~ for details of lens dimensions.

**Lens (For reflective type fiber)**

Designation		Model No.	Description	
For reflective type fiber	Pinpoint spot lens	<b>FX-MR1</b>		Pinpoint spot of $\varnothing 0.5$ mm $\varnothing 0.020$ in. Enables detection of minute objects or small marks. • Distance to focal point: $6 \pm 1$ mm $0.236 \pm 0.039$ in • Applicable fibers: <b>FD-42G, FD-42GW</b> • Ambient temperature: $-40$ to $+70$ °C $-40$ to $+158$ °F (Note)
	Zoom lens	<b>FX-MR2</b>		The spot diameter is adjustable from $\varnothing 0.7$ to $\varnothing 2$ mm $\varnothing 0.028$ to $\varnothing 0.079$ in according to how much the fiber is screwed in. • Applicable fibers: <b>FD-42G, FD-42GW</b> • Ambient temperature: $-40$ to $+70$ °C $-40$ to $+158$ °F (Note) • Accessory: <b>MS-EX3</b> (mounting bracket)
	Finest spot lens	<b>FX-MR3</b>		Extremely fine spot of $\varnothing 0.15$ mm $\varnothing 0.006$ in approx. achieved. • Applicable fibers: <b>FD-EG31, FD-EG30, FD-42G, FD-42GW, FD-32G, FD-32GX</b> • Ambient temperature: $-40$ to $+70$ °C $-40$ to $+158$ °F (Note)
	Finest spot lens	<b>FX-MR6</b>		Extremely fine spot of $\varnothing 0.1$ mm $\varnothing 0.004$ in approx. achieved. • Applicable fibers: <b>FD-EG31, FD-EG30, FD-42G, FD-42GW, FD-32G, FD-32GX</b> • Ambient temperature: $-20$ to $+60$ °C $-4$ to $+140$ °F (Note)
	Zoom lens (side-view type)	<b>FX-MR5</b>		<b>FX-MR2</b> is converted into a side-view type and can be mounted in a very small space. • Applicable fibers: <b>FD-42G, FD-42GW</b> • Ambient temperature: $-40$ to $+70$ °C $-40$ to $+158$ °F (Note)

Note: Refer to p.126 for the ambient temperature of fibers to be used in combination.

**Lens (For square head M3 reflective fiber)**

Type	Spot diameter (mm in)(Note)	Distance to focal point (mm in)(Note)	Lens		Fiber			
			Shape (mm in)	Model No.	Shape	Emitting fiber core (mm in)	Model No.	
For Square head M3 reflective fiber	Finest spot lens	$7 \pm 0.5$ $0.276 \pm 0.020$		<b>FX-MR7</b>		$\varnothing 0.125$	$\varnothing 0.005$	<b>FD-R33EG</b>
						$\varnothing 0.125$	$\varnothing 0.005$	<b>FD-EG31</b>
						$\varnothing 0.175$	$\varnothing 0.007$	<b>FD-R34EG</b>
						$\varnothing 0.25$	$\varnothing 0.010$	<b>FD-R32EG</b>
	$\varnothing 0.4$	$\varnothing 0.016$				$\varnothing 0.25$	$\varnothing 0.010$	<b>FD-EG30</b>
					$\varnothing 0.5$	$\varnothing 0.020$	<b>FD-R31G</b>	
					$\varnothing 0.5$	$\varnothing 0.020$	<b>FD-32G</b>	
					$\varnothing 0.5$	$\varnothing 0.020$	<b>FD-32GX</b>	
						$\varnothing 0.5$	$\varnothing 0.020$	<b>FD-42G</b>
						$\varnothing 0.5$	$\varnothing 0.020$	<b>FD-42GW</b>

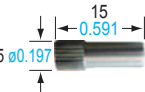
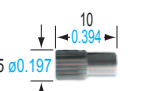
Type	Spot diameter (mm in)(Note)	Sensing range (mm in)(Note)	Lens		Applicable fibers			
			Shape (mm in)	Model No.	Emitting fiber core (mm in)	Model No.		
For Square head M3 reflective fiber	Zoom lens	$10$ to $30$ $0.394$ to $1.181$		<b>FX-MR8</b>	$\varnothing 0.125$	$\varnothing 0.005$	<b>FD-R33EG, FD-EG31</b>	
					$\varnothing 0.175$	$\varnothing 0.007$	<b>FD-R34EG</b>	
					$\varnothing 0.25$	$\varnothing 0.010$	<b>FD-R32EG, FD-EG30</b>	
					$\varnothing 0.5$	$\varnothing 0.020$	<b>FD-R31G, FD-32G, FD-32GX, FD-42G, FD-42GW</b>	
	Parallel light lens	$\varnothing 4.0$	$0$ to $30$ $0$ to $1.181$		<b>FX-MR9</b>	$\varnothing 0.125$	$\varnothing 0.005$	<b>FD-R33EG, FD-EG31</b>
						$\varnothing 0.175$	$\varnothing 0.007$	<b>FD-R34EG</b>
					$\varnothing 0.25$	$\varnothing 0.010$	<b>FD-R32EG, FD-EG30</b>	
					$\varnothing 0.5$	$\varnothing 0.020$	<b>FD-R31G, FD-32G, FD-32GX, FD-42G, FD-42GW</b>	

Note: Spot diameter, distance to focal point and sensing range are specified for FX-100 series.

FIBER SENSORS

LASER SENSORS

PHOTO-ELECTRIC SENSORS

MICRO PHOTO-ELECTRIC SENSORS

AREA SENSORS

LIGHT CURTAINS / SAFETY COMPONENTS

PRESSURE / FLOW SENSORS

INDUCTIVE PROXIMITY SENSORS

PARTICULAR USE SENSORS

SENSOR OPTIONS

SIMPLE WIRE-SAVING UNITS

WIRE-SAVING SYSTEMS

MEASUREMENT SENSORS

STATIC ELECTRICITY PREVENTION DEVICES

LASER MARKERS

PLC

HUMAN MACHINE INTERFACES

ENERGY CONSUMPTION VISUALIZATION COMPONENTS

FA COMPONENTS

MACHINE VISION SYSTEMS

UV CURING SYSTEMS

Selection Guide

Fibers

Fiber Amplifiers

**FX-500**

**FX-100**

**FX-300**

**FX-410**

**FX-311**

FX-301-F7/  
FX-301-F

## SPECIFICATIONS

Item	Model No.	Type	Standard type		Long sensing range type	
			NPN output	Cable set	Cable set	Cable set
		PNP output	FX-101P(-Z) (Note 5)	FX-101P-CC2	FX-102P(-Z) (Note 5)	FX-102P-CC2
Supply voltage			12 to 24 V DC $\pm 10\%$ Ripple P-P 10% or less			
Power consumption			Normal operation: 720 mW or less (Current consumption 30 mA or less at 24 V supply voltage) ECO mode: 600 mW or less (Current consumption 25 mA or less at 24 V supply voltage)			
Output		<NPN output type> NPN open-collector transistor	<PNP output type> PNP open-collector transistor			
		<ul style="list-style-type: none"> <li>Maximum sink current: 100 mA</li> <li>Applied voltage: 30 V DC or less (between output and 0 V)</li> <li>Residual voltage: 1.5 V or less (at 100 mA sink current)</li> </ul>	<ul style="list-style-type: none"> <li>Maximum source current: 100 mA</li> <li>Applied voltage: 30 V DC or less (between output and +V)</li> <li>Residual voltage: 1.5 V or less (at 100 mA source current)</li> </ul>			
	Output operation	Selectable either Light-ON or Dark-ON, at SET mode				
Short-circuit protection			Incorporated			
External input		<NPN output type> NPN non-contact input	<PNP output type> PNP non-contact input			
		<ul style="list-style-type: none"> <li>Signal condition</li> <li>High: +8 V to +V DC or Open</li> <li>Low: 0 to +2 V DC (Source current 0.5 mA or less)</li> <li>Input impedance: 10 k<math>\Omega</math> approx.</li> </ul>	<ul style="list-style-type: none"> <li>Signal condition</li> <li>High: +4 V to +V DC (Sink current 0.5 to 3 mA)</li> <li>Low: 0 to +0.6 V DC or Open</li> <li>Input impedance: 10 k<math>\Omega</math> approx.</li> </ul>			
Response time		Emission frequency 0: 250 $\mu$ s or less (factory default setting) Emission frequency 1: 450 $\mu$ s or less Emission frequency 2: 500 $\mu$ s or less Emission frequency 3: 600 $\mu$ s or less	Emission frequency 1: 2.5 ms or less (factory default setting) Emission frequency 2: 2.8 ms or less Emission frequency 3: 3.2 ms or less Emission frequency 4: 5.0 ms or less			
Sensitivity setting			2-point teaching / Limit teaching / Full-auto teaching			
Operation indicator			Orange LED (lights up when the output is ON)			
Digital display			4 digits (green) + 4 digits (red) LCD display			
Fine sensitivity adjustment function			Incorporated			
Timer function			ON-delay / OFF-delay timer, switchable either effective or ineffective [Timer period: 1 ms, 5 ms, 10 ms, 20 ms, 40 ms, 50 ms, 100 ms, 500 ms, 1,000 ms]			
Emission amount setting function			3-level + Auto setting (from production in December 2007)			
Interference prevention function		Incorporated Emission frequency selection method (Note 2) (Functions at emission frequency 1, 2 or 3)	Incorporated Emission frequency selection method (Note 2) (Functions at emission frequency 1, 2, 3 or 4)			
Environmental resistance	Ambient temperature	-10 to +55 °C +14 to +131 °F (If 4 to 7 units are mounted close together: -10 to +50 °C +14 to +122 °F, if 8 to 16 units are mounted close together: -10 to +45 °C +14 to +113 °F) (No dew condensation or icing allowed), Storage: -20 to +70 °C -4 to +158 °F				
	Ambient humidity	35 to 85 % RH, Storage: 35 to 85 % RH				
	Ambient illuminance	Incandescent light: 3,000 lx at the light-receiving face				
	Voltage withstandability	1,000 V AC for one min. between all supply terminals connected together and enclosure (Note 3)				
	Insulation resistance	20 M $\Omega$ , or more, with 250 V DC megger between all supply terminals connected together and enclosure (Note 3)				
	Vibration resistance	10 to 150 Hz frequency, 0.75 mm 0.030 in amplitude in X, Y and Z directions for two hours each				
	Shock resistance	98 m/s <sup>2</sup> acceleration (10 G approx.) in X, Y and Z directions for five times each				
Emitting element (modulated)			Red LED (Peak emission wavelength: 643 nm 0.025 mil)			
Material			Enclosure: Polycarbonate, Key switch: Polycarbonate, Fiber lock lever: PBT			
Connecting method			Connector (Note 4)			
Cable length			Total length up to 100 m 328.084 ft is possible with 0.3 mm <sup>2</sup> , or more, cable.			
Weight		Net weight: 15 g approx. Gross weight: 35 g approx.	Net weight: 15 g approx. Gross weight: 75 g approx.	Net weight: 15 g approx. Gross weight: 35 g approx.	Net weight: 15 g approx. Gross weight: 75 g approx.	
Accessory		FC-FX-1 (Protection cover): 1 pc. (Note 6)	FC-FX-1 (Protection cover): 1 pc. (Note 6) CN-14A-C2 (Connector attached cable, 2 m 6.562 ft long): 1 pc.	FC-FX-1 (Protection cover): 1 pc. (Note 6)	FC-FX-1 (Protection cover): 1 pc. (Note 6) CN-14A-C2 (Connector attached cable, 2 m 6.562 ft long): 1 pc.	

Notes: 1) Where measurement conditions have not been specified precisely, the conditions used were an ambient temperature of +23 °C +73.4 °F.

2) When using the interference prevention function, set the emission frequencies for the amplifiers to be covered by the interference prevention function to different frequency values.

However, the interference prevention function does not operate at emission frequency 0 (factory default setting) for the FX-101(P)(-Z) / FX-101(P)-CC2.

3) The voltage withstandability and the insulation resistance values given in the above table are for the amplifier only.

4) Connector attached cable CN-14A-C2 is not attached to the models that have no "-CC2" at the end of the model Nos.

Make sure to use the optional connector attached cable CN-14A(-R)-C□ or the connector CN-14A, or a connector manufactured by J.S.T. Mfg., Ltd. (contact: SPHD-001T-P0.5, housing: PAP-04V-S).

5) Model Nos. having the suffix "-Z" are M8 plug-in connector type. Make sure to use the optional M8 attached connector cable CN-24A-C□.

6) Protection cover FC-FX-1 has been attached from production in July, 2011.

**I/O CIRCUIT AND WIRING DIAGRAMS**

**FX-10□(-Z/-CC2) NPN output type**

**I/O circuit diagram**

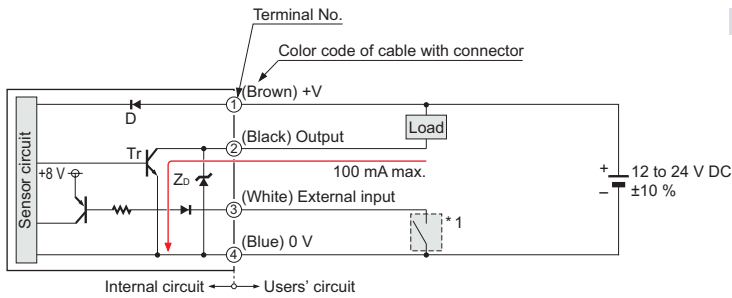

Symbols ... D : Reverse supply polarity protection diode  
 Zd: Surge absorption zener diode  
 Tr: NPN output transistor

\* 1  
 Non-voltage contact or NPN open-collector transistor

High (+8 V to +V DC, or open): Ineffective  
 Low [0 to +2 V DC (source current 0.5 mA or less)]: Effective

**Terminal arrangement diagram**

**Connector type**

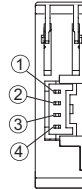

Terminal No.	Function
①	+V
②	Output
③	External input
④	0 V

**M8 plug-in connector type**

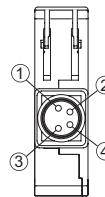

Terminal No.	Function
①	+V
②	Output
③	External input
④	0 V

**FX-10□P(-Z/-CC2) PNP output type**

**I/O circuit diagram**

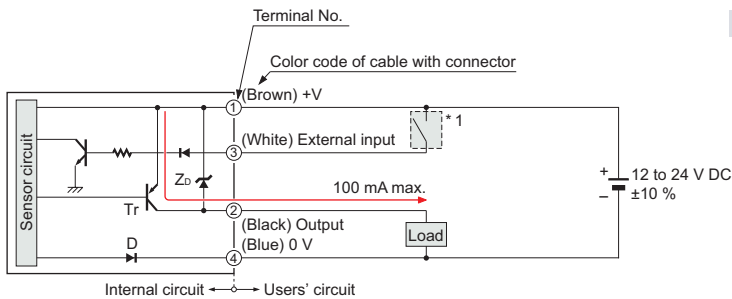

Symbols ... D : Reverse supply polarity protection diode  
 Zd: Surge absorption zener diode  
 Tr: PNP output transistor

\* 1  
 Non-voltage contact or PNP open-collector transistor

High [+4 V to +V DC (sink current 0.5 to 3 mA)]: Effective  
 Low (0 to +0.6 V DC, or open): Ineffective

**Terminal arrangement diagram**

**Connector type**

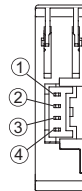

Terminal No.	Function
①	+V
②	Output
③	External input
④	0 V

**M8 plug-in connector type**

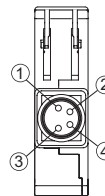

Terminal No.	Function
①	+V
②	Output
③	External input
④	0 V

- FIBER SENSORS
- LASER SENSORS
- PHOTO-ELECTRIC SENSORS
- MICRO PHOTO-ELECTRIC SENSORS
- AREA SENSORS
- LIGHT CURTAINS / SAFETY COMPONENTS
- PRESSURE / FLOW SENSORS
- INDUCTIVE PROXIMITY SENSORS
- PARTICULAR USE SENSORS
- SENSOR OPTIONS
- SIMPLE WIRE-SAVING UNITS
- WIRE-SAVING SYSTEMS
- MEASUREMENT SENSORS
- STATIC ELECTRICITY PREVENTION DEVICES
- LASER MARKERS
- PLC
- HUMAN MACHINE INTERFACES
- ENERGY CONSUMPTION VISUALIZATION COMPONENTS
- FA COMPONENTS
- MACHINE VISION SYSTEMS
- UV CURING SYSTEMS
- Selection Guide
- Fibers
- Fiber Amplifiers
- FX-500**
- FX-100**
- FX-300**
- FX-410**
- FX-311**
- FX-301-F7/ FX-301-F**

**SENSING CHARACTERISTICS (TYPICAL)**

**FIBER SENSORS**

LASER SENSORS

PHOTO-ELECTRIC SENSORS

MICRO PHOTO-ELECTRIC SENSORS

AREA SENSORS

LIGHT CURTAINS/SAFETY COMPONENTS

PRESSURE / FLOW SENSORS

INDUCTIVE PROXIMITY SENSORS

PARTICULAR USE SENSORS

SENSOR OPTIONS

SIMPLE WIRE-SAVING UNITS

WIRE-SAVING SYSTEMS

MEASUREMENT SENSORS

STATIC ELECTRICITY PREVENTION DEVICES

LASER MARKERS

PLC

HUMAN MACHINE INTERFACES

ENERGY CONSUMPTION VISUALIZATION COMPONENTS

FA COMPONENTS

MACHINE VISION SYSTEMS

UV CURING SYSTEMS

Selection Guide

Fibers

Fiber Amplifiers

**FX-500**

**FX-100**

**FX-300**

**FX-410**

**FX-311**

**FX-301-F7/ FX-301-F**

**FT-31S** Thru-beam type

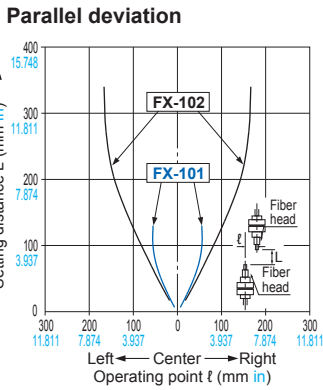

**FT-31W** Thru-beam type

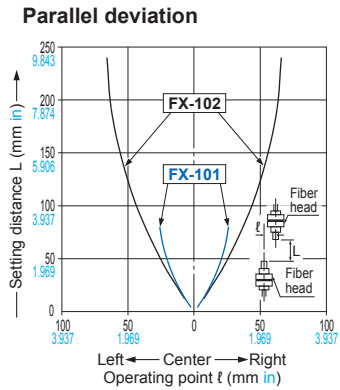

**FT-42S** Thru-beam type

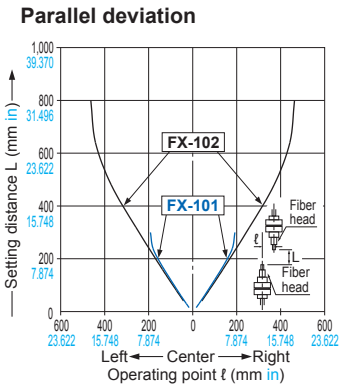

**FT-42W** Thru-beam type

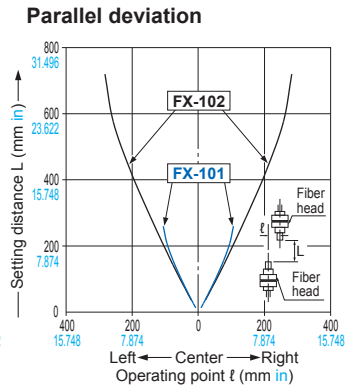

**FT-43** Thru-beam type

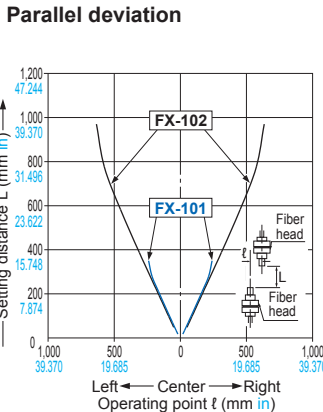

**FT-45X** Thru-beam type

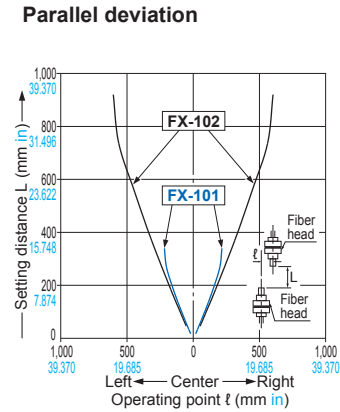

**FT-A11** Thru-beam type

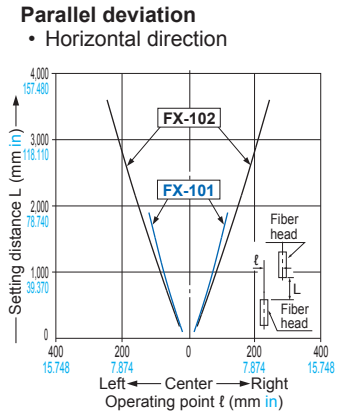

**FT-A11** Thru-beam type

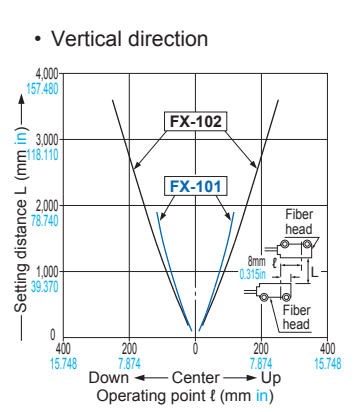

**FT-S21W** Thru-beam type

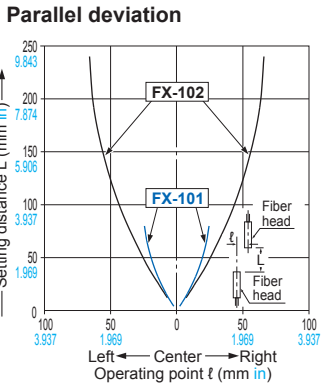

**FT-S31W** Thru-beam type

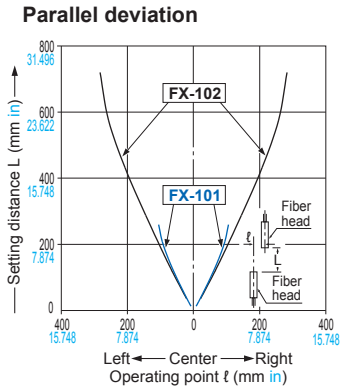

**FD-32G** Reflective type

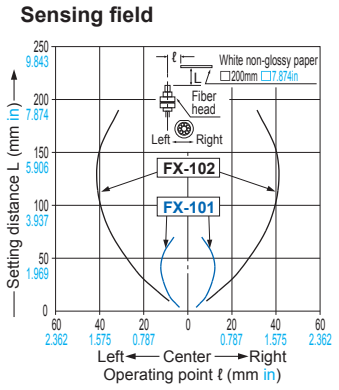

**FD-32GX** Reflective type

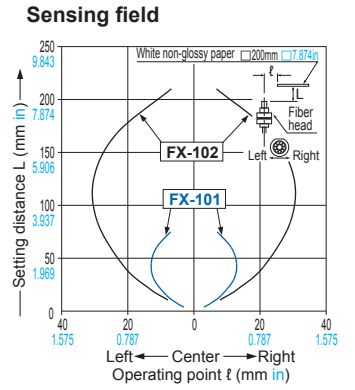

**FD-41S** Reflective type

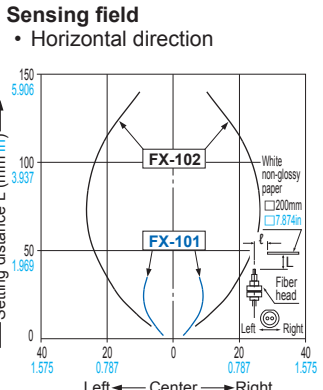

**FD-41W** Reflective type

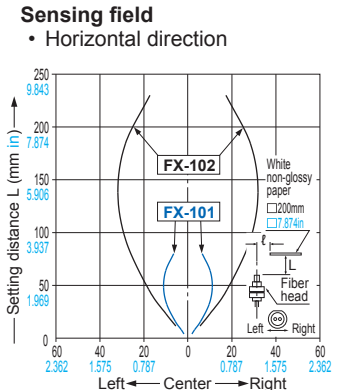

**FD-41W** Reflective type

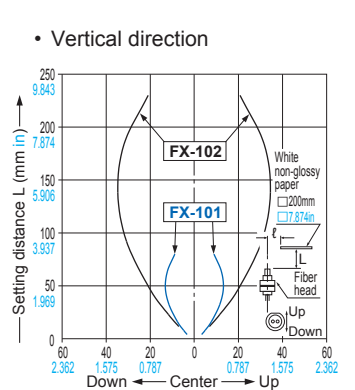

**SENSING CHARACTERISTICS (TYPICAL)**

**FD-42G** Reflective type

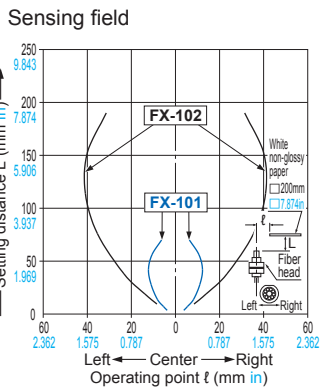

**FD-42GW** Reflective type

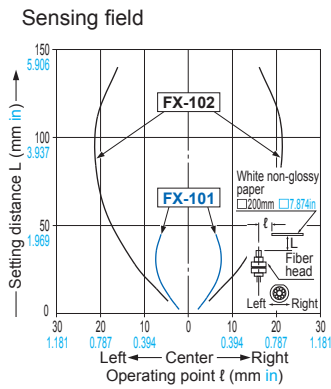

**FD-61G** Reflective type

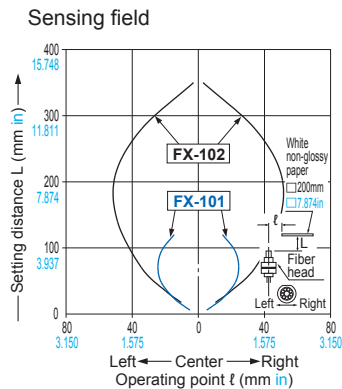

**FD-61W** Reflective type

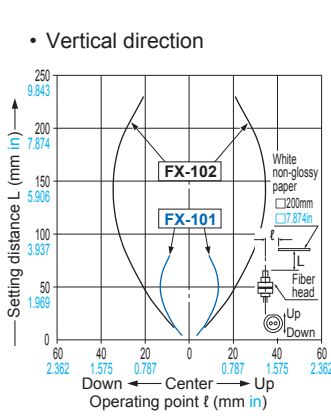
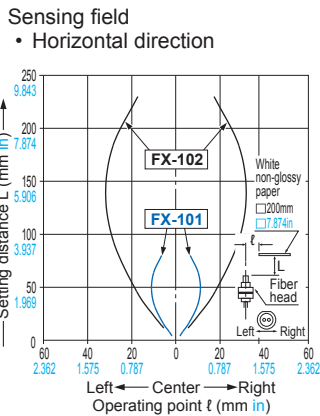

**FD-62** Reflective type

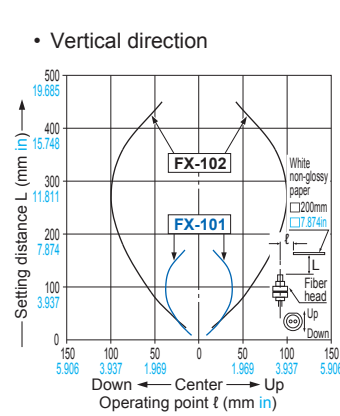
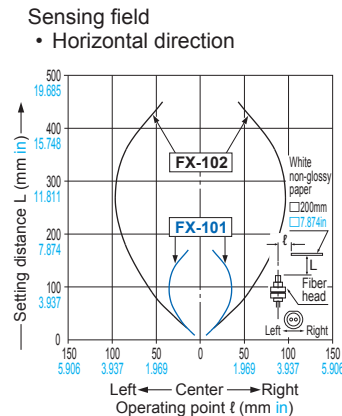

**FD-64X** Reflective type

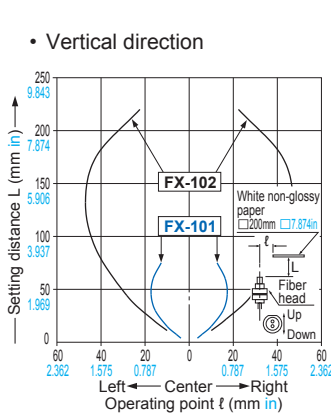
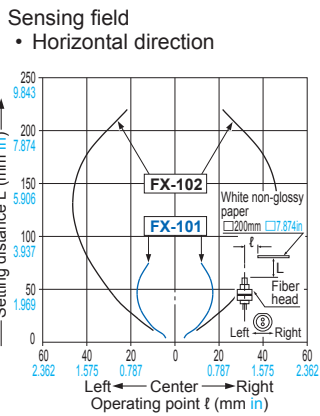

**FD-S32W** Reflective type

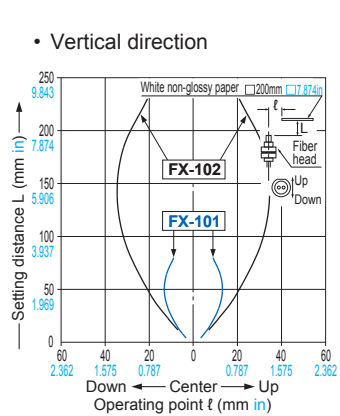
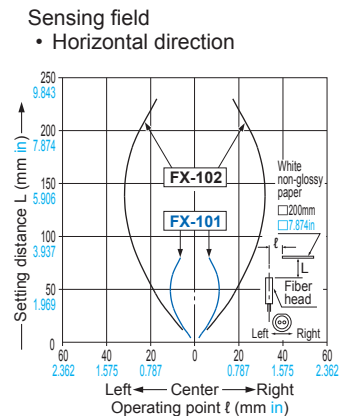

**FD-S33GW** Reflective type

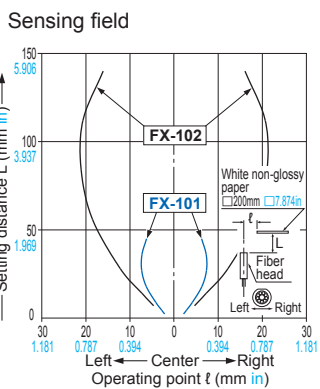

FIBER SENSORS

LASER SENSORS

PHOTO-ELECTRIC SENSORS

MICRO PHOTO-ELECTRIC SENSORS

AREA SENSORS

LIGHT CURTAINS / SAFETY COMPONENTS

PRESSURE / FLOW SENSORS

INDUCTIVE PROXIMITY SENSORS

PARTICULAR USE SENSORS

SENSOR OPTIONS

SMILE WIRE-SAVING UNITS

WIRE-SAVING SYSTEMS

MEASUREMENT SENSORS

STATIC ELECTRICITY PREVENTION DEVICES

LASER MARKERS

PLC

HUMAN MACHINE INTERFACES

ENERGY CONSUMPTION VISUALIZATION COMPONENTS

FA COMPONENTS

MACHINE VISION SYSTEMS

UV CURING SYSTEMS

Selection Guide

Fibers

Fiber Amplifiers

**FX-500**

**FX-100**

**FX-300**

**FX-410**

**FX-311**

**FX-301-F7/ FX-301-F**



FIBER SENSORS

LASER SENSORS

PHOTO-ELECTRIC SENSORS

MICRO PHOTO-ELECTRIC SENSORS

AREA SENSORS

LIGHT CURTAINS / SAFETY COMPONENTS

PRESSURE / FLOW SENSORS

INDUCTIVE PROXIMITY SENSORS

PARTICULAR USE SENSORS

SENSOR OPTIONS

SIMPLE WIRE-SAVING UNITS

WIRE-SAVING SYSTEMS

MEASURE-MENT SENSORS

STATIC ELECTRICITY PREVENTION DEVICES

LASER MARKERS

PLC

HUMAN MACHINE INTERFACES

ENERGY CONSUMPTION VISUALIZATION COMPONENTS

FA COMPONENTS

MACHINE VISION SYSTEMS

UV CURING SYSTEMS

Selection Guide

Fibers

Fiber Amplifiers

**FX-500**

**FX-100**

**FX-300**

**FX-410**

**FX-311**

**FX-301-F7 / FX-301-F**

## PRECAUTIONS FOR PROPER USE



- Never use this product as a sensing device for personnel protection.
- In case of using sensing devices for personnel protection, use products which meet laws and standards, such as OSHA, ANSI or IEC etc., for personnel protection applicable in each region or country.

### Using in combination with the FX-300 / FX-410 series

- The **FX-100** series does not use the horizontal connectors that are used with the **FX-300 / FX-410** series. Please note that horizontal connection cannot be performed using a connector attached cable. In addition, the optical communication function is not equipped on the **FX-100** series, so it is unable to perform interference prevention for use with the **FX-300 / FX-410** series. If using the **FX-100** series together with the **FX-300 / FX-410** series side-by-side, please set the same models together in groups.

### Mounting

#### <When using a DIN rail>

##### How to mount the amplifier

- ① Fit the rear part of the mounting section of the amplifier on a 35 mm 1.378 in width DIN rail.
- ② Press down the rear part of the mounting section of the unit on the 35 mm 1.378 in width DIN rail and fit the front part of the mounting section to the DIN rail.

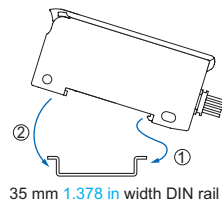

##### How to remove the amplifier

- ① Push the amplifier forward.
- ② Lift up the front part of the amplifier to remove it.

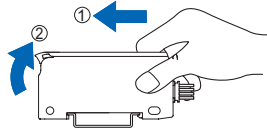

Note: Take care that if the front part is lifted without pushing the amplifier forward, the hook on the rear portion of the mounting section is likely to break.

#### <When using screws with washers>

- Use M3 screws with washers for mounting. The tightening torque should be 0.5 N·m or less.

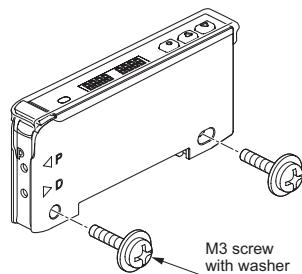

Refer to General precautions, and to the "Operation Guide" on our website for details pertaining to operating instructions for the amplifier.

### Wiring

- Make sure that the power supply is OFF while adding or removing the amplifiers.
- Note that if a voltage exceeding the reted range is applied, or if an AC power supply is directly connected, the product may get burnt or damaged.
- Note that short-circuit of the load or wrong wiring may burn or damage the product.
- Do not run the wires together with high-voltage lines or power lines, or put them in the same raceway. This can cause malfunction due to induction.
- Verify that the supply voltage variation is within the rating.
- If power is supplied from a commercial switching regulator, ensure that the frame ground (F.G.) terminal of the power supply is connected to an actual ground.
- In case noise generating equipment (switching regulator, inverter motor, etc.) is used in the vicinity of this product, connect the frame ground (F.G.) terminal of the equipment to an actual ground.
- Make sure to use the quick-connection cable (optional) for the connection of the controller. Extension up to total 100 m 328.084 ft is possible with 0.3 mm<sup>2</sup> or more, cable. However, in order to reduce noise, make the wiring as short as possible.

### Part description

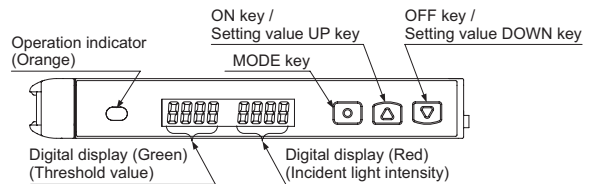

### Setting mode

- Setting mode appears after the MODE key is pressed for 2 sec. in RUN mode.

Setting item	Factory setting	Description
Teaching mode		Threshold value can be set in 2-point teaching, limit teaching, or full-auto teaching.
Output operation setting		Light-ON or Dark-ON can be set.
Timer operation setting		Without timer, ON delay timer, or OFF delay timer can be set.
Timer delays setting	 	When setting ON delay timer or OFF delay timer in the timer operation setting mode, timer delays can be set. • When timer is not set, this mode is not displayed.
Emission amount setting		In case incident light intensity is saturated, emission amount can be reduced.
Emission frequency setting	 	When using the fiber heads in parallel, interference can be prevented by setting different emission frequency. However, when emission frequency 0 is set, interference cannot be prevented. Response time corresponds to emission frequency.

\* Indicated as "PctL off" before production in November 2007.

## PRECAUTIONS FOR PROPER USE

### PRO mode

- PRO mode appears after the MODE key is pressed for 4 sec. in RUN mode.

Setting item	Factory setting	Description
Shift setting	[Shift amount 15 %]	Shift amount can be selected from 0 to 80 % in the limit teaching. Select 0 % when it is desired to set the present incident light intensity as a threshold value.
External input setting	[Emission halt]	External input can be selected from emission halt, limit teaching [+], limit teaching [-], full-auto teaching, ECO (Note 1), 2-point teaching or emission amount test. When setting the incident light intensity test "ESE", output turns ON / OFF every 100ms when the rate of incident light intensity and threshold value is less than half of the set shift amount (for example, when the rate of incident light intensity and threshold value is within ±10 % for 20 % of shift amount) at external input.
Threshold value-storing setting mode (Note 2)	[OFF]	Threshold value set at the limit teaching, full-auto teaching or 2-point teaching by external input is stored. When selecting Auto in the emission amount setting mode, the set emission amount level is also stored.
Threshold value follow-up cycle setting (Note 3)	[OFF]	When incident light intensity exceeds threshold value, this mode can change the threshold value with each set cycle depending on variations of the incident light intensity. The follow-up shift amount is same as the one set in the shift setting mode. However, the threshold value is not stored.
GETA function setting (Note 4, 5)	[OFF]	Variations can be reduced by correcting the present incident light intensity in each amplifier to a target value. Target value to offset incident light intensity can be selected from 0 to 2,000 by 100 unit each. For example, if the target value is set to 2,000 when the incident light intensity is 1,500, the incident light intensity becomes 2,000.
ECO setting	[OFF]	It is possible to light up / turn off the digital display. When ECO setting mode is ON, the display turns off in 20 sec. approx. in RUN mode. To light up the display again, press any key for 2 sec. or more.
Digital display inversion setting	[OFF]	Digital display can be inverted.
Threshold value margin setting	[OFF]	Margin for threshold value to the present incident light intensity can be checked. When there is no margin, it is possible to make the digital display blink. off : Set to "OFF": does not function. Grn : Green blinks. Red : Red blinks. Rlt : Red and green blink. In-t : When conducting limit teaching or 2-point teaching by external input, in case the rate of reference incident light intensity and threshold value after teaching is 200% or more, or in case it is less than half of the shift amount, output turns ON / OFF every 100 ms. (Note 6)
Setting copy	[NO]	The settings of the master side amplifier can be copied to the slave side amplifier. For details, refer to "Setting copy function".
Reset	[NO]	Returns to default settings (factory settings.)

- Notes: 1) When ECO is selected at the external input setting mode, key operation on the main body is invalid during external input.  
 2) This mode is not indicated unless any of "LtcP", "Ltc-", "Ruto" or "2-Plt" is set at the external input setting mode. (Incorporated from production in December 2007.)  
 3) If the incident light intensity becomes "300" or less, the follow-up operation stops. In that condition, threshold value [digital display (green)] blinks. This function can be used when thru-beam type or retroreflective type fiber is applied to this product. If reflective type fiber is applied, the function cannot be used depending on use conditions.  
 4) If MODE key is pressed in RUN mode when GETA function is used, the incident light intensity before setting GETA function is displayed on the red digital display for 2 sec. approx.  
 5) When GETA function is used in saturation of incident light intensity (4,000 or more,) "HRR-d" is indicated on the red digital display. Correction value is up to 4,000.  
 6) This mode does not operate unless any of "LtcP", "Ltc-" or "2-Plt" is set at the external input setting mode. (Incorporated from production in December 2007.)

Refer to General precautions, and to the "Operation Guide" on our website for details pertaining to operating instructions for the amplifier.

### Setting copy function

- This can copy the settings of the master side amplifier to the slave side amplifier.

- Be sure to use the setting copy function between the identical models (Between FX-101□ models or FX-102□ models). This function cannot be used between different models.
- Only one sensor can be connected on slave side with a master side sensor for the setting copy function.
- Threshold value, output operation setting, timer operation setting, timer setting, light-emitting amount setting, shift setting, external input setting, threshold value margin setting, ECO setting, digital display inversion setting, and threshold value margin setting can be copied.

#### <Setting procedures>

- ① Set the setting copy mode of the master side amplifier to "Copy sending ON", and press the MODE key so that "COPY SEND" is shown on the digital display and the sensor is in copy ready state. For the setting method, refer to "Operation guide".
- ② Turn off the master side amplifier.
- ③ Connect the master side amplifier with the slave side amplifier as shown below.

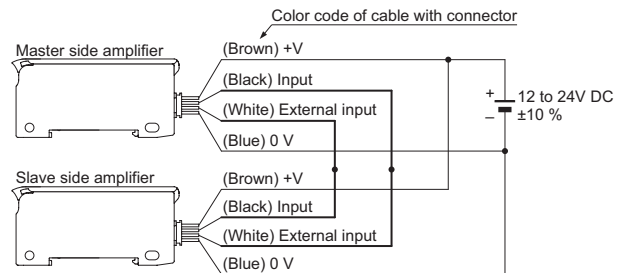

- ④ Turn on the master side amplifier and the slave side amplifier at the same time. (Note)
- ⑤ "COPY" is shown on the green digital display of the master side amplifier and 4-digit code is shown on the red digital display of it, then the copying starts. During copy communication, "COPY" is shown on the green digital display of the slave side amplifier, and the ongoing copy communication indicator ("I" → "II" → "III" → "IIII" → "IIII" → "IIII" → "IIII" → "IIII") is displayed on the red digital display.
- ⑥ When the copying is completed, "Good" is shown on the green digital display of the slave side amplifier, while the 4-digit code (the same code as the master side amplifier) is shown on the red digital display of it.
- ⑦ Turn off the power of the master side amplifier and the slave side amplifier and disconnect the wire.

\* If copying the settings to another amplifier repeatedly, follow the steps ③ to ⑦.

Note: Take care that if the power is not turned on at the same time, the setting contents may not be copied.

#### <To cancel the setting copy mode of the master side amplifier>

- ① While the slave side amplifier is disconnected, turn on the power of the master side amplifier.
- ② Press the MODE key for 2 sec. approx.

FIBER SENSORS

LASER SENSORS

PHOTO-ELECTRIC SENSORS

MICRO PHOTO-ELECTRIC SENSORS

AREA SENSORS

LIGHT CURTAINS / SAFETY COMPONENTS

PRESSURE / FLOW SENSORS

INDUCTIVE PROXIMITY SENSORS

PARTICULAR USE SENSORS

SENSOR OPTIONS

SIMPLE WIRE-SAVING UNITS

WIRE-SAVING SYSTEMS

MEASUREMENT SENSORS

STATIC ELECTRICITY PREVENTION DEVICES

LASER MARKERS

PLC

HUMAN MACHINE INTERFACES

ENERGY CONSUMPTION VISUALIZATION COMPONENTS

FA COMPONENTS

MACHINE VISION SYSTEMS

UV CURING SYSTEMS

Selection Guide

Fibers

Fiber Amplifiers

FX-500

FX-100

FX-300

FX-410

FX-311

FX-301-F7/  
FX-301-F

- FIBER SENSORS
- LASER SENSORS
- PHOTO-ELECTRIC SENSORS
- MICRO PHOTO-ELECTRIC SENSORS
- AREA SENSORS
- LIGHT CURTAINS / SAFETY COMPONENTS
- PRESSURE / FLOW SENSORS
- INDUCTIVE PROXIMITY SENSORS
- PARTICULAR USE SENSORS
- SENSOR OPTIONS
- SIMPLE WIRE-SAVING UNITS
- WIRE-SAVING SYSTEMS
- MEASURE-MENT SENSORS
- STATIC ELECTRICITY PREVENTION DEVICES
- LASER MARKERS
- PLC
- HUMAN MACHINE INTERFACES
- ENERGY CONSUMPTION VISUALIZATION COMPONENTS
- FA COMPONENTS
- MACHINE VISION SYSTEMS
- UV CURING SYSTEMS
- Selection Guide
- Fibers
- Fiber Amplifiers
- FX-500**
- FX-100**
- FX-300**
- FX-410**
- FX-311**
- FX-301-F7/  
FX-301-F

## PRECAUTIONS FOR PROPER USE

Refer to General precautions, and to the "Operation Guide" on our website for details pertaining to operating instructions for the amplifier.

### Others

- Our products have been developed / produced for industrial use only.
- Do not use during the initial transient time (0.5 sec.) after the power supply is switched on.
- Take care that the product is not directly exposed to fluorescent lamp from a rapid-starter lamp, a high frequency lighting device or sunlight etc., as it may affect the sensing performance.
- This product is suitable for indoor use only.
- Avoid dust, dirt, and steam.
- Take care that the product does not come in contact with oil, grease, organic solvents, such as thinner, etc., strong acid or alkaline.
- This product cannot be used in an environment containing inflammable or explosive gases.
- Never disassemble or modify this product.
- EEPROM is adopted to this product. It is not possible to conduct teaching 100 thousand times or more, because of the EEPROM's lifetime.

### Quick setting function

- The quick setting function makes it possible to set the content of the SET Mode (output operation, timer operation, amount of light emitted, and frequency of light emitted) simply by selecting a setting number.
- While in the RUN Mode, pressing and holding both the ON key (▲) and OFF key (▼) simultaneously for 2 seconds will switch to the quick setting function.

#### <Table of quick setting numbers>

No.	Output operation	Timer	Emission amount setting (Note)
-00-	D-ON	non	Level 3 (OFF)
-01-	D-ON	non	Level 2 (ON)
-02-	D-ON	ofd 10 ms	Level 3 (OFF)
-03-	D-ON	ofd 10 ms	Level 2 (ON)
-04-	D-ON	ofd 40 ms	Level 3 (OFF)
-05-	D-ON	ofd 40 ms	Level 2 (ON)
-06-	D-ON	ond 10 ms	Level 3 (OFF)
-07-	D-ON	ond 10 ms	Level 2 (ON)
-08-	D-ON	ond 40 ms	Level 3 (OFF)
-09-	D-ON	ond 40 ms	Level 2 (ON)
-10-	L-ON	ond 40 ms	Level 2 (ON)
-11-	L-ON	ond 40 ms	Level 3 (OFF)
-12-	L-ON	ond 10 ms	Level 2 (ON)
-13-	L-ON	ond 10 ms	Level 3 (OFF)
-14-	L-ON	ofd 40 ms	Level 2 (ON)
-15-	L-ON	ofd 40 ms	Level 3 (OFF)
-16-	L-ON	ofd 10 ms	Level 2 (ON)
-17-	L-ON	ofd 10 ms	Level 3 (OFF)
-18-	L-ON	non	Level 2 (ON)
-19-	L-ON	non	Level 3 (OFF)

Note: Until production in November 2007, OFF or ON was selectable. The emission amount of Level 2 (ON) is about 40% of that of Level 3 (OFF).

### Difference between previous model and upgraded one

- For upgraded ones (production in and after December 2007), "P" is marked near the beam-emitting inlet. Previous ones have no marking. Appearance and functions have been changed.

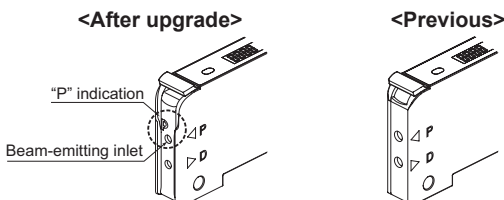

### Code setting function

- The code setting function makes it possible to set the output operation, timer operation, amount of light emitted, frequency of light emitted, ECO setting, external input, and amount of shift by selecting a code of one's choice.
- While in the RUN Mode, pressing and holding both the ON key (▲) and OFF key (▼) simultaneously for 4 seconds will switch to the code setting function.

#### <Code table>



Code	1st digit		2nd digit		3rd digit	4th digit		
	Output operation	Timer (Note 1)	Emission amount setting (Note 2)	Emission frequency FX-101□ FX-102□				
0		non	Level 3 (OFF)	0	1	Emission halt	5 %	
1		ond 10 ms		1	2	Limit teaching [+]	10 %	
2	D-ON	ond 40 ms		2	3	Limit teaching [-]	15 %	
3		ofd 10 ms		3	4	Full-auto teaching	20 %	
4		ofd 40 ms		0	1	ECO	25 %	
5		non	Level 2 (ON)	1	2	Emission halt	30 %	
6		ond 10 ms		2	3	Limit teaching [+]	35 %	
7	L-ON	ond 40 ms		3	4	Limit teaching [-]	40 %	
8		ofd 10 ms	Level 1	0	1	Full-auto teaching	45 %	
9		ofd 40 ms		1	2	ECO	50 %	
A				2	3	OFF	2-point teaching	
b			3	4	Incident light intensity test			
c			Auto	0	1	ON	2-point teaching	
d				1	2		Incident light intensity test	
e				2	3			
f			3	4				

- Notes: 1) When the present setting is out of the code setting range, "-" is shown. When "-" is selected, the set content of the digit is not changed.  
 2) Until production in November 2007, OFF or ON was selectable. The emission amount of Level 2 is about 40% of that of Level 3. The emission amount of Level 1 is about 20% of that of Level 3.  
 3) The factory setting is "0002".

**DIMENSIONS (Unit: mm in)**

The CAD data in the dimensions can be downloaded from our website.

**FX-101 □ FX-102 □ Amplifier**

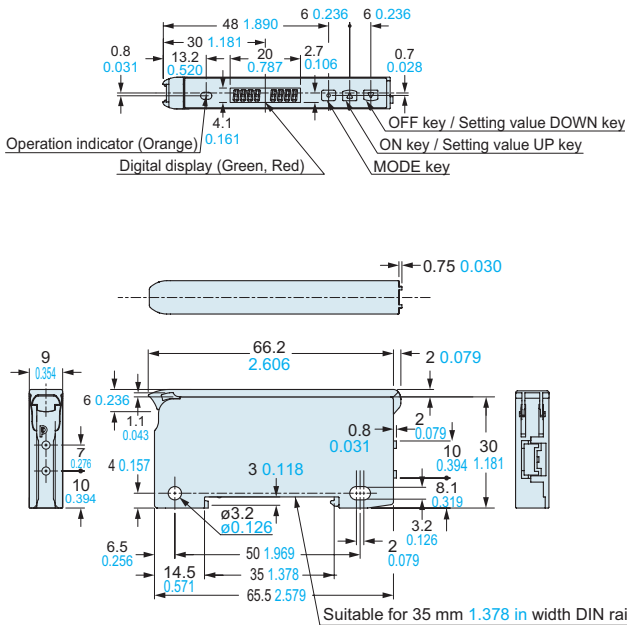

Note: The protection cover has been attached from the production at July, 2011.

**FX-101(P)-Z FX-102(P)-Z Amplifier**

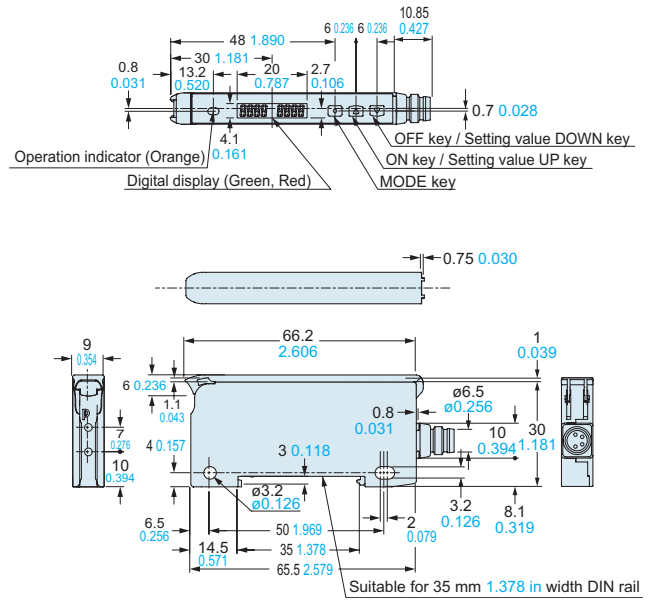

Note: The protection cover has been attached from the production at July, 2011.

**MS-DIN-4 Amplifier mounting bracket (Optional)**

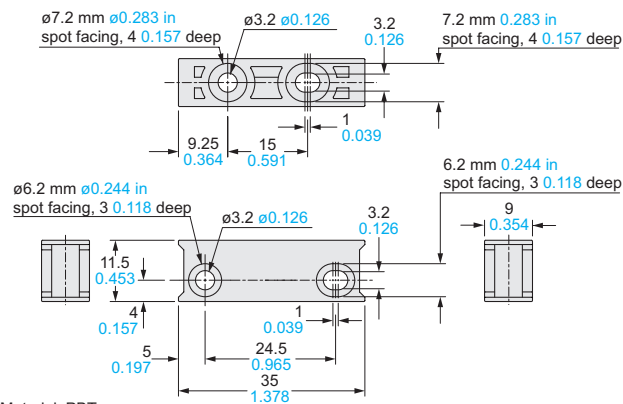

Material: PBT

**MS-DIN-E End plate (Optional)**

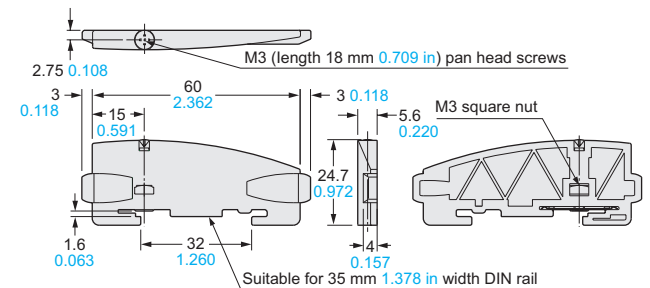

Material: Polycarbonate

**CN-14A-C □ CN-14A-R-C □ Connector attached cable (Optional)**

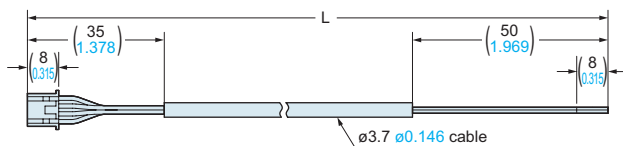

CN-14A-C2 is attached FX-101(P)-CC2 / FX-102(P)-CC2

• Length L

Model No.	Length L
CN-14A(-R)-C1	1,000 39.370
CN-14A(-R)-C2	2,000 78.740
CN-14A(-R)-C3	3,000 118.110
CN-14A(-R)-C5	5,000 196.850

FIBER SENSORS

LASER SENSORS

PHOTO-ELECTRIC SENSORS

MICRO PHOTO-ELECTRIC SENSORS

AREA SENSORS

LIGHT CURTAINS / SAFETY COMPONENTS

PRESSURE / FLOW SENSORS

INDUCTIVE PROXIMITY SENSORS

PARTICULAR USE SENSORS

SENSOR OPTIONS

SMALL WIRE-SAVING UNITS

WIRE-SAVING SYSTEMS

MEASUREMENT SENSORS

STATIC ELECTRICITY PREVENTION DEVICES

LASER MARKERS

PLC

HUMAN MACHINE INTERFACES

ENERGY CONSUMPTION VISUALIZATION COMPONENTS

FA COMPONENTS

MACHINE VISION SYSTEMS

UV CURING SYSTEMS

Selection Guide

Fibers

Fiber Amplifiers

FX-500

FX-100

FX-300

FX-410

FX-311

FX-301-F7 / FX-301-F