

Dual Channel Photologic® Encoder Detector



OPL583



Features:

- Two matched detectors with photolithographic control of relative position
- Dual Photologic® circuitry in single package provides reduced component count
- Open collector inverter output for flexibility of circuit interface
- Low cost plastic housing

Description:

OPL583 contains a monolithic integrated circuit that incorporates two independent photodiodes, two linear amplifiers, two Schmitt trigger circuits and two output transistors which are all served by a common voltage regulator. The fixed position of the two photodiodes and the matched characteristics of the two channels allow considerable design flexibility. The outputs are TTL/LSTTL compatible and can drive up to 8 TTL loads over a voltage range from 4.5 to 16 V.

Applications include linear and rotary encoders with resolutions determined by external apertures

Applications:

- Rotary and Linear encoders
- Non-contact reflective object sensor
- Assembly line automation
- Machine automation
- Machine safety
- End of travel sensor

Ordering Information				
Part Number	Photologic®	Input Power E_E (mW/cm ²) Min / Max	V _{CC} (V) Min / Max	Lead Length/ Spacing
OPL583	Dual Channel	0.05 / 0.25	4.5/16	0.50" / 0.05"

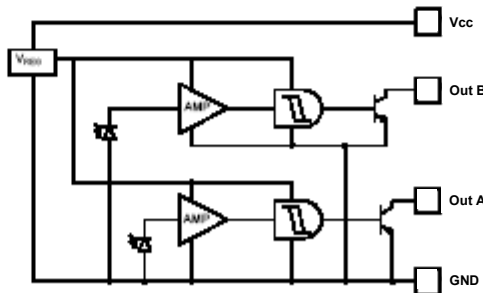

Pin #	Description
1	V _{CC}
2	Out-B
3	Out-A
4	Ground

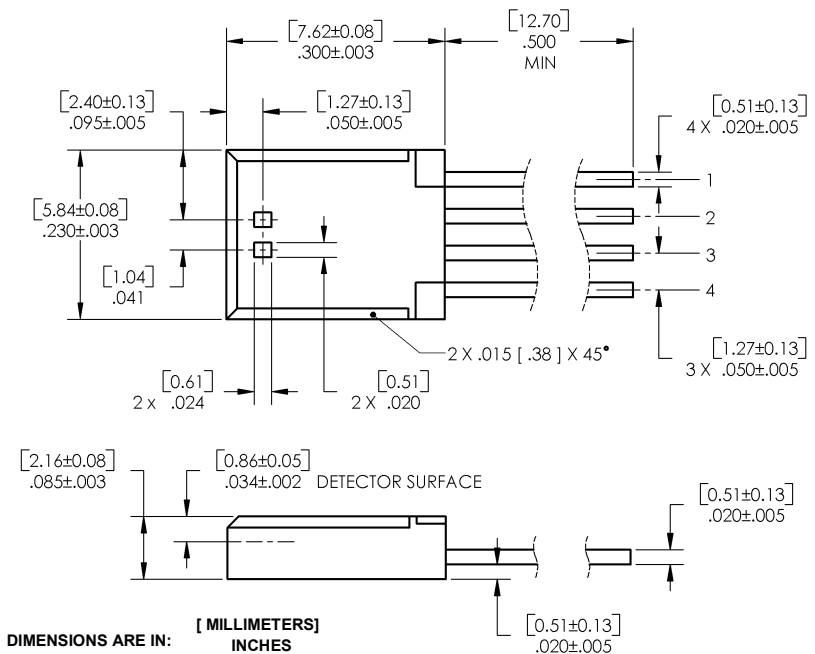

General Note
TT Electronics reserves the right to make changes in product specification without notice or liability. All information is subject to TT Electronics' own data and is considered accurate at time of going to print.

OPTEK Technology, Inc.
1645 Wallace Drive, Carrollton, TX 75006 | Ph: +1 972 323 2200
www.optekinc.com | www.ttelectronics.com

Dual Channel Photologic® Encoder Detector



OPL583

Absolute Maximum Ratings ($T_A = 25^\circ\text{C}$ unless otherwise noted)	
Operating Temperature Range	-40° C to +85° C
Storage Temperature Range	-40° C to +100° C
Lead Soldering Temperature [1/16 inch (1.6mm) from the case for 5 sec. with soldering iron]	260°C ⁽¹⁾
Output Photologic®	
Supply Voltage V_{CC}	18 V ⁽²⁾
Power Dissipation	200 mW ⁽³⁾
Duration of Output Short to V_{CC}	1 second
Voltage at Output	18 V
Low Level Output Current (sinking)	40 mA

Electrical Characteristics ($T_A = 25^\circ\text{C}$ unless otherwise noted)						
SYMBOL	PARAMETER	MIN	TYP	MAX	UNITS	TEST CONDITIONS
V_{CC}	Operating Supply Voltage ⁽⁴⁾	4.5	-	16	V	-
$E_{ET}^{(+)}$	Positive-Going Threshold Irradiance ⁽⁵⁾	0.05	0.10	0.25	mW/cm ²	-
$E_{ET}^{(+)}/E_{ET}^{(-)}$	Hysteresis Ratio	1.1	1.5	2	-	-
MATCH	Channel Match $E_{ET}^{(+A)}/E_{ET}^{(+B)}$	0.67	1	1.5	-	-
I_{CCL}	Supply Current Both Outputs Low (both photodiodes irradiated)	-	8.5	12	mA	$E_E = 0.5\text{ mW/cm}^2$ (no load on output)
I_{CCH}	Supply Current Both Outputs High (both photodiodes shaded)	-	3.5	6	mA	$E_E = 0\text{ mW/cm}^2$ (no load on output)
I_{CCM}	Supply Current Mixed Output States (one high, one low)	-	6	-	mA	$E_E = 0\text{ mW/cm}^2$ and 0.5 mW/cm^2
I_{oh}	High Level Output Current	-	1	30	μA	$E_E = 0\text{ mW/cm}^2$, $V_{OH} = 16\text{ V}$
V_{OL}	Low Level Output Voltage	-	0.21	0.4	V	$E_E = 0.5\text{ mW/cm}^2$, $I_{OL} = 12.8\text{ mA}$
T_{PHL} T_{PLH}	Propagation Delay Output High to Low Output Low to High	-	2 10	-	μs μs	$V_{CC} = 5\text{ V}$, $R_L = 360\ \Omega$ $E_E = 0$ or 0.5 mW/cm^2 , $f = 10\text{ kHz}$, D.C. = 50%
t_r t_f	Output Rise Time Output Fall Time	-	20 15	-	ns ns	-

General Note
TT Electronics reserves the right to make changes in product specification without notice or liability. All information is subject to TT Electronics' own data and is considered accurate at time of going to print.

OPTEK Technology, Inc.
1645 Wallace Drive, Carrollton, TX 75006 | Ph: +1 972 323 2200
www.optekinc.com | www.ttelectronics.com

Dual Channel Photologic® Encoder Detector



OPL583

Supply Current vs. Ambient Temperature

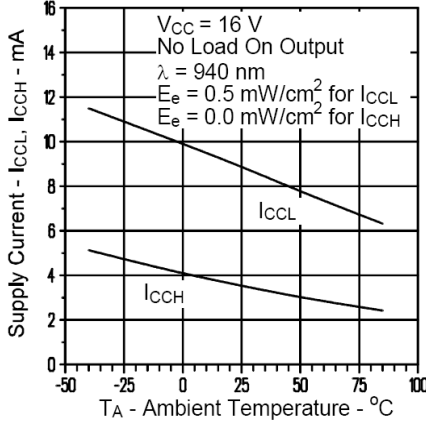

Normalized Threshold Irradiance vs. Ambient Temperature

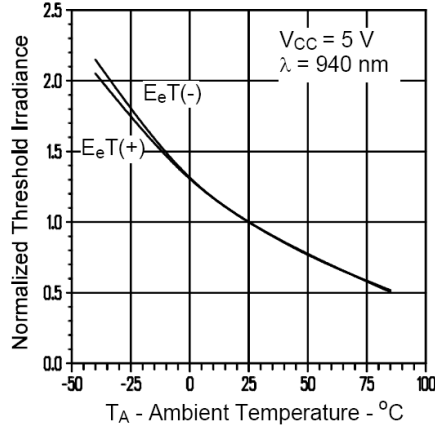

Low Level Output Voltage vs. Ambient Temperature

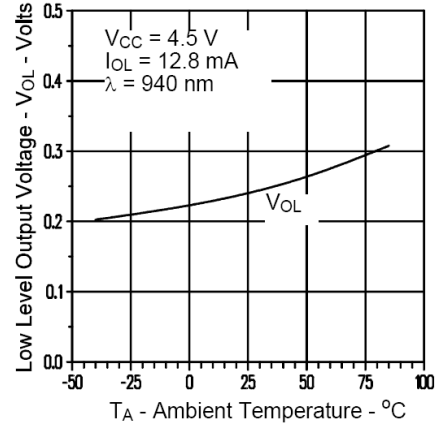

Angular Displacement from Package Mechanical Axis

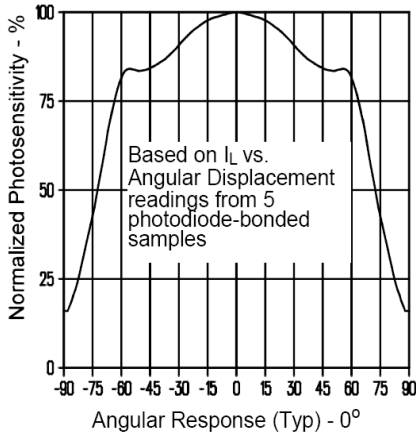

High Level Output Current vs. Ambient Temperature

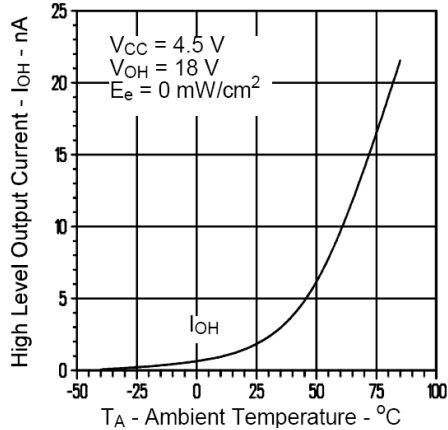

Rise, Fall Time vs. Ambient Temperature vs. Output Load

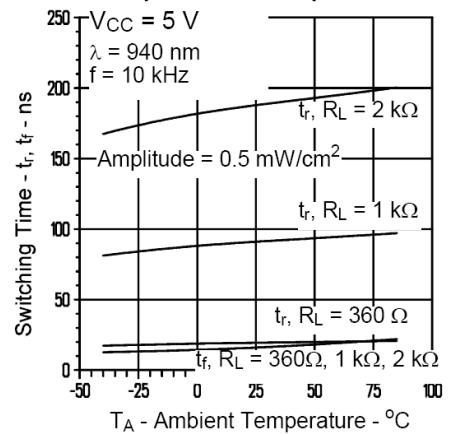

Typical Application Circuit

Propagation Delay vs. Ambient Temperature

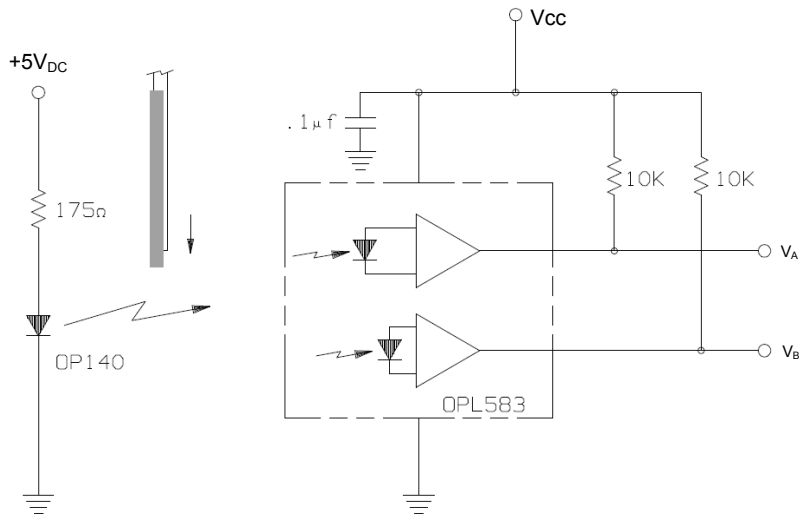
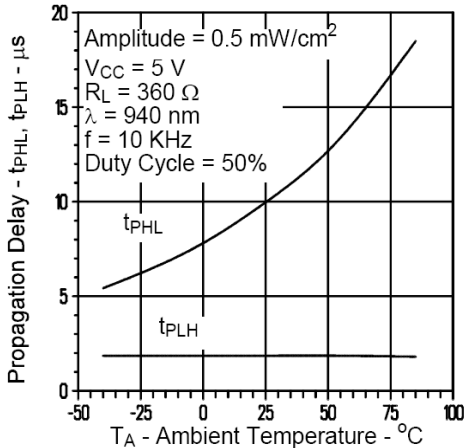

General Note
TT Electronics reserves the right to make changes in product specification without notice or liability. All information is subject to TT Electronics' own data and is considered accurate at time of going to print.

OPTeK Technology, Inc.
1645 Wallace Drive, Carrollton, TX 75006 | Ph: +1 972 323 2200
www.optekinc.com | www.ttelectronics.com