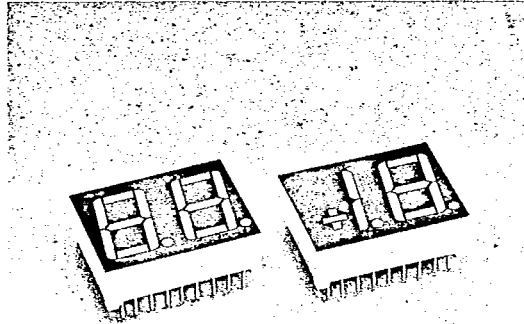

LITEON**LTD-6000 SERIES****0.56" DUAL DIGIT NUMERIC DISPLAYS**

T-41-33

FEATURES

- 0.56 INCH (14.2mm) DIGIT HEIGHT.
- CHOICE OF SIX BRIGHT COLORS-RED/BRIGHT RED/GREEN/YELLOW/ORANGE/HIGH EFFICIENCY RED.
- LOW POWER REQUIREMENT.
- EXCELLENT CHARACTERS APPEARANCE.
- CATEGORIZED FOR LUMINOUS INTENSITY.
- I.C. COMPATIBLE.
- EASY MOUNTING ON P.C. BOARD OR SOCKETS.

**DESCRIPTION**

The LTD-6000, series are 0.56 inch (14.2mm) high, dual digit displays.

The red series devices utilize LED chips which are made from GaAsP on a GaAs substrate. The bright red and green series devices utilize LED chips which are made from GaP on a transparent GaP substrate. The yellow, orange and high efficiency red series devices are utilize LED chips which are made from GaAsP on a transparent GaP substrate. Red and bright red displays have black face and red segment color. Green and yellow displays have gray face and white segment color. Orange displays have orange face and orange segment color. High efficiency red displays have red face and red segment color.

**DEVICES**

PART NO. LTD-						DESCRIPTION	INTERNAL CIRCUIT DIAGRAM
RED	BRIGHT RED	GREEN	YELLOW	ORANGE	HI-EFF. RED		
6710R	6710P	6410G	6810Y	6610E	6910HR	Common Anode, Rt. Hand Decimal	A
6730R	6730P	6430G	6830Y	6630E	6930HR	Common Anode, ±1.8 Overflow	B
6740R	6740P	6440G	6840Y	6640E	6940HR	Common Cathode, Rt. Hand Decimal	C
6750R	6750P	6450G	6850Y	6650E	6950HR	Common Cathode, ±1.8 Overflow	D

5-128

791

PACKAGE DIMENSIONS

LTD-6x10/6x30/6x40/6x50

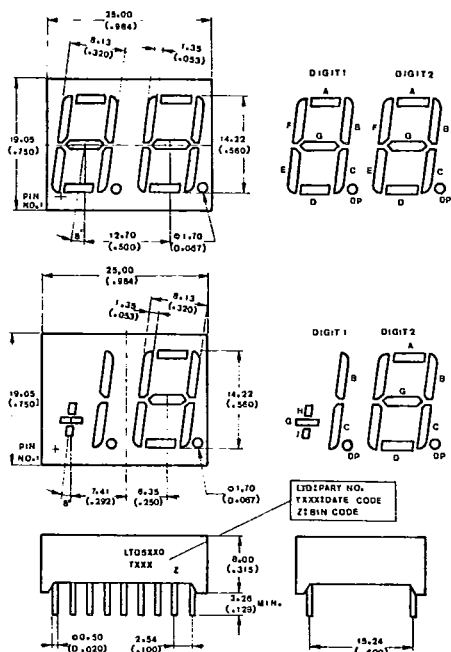

NOTE: All dimensions are in $\frac{\text{millimeters}}{\text{(inches)}}$ tolerance are:

1. Lead length (from seating plane):

$$\text{minimum value } \frac{+1.00}{-0.00} \text{ mm} \left(\frac{+0.040''}{-0.000''} \right)$$

2. $\frac{\pm 0.25 \text{ mm}}{(0.010'')}$ unless otherwise noted.

PIN CONNECTION

PIN NO.	CONNECTION			
	A. LTD-6x10	B. LTD-6x30	C. LTD-6x40	D. LTD-6x50
1	Cathode E (Digit 1)	Cathode G (Digit 1)	Anode E (Digit 1)	Anode G (Digit 1)
2	Cathode D (Digit 1)	Cathode J, H (Digit 1)	Anode D (Digit 1)	Anode J, H (Digit 1)
3	Cathode C (Digit 1)	Cathode C (Digit 1)	Anode C (Digit 1)	Anode C (Digit 1)
4	Cathode D.P. (Digit 1)	Cathode D.P. (Digit 1)	Anode D.P. (Digit 1)	Anode D.P. (Digit 1)
5	Cathode E (Digit 2)	Cathode E (Digit 2)	Anode E (Digit 2)	Anode E (Digit 2)
6	Cathode D (Digit 2)	Cathode D (Digit 2)	Anode D (Digit 2)	Anode D (Digit 2)
7	Cathode G (Digit 2)	Cathode G (Digit 2)	Anode G (Digit 2)	Anode G (Digit 2)
8	Cathode C (Digit 2)	Cathode C (Digit 2)	Anode C (Digit 2)	Anode C (Digit 2)
9	Cathode D.P. (Digit 2)	Cathode D.P. (Digit 2)	Anode D.P. (Digit 2)	Anode D.P. (Digit 2)
10	Cathode B (Digit 2)	Cathode B (Digit 2)	Anode B (Digit 2)	Anode B (Digit 2)
11	Cathode A (Digit 2)	Cathode A (Digit 2)	Anode A (Digit 2)	Anode A (Digit 2)
12	Cathode F (Digit 2)	Cathode F (Digit 2)	Anode F (Digit 2)	Anode F (Digit 2)
13	Common Anode (Digit 2)	Common Anode (Digit 2)	Common Cathode (Digit 2)	Common Cathode (Digit 2)
14	Common Anode (Digit 1)	Common Anode (Digit 1)	Common Cathode (Digit 1)	Common Cathode (Digit 1)
15	Cathode B (Digit 1)	Cathode B (Digit 1)	Anode B (Digit 1)	Anode B (Digit 1)
16	Cathode A (Digit 1)	No Connection	Anode A (Digit 1)	No Connection
17	Cathode G (Digit 1)	No Connection	Anode G (Digit 1)	No Connection
18	Cathode F (Digit 1)	No Connection	Anode F (Digit 1)	No Connection

INTERNAL CIRCUIT DIAGRAM

A. LTD-6x10

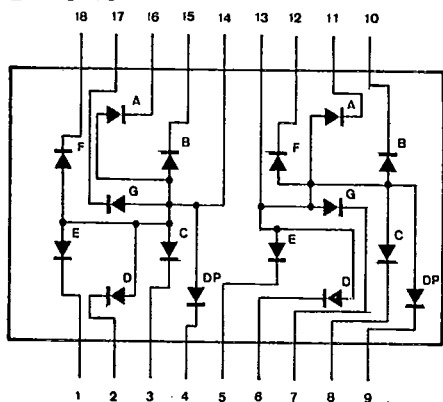

B. LTD-6x30

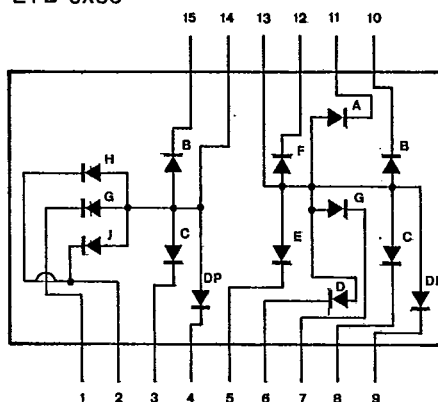

C. LTD-6x40

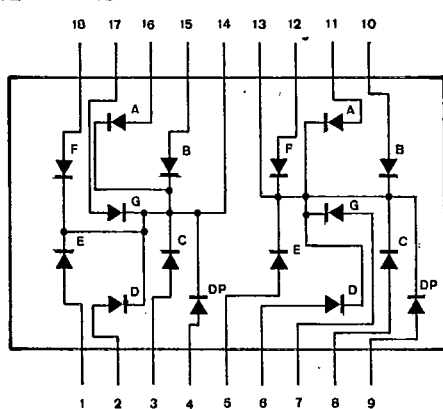

D. LTD-6x50

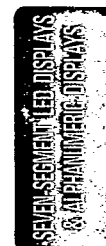
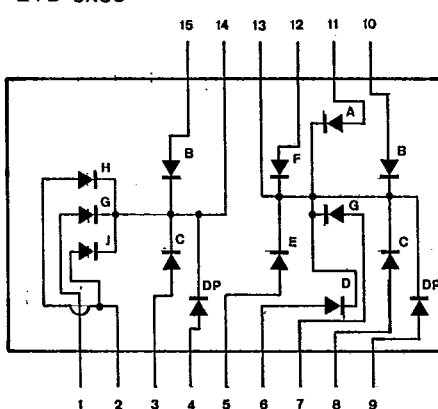

ABSOLUTE MAXIMUM RATINGS AT TA = 25°C

PARAMETER	RED	BRIGHT RED	GREEN	YELLOW	ORANGE	HI-EFF. RED	UNIT
Power Dissipation Per Segment	55	40	75	60	75	75	mW
Peak Forward Current Per Segment (1/10 Duty Cycle, 0.1ms Pulse Width)	160	60	100	80	100	100	mA
Continuous Forward Current Per Segment	25	16	25	20	25	25	mA
Derating Linear From 25°C Per Segment	0.3	0.18	0.3	0.24	0.3	0.3	mA/°C
Reverse Voltage Per Segment	5	5	5	5	5	5	V
Operating Temperature Range	-25°C to +85°C						
Storage Temperature Range	-25°C to +85°C						
Solder Temperature 1/16 inch Below Seating Plane for 3 Seconds at 260°C							

**ELECTRICAL/OPTICAL CHARACTERISTICS AT TA = 25°C
LTD-6700R SERIES**

PARAMETER	SYMBOL	MIN.	TYP.	MAX.	UNIT	TEST CONDITION
Average Luminous Intensity	I_v	200	600		μcd	$I_F = 10 \text{ mA}$
Peak Emission Wavelength	λ_p		655		nm	$I_F = 20 \text{ mA}$
Spectral Line Half-Width	$\Delta\lambda$		24		nm	$I_F = 20 \text{ mA}$
Forward Voltage, any Segment	V_F		1.7	2.0	V	$I_F = 20 \text{ mA}$
Reverse Current, any Segment	I_R			100	μA	$V_R = 5 \text{ V}$
Luminous Intensity Matching Ratio	$I_v\text{-m}$			2:1		$I_F = 20 \text{ mA}$

TYPICAL ELECTRICAL/OPTICAL CHARACTERISTIC CURVES
(25°C Ambient Temperature Unless Otherwise Noted)

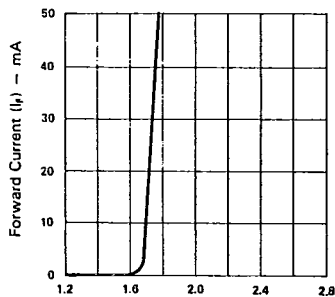

Forward Voltage (V_F) - Volts
Fig. 1 FORWARD CURRENT Vs. FORWARD VOLTAGE.

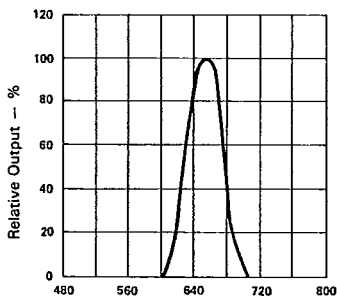

Wavelength (λ) - nm.
Fig. 2 SPECTRAL RESPONSE.

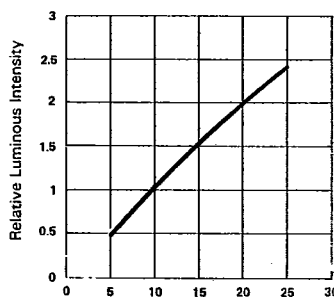

Forward Current (I_F) - mA
Fig. 3 RELATIVE LUMINOUS INTENSITY Vs. FORWARD CURRENT (PER SEGMENT).

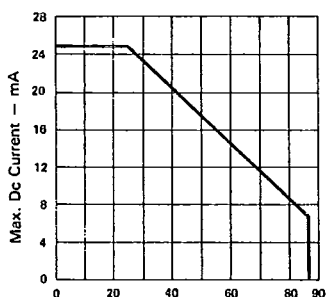

Ambient Temperature (T_A) - °C
Fig. 4 MAX. ALLOWABLE DC CURRENT PER SEG. Vs AMBIENT TEMPERATURE.

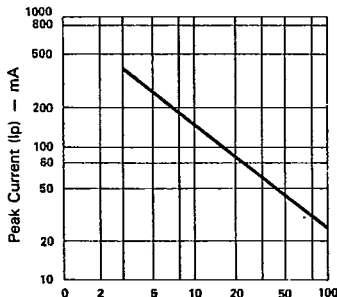

Duty Cycle %
Fig. 5 MAX. PEAK CURRENT Vs. DUTY CYCLE.% (REFRESH RATE - F = 1 KHz)

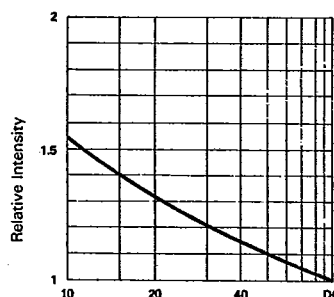

Duty Cycle %
Fig. 6 LUMINOUS INTENSITY Vs. DUTY CYCLE% (AVERAGE $I_F = 10\text{mA}$ PER SEG.)

ELECTRICAL/OPTICAL CHARACTERISTICS AT $T_A = 25^\circ\text{C}$
LTD-6700P SERIES

PARAMETER	SYMBOL	MIN.	TYP.	MAX.	UNIT	TEST CONDITION
Average Luminous Intensity	I_v	300	950		μcd	$I_F = 10\text{ mA}$
Peak Emission Wavelength	λ_p		697		nm	$I_F = 20\text{ mA}$
Spectral Line Half-Width	$\Delta\lambda$		90		nm	$I_F = 20\text{ mA}$
Forward Voltage, any Segment	V_F		2.1	2.8	V	$I_F = 20\text{ mA}$
Reverse Current, any Segment	I_R			100	μA	$V_R = 5\text{ V}$
Luminous Intensity Matching Ratio	$I_v\text{-m}$			2:1		$I_F = 20\text{ mA}$

TYPICAL ELECTRICAL/OPTICAL CHARACTERISTIC CURVES

(25°C Ambient Temperature Unless Otherwise Noted)

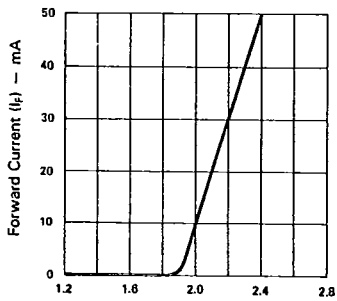

Fig. 1 FORWARD CURRENT Vs. FORWARD VOLTAGE.

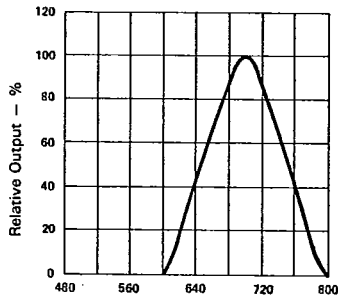

Fig. 2 SPECTRAL RESPONSE.

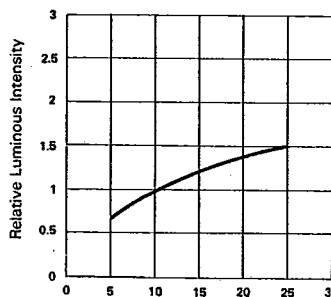

Fig. 3 RELATIVE, LUMINOUS INTENSITY Vs. FORWARD CURRENT (PER SEGMENT).

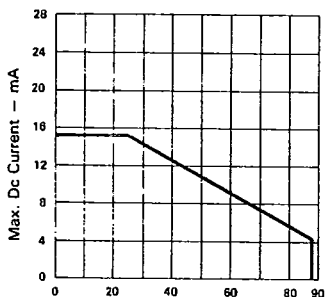

Fig. 4 MAX. ALLOWABLE DC CURRENT PER SEG. Vs AMBIENT TEMPERATURE.

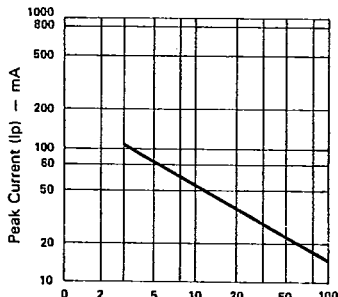
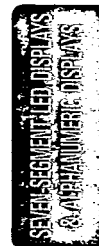

Fig. 5 MAX. PEAK CURRENT Vs. DUTY CYCLE.% (REFRESH RATE - $F = 1\text{ KHz}$)



ELECTRICAL/OPTICAL CHARACTERISTICS AT TA = 25°C
LTD-6400G SERIES

PARAMETER	SYMBOL	MIN.	TYP.	MAX.	UNIT	TEST CONDITION
Average Luminous Intensity	I_v	800	2400		μcd	$I_F = 10 \text{ mA}$
Peak Emission Wavelength	λ_p		565		nm	$I_F = 20 \text{ mA}$
Spectral Line Half-Width	$\Delta\lambda$		30		nm	$I_F = 20 \text{ mA}$
Forward Voltage, any Segment	V_F		2.1	2.8	V	$I_F = 20 \text{ mA}$
Reverse Current, any Segment	I_R			100	μA	$V_R = 5 \text{ V}$
Luminous Intensity Matching Ratio	I_{v-m}			2:1		$I_F = 20 \text{ mA}$

TYPICAL ELECTRICAL/OPTICAL CHARACTERISTIC CURVES

(25°C Ambient Temperature Unless Otherwise Noted)

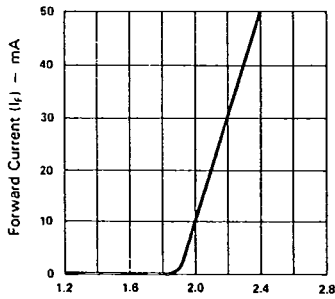

Forward Voltage (V_f) - Volts
 Fig. 1 FORWARD CURRENT Vs. FORWARD VOLTAGE.

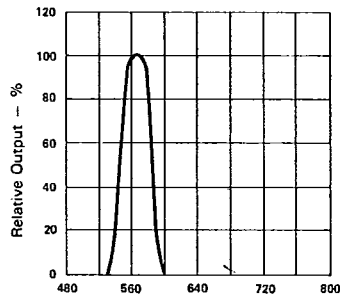

Wavelength (λ) - nm.
 Fig. 2 SPECTRAL RESPONSE.

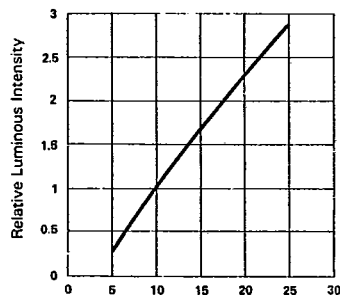

Forward Current (I_f) - mA
 Fig. 3 RELATIVE LUMINOUS INTENSITY Vs. FORWARD CURRENT (PER SEGMENT).

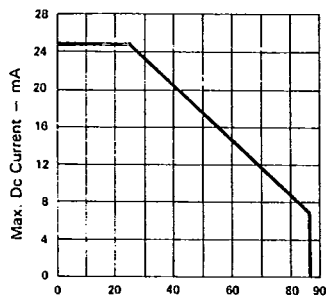

Ambient Temperature (T_a) - °C
 Fig. 4 MAX. ALLOWABLE DC CURRENT PER SEG. Vs AMBIENT TEMPERATURE.

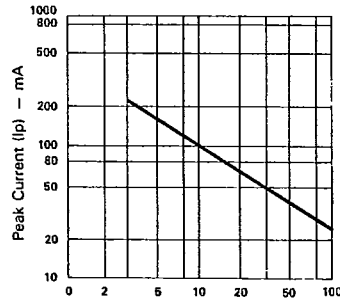

Duty Cycle %
 Fig. 5 MAX. PEAK CURRENT Vs. DUTY CYCLE.% (REFRESH RATE - F = 1 KHz)

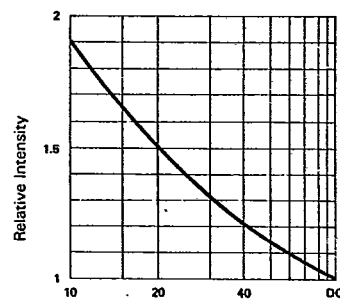

Duty Cycle %
 Fig. 6 LUMINOUS INTENSITY Vs. DUTY CYCLE% (AVERAGE $I_f = 10\text{mA}$ PER SEG.)

**ELECTRICAL/OPTICAL CHARACTERISTICS AT TA = 25°C
LTD-6800Y SERIES**

PARAMETER	SYMBOL	MIN.	TYP.	MAX.	UNIT	TEST CONDITION
Average Luminous Intensity	I_v	800	2400		μcd	$I_F = 10 \text{ mA}$
Peak Emission Wavelength	λ_p		585		nm	$I_F = 20 \text{ mA}$
Spectral Line Half-Width	$\Delta\lambda$		35		nm	$I_F = 20 \text{ mA}$
Forward Voltage, any Segment	V_F		2.1	2.8	V	$I_F = 20 \text{ mA}$
Reverse Current, any Segment	I_R			100	μA	$V_R = 5 \text{ V}$
Luminous Intensity Matching Ratio	$I_v\text{-m}$			2:1		$I_F = 20 \text{ mA}$

TYPICAL ELECTRICAL/OPTICAL CHARACTERISTIC CURVES

(25°C Ambient Temperature Unless Otherwise Noted)

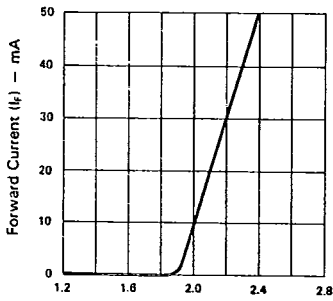

Fig. 1 FORWARD CURRENT Vs. FORWARD VOLTAGE.

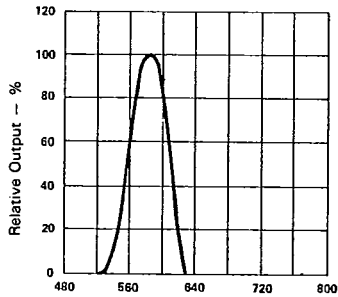

Fig. 2 SPECTRAL RESPONSE.

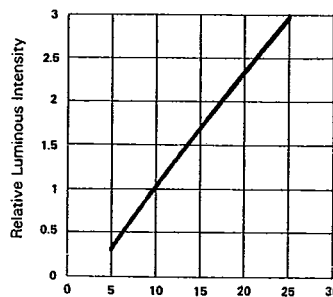

Fig. 3 RELATIVE LUMINOUS INTENSITY Vs. FORWARD CURRENT (PER SEGMENT).

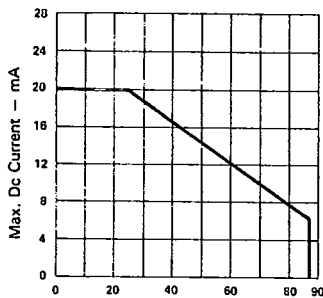

Fig. 4 MAX. ALLOWABLE DC CURRENT PER SEG. Vs AMBIENT TEMPERATURE.

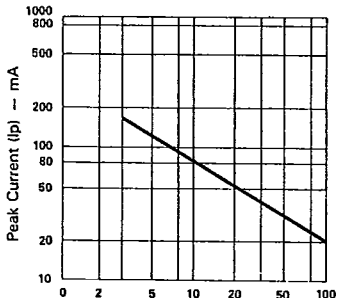

Fig. 5 MAX. PEAK CURRENT Vs. DUTY CYCLE.% (REFRESH RATE - F = 1 KHz)

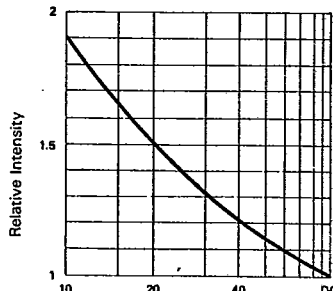

Fig. 6 LUMINOUS INTENSITY Vs. DUTY CYCLE% (AVERAGE $I_F = 10\text{mA PER SEG.}$)

SEMI-SEGMENTED DISPLAYS
& ANCHOMERIC DISPLAYS

ELECTRICAL/OPTICAL CHARACTERISTICS AT TA = 25°C
LTD-6600E SERIES

PARAMETER	SYMBOL	MIN.	TYP.	MAX.	UNIT	TEST CONDITION
Average Luminous Intensity	I_v	800	2400		μcd	$I_F = 10 \text{ mA}$
Peak Emission Wavelength	λ_p		630		nm	$I_F = 20 \text{ mA}$
Spectral Line Half-Width	$\Delta\lambda$		40		nm	$I_F = 20 \text{ mA}$
Forward Voltage, any Segment	V_F		2.1	2.8	V	$I_F = 20 \text{ mA}$
Reverse Current, any Segment	I_R			100	μA	$V_R = 5 \text{ V}$
Luminous Intensity Matching Ratio	$I_v\text{-m}$			2:1		$I_F = 20 \text{ mA}$

TYPICAL ELECTRICAL/OPTICAL CHARACTERISTIC CURVES

(25°C Ambient Temperature Unless Otherwise Noted)

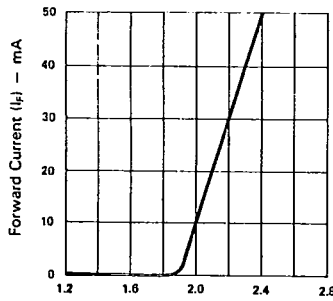

Fig. 1 FORWARD CURRENT Vs. FORWARD VOLTAGE.

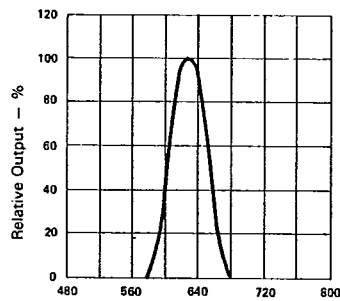

Fig. 2 SPECTRAL RESPONSE.

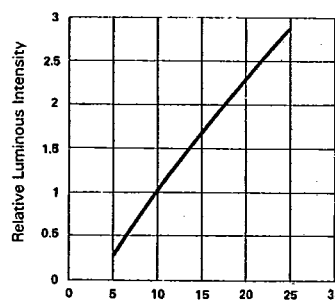

Fig. 3 RELATIVE, LUMINOUS INTENSITY Vs. FORWARD CURRENT (PER SEGMENT).

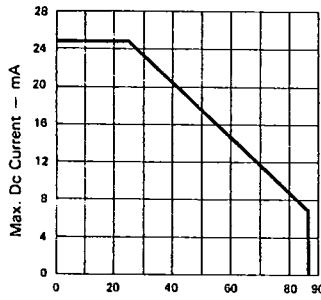

Fig. 4 MAX. ALLOWABLE DC CURRENT PER SEG. Vs AMBIENT TEMPERATURE.

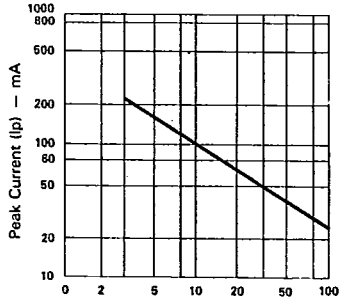

Fig. 5 MAX. PEAK CURRENT Vs. DUTY CYCLE.% (REFRESH RATE - F = 1 KHz)

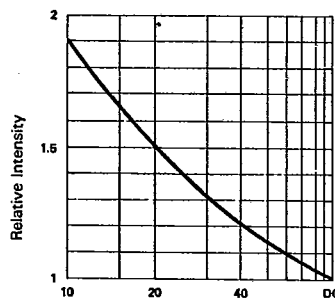

Fig. 6 LUMINOUS INTENSITY Vs. DUTY CYCLE% (AVERAGE $I_f = 10\text{mA}$ PER SEG.)

ELECTRICAL/OPTICAL CHARACTERISTICS AT $T_A = 25^\circ\text{C}$
LTD-6900HR SERIES

PARAMETER	SYMBOL	MIN.	TYP.	MAX.	UNIT	TEST CONDITION
Average Luminous Intensity	I_v	800	2400		μcd	$I_F = 10\text{ mA}$
Peak Emission Wavelength	λ_p		635		nm	$I_F = 20\text{ mA}$
Spectral Line Half-Width	$\Delta\lambda$		40		nm	$I_F = 20\text{ mA}$
Forward Voltage, any Segment or D.P.	V_F		2.1	2.8	V	$I_F = 20\text{ mA}$
Reverse Current, any Segment or D.P.	I_R			100	μA	$V_R = 5\text{ V}$
Luminous Intensity Matching Ratio	$I_v\text{-m}$			2:1		$I_F = 20\text{ mA}$

TYPICAL ELECTRICAL/OPTICAL CHARACTERISTIC CURVES

(25°C Ambient Temperature Unless Otherwise Noted)

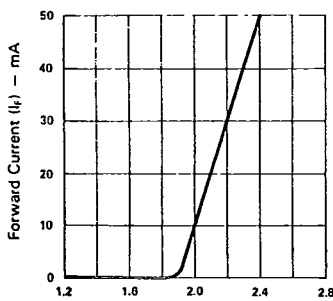

Fig. 1 FORWARD CURRENT Vs. FORWARD VOLTAGE.

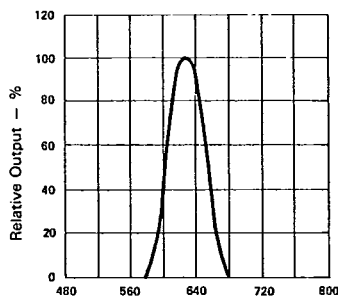

Fig. 2 SPECTRAL RESPONSE.

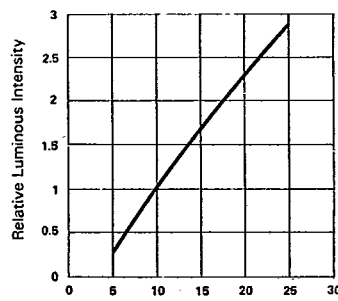

Fig. 3 RELATIVE, LUMINOUS INTENSITY Vs. FORWARD CURRENT (PER SEGMENT).

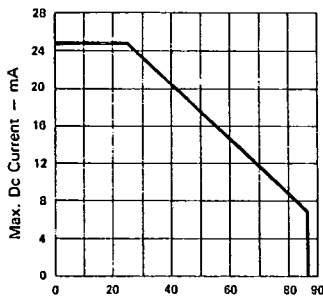

Fig. 4 MAX. ALLOWABLE DC CURRENT PER SEG. Vs AMBIENT TEMPERATURE.

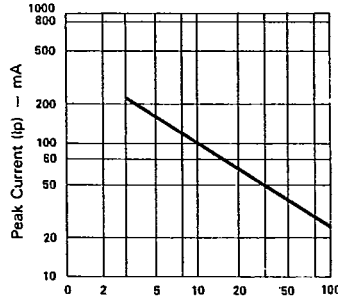

Fig. 5 MAX. PEAK CURRENT Vs. DUTY CYCLE.% (REFRESH RATE - $F = 1\text{ KHz}$)

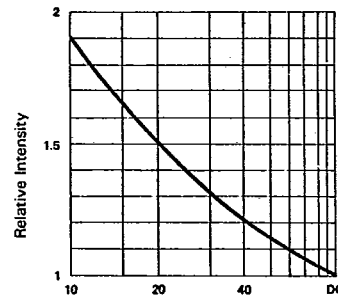
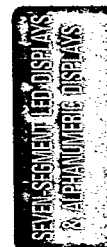

Fig. 6 LUMINOUS INTENSITY Vs. DUTY CYCLE.% (AVERAGE $I_F = 10\text{mA}$ PER SEG.)



PACKAGING

T-90-20

Reel Packaging (Axial Lead Units)

DEVICE TYPE	COMPONENT SPACE (MM) "A"	TAPE SPACE (MM) "B"	REEL DIA (MM) "D"	QUANTITY (EA)		CARTON	
				REEL	CARTON	SIZE (MM)	WEIGHT (KG)
DO-41 DO-41L	5±0.5	52.4±1.5	326~336	5000	20K	355 x 355 x 355	10.5
DO-201AD	10±0.5	52.4±1.5	326~336	1200	4.8K	355 x 355 x 355	9.0
P6(Aleg)	10±0.5	52.4±1.5	326~336	700	2.8K	355 x 355 x 355	8.8

The C dimension of Fig. 3 is between 3.17m.m. and 635mm greater than the length of the component involved.

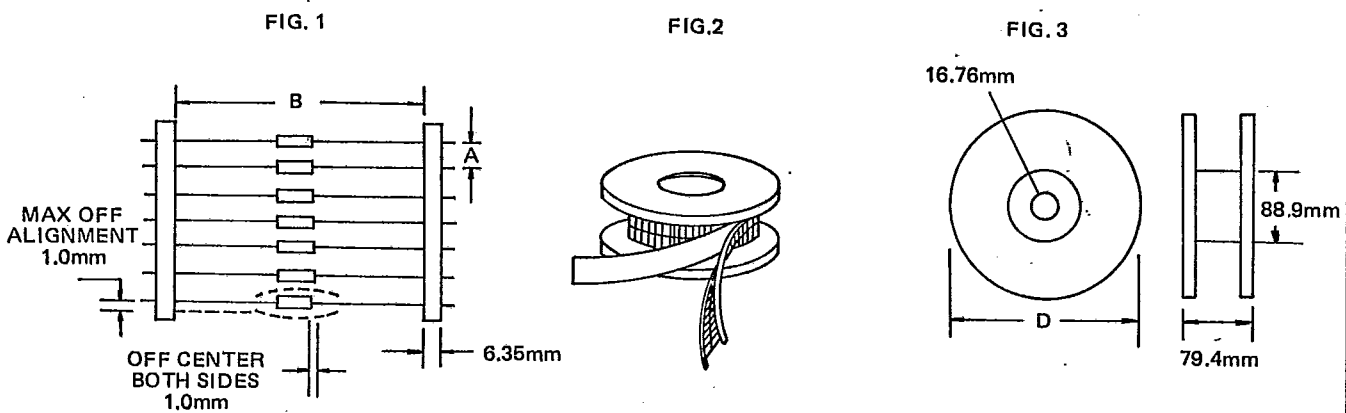

Bulk Packaging (Axial Lead Devices and Bridge Rectifiers)

DEVICE TYPE	PACKAGING SIZE (MM)		QUANTITY (EA)		APPROX GROSS WEIGHT (KG)	
	BOX	CARTON	BOX	CARTON	BOX	CARTON
DO-41 DO-41L	196 x 84 x 20	450 x 210 x 250	1000	50K	0.38	20
DO-201AD	305 x 93 x 59	355 x 355 x 355	1000	20K	1.35	28
P6(Aleg)	305 x 93 x 59	355 x 355 x 355	500	10K	1.2	24.5
PBM	357 x 125 x 60	530 x 360 x 340	1000	20K	1.5	32.3
PBDF	495 x 155 x 145	500 x 325 x 305	5000	20K	5.1	21.5
PBP	357 x 125 x 60	530 x 360 x 340	500	10K	1.5	31.5
PBL	375 x 220 x 155	470 x 385 x 455	1000	5K	5.7	30.5
PBPC-6	357 x 125 x 60	560 x 360 x 340	250	5K	1.1	22
PBPC-8	357 x 125 x 60	560 x 360 x 340	250	5K	1.7	35
KBPC	375 x 220 x 365	470 x 390 x 385	500	1K	15.1	31.5
KBPC-W	375 x 220 x 365	470 x 390 x 385	500	1K	14.5	30.0

AMMO BOX PACKAGING

BOX SIZE

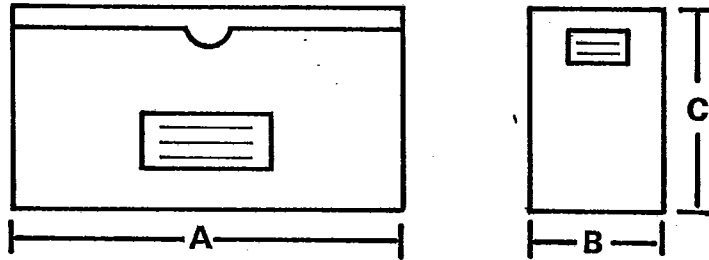

Unit:m. m.

Packaging	Products Outline	Dimension *A*	Dimension *B*	Dimension *C*	Q'ty per BOX
26MM Horizontal Ammo Pack	DO-41 DO-41L(0.6mm Lead)	255	50	95	3K
					3K
52MM Horizontal Ammo Pack	DO-41and DO-41L DO 201AD	250	75	92	3K
					0.8K

CARTON SIZE

Unit:m. m.

Packaging	Products Outline	length	Width	High	Q'ty Per Carton
26MM Horizontal Ammo Pack	DO-41 DO-41L(0.6mm Lead)	330	310	268	42K
					48K
52MM Horizontal Ammo Pack	DO-41and DO-41L DO 201AD	355	355	340	12K

PREFORMED LEAD DRAWING

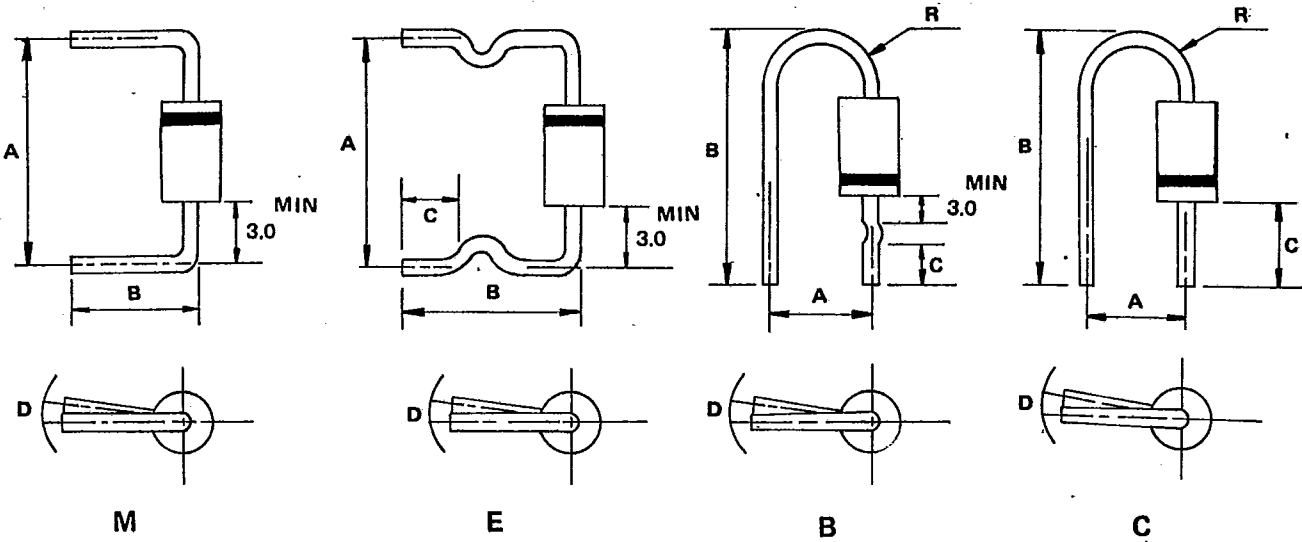

Case type	Preformed type	A (mm)		B (mm)		C (mm)		D (mm)		R (mm)	
		range	tolerance	range	tolerance	range	tolerance	range	tolerance	range	tolerance
D041	M	9.0-20.0	1.0	8.0-22.0	±0.5	-	-	1.5	max	-	-
	E	11.0-20.0	±1.0	11.0-16.0	±1.0	4.0-5.0	±0.5	1.5	max	-	-
	B	7.5	±0.5	19.0-22.0	±0.5	7.5	±0.5	1.5	max	2.5-4.0	Typ
	C	4.5	±0.8	18.0-19.0	±0.5	9.0	±0.5	1.5	max	2.5-4.0	Typ
D0201AD	M	15.0-20.0	±1.0	8.0-22.0	±1.0	-	-	2.0	max	-	-
	E	15.0-20.0	±1.0	10.0-22.0	±1.0	3.0-15.0	±0.5	2.0	max	-	-
P6(Aleg)	M	15.0-20.0	±1.0	8.0-22.0	±1.0	-	-	2.0	max	-	-