

# AMMP-6222

## 7 to 21 GHz GaAs High Linearity LNA in SMT Package

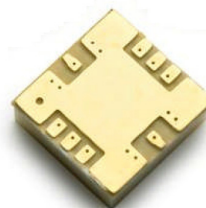

### Data Sheet



#### Description

Avago Technologies' AMMP-6222 is an easy-to-use broadband, high gain, high linearity Low Noise Amplifier in a surface mount package. The wide band and unconditionally stable performance makes this MMIC ideal as a primary or sub-sequential low noise block or a transmitter or LO driver. The MMIC has 3 gain stages and a selectable pin to switch between low and high current, corresponding with low and high output power and linearity. In the high current, high output power state, it requires a 4V, 120mA supply. In the low current, low output power state, the supply is reduced to 4V, 95mA. Since this MMIC covers several bands, it can reduce part inventory and increase volume purchase options. The MMIC is fabricated using PHEMT technology. The surface mount package eliminates the need of "chip & wire" assembly for lower cost. This MMIC is fully SMT compatible with backside grounding and I/Os.

#### Package Diagram

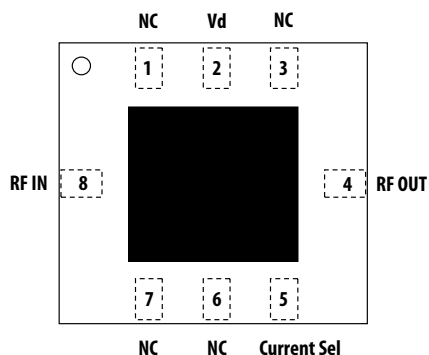

Note:  
1. This MMIC uses depletion mode pHEMT devices.

#### Features

- Surface Mount Package, 5.0 x 5.0 x 1.25 mm
- Single Positive Bias Pin
- Selectable Output Power / Linearity
- No Negative Gate Bias

#### Specifications (Vdd = 4.0V, Idd = 120mA)

- RF Frequencies: 7 - 21 GHz
- High Output IP3: 29dBm
- High Small-Signal Gain: 24dB
- Typical Noise Figure: 2.3dB
- Input, Output Match: -10dB

#### Applications

- Microwave Radio systems
- Satellite VSAT, DBS Up/Down Link
- LMDS & Pt-Pt mmW Long Haul
- Broadband Wireless Access (including 802.16 and 802.20 WiMax)
- WLL and MMDS loops

#### Functional Block Diagram

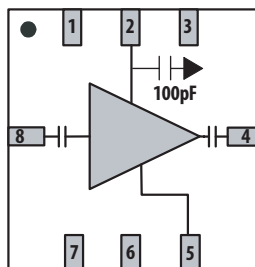

Pin	Function
1	NC
2	Vd
3	NC
4	RFout
5	Current Sel
6	NC
7	NC
8	RFin

Top view  
Package base: GND



**Attention: Observe precautions for handling electrostatic sensitive devices.**  
ESD Machine Model (Class A) = 60V  
ESD Human Body Model (Class 0) = 150V  
Refer to Avago Application Note A004R: Electrostatic Discharge, Damage and Control.

Note: MSL Rating = Level 2A

## Electrical Specifications

1. Small/Large -signal data measured in a fully de-embedded test fixture form TA = 25°C.
2. Pre-assembly into package performance verified 100% on-wafer per AMMC-6222 published specifications.
3. This final package part performance is verified by a functional test correlated to actual performance at one or more frequencies.
4. Specifications are derived from measurements in a 50 Ω test environment. Aspects of the amplifier performance may be improved over a more narrow bandwidth by application of additional conjugate, linearity, or low noise (Γopt) matching.
5. All tested parameters guaranteed with measurement accuracy +/-0.5dB for gain and +/-0.3dB for NF in the high output power configuration.

**Table 1. RF Electrical Characteristics**

TA=25°C, Id=120mA, Vd=4.0V, Zo=50 Ω

Parameter	High Output Power Configuration			Lower Output Power Configuration			Unit	Comment
	Min	Typical	Max	Min	Typical	Max		
Drain Current, Id		120			95		mA	
Small Signal Gain, Gain	19	24			23		dB	Test frequency = 8, 14, 18 GHz
Noise Figure into 50 Ω, NF		2.3	3.5		2.3		dB	Test frequency = 8, 14, 18 GHz
Output Power at 1dB Gain Compression, P1dB		15.5			14		dBm	
Output Power at 3dB Gain Compression, P3dB		17.5			16		dBm	
Output Third Order Intercept Point, OIP3		29			27		dBm	
Isolation, Iso		-45			-45		dB	
Input Return Loss, Rlin		-10			-10		dB	
Output Return Loss, RLout		-10			-10		dB	

**Table 2. Recommended Operating Range**

1. Ambient operational temperature TA = 25°C unless otherwise noted.
2. Channel-to-backside Thermal Resistance (Tchannel (Tc) = 34°C) as measured using infrared microscopy. Thermal Resistance at backside temperature (Tb) = 25°C calculated from measured data.

Description	Min.	Typical	Max.	Unit	Comments
Drain Supply Current, Id	80	120	160	mA	Vd = 4.5 V, Under any RF power drive and temperature
Drain Supply Voltage, Vd	3	4	5	V	

**Table 3. Thermal Properties**

Parameter	Test Conditions	Value
Thermal Resistance, $\theta_{jc}$	Ambient operational temperature $T_A = 25^\circ\text{C}$ Channel-to-backside Thermal Resistance $T_{channel}(T_c)=34^\circ\text{C}$ Thermal Resistance at backside temperature $T_b=25^\circ\text{C}$	$\theta_{jc} = 31.47^\circ\text{C/W}$

**Absolute Minimum and Maximum Ratings****Table 4. Minimum and Maximum Ratings**

Description	Min.	Max.	Unit	Comments
Drain to Ground Supply Voltage, $V_d$		5.5	V	
Drain Current, $I_d$		170	mA	
RF CW Input Power, $P_{in}$		10	dBm	CW
Channel Temperature, $T_{ch}$		+150	$^\circ\text{C}$	
Storage Temperature, $T_{stg}$	-65	+150	$^\circ\text{C}$	
Maximum Assembly Temperature, $T_{max}$		260	$^\circ\text{C}$	20 second maximum

Notes: 1. Operation in excess of any one of these conditions may result in permanent damage to this device.

## AMMP-6222 Typical Performance for High Current, High Output Power Configuration <sup>[1],[2]</sup>

( $T_A = 25^\circ\text{C}$ ,  $V_{dd}=4\text{V}$ ,  $I_{dd}=120\text{mA}$ ,  $Z_{in} = Z_{out} = 50\ \Omega$  unless noted)

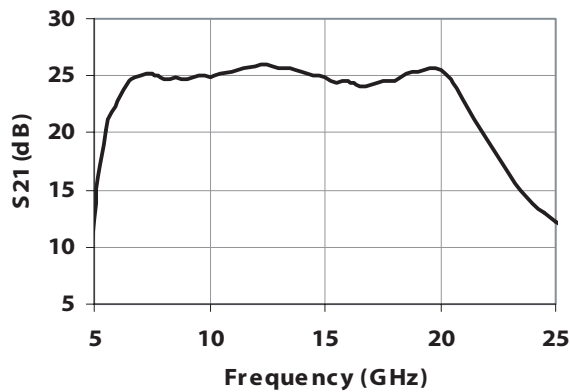

Figure 1a. Small-signal Gain

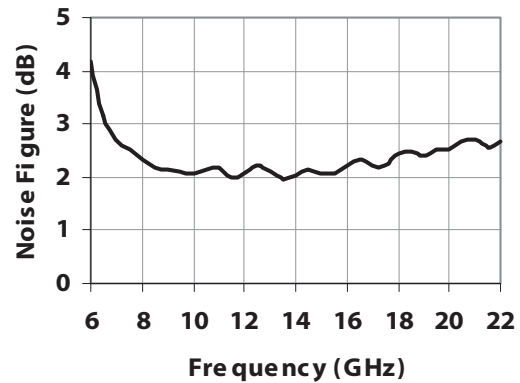

Figure 2a. Noise Figure

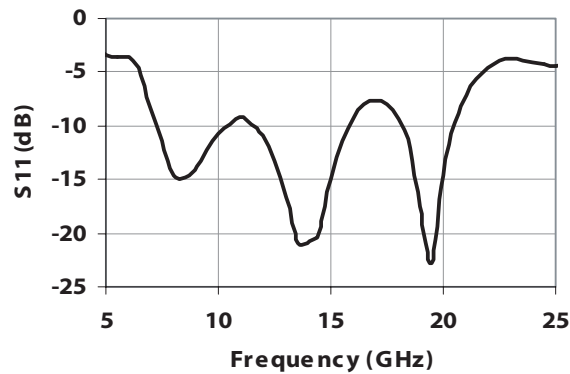

Figure 3a. Input Return Loss

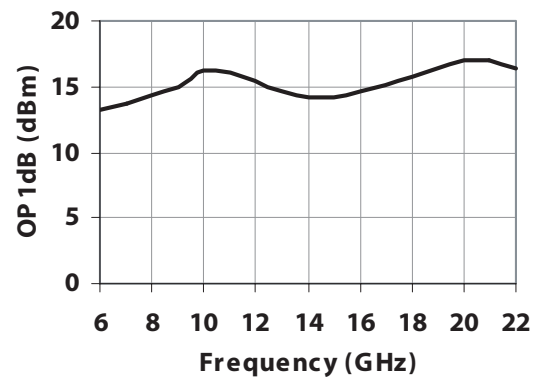

Figure 4a. Output P-1dB

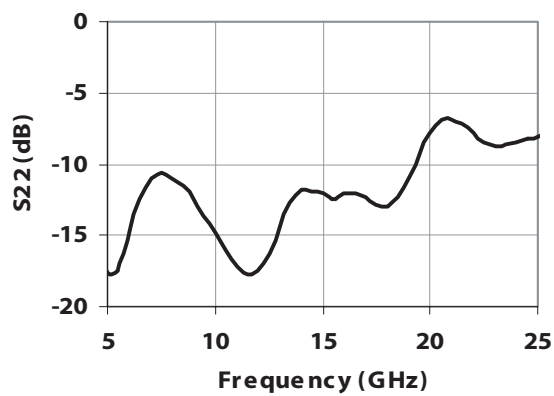

Figure 5a. Output Return Loss

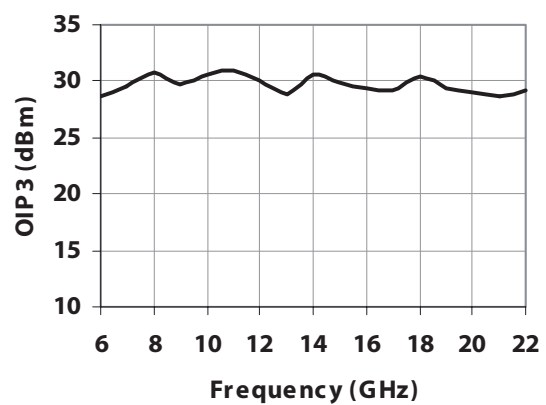

Figure 6a. Output IP3

Note:

1. S-parameters are measured with R&D Eval Board as shown in Figure 21. Board and connector effects are included in the data.
2. Noise Figure is measured with R&D Eval board as shown in Figure 21, and with a 3-dB pad at input. Board and connector losses are already de-embedded from the data.

## AMMP-6222 Typical Performance for High Current, High Output Power Configuration (Cont)

( $T_A = 25^\circ\text{C}$ ,  $V_{dd}=4\text{V}$ ,  $I_{dd}=120\text{mA}$ ,  $Z_{in} = Z_{out} = 50\ \Omega$  unless noted)

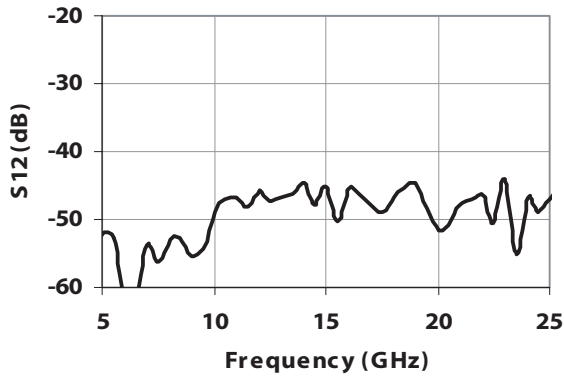

Figure 7a. Isolation

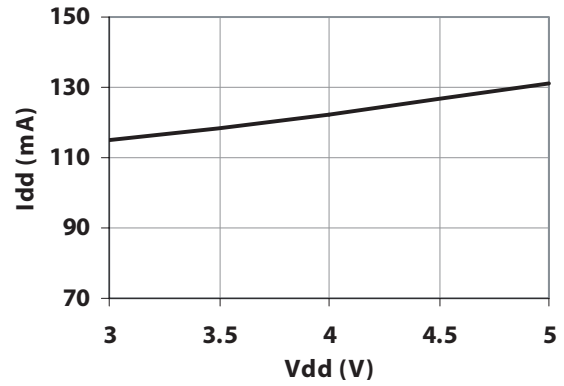

Figure 8a.  $I_{dd}$  over  $V_{dd}$

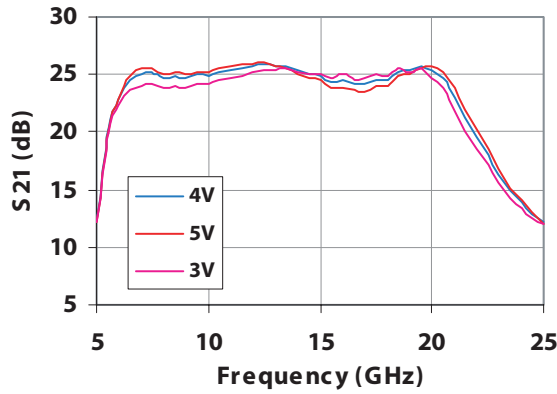

Figure 9a. Small-signal Gain Over  $V_{dd}$

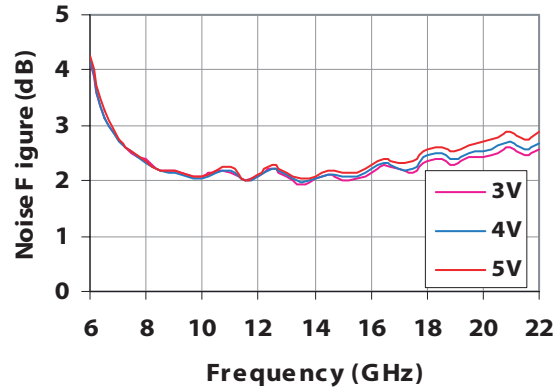

Figure 10a. Noise Figure Over  $V_{dd}$

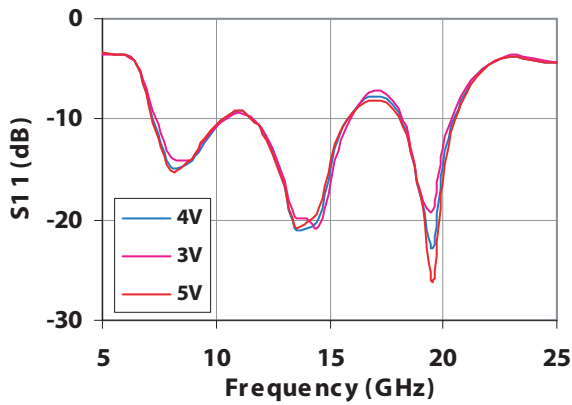

Figure 11a. Input Return Loss Over  $V_{dd}$

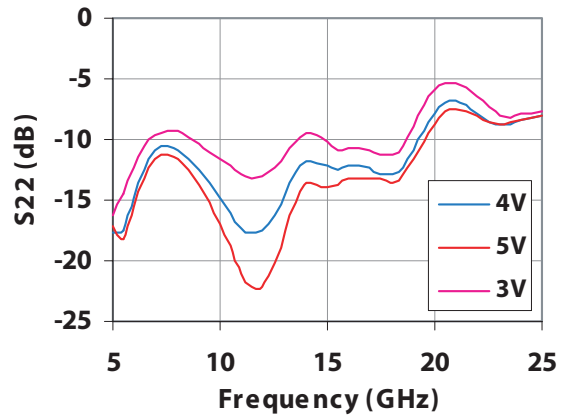

Figure 12a. Output Return Loss Over  $V_{dd}$

## AMMP-6222 Typical Performance for High Current, High Output Power Configuration (Cont)

(TA = 25°C, Vdd=4V, Idd=120mA, Zin = Zout = 50 Ω unless noted)

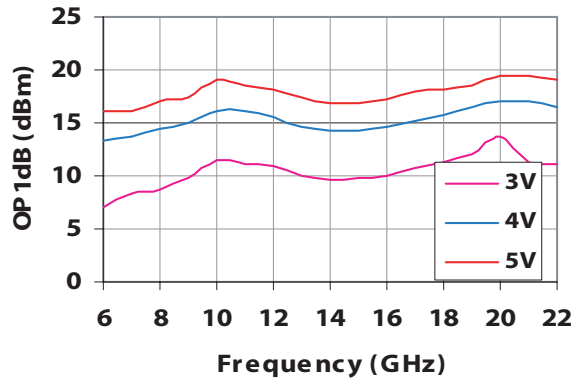

Figure 13a. Output P1dB over Vdd

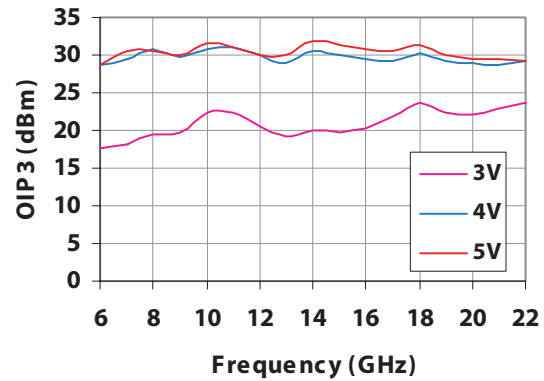

Figure 14a. Output IP3 over Vdd

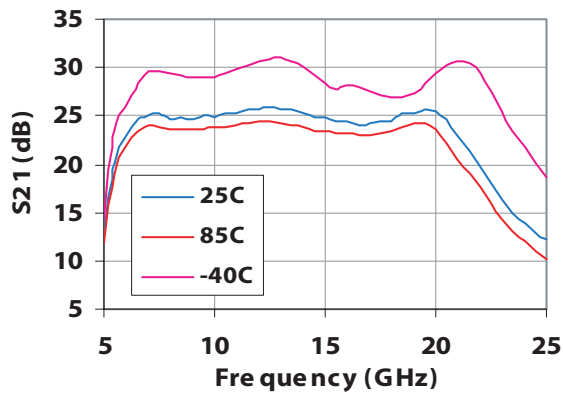

Figure 15a. Small-signal Gain Over Temp

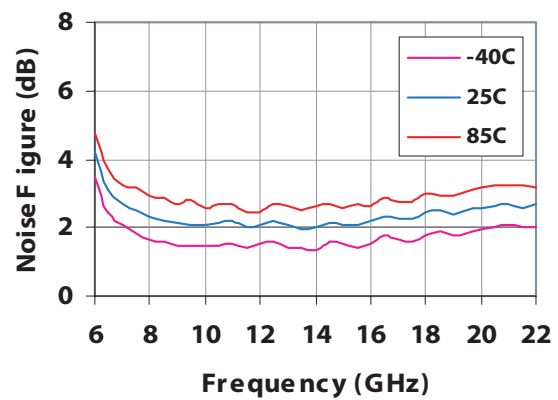

Figure 16a. Noise Figure Over Temp

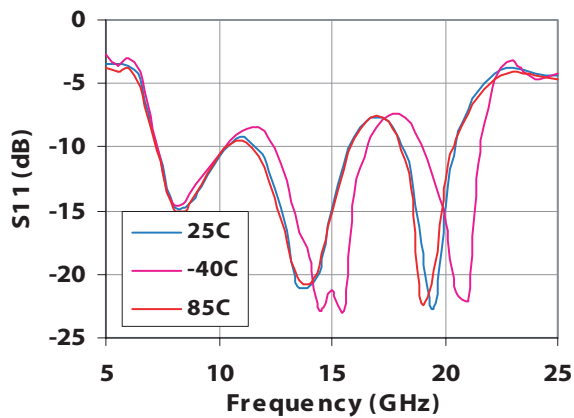

Figure 17a. Input Return Loss Over Temp

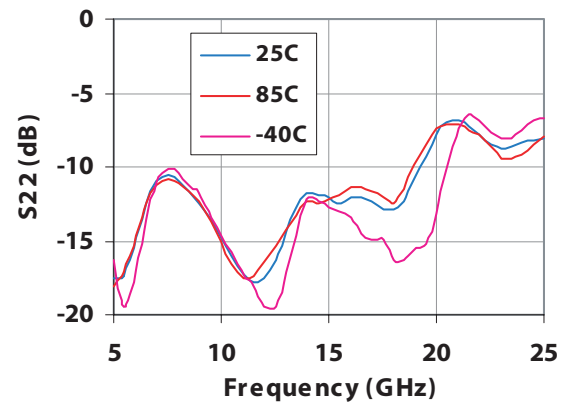

Figure 18a. Output Return Loss Over Temp

## AMMP-6222 Typical Performance for Low Current, Low Output Power Configuration <sup>[1],[2]</sup>

( $T_A = 25^\circ\text{C}$ ,  $V_{dd}=4\text{V}$ ,  $I_{dd}=95\text{mA}$ ,  $Z_{in} = Z_{out} = 50 \Omega$  unless noted)

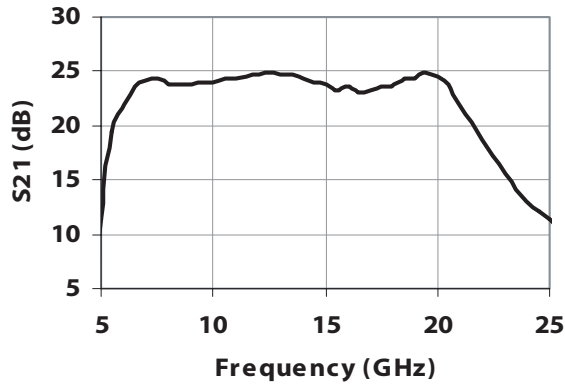

Figure 1b. Small-signal Gain

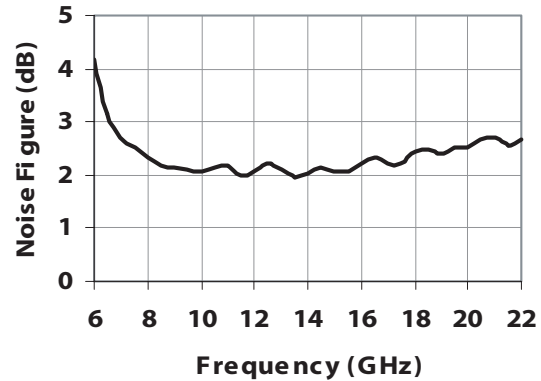

Figure 2b. Noise Figure

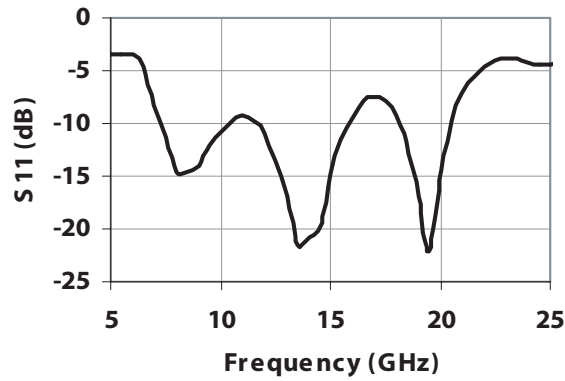

Figure 3b. Input Return Loss

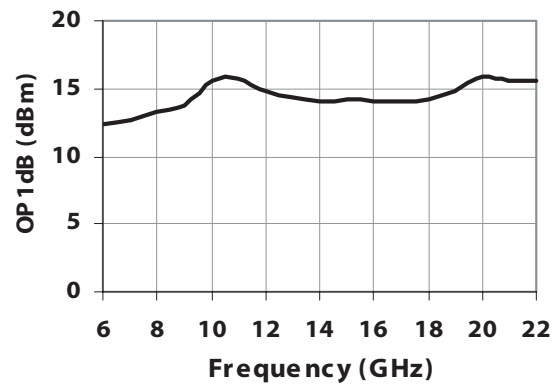

Figure 4b. Output P-1dB

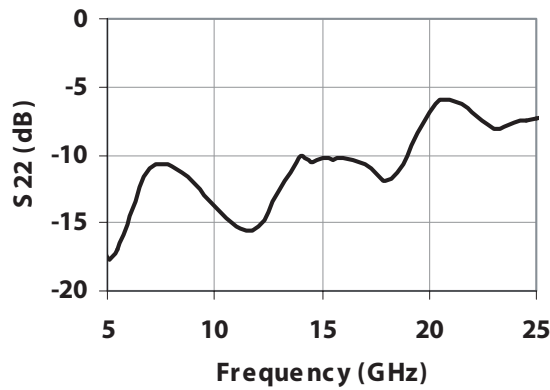

Figure 5b. Output Return Loss

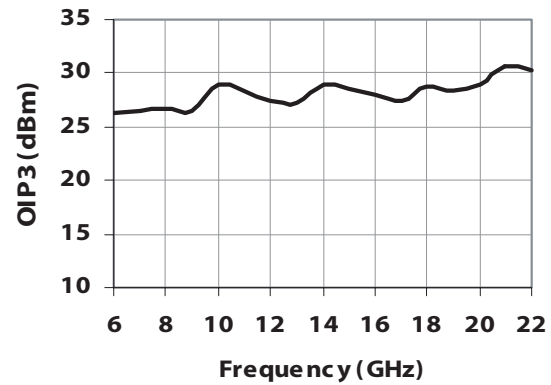

Figure 6b. Output IP3

Note:

1. S-parameters are measured with R&D Eval Board as shown in Figure 21. Board and connector effects are included in the data.
2. Noise Figure is measured with R&D Eval board as shown in Figure 21, and with a 3-dB pad at input. Board and connector losses are already de-embedded from the data

## AMMP-6222 Typical Performance for Low Current, Low Output Power Configuration (Cont)

( $T_A = 25^\circ\text{C}$ ,  $V_{dd}=4\text{V}$ ,  $I_{dd}=95\text{mA}$ ,  $Z_{in} = Z_{out} = 50 \Omega$  unless noted)

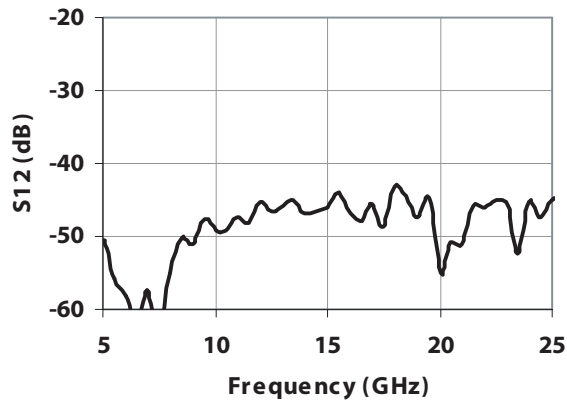

Figure 7b. Isolation

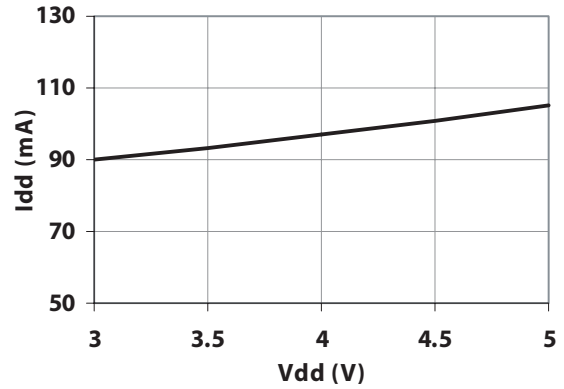

Figure 8b.  $I_{dd}$  over  $V_{dd}$

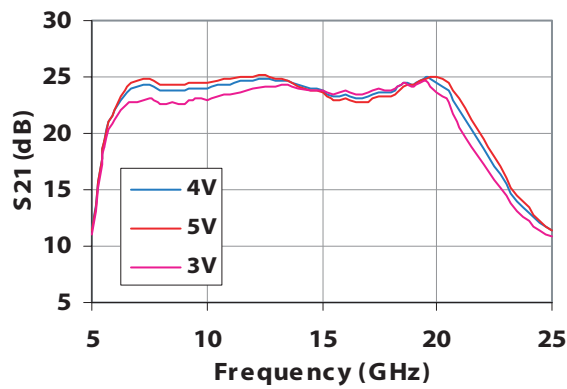

Figure 9b. Small-signal Gain Over  $V_{dd}$

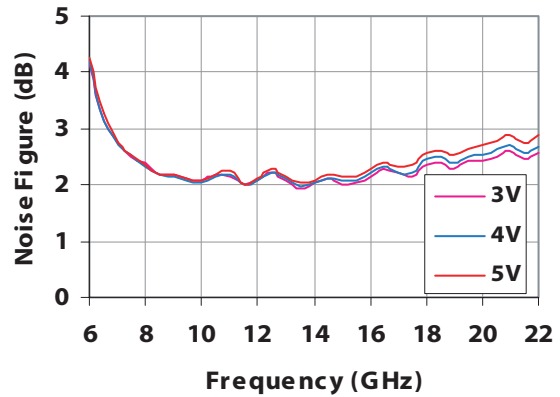

Figure 10b. Noise Figure Over  $V_{dd}$

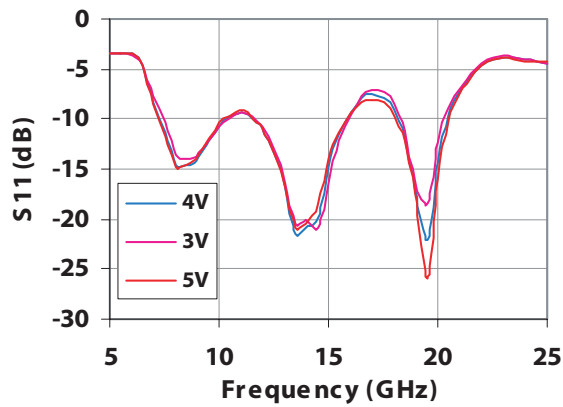

Figure 11b. Input Return Loss Over  $V_{dd}$

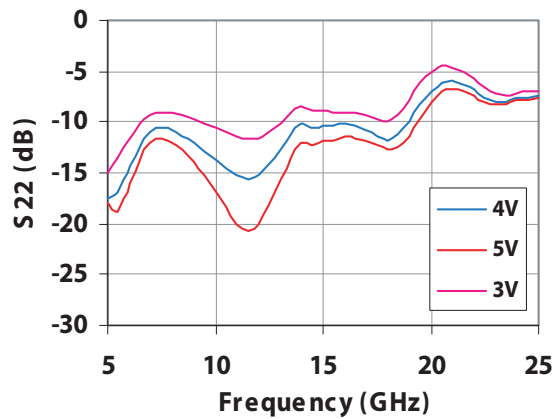

Figure 12b. Output Return Loss Over  $V_{dd}$



## AMMP-6222 Typical Performance for Low Current, Low Output Power Configuration (Cont)

( $T_A = 25^\circ\text{C}$ ,  $V_{dd}=4\text{V}$ ,  $I_{dd}=95\text{mA}$ ,  $Z_{in} = Z_{out} = 50 \Omega$  unless noted)

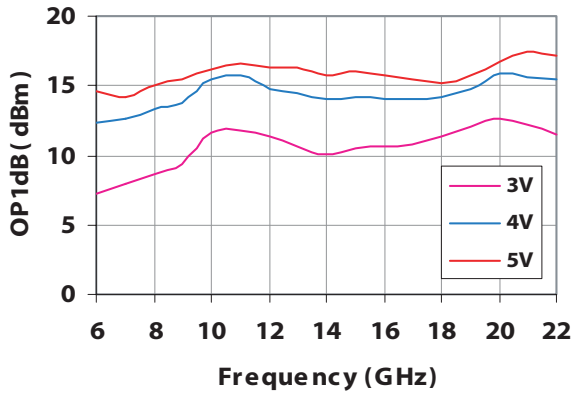

Figure 13b. Output P1dB over Vdd

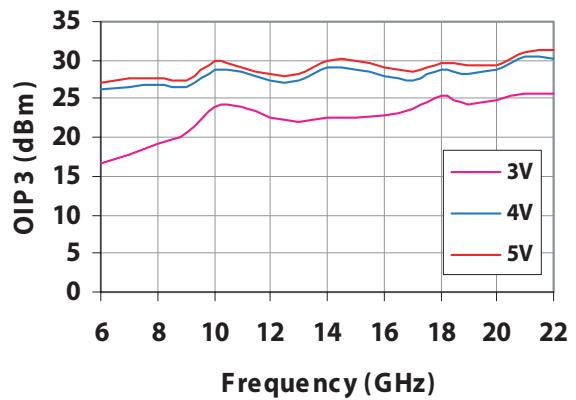

Figure 14b. Output IP3 over Vdd

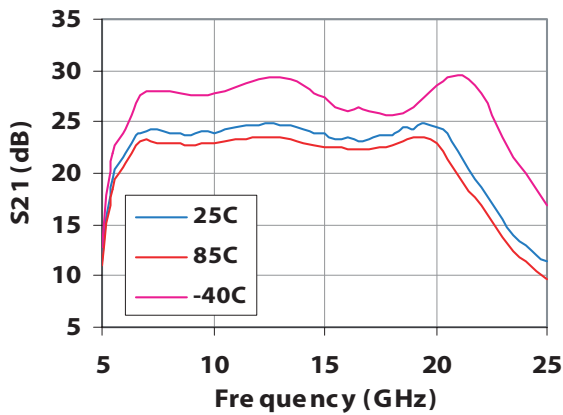

Figure 15b. Small-signal Gain Over Temp

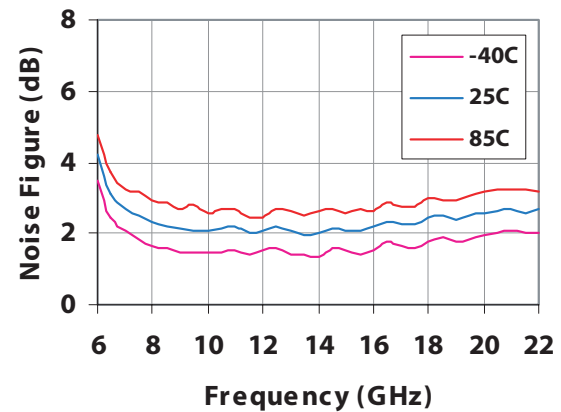

Figure 16b. Noise Figure Over Temp

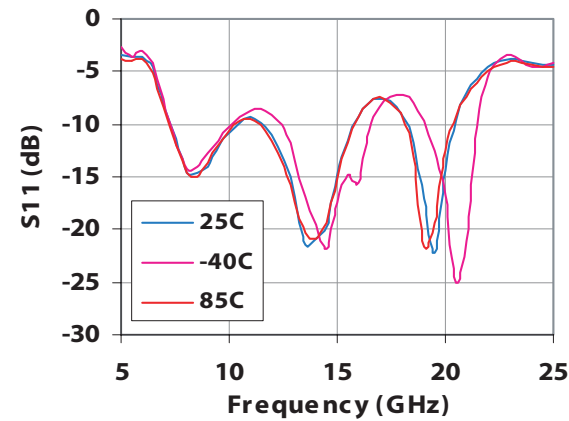

Figure 17b. Input Return Loss Over Temp

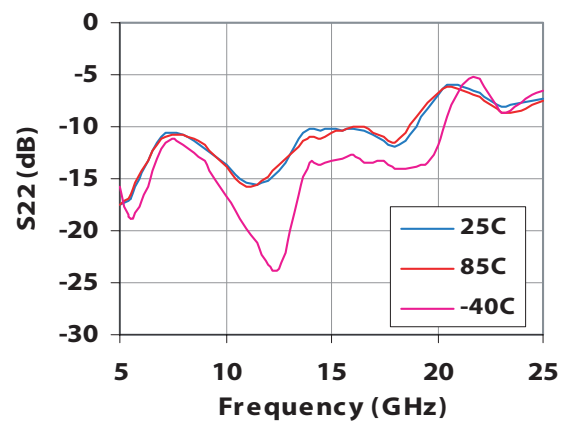

Figure 18b. Output Return Loss Over Temp

## AMMP-6222 Application and Usage

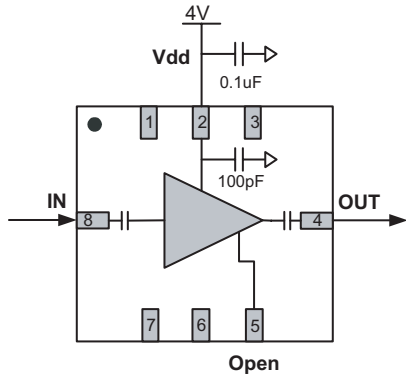

Figure 19. Low Current, Low Output Power State

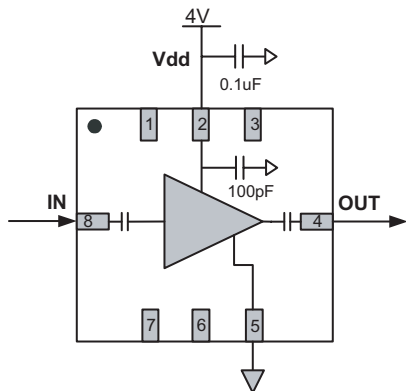

Figure 20. High Current, High Output Power State

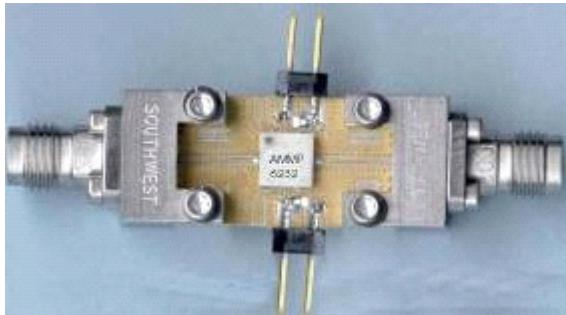

Figure 21. Evaluation/Test Board (available to qualified customer request)

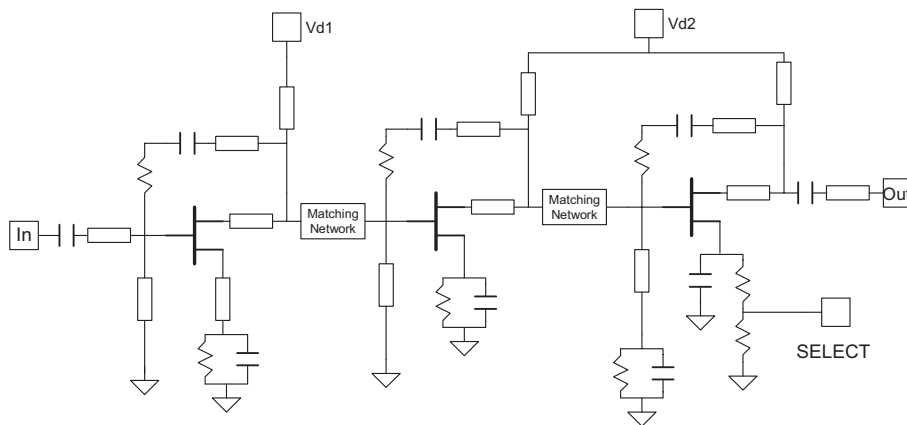

Figure 22. Simplified High Linearity LNA Schematic

## Biasing and Operation

The AMMP-6222 is normally biased with a positive drain supply connected to the VDD pin through bypass capacitor as shown in Figures 19 and 20. The recommended drain supply voltage for general usage is 4V and the corresponding drain current is approximately 120mA. It is important to have 0.1uF bypass capacitor and the capacitor should be placed as close to the component as possible. Aspects of the amplifier performance may be improved over a narrower bandwidth by application of additional conjugate, linearity, or low noise ( $T_{opt}$ ) matching.

For receiver front end low noise applications where high power and linearity are not often required, the AMMP-6222 can be set in low current state when pin # 5 is open as shown in Figure 19. In this configuration, the bias current is approximately 90mA, 95mA and 100mA for 3V, 4V and 5V respectively.

In applications where high output power and linearity are often required such as LO or transmitter drivers, the AMMP-6222 can be selected to operate at its highest output power by grounding pin # 5 as shown in Figure 20. At 5V, the amplifier can provide  $P_{sat}$  of  $\sim 20\text{dBm}$ . The bias current in this configuration is 115mA, 120mA and 125mA for 3V, 4V and 5V respectively.

Refer the Absolute Maximum Ratings table for allowed DC and thermal conditions.

## Typical Scattering Parameters

Please refer to <<http://www.avagotech.com>> for typical scattering parameters data.

## Package Dimension, PCB Layout and Tape and Reel information

Please refer to Avago Technologies Application Note 5520, AMxP-xxxx production Assembly Process (Land Pattern A).

## Ordering Information

Part Number	Devices Per Container	Container
AMMP-6222-BLKG	10	Antistatic bag
AMMP-6222-TR1G	100	7" Reel
AMMP-6222-TR2G	500	7" Reel

For product information and a complete list of distributors, please go to our web site: [www.avagotech.com](http://www.avagotech.com)

Avago, Avago Technologies, and the A logo are trademarks of Avago Technologies in the United States and other countries. Data subject to change. Copyright © 2005-2013 Avago Technologies. All rights reserved. Obsoletes AV01-0441EN AV02-0493EN - July 8, 2013

