

# 2MHz to 1.6GHz 45dB RF-Detecting Controllers and RF Detector

## General Description

The MAX9930–MAX9933 low-cost, low-power logarithmic amplifiers are designed to control RF power amplifiers (PA) and transimpedance amplifiers (TIA), and to detect RF power levels. These devices are designed to operate in the 2MHz to 1.6GHz frequency range. A typical dynamic range of 45dB makes this family of logarithmic amplifiers useful in a variety of wireless and GPON fiber video applications such as transmitter power measurement, and RSSI for terminal devices. Logarithmic amplifiers provide much wider measurement range and superior accuracy to controllers based on diode detectors. Excellent temperature stability is achieved over the full operating range of  $-40^{\circ}\text{C}$  to  $+85^{\circ}\text{C}$ .

The choice of three different input voltage ranges eliminates the need for external attenuators, thus simplifying PA control-loop design. The logarithmic amplifier is a voltage-measuring device with a typical signal range of  $-58\text{dBV}$  to  $-13\text{dBV}$  for the MAX9930/MAX9933,  $-48\text{dBV}$  to  $-3\text{dBV}$  for the MAX9931, and  $-43\text{dBV}$  to  $+2\text{dBV}$  for the MAX9932.

The MAX9930–MAX9933 require an external coupling capacitor in series with the RF input port. These devices feature a power-on delay when coming out of shutdown, holding OUT low for approximately  $2.5\mu\text{s}$  to ensure glitch-free controller output.

The MAX9930–MAX9933 family is available in an 8-pin  $\mu\text{MAX}^{\circledR}$  package. These devices consume 7mA with a 5V supply, and when powered down, the typical shutdown current is  $13\mu\text{A}$ .

## Applications

RSSI for Fiber Modules, GPON-CATV Triplexors  
Low-Frequency RF OOK and ASK Applications  
Transmitter Power Measurement and Control  
TSI for Wireless Terminal Devices  
Cellular Handsets (TDMA, CDMA, GPRS, GSM)

**Block Diagram appears at end of data sheet.**

$\mu\text{MAX}$  is a registered trademark of Maxim Integrated Products, Inc.

## Features

- ◆ Complete RF-Detecting PA Controllers (MAX9930/MAX9931/MAX9932)
- ◆ Complete RF Detector (MAX9933)
- ◆ Variety of Input Ranges  
MAX9930/MAX9933:  $-58\text{dBV}$  to  $-13\text{dBV}$   
( $-45\text{dBm}$  to  $0\text{dBm}$  for  $50\Omega$  Termination)  
MAX9931:  $-48\text{dBV}$  to  $-3\text{dBV}$   
( $-35\text{dBm}$  to  $+10\text{dBm}$  for  $50\Omega$  Termination)  
MAX9932:  $-43\text{dBV}$  to  $+2\text{dBV}$   
( $-30\text{dBm}$  to  $+15\text{dBm}$  for  $50\Omega$  Termination)
- ◆ 2MHz to 1.6GHz Frequency Range
- ◆ Temperature Stable Linear-in-dB Response
- ◆ Fast Response: 70ns 10dB Step
- ◆ 10mA Output Sourcing Capability
- ◆ Low Power: 17mW at 3V (typ)
- ◆  $13\mu\text{A}$  (typ) Shutdown Current
- ◆ Available in a Small 8-Pin  $\mu\text{MAX}$  Package

## Ordering Information

PART	TEMP RANGE	PIN-PACKAGE
MAX9930EUA+T	$-40^{\circ}\text{C}$ to $+85^{\circ}\text{C}$	8 $\mu\text{MAX}$ -8
MAX9931EUA+T	$-40^{\circ}\text{C}$ to $+85^{\circ}\text{C}$	8 $\mu\text{MAX}$ -8
MAX9932EUA+T	$-40^{\circ}\text{C}$ to $+85^{\circ}\text{C}$	8 $\mu\text{MAX}$ -8
MAX9933EUA+T	$-40^{\circ}\text{C}$ to $+85^{\circ}\text{C}$	8 $\mu\text{MAX}$ -8

+Denotes a lead-free package.

T = Tape and reel.

## Pin Configurations

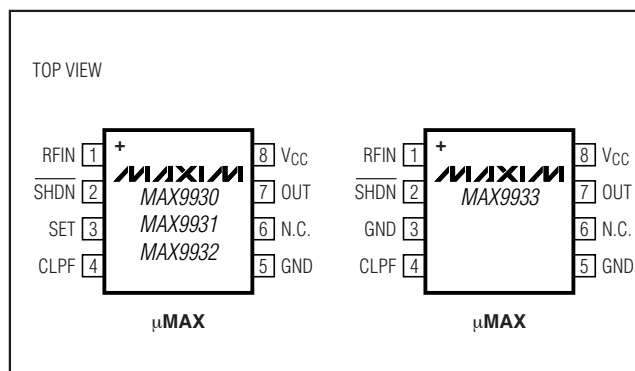

# 2MHz to 1.6GHz 45dB RF-Detecting Controllers and RF Detector

## ABSOLUTE MAXIMUM RATINGS

(Voltages referenced to GND.)

V <sub>CC</sub> .....	-0.3V to +6V
OUT, SET, $\overline{\text{SHDN}}$ , CLPF.....	-0.3V to (V <sub>CC</sub> + 0.3V)
RFIN	
MAX9930/MAX9933 .....	+6dBm
MAX9931 .....	+16dBm
MAX9932 .....	+19dBm
Equivalent Voltage	
MAX9930/MAX9933.....	0.45V <sub>RMS</sub>
MAX9931 .....	1.4V <sub>RMS</sub>
MAX9932 .....	2.0V <sub>RMS</sub>

OUT Short Circuit to GND .....	Continuous
Continuous Power Dissipation (T <sub>A</sub> = +70°C)	
8-Pin $\mu$ MAX (derate 4.5mW/°C above +70°C) .....	362mW
Operating Temperature Range .....	-40°C to +85°C
Storage Temperature Range .....	-65°C to +150°C
Lead Temperature (soldering, 10s) .....	+300°C

Stresses beyond those listed under "Absolute Maximum Ratings" may cause permanent damage to the device. These are stress ratings only, and functional operation of the device at these or any other conditions beyond those indicated in the operational sections of the specifications is not implied. Exposure to absolute maximum rating conditions for extended periods may affect device reliability.

## DC ELECTRICAL CHARACTERISTICS

(V<sub>CC</sub> = 3V,  $\overline{\text{SHDN}}$  = 1.8V, T<sub>A</sub> = -40°C to +85°C, C<sub>CLPF</sub> = 100nF, unless otherwise noted. Typical values are at T<sub>A</sub> = +25°C.) (Note 1)

PARAMETER	SYMBOL	CONDITIONS	MIN	TYP	MAX	UNITS
Supply Voltage	V <sub>CC</sub>		2.70		5.25	V
Supply Current	I <sub>CC</sub>	V <sub>CC</sub> = 5.25V		7	12	mA
Shutdown Supply Current	I <sub>CC</sub>	$\overline{\text{SHDN}}$ = 0.8V, V <sub>CC</sub> = 5V		13		$\mu$ A
Shutdown Output Voltage	V <sub>OUT</sub>	$\overline{\text{SHDN}}$ = 0.8V		1		mV
Logic-High Threshold Voltage	V <sub>H</sub>		1.8			V
Logic-Low Threshold Voltage	V <sub>L</sub>				0.8	V
$\overline{\text{SHDN}}$ Input Current	I $\overline{\text{SHDN}}$	$\overline{\text{SHDN}}$ = 3V		5	30	$\mu$ A
		$\overline{\text{SHDN}}$ = 0V	-1	-0.01		
<b>MAIN OUTPUT (MAX9930/MAX9931/MAX9932)</b>						
Voltage Range	V <sub>OUT</sub>	High, I <sub>SOURCE</sub> = 10mA	2.65	2.75		V
		Low, I <sub>SINK</sub> = 350 $\mu$ A		0.15		
Output-Referred Noise		From CLPF		8		nV/ $\sqrt{\text{Hz}}$
Small-Signal Bandwidth	BW	From CLPF		20		MHz
Slew Rate		V <sub>OUT</sub> = 0.2V to 2.6V from CLPF		8		V/ $\mu$ s
<b>SET INPUT (MAX9930/MAX9931/MAX9932)</b>						
Voltage Range (Note 2)	V <sub>SET</sub>	Corresponding to central 40dB span	0.35		1.45	V
Input Resistance	R <sub>IN</sub>			30		M $\Omega$
Slew Rate (Note 3)				16		V/ $\mu$ s
<b>DETECTOR OUTPUT (MAX9933)</b>						
Voltage Range	V <sub>OUT</sub>	RFIN = 0dBm		1.45		V
		RFIN = -45dBm		0.36		
Small-Signal Bandwidth	BW	C <sub>CLPF</sub> = 150pF		4.5		MHz
Slew Rate		V <sub>OUT</sub> = 0.36V to 1.45V, C <sub>CLPF</sub> = 150pF		5		V/ $\mu$ s

# 2MHz to 1.6GHz 45dB RF-Detecting Controllers and RF Detector

MAX9930-MAX9933

## AC ELECTRICAL CHARACTERISTICS

( $V_{CC} = 3V$ ,  $\overline{SHDN} = 1.8V$ ,  $f_{RF} = 2MHz$  to  $1.6GHz$ ,  $T_A = -40^{\circ}C$  to  $+85^{\circ}C$ ,  $C_{CLPF} = 100nF$ , unless otherwise noted. Typical values are at  $T_A = +25^{\circ}C$ .) (Note 1)

PARAMETER	SYMBOL	CONDITIONS	MIN	TYP	MAX	UNITS	
RF Input Frequency Range	$f_{RF}$		2		1600	MHz	
RF Input Voltage Range (Note 4)	$V_{RF}$	MAX9930/MAX9933	-58		-13	dBV	
		MAX9931	-48		-3		
		MAX9932	-43		+2		
Equivalent Power Range (50 $\Omega$ Termination) (Note 4)	$P_{RF}$	MAX9930/MAX9933	-45		0	dBm	
		MAX9931	-35		+10		
		MAX9932	-30		+15		
Logarithmic Slope	$V_S$	$f_{RF} = 2MHz$ , $T_A = +25^{\circ}C$	25	27	29	mV/dB	
		$f_{RF} = 2MHz$	24	27	30		
		$f_{RF} = 900MHz$ , $T_A = +25^{\circ}C$	23.5	25.5	27.5		
		$f_{RF} = 900MHz$	22.5	25.5	28.5		
		$f_{RF} = 1600MHz$		27			
Logarithmic Intercept	$P_X$	$f_{RF} = 2MHz$ , $T_A = +25^{\circ}C$	MAX9930/MAX9933	-61	-56	-52	dBm
			MAX9931	-51	-46	-42	
			MAX9932	-46	-41	-37	
		$f_{RF} = 2MHz$	MAX9930/MAX9933	-63	-56	-50	
			MAX9931	-53	-46	-40	
			MAX9932	-48	-41	-35	
		$f_{RF} = 900MHz$ , $T_A = +25^{\circ}C$	MAX9930/MAX9933	-62	-59	-53	
			MAX9931	-53	-50	-44	
			MAX9932	-49	-45	-40	
		$f_{RF} = 900MHz$	MAX9930/MAX9933	-64	-59	-51	
			MAX9931	-55	-50	-42	
			MAX9932	-51	-45	-38	
		$f_{RF} = 1600MHz$	MAX9930/MAX9933		-62		
			MAX9931		-52		
			MAX9932		-47		
<b>RF INPUT INTERFACE</b>							
DC Resistance	$R_{DC}$	Connected to $V_{CC}$		2		k $\Omega$	
Inband Capacitance	$C_{IB}$	Internally DC-coupled (Note 5)		0.5		pF	

**Note 1:** All devices are 100% production tested at  $T_A = +25^{\circ}C$  and are guaranteed by design for  $T_A = -40^{\circ}C$  to  $+85^{\circ}C$  as specified.

**Note 2:** Typical value only, set-point input voltage range determined by logarithmic slope and logarithmic intercept.

**Note 3:** Set-point slew rate is the rate at which the reference level voltage, applied to the inverting input of the  $g_m$  stage, responds to a voltage step at the SET pin (see Figure 1).

**Note 4:** Typical min/max range for detector.

**Note 5:** Pin capacitance to ground.

# 2MHz to 1.6GHz 45dB RF-Detecting Controllers and RF Detector

## Typical Operating Characteristics

( $V_{CC} = 3V$ ,  $\overline{SHDN} = V_{CC}$ ,  $T_A = +25^\circ C$ , all log conformance plots are normalized to their respective temperatures,  $T_A = +25^\circ C$ , unless otherwise noted.)

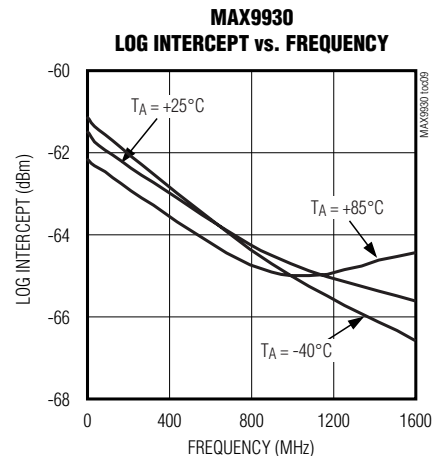
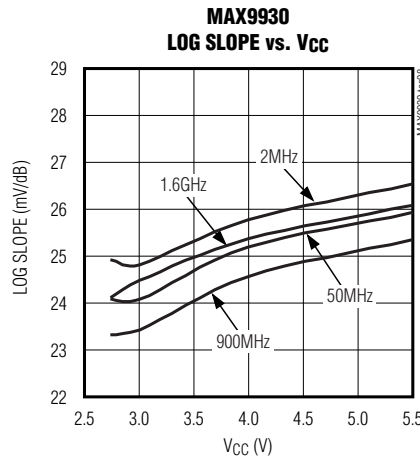
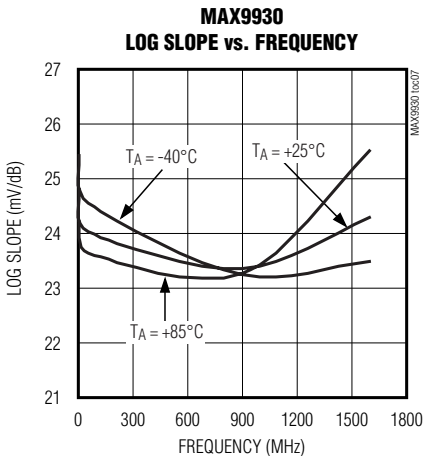
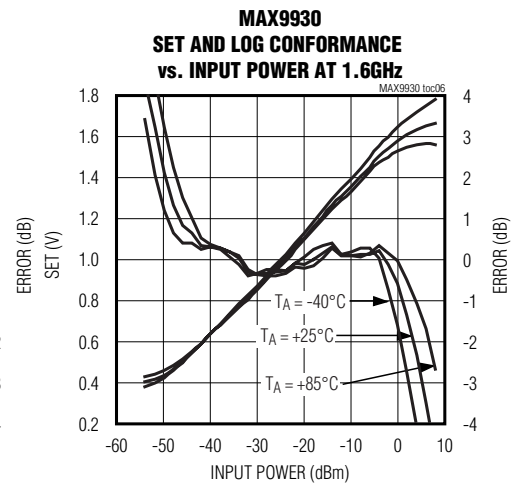
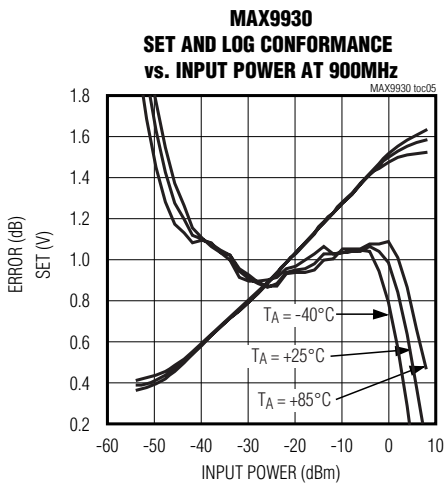
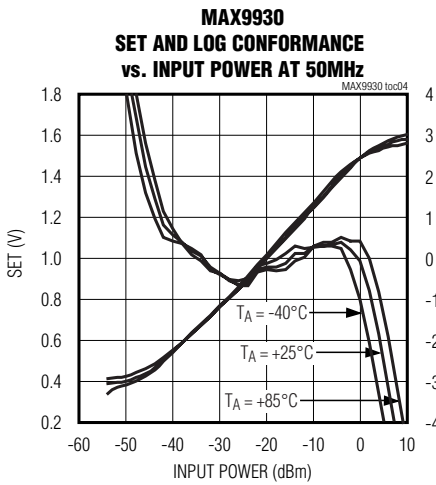
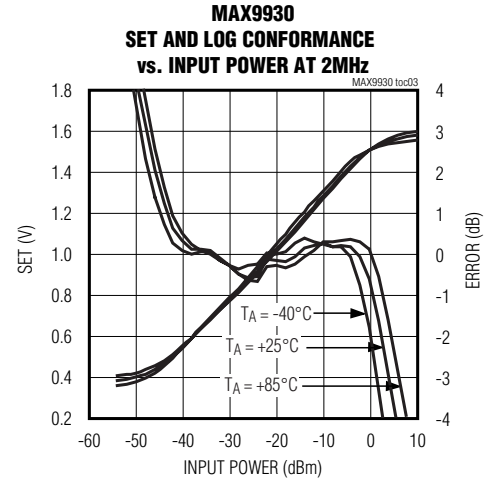
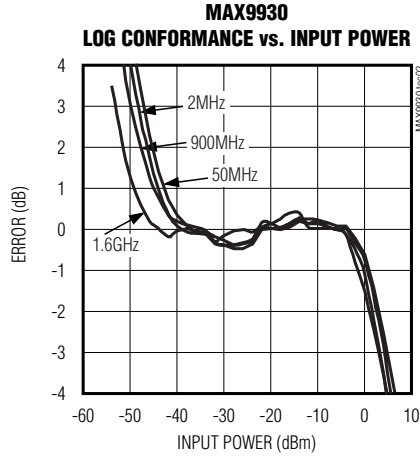
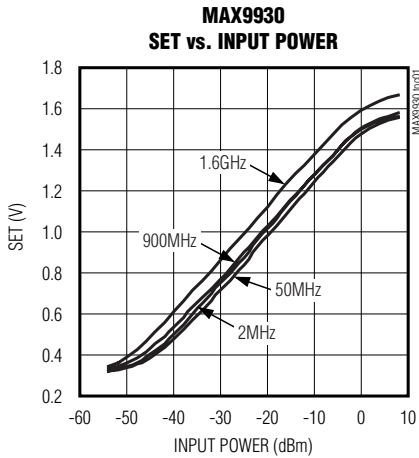

# 2MHz to 1.6GHz 45dB RF-Detecting Controllers and RF Detector

## Typical Operating Characteristics (continued)

( $V_{CC} = 3V$ ,  $\overline{SHDN} = V_{CC}$ ,  $T_A = +25^\circ C$ , all log conformance plots are normalized to their respective temperatures,  $T_A = +25^\circ C$ , unless otherwise noted.)

MAX9930-MAX9933

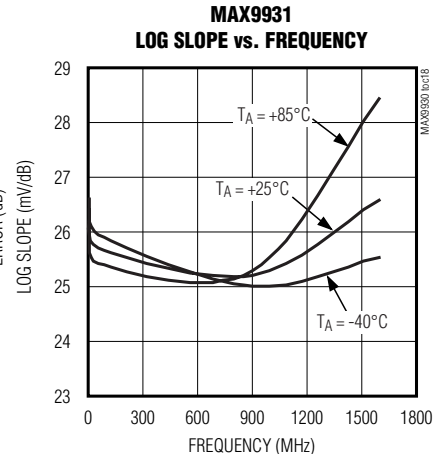
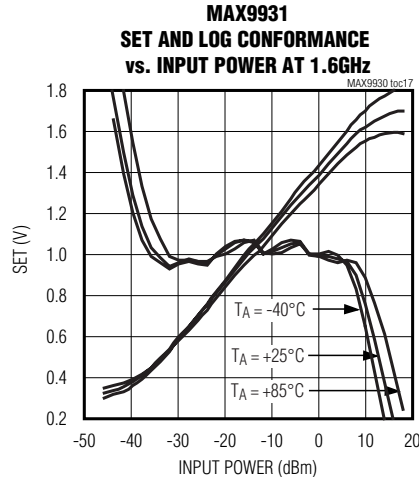
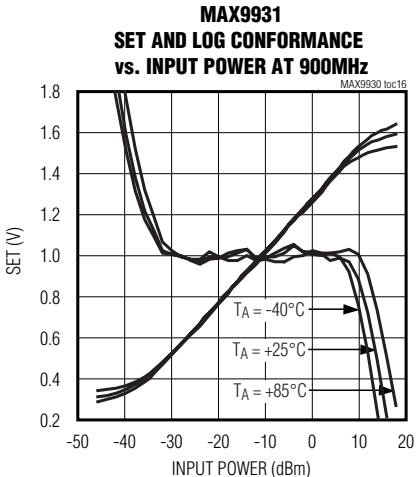
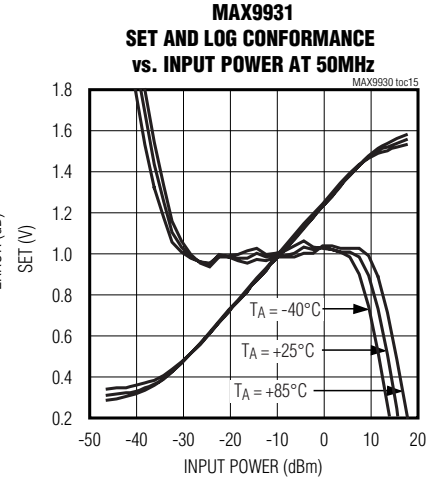
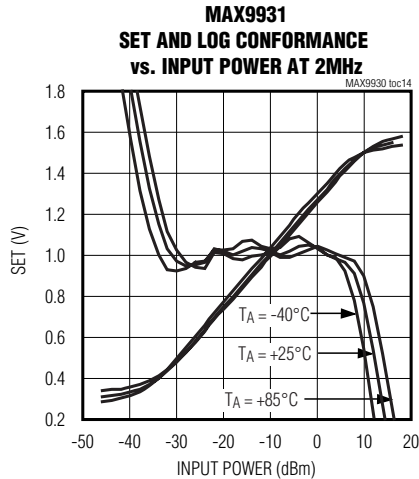
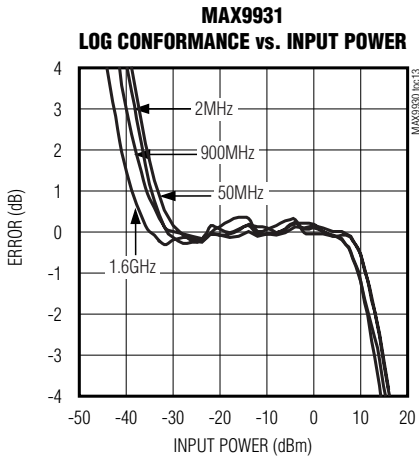
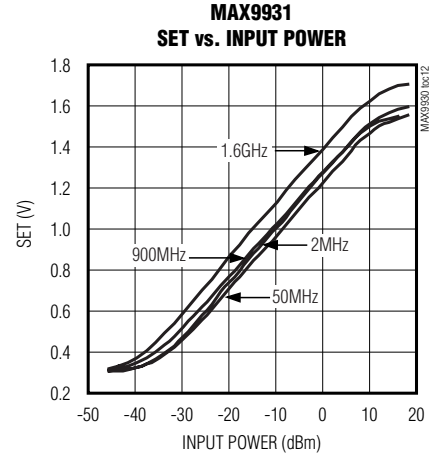
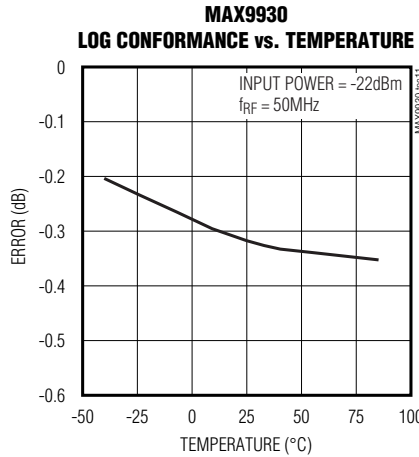
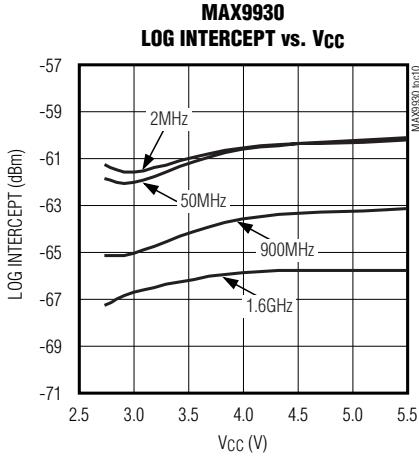

# 2MHz to 1.6GHz 45dB RF-Detecting Controllers and RF Detector

## Typical Operating Characteristics (continued)

( $V_{CC} = 3V$ ,  $\overline{SHDN} = V_{CC}$ ,  $T_A = +25^\circ C$ , all log conformance plots are normalized to their respective temperatures,  $T_A = +25^\circ C$ , unless otherwise noted.)

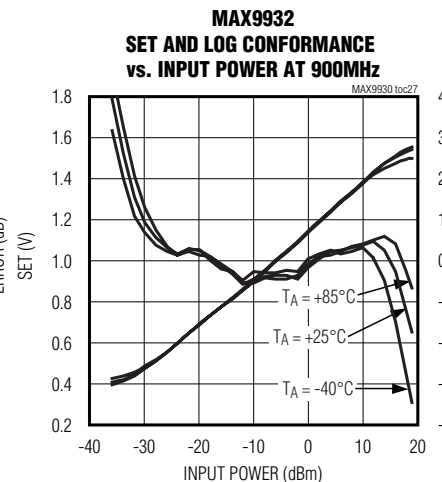
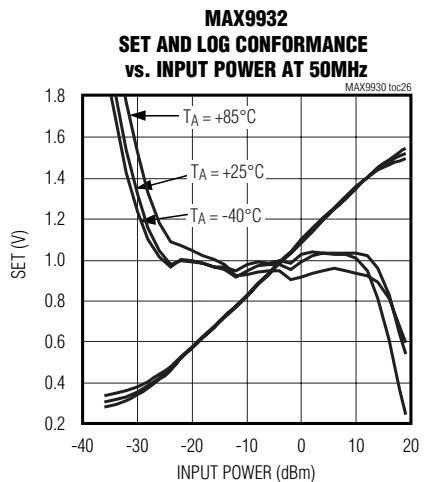
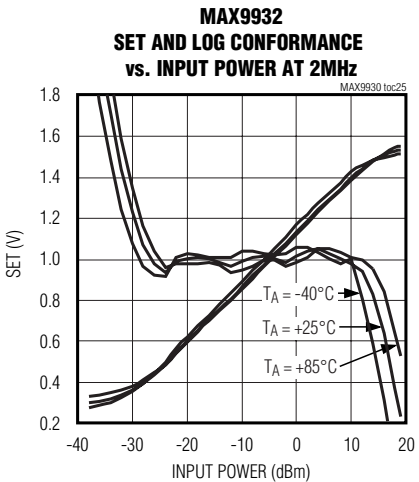
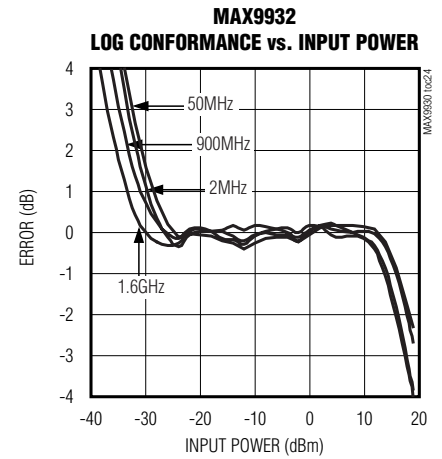
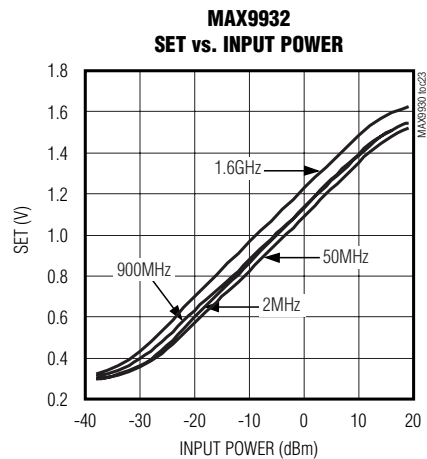
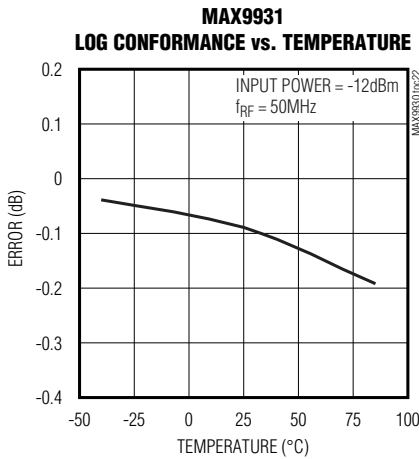
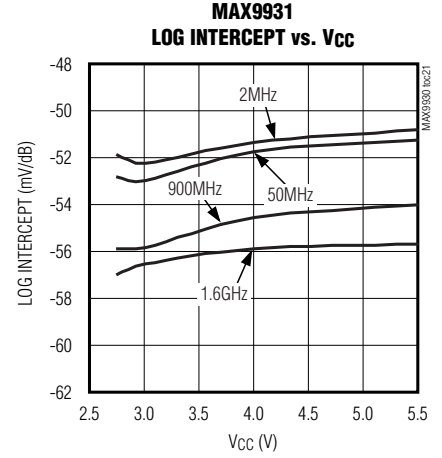
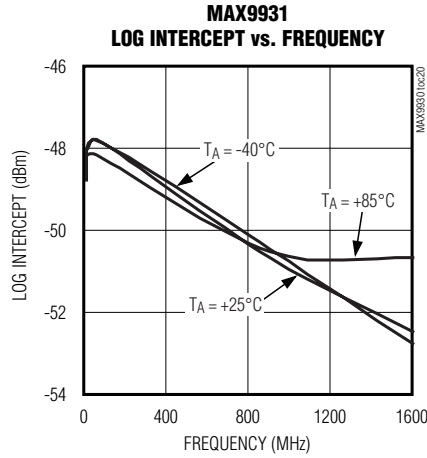
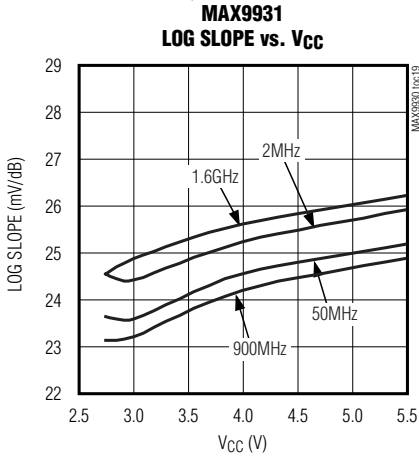

# 2MHz to 1.6GHz 45dB RF-Detecting Controllers and RF Detector

MAX9930-MAX9933

## Typical Operating Characteristics (continued)

( $V_{CC} = 3V$ ,  $\overline{SHDN} = V_{CC}$ ,  $T_A = +25^\circ C$ , all log conformance plots are normalized to their respective temperatures,  $T_A = +25^\circ C$ , unless otherwise noted.)

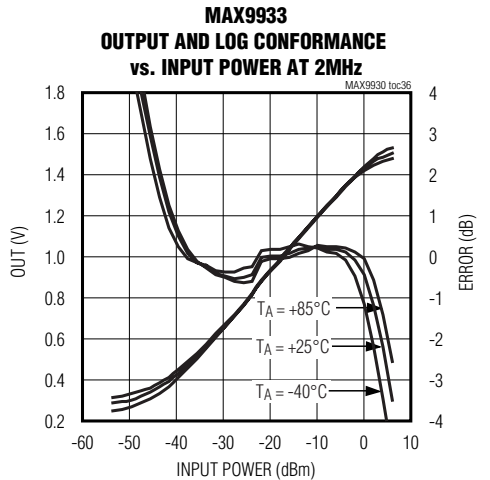
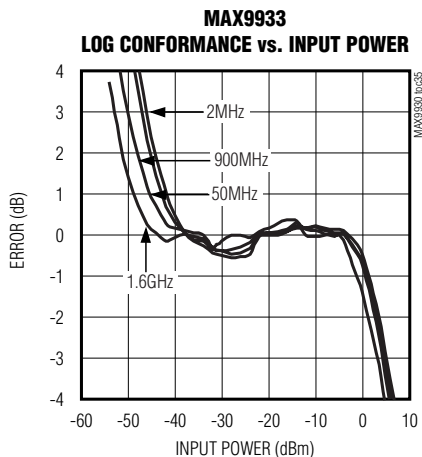
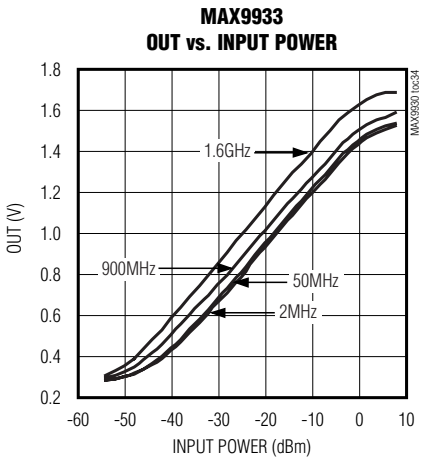
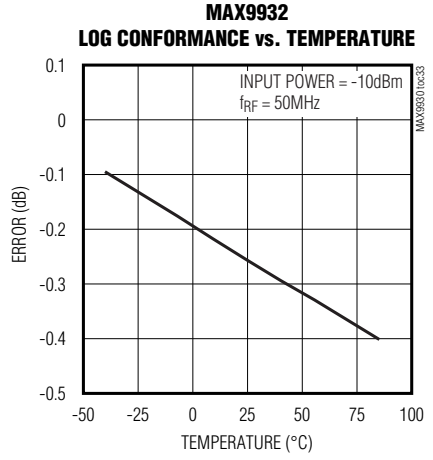
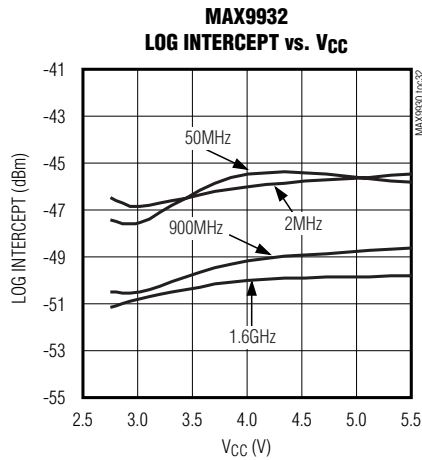
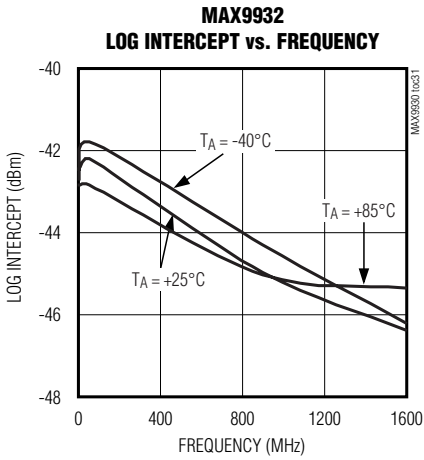
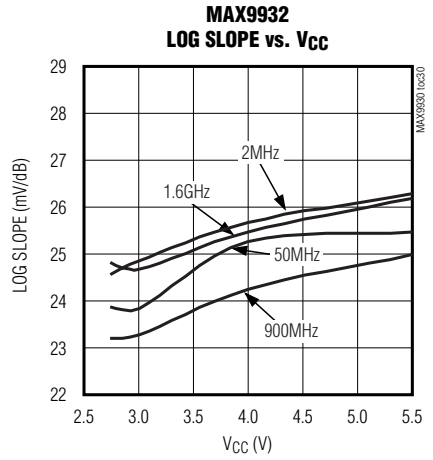
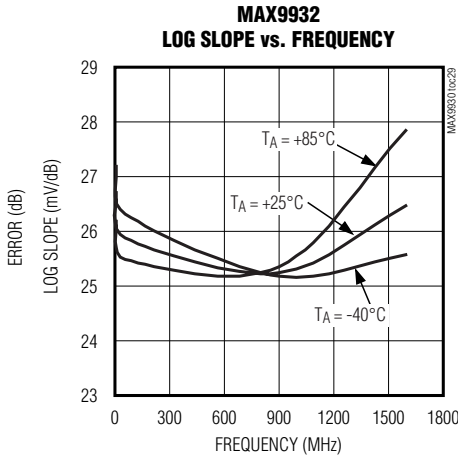
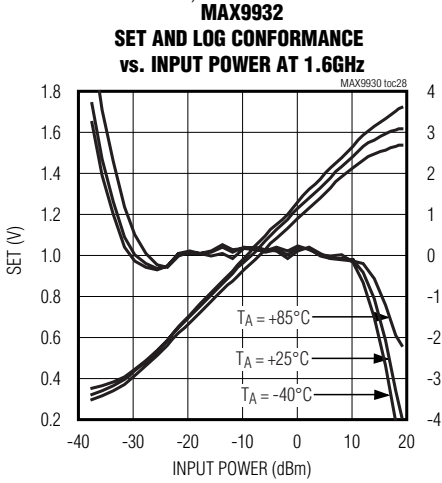

# 2MHz to 1.6GHz 45dB RF-Detecting Controllers and RF Detector

## Typical Operating Characteristics (continued)

( $V_{CC} = 3V$ ,  $\overline{SHDN} = V_{CC}$ ,  $T_A = +25^\circ C$ , all log conformance plots are normalized to their respective temperatures,  $T_A = +25^\circ C$ , unless otherwise noted.)

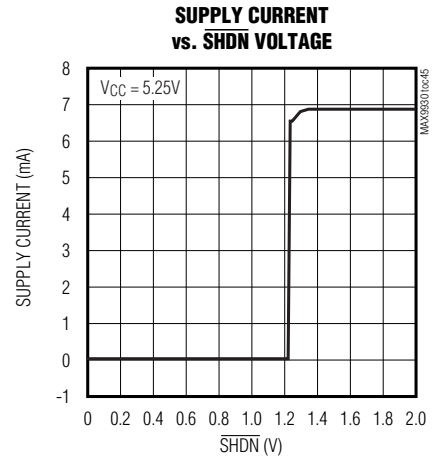
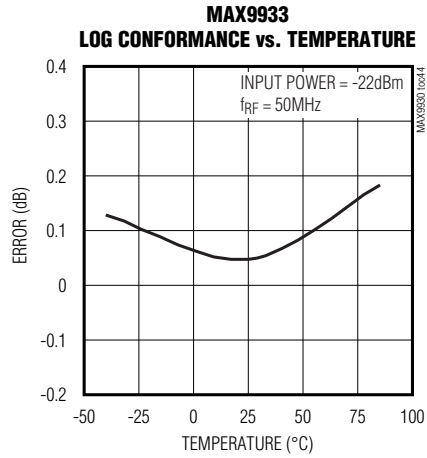
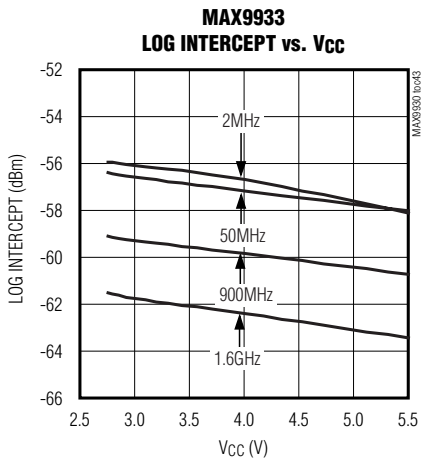
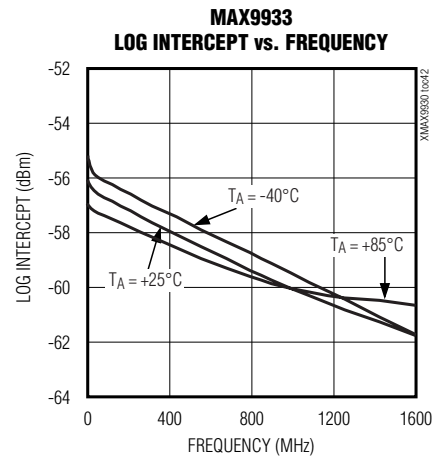
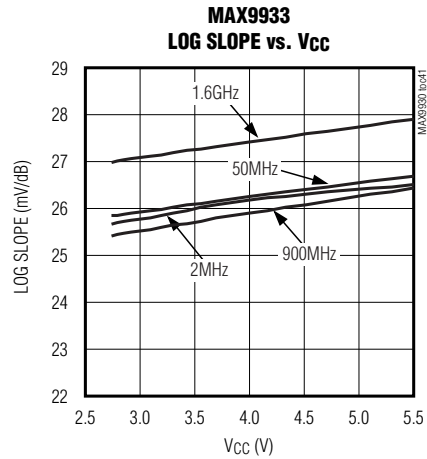
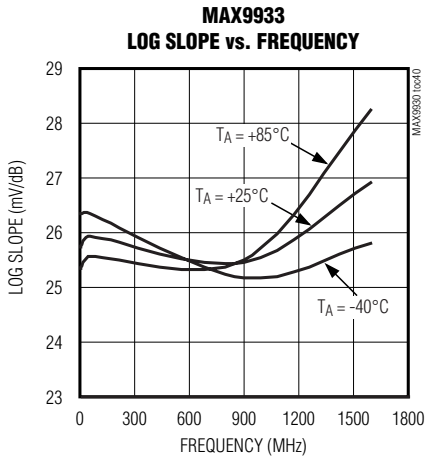
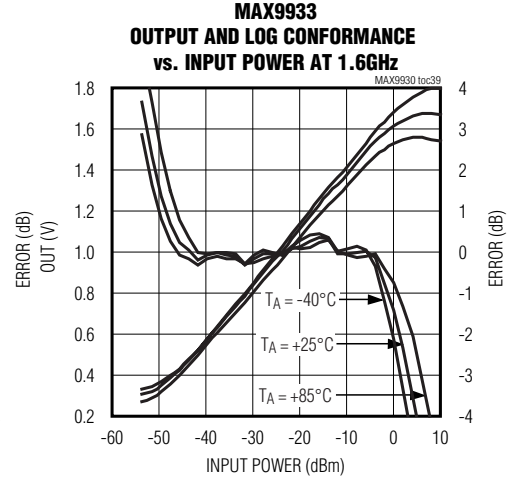
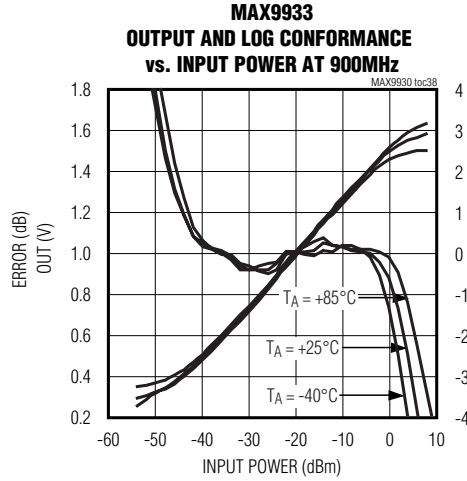
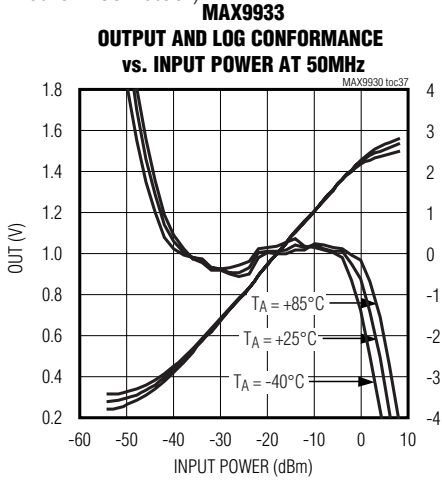



# 2MHz to 1.6GHz 45dB RF-Detecting Controllers and RF Detector

MAX9930-MAX9933

## Typical Operating Characteristics (continued)

( $V_{CC} = 3V$ ,  $\overline{SHDN} = V_{CC}$ ,  $T_A = +25^\circ C$ , all log conformance plots are normalized to their respective temperatures,  $T_A = +25^\circ C$ , unless otherwise noted.)

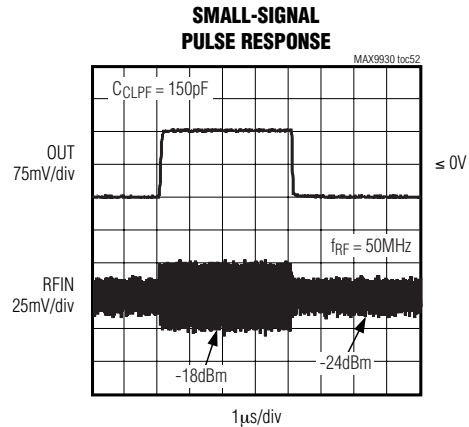
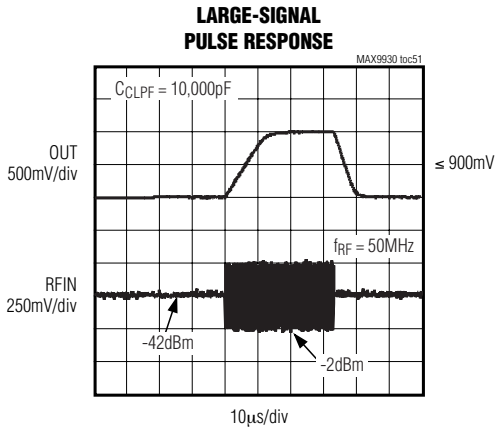
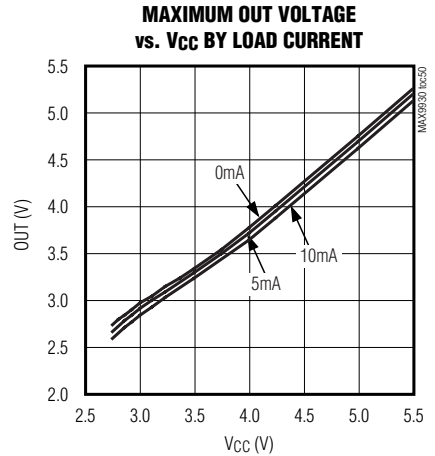
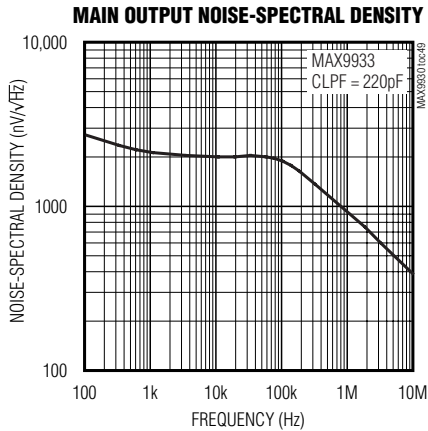
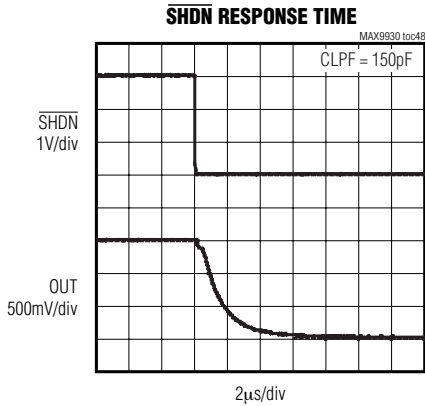
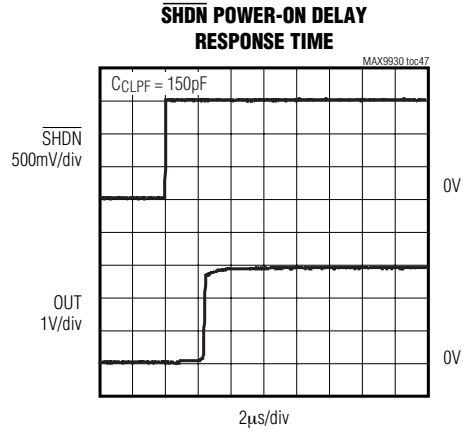
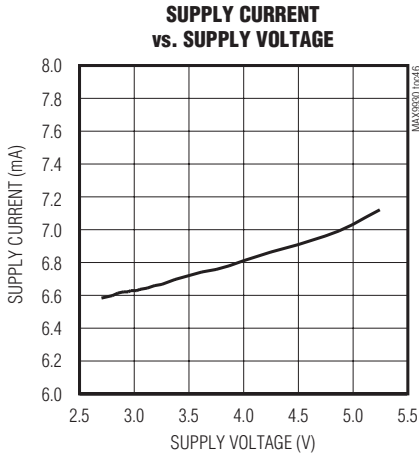

# 2MHz to 1.6GHz 45dB RF-Detecting Controllers and RF Detector

## Pin Description

PIN		NAME	FUNCTION
MAX9930/ MAX9931/ MAX9932	MAX9933		
1	1	RFIN	RF Input
2	2	$\overline{\text{SHDN}}$	Shutdown. Connect to $V_{CC}$ for normal operation.
3	—	SET	Set-Point Input
4	4	CLPF	Lowpass Filter Connection. Connect external capacitor between CLPF and GND to set control-loop bandwidth.
5	3, 5	GND	Ground
6	6	N.C.	No Connection. Not internally connected.
7	7	OUT	PA Gain-Control Output
8	8	$V_{CC}$	Supply Voltage. Bypass to GND with a 0.1 $\mu\text{F}$ capacitor.

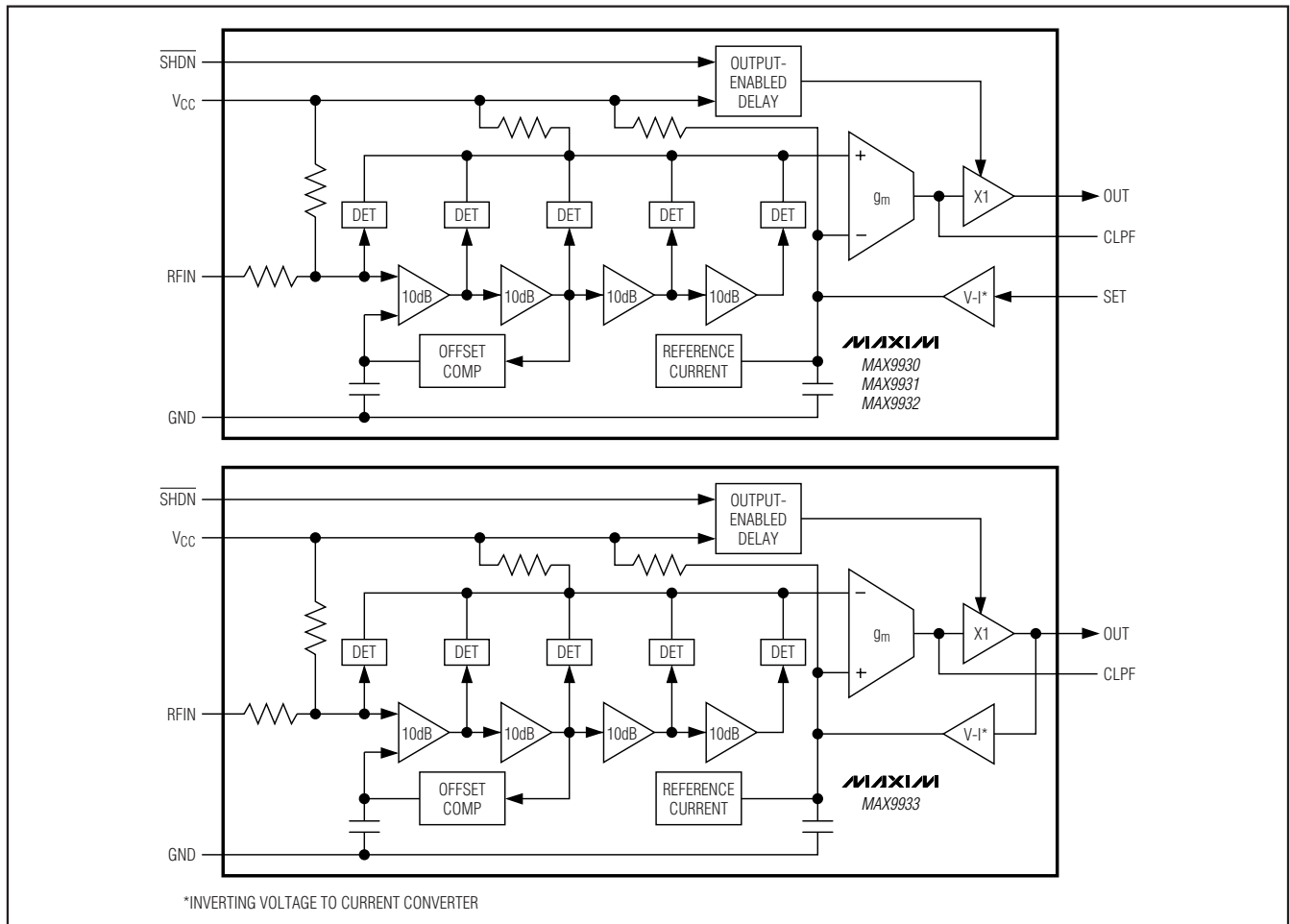

Figure 1. Functional Diagram

# 2MHz to 1.6GHz 45dB RF-Detecting Controllers and RF Detector

## Detailed Description

The MAX9930–MAX9933 family of logarithmic amplifiers (log amps) comprises four main amplifier/limiter stages each with a small-signal gain of 10dB. The output stage of each amplifier is applied to a full-wave rectifier (detector). A detector stage also precedes the first gain stage. In total, five detectors, each separated by 10dB, comprise the log amp strip. Figure 1 shows the functional diagram of the log amps.

A portion of the PA output power is coupled to RFIN of the logarithmic amplifier controller/detector, and is applied to the logarithmic amplifier strip. Each detector cell outputs a rectified current and all cell currents are summed and form a logarithmic output. The detected output is applied to a high-gain  $g_m$  stage, which is buffered and then applied to OUT. For the MAX9930/MAX9931/MAX9932, OUT is applied to the gain-control input of the PA to close the control loop. The voltage applied to SET determines the output power of the PA in the control loop. The voltage applied to SET relates to an input power level determined by the log amp detector characteristics. For the MAX9933, OUT is applied to an ADC typically found in a baseband IC which, in turn, controls the PA biasing with the output (Figure 2).

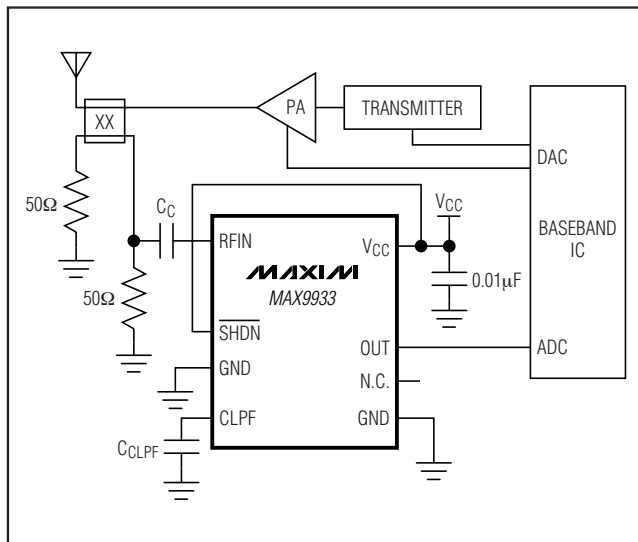

Figure 2. MAX9933 Typical Application Circuit

Extrapolating a straight-line fit of the graph of SET vs. RFIN provides the logarithmic intercept. Logarithmic slope, the amount SET changes for each dB change of RF input, is generally independent of waveform or termination impedance. The MAX9930/MAX9931/MAX9932 slope at low frequencies is about 25mV/dB.

Variance in temperature and supply voltage does not alter the slope significantly as shown in the *Typical Operating Characteristics*.

The MAX9930/MAX9931/MAX9932 are specifically designed for use in PA control applications. In a control loop, the output starts at approximately 2.9V (with supply voltage of 3V) for the minimum input signal and falls to a value close to ground at the maximum input. With a portion of the PA output power coupled to RFIN, apply a voltage to SET (for the MAX9930/MAX9931/MAX9932) and connect OUT to the gain-control pin of the PA to control its output power. An external capacitor from CLPF to ground sets the bandwidth of the PA control loop.

## Transfer Function

Logarithmic slope and intercept determine the transfer function of the MAX9930–MAX9933 family of log amps. The change in SET voltage (OUT voltage for the MAX9933) per dB change in RF input defines the logarithmic slope. Therefore, a 10dB change in RF input results in a 250mV change at SET (OUT for the MAX9933). The Log Conformance vs. Input Power plots (see *Typical Operating Characteristics*) show the dynamic range of the log amp family. Dynamic range is the range for which the error remains within a band of  $\pm 1$ dB.

The intercept is defined as the point where the linear response, when extrapolated, intersects the y-axis of the Log Conformance vs. Input Power plot. Using these parameters, the input power can be calculated at any SET voltage level (OUT voltage level for the MAX9933) within the specified input range with the following equations:

$$RFIN = (SET / SLOPE) + IP$$

(MAX9930/MAX9931/MAX9932)

$$RFIN = (OUT / SLOPE) + IP$$

(MAX9933)

where SET is the set-point voltage, OUT is the output voltage for the MAX9933, SLOPE is the logarithmic slope (V/dB), RFIN is in either dBm or dBV and IP is the logarithmic intercept point utilizing the same units as RFIN.

# 2MHz to 1.6GHz 45dB RF-Detecting Controllers and RF Detector

## Applications Information

### Controller Mode (MAX9930/MAX9931/MAX9932)

Figure 3 provides a circuit example of the MAX9930/MAX9931/MAX9932 configured as a controller. The MAX9930/MAX9931/MAX9932 require a 2.7V to 5.25V supply voltage. Place a 0.1µF low-ESR, surface-mount ceramic capacitor close to V<sub>CC</sub> to decouple the supply. Electrically isolate the RF input from other pins (especially SET) to maximize performance at high frequencies (especially at the high-power levels of the MAX9932). The MAX9930/MAX9931/MAX9932 require external AC-coupling. Achieve 50Ω input matching by connecting a 50Ω resistor between the AC-coupling capacitor of RFIN and ground.

The MAX9930/MAX9931/MAX9932 logarithmic amplifiers function as both the detector and controller in power-control loops. Use a directional coupler to couple a portion of the PA's output power to the log amp's RF input. For applications requiring dual-mode operation and where there are two PAs and two directional couplers, passively combine the outputs of the directional couplers before applying to the log amp. Apply a set-point voltage to SET from a controlling source (usually a DAC). OUT, which drives the automatic gain-control input of the PA, corrects any inequality between the RF input level and the corresponding set-point level. This is valid assuming the gain control of the variable gain element is positive, such that increasing OUT voltage

increases gain. The OUT voltage can range from 150mV to within 250mV of the positive supply rail while sourcing 10mA. Use a suitable load resistor between OUT and GND for PA control inputs that source current. The *Typical Operating Characteristics* has the Maximum Out Voltage vs. V<sub>CC</sub> By Load Current graph that shows the sourcing capabilities and output swing of OUT.

### SHDN and Power-On

The MAX9930-MAX9933 can be placed in shutdown by pulling SHDN to ground. Shutdown reduces supply current to typically 13µA. A graph of SHDN Response Time is included in the *Typical Operating Characteristics*. Connect SHDN and V<sub>CC</sub> together for continuous on operation.

### Power Convention

Expressing power in dBm, decibels above 1mW, is the most common convention in RF systems. Log amp input levels specified in terms of power are a result of the following common convention. Note that input power does not refer to power, but rather to input voltage relative to a 50Ω impedance. Use of dBV, decibels with respect to a 1V<sub>RMS</sub> sine wave, yields a less ambiguous result. The dBV convention has its own pitfalls in that log amp response is also dependent on waveform. A complex input, such as CDMA, does not have the exact same output response as the sinusoidal signal. The MAX9930-MAX9933 performance specifications are in both dBV and dBm, with equivalent dBm levels for a 50Ω environment. To convert dBV values into dBm in a 50Ω network, add 13dB. For CATV applications, to convert dBV values to dBm in a 75Ω network, add 11.25dB. Table 1 shows the different input power ranges in different conventions for the MAX9930-MAX9933.

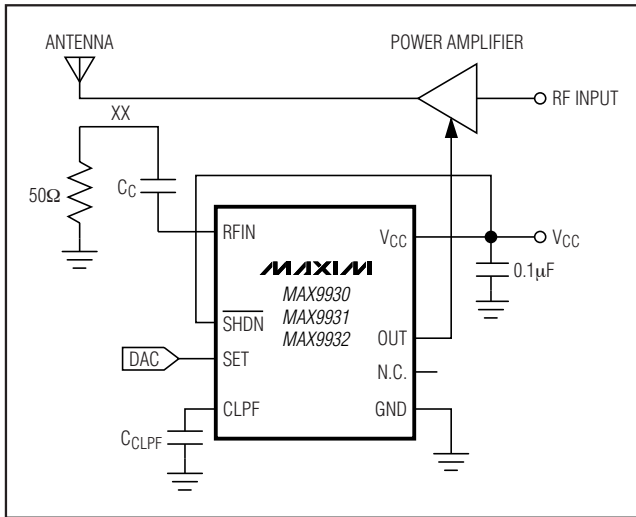

Figure 3. Control Mode Application Circuit Block

Table 1. Power Ranges of the MAX9930-MAX9933

PART	INPUT POWER RANGE		
	dBV	dBm IN A 50Ω NETWORK	dBm IN A 75Ω NETWORK
MAX9930	-58 to -13	-45 to 0	-46.75 to -1.75
MAX9931	-48 to -3	-35 to +10	-36.75 to +8.25
MAX9932	-43 to +2	-30 to +15	-31.75 to +13.25
MAX9933	-58 to -13	-45 to 0	-46.75 to -1.75

# 2MHz to 1.6GHz 45dB RF-Detecting Controllers and RF Detector

## Filter Capacitor and Transient Response

In general, for the MAX9930/MAX9931/MAX9932, the choice of filter capacitor only partially determines the time-domain response of a PA control loop. However, some simple conventions can be applied to affect transient response. A large filter capacitor,  $C_{CLPF}$ , dominates time-domain response, but the loop bandwidth remains a factor of the PA gain-control range. The bandwidth is maximized at power outputs near the center of the PA's range, and minimized at the low and high power levels, where the slope of the gain-control curve is lowest.

A smaller valued  $C_{CLPF}$  results in an increased loop bandwidth inversely proportional to the capacitor value. Inherent phase lag in the PA's control path, usually caused by parasitics at OUT, ultimately results in the addition of complex poles in the AC loop equation. To avoid this secondary effect, experimentally determine the lowest usable  $C_{CLPF}$  for the power amplifier of interest. This requires full consideration to the intricacies of the PA control function. The worst-case condition, where the PA output is smallest (gain function is steepest) should be used because the PA control function is typically nonlinear. An additional zero can be added to improve loop dynamics by placing a resistor in series with  $C_{CLPF}$ . See Figure 4 for the gain and phase response for different  $C_{CLPF}$  values.

## Additional Input Coupling

There are three common methods for input coupling: broadband resistive, narrowband reactive, and series

attenuation. A broadband resistive match is implemented by connecting a resistor to ground at the external AC-coupling capacitor at RFIN as shown in Figure 5. A  $50\Omega$  resistor (use other values for different input impedances) in this configuration, in parallel with the input impedance of the MAX9930-MAX9933, presents an input impedance of approximately  $50\Omega$ . These devices require an additional external coupling capacitor in series with the RF input. As the operating frequency increases over 2GHz, input impedance is reduced, resulting in the need for a larger-valued shunt resistor. Use a Smith Chart for calculating the ideal shunt resistor value. Refer to the MAX4000/MAX4001/MAX4002 data sheet for narrowband reactive and series attenuation input coupling.

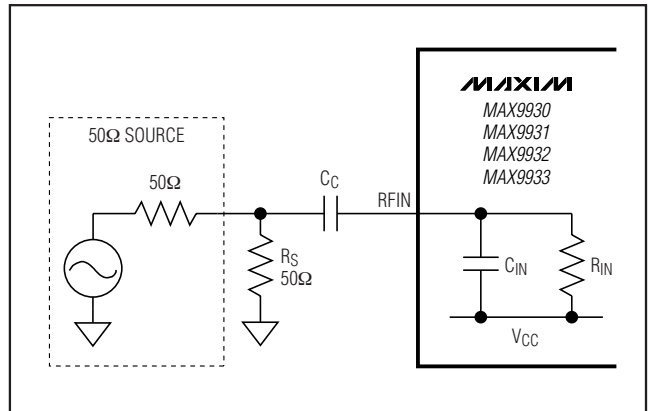

Figure 5. Broadband Resistive Matching

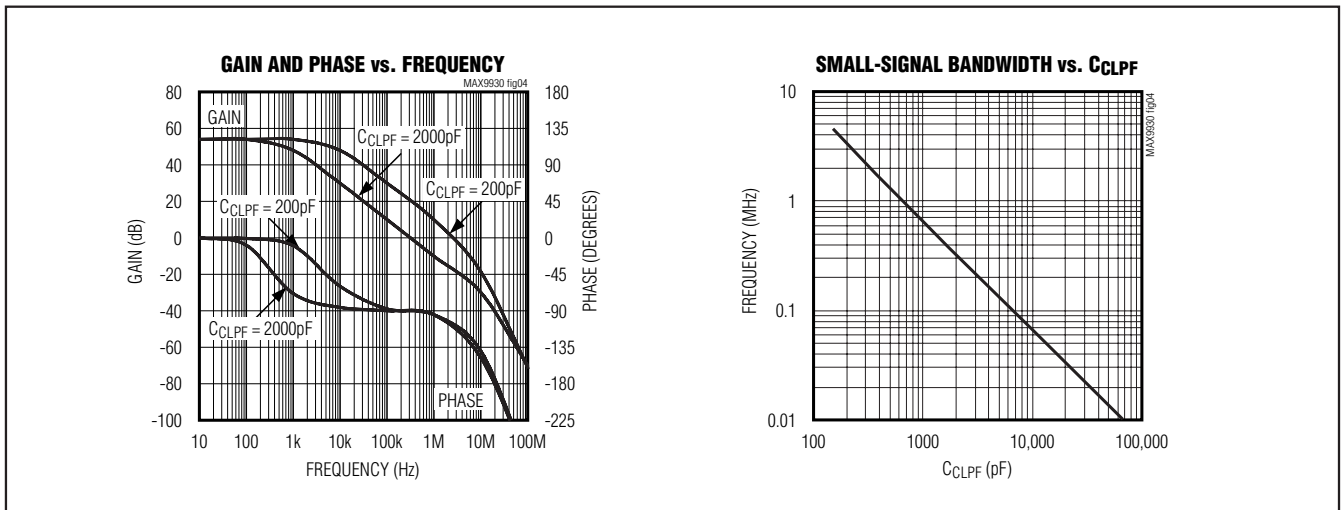

Figure 4. Gain and Phase vs. Frequency

# 2MHz to 1.6GHz 45dB RF-Detecting Controllers and RF Detector

## Waveform Considerations

The MAX9930-MAX9933 family of logarithmic amplifiers respond to voltage, not power, even though input levels are specified in dBm. It is important to realize that input signals with identical RMS power but unique waveforms result in different log amp outputs. Differing signal waveforms result in either an upward or downward shift in the logarithmic intercept. However, the logarithmic slope remains the same; it is possible to compensate for known waveform shapes by baseband process.

It must also be noted that the output waveform is generated by first rectifying and then averaging the input signal. This method should not be confused with RMS or peak-detection methods.

## Layout Considerations

As with any RF circuit, the layout of the MAX9930-MAX9933 circuits affects performance. Use a short 50Ω line at the input with multiple ground vias along the length of the line. The input capacitor and resistor should both be placed as close as possible to the IC. V<sub>CC</sub> should be bypassed as close as possible to the IC with multiple vias connecting the capacitor to the ground plane. It is recommended that good RF components be chosen for the desired operating frequency range. **Electrically isolate RF input from other pins (especially SET) to maximize performance at high frequencies (especially at the high power levels of the MAX9932).**

## Chip Information

PROCESS: High-Frequency Bipolar

## Block Diagram

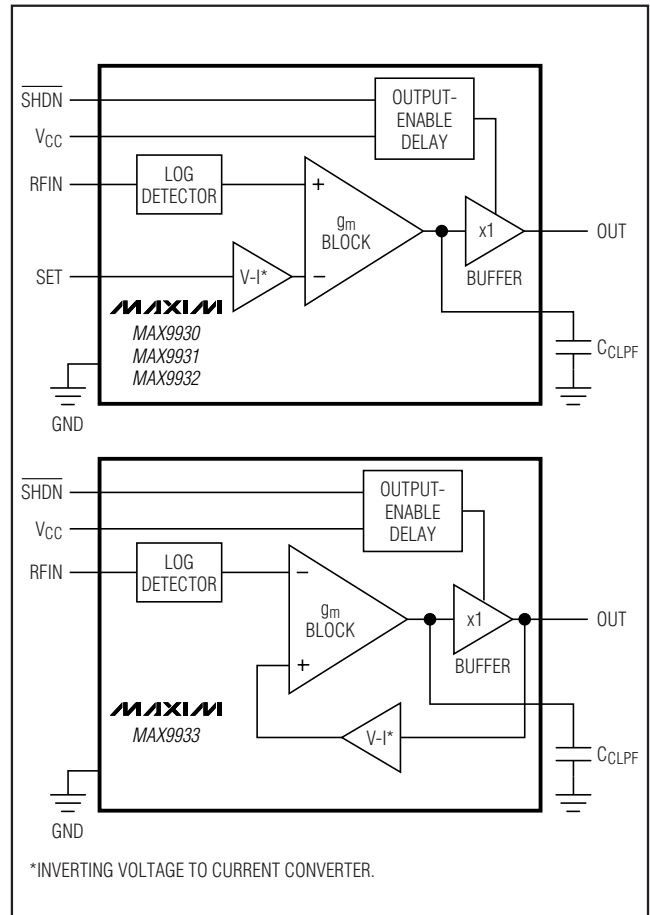

# 2MHz to 1.6GHz 45dB RF-Detecting Controllers and RF Detector

## Package Information

For the latest package outline information and land patterns, go to [www.maxim-ic.com/packages](http://www.maxim-ic.com/packages).

PACKAGE TYPE	PACKAGE CODE	DOCUMENT NO.
8 $\mu$ MAX	U8-1	<a href="#">21-0140</a>

MAX9930-MAX9933

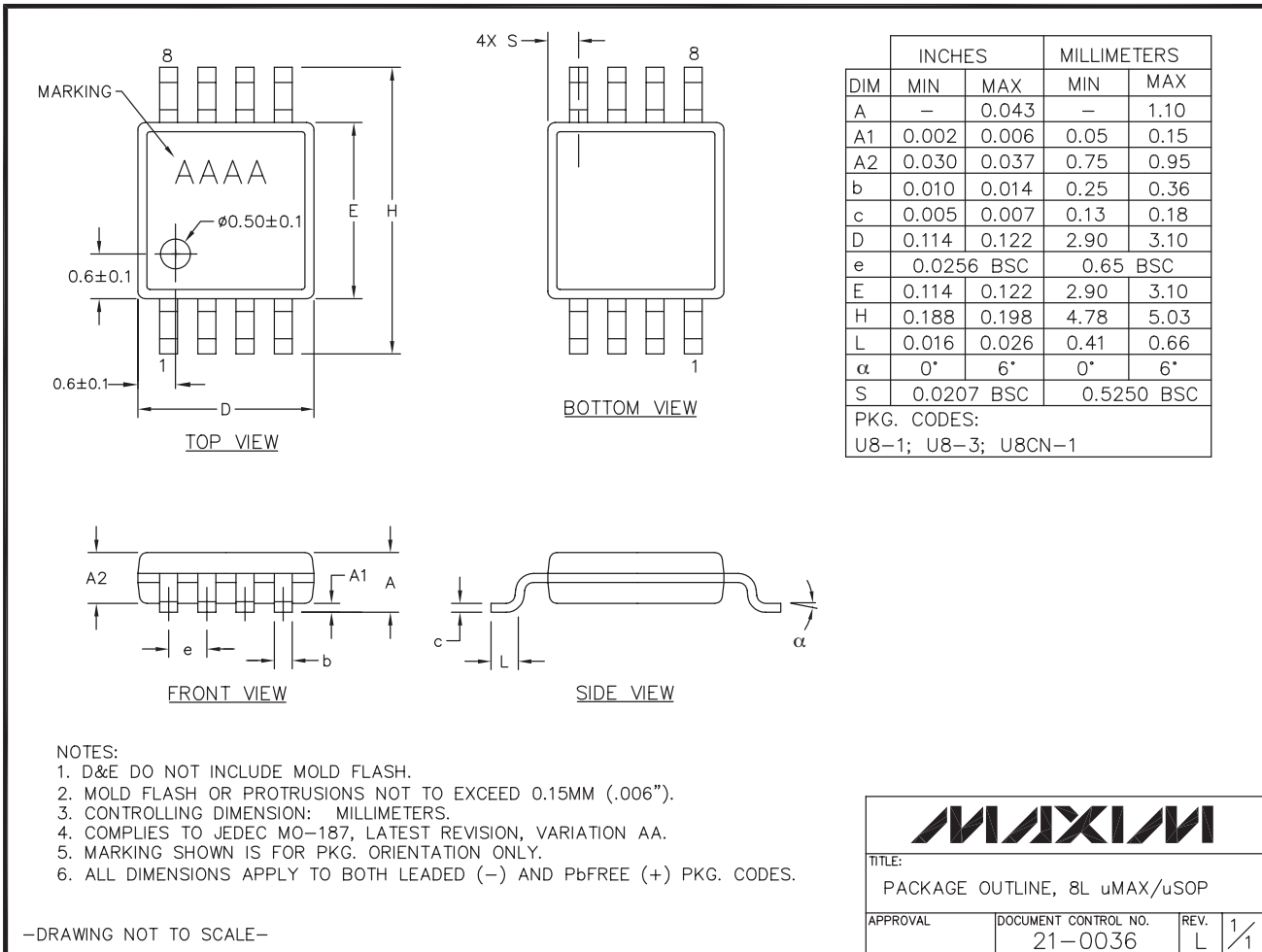

# 2MHz to 1.6GHz 45dB RF-Detecting Controllers and RF Detector

## Revision History

REVISION NUMBER	REVISION DATE	DESCRIPTION	PAGES CHANGED
0	8/07	Initial release	—
1	3/09	Added TOC46 to <i>Typical Operating Characteristics</i>	9

Maxim cannot assume responsibility for use of any circuitry other than circuitry entirely embodied in a Maxim product. No circuit patent licenses are implied. Maxim reserves the right to change the circuitry and specifications without notice at any time.

16 **Maxim Integrated Products, 120 San Gabriel Drive, Sunnyvale, CA 94086 408-737-7600**