



Balun Transformers

Wound SMD

ATB series

ATB3225-75011CT (3.2×2.5×2.3mm)

ATB3225-75032CT (3.2×2.5×2.3mm)

ATB3225-75034CT (3.2×2.5×2.3mm)

ATB3225-50011CT (3.2×2.5×2.3mm)

REMINDERS FOR USING THESE PRODUCTS

Before using these products, be sure to request the delivery specifications.

SAFETY REMINDERS

Please pay sufficient attention to the warnings for safe designing when using these products.

REMINDERS

- The storage period is less than 6 months. Be sure to follow the storage conditions (Temperature: 5 to 40°C, Humidity: 10 to 75% RH or less).
If the storage period elapses, the soldering of the terminal electrodes may deteriorate.
- Do not use or store in locations where there are conditions such as gas corrosion (salt, acid, alkali, etc.).
- Before soldering, be sure to preheat components.
The preheating temperature should be set so that the temperature difference between the solder temperature and chip temperature does not exceed 150°C.
- Soldering corrections after mounting should be within the range of the conditions determined in the specifications.
If overheated, a short circuit, performance deterioration, or lifespan shortening may occur.
- When embedding a printed circuit board where a chip is mounted to a set, be sure that residual stress is not given to the chip due to the overall distortion of the printed circuit board and partial distortion such as at screw tightening portions.
- Self heating (temperature increase) occurs when the power is turned ON, so the tolerance should be sufficient for the set thermal design.
- Carefully lay out the coil for the circuit board design of the non-magnetic shield type.
A malfunction may occur due to magnetic interference.
- Use a wrist band to discharge static electricity in your body through the grounding wire.
- Do not expose the products to magnets or magnetic fields.
- Do not use for a purpose outside of the contents regulated in the delivery specifications.
- The products listed on this catalog are intended for use in general electronic equipment (AV equipment, telecommunications equipment, home appliances, amusement equipment, computer equipment, personal equipment, office equipment, measurement equipment, industrial robots) under a normal operation and use condition.
The products are not designed or warranted to meet the requirements of the applications listed below, whose performance and/or quality require a more stringent level of safety or reliability, or whose failure, malfunction or trouble could cause serious damage to society, person or property.
If you intend to use the products in the applications listed below or if you have special requirements exceeding the range or conditions set forth in the each catalog, please contact us.

- (1) Aerospace/Aviation equipment
- (2) Transportation equipment (cars, electric trains, ships, etc.)
- (3) Medical equipment
- (4) Power-generation control equipment
- (5) Atomic energy-related equipment
- (6) Seabed equipment
- (7) Transportation control equipment

- (8) Public information-processing equipment
- (9) Military equipment
- (10) Electric heating apparatus, burning equipment
- (11) Disaster prevention/crime prevention equipment
- (12) Safety equipment
- (13) Other applications that are not considered general-purpose applications

When designing your equipment even for general-purpose applications, you are kindly requested to take into consideration securing protection circuit/device or providing backup circuits in your equipment.

Balun Transformers

Wound SMD

Halogen-free
Compatible with lead-free solders

Overview of the ATB Series

FEATURES

- The ATB3225 case size is L3.2×W2.5×H2.3mm.
- The case size is smaller than conventional baluns.
- The frequency band width for ATB3225-75011CT is 5 to 200MHz, for ATB3225-75032CT is 5 to 100MHz, for ATB3225-75034CT is 1 to 100MHz and for ATB3225-50011CT is 1 to 100MHz.
- Low insertion loss and good balance parameters.
- Conforms to the RoHS Directive.

APPLICATION

Cable modem

PART NUMBER CONSTRUCTION

ATB		3225		-	750		11		CT		-	T		000	
Series name		LxWxH Dimensions (mm)		Impedance (Ω) at 100MHz		Impedance ratio		Type		Packaging style		Internal code			
		3.2x2.5x2.3		750 75 500 50		11 1:1 32 3:2 34 3:4		CT Center tap		T ø180mm reel					

OPERATING TEMPERATURE RANGE, PACKAGE QUANTITY, PRODUCT WEIGHT

Type	Temperature range		Reel diameter	Package quantity (pieces/reel)	Individual weight (mg)
	Operating temperature*	Storage temperature**			
	(°C)	(°C)			
ATB3225-75011CT	-25 to +85	-25 to +85	ø180mm	1000	75
ATB3225-75032CT	-25 to +85	-25 to +85	ø180mm	1000	75
ATB3225-75034CT	-25 to +85	-25 to +85	ø180mm	1000	75
ATB3225-50011CT	-25 to +85	-25 to +85	ø180mm	1000	75

* Operating temperature range includes self-temperature rise.

** The Storage temperature range is for after the circuit board is mounted.

○ Halogen-free: Indicates that Cl content is less than 900ppm, Br content is less than 900ppm, and that the total Cl and Br content is less than 1500ppm.

 Please be sure to request delivery specifications that provide further details on the features and specifications of the products for proper and safe use.
Please note that the contents may change without any prior notice due to reasons such as upgrading.

Overview of the ATB Series

RECOMMENDED REFLOW PROFILE

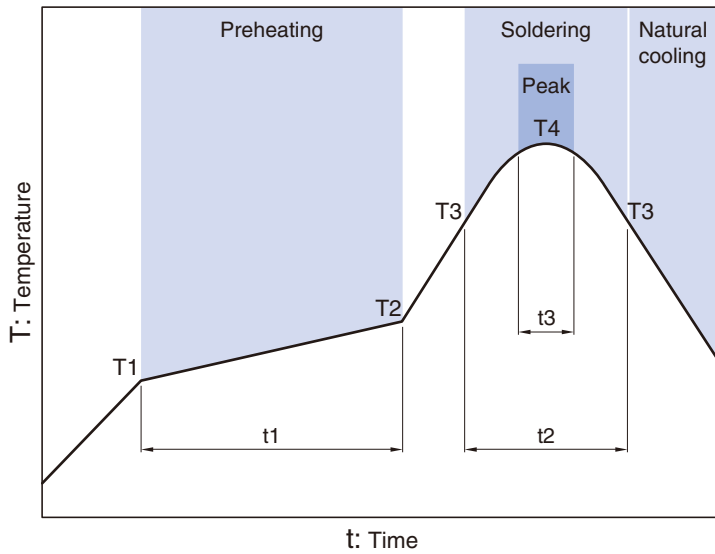

Preheating			Soldering		Peak	
Temp.	Time		Temp.	Time	Temp.	Time
T1	T2	t1	T3	t2	T4	t3
150°C	180°C	60 to 120s	230°C	10 to 30s	245°C	5s max.

ATB series

ATB3225-75011CT Type



SHAPE & DIMENSIONS

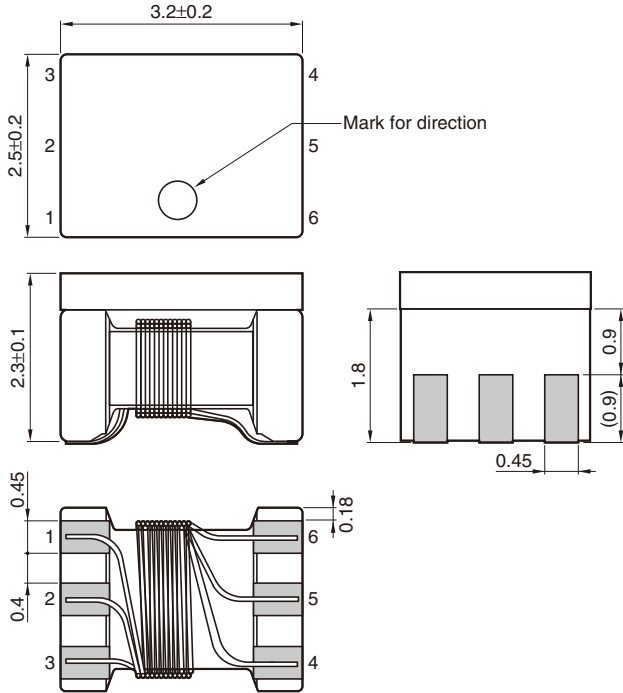

Dimensions in mm

RECOMMENDED LAND PATTERN

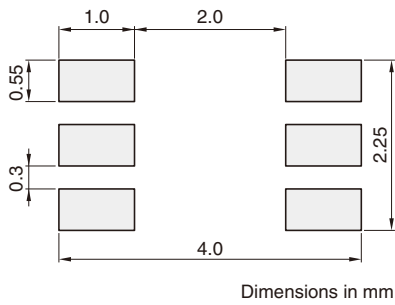

Dimensions in mm

CIRCUIT DIAGRAM

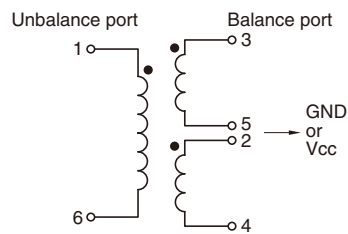

 Please be sure to request delivery specifications that provide further details on the features and specifications of the products for proper and safe use. Please note that the contents may change without any prior notice due to reasons such as upgrading.

ATB series ATB3225-75011CT Type

ELECTRICAL CHARACTERISTICS

CHARACTERISTICS SPECIFICATION TABLE

DC resistance (Ω)max.	Impedance ratio	Frequency range (MHz)	Insertion loss (dB)max.	Return loss (dB)min.	Amplitude unbalance (dB)max.	Phase unbalance (deg.)	Part No.
0.7	1:1 (75 Ω :75 Ω)	5 to 65 5 to 200	0.8 0.5	15 10	0.1 0.5	180 \pm 2 180 \pm 5	ATB3225-75011CT-T001

Measurement equipment

Measurement item	Product No.	Manufacturer
Insertion loss	E5071B	Agilent Technologies
Return loss	E5071B	Agilent Technologies
Amplitude unbalance	E5071B	Agilent Technologies
Phase unbalance	E5071B	Agilent Technologies

* Equivalent measurement equipment may be used.

FREQUENCY CHARACTERISTICS

INSERTION LOSS

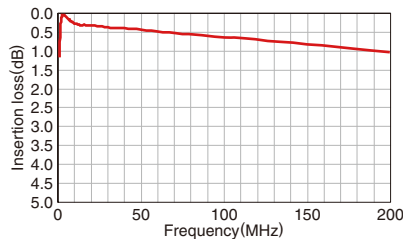

RETURN LOSS

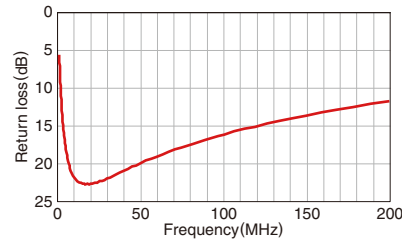

AMPLITUDE UNBALANCE

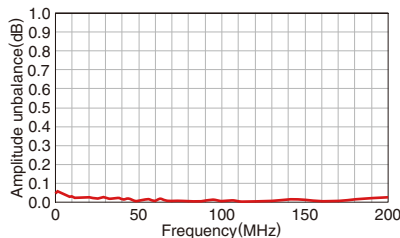

PHASE UNBALANCE

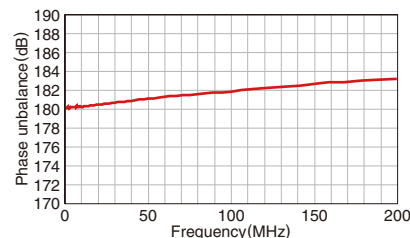

ATB series

ATB3225-75032CT Type



SHAPE & DIMENSIONS

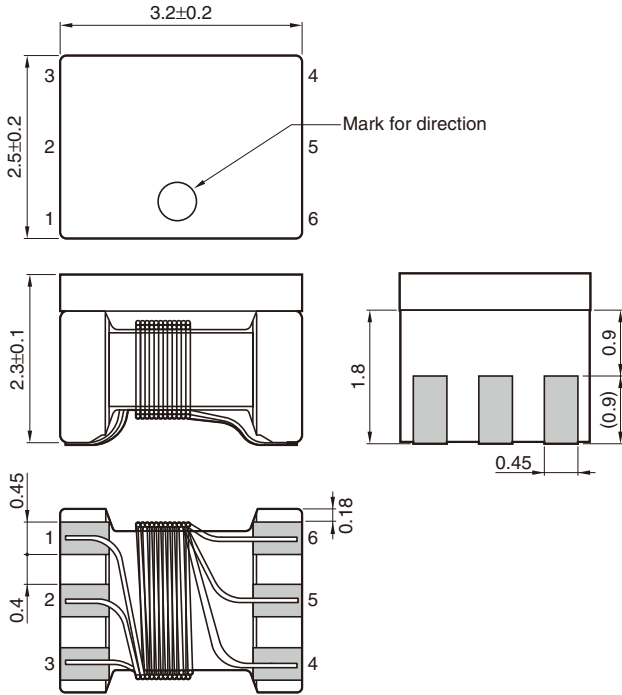

Dimensions in mm

RECOMMENDED LAND PATTERN

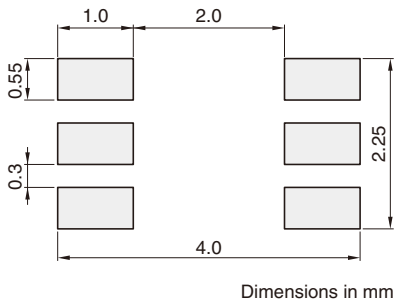

Dimensions in mm

CIRCUIT DIAGRAM

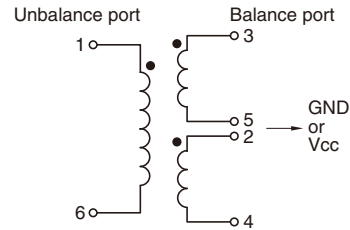

 Please be sure to request delivery specifications that provide further details on the features and specifications of the products for proper and safe use. Please note that the contents may change without any prior notice due to reasons such as upgrading.

ATB series ATB3225-75032CT Type

ELECTRICAL CHARACTERISTICS

CHARACTERISTICS SPECIFICATION TABLE

DC resistance (Ω)max.	Impedance ratio	Frequency range (MHz)	Insertion loss (dB)max.	Return loss (dB)min.	Amplitude unbalance (dB)max.	Phase unbalance (deg.)	Part No.
0.7	3:2 (75 Ω :50 Ω)	5 to 100	2	5	1	180 \pm 10	ATB3225-75032CT-T001

Measurement equipment

Measurement item	Product No.	Manufacturer
Insertion loss	E5071B	Agilent Technologies
Return loss	E5071B	Agilent Technologies
Amplitude unbalance	E5071B	Agilent Technologies
Phase unbalance	E5071B	Agilent Technologies

* Equivalent measurement equipment may be used.

FREQUENCY CHARACTERISTICS

INSERTION LOSS

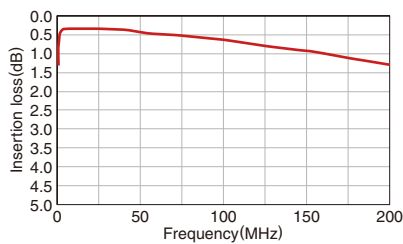

RETURN LOSS

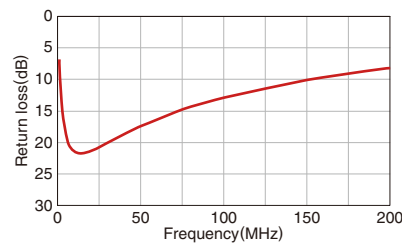

AMPLITUDE BALANCE

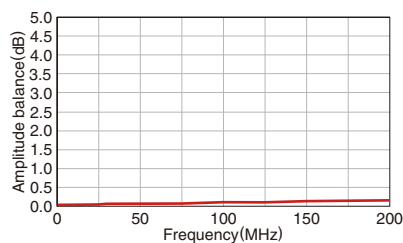

PHASE BALANCE

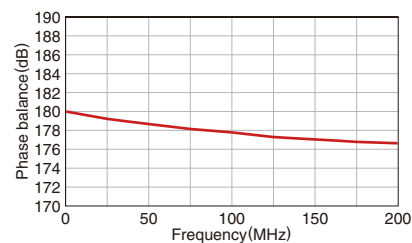

Please be sure to request delivery specifications that provide further details on the features and specifications of the products for proper and safe use. Please note that the contents may change without any prior notice due to reasons such as upgrading.

ATB series

ATB3225-75034CT Type



SHAPE & DIMENSIONS

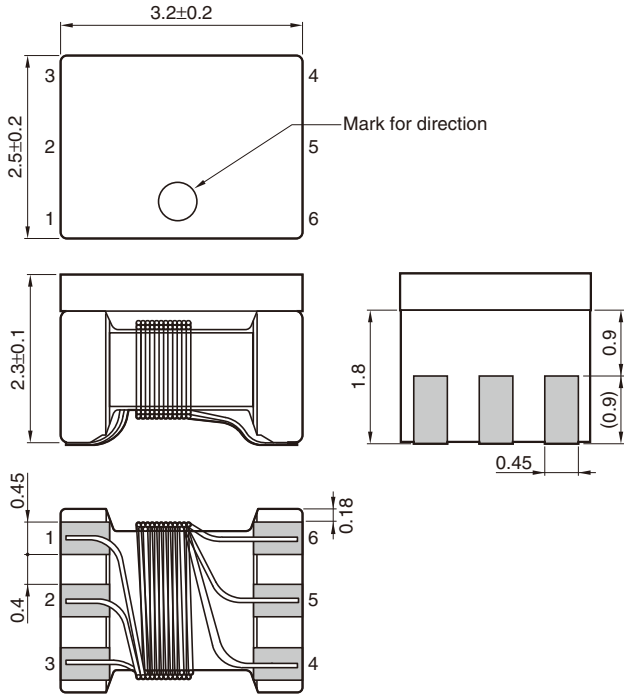

Dimensions in mm

RECOMMENDED LAND PATTERN

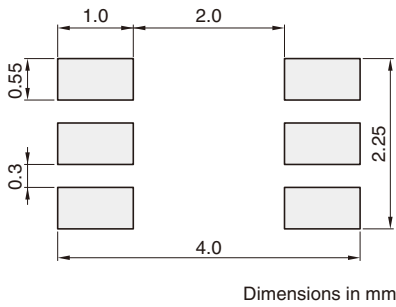

Dimensions in mm

CIRCUIT DIAGRAM

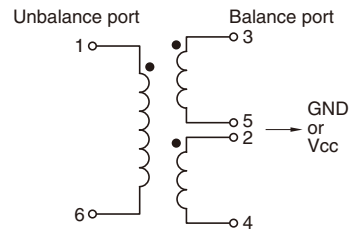

 Please be sure to request delivery specifications that provide further details on the features and specifications of the products for proper and safe use. Please note that the contents may change without any prior notice due to reasons such as upgrading.

ATB series ATB3225-75034CT Type

ELECTRICAL CHARACTERISTICS

CHARACTERISTICS SPECIFICATION TABLE

DC resistance (Ω)max.	Impedance ratio	Frequency range (MHz)	Insertion loss (dB)max.	Return loss (dB)min.	Amplitude unbalance (dB)max.	Phase unbalance (deg.)	Part No.
0.7	3:4 (75Ω:100Ω)	1 to 100	2	5	0.1	180±10	ATB3225-75034CT-T000

Measurement equipment

Measurement item	Product No.	Manufacturer
Insertion loss	E5071B	Agilent Technologies
Return loss	E5071B	Agilent Technologies
Amplitude unbalance	E5071B	Agilent Technologies
Phase unbalance	E5071B	Agilent Technologies

* Equivalent measurement equipment may be used.

FREQUENCY CHARACTERISTICS

INSERTION LOSS

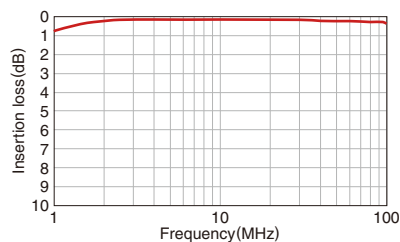

RETURN LOSS

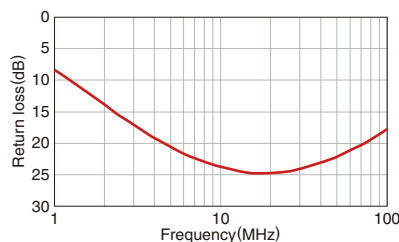

AMPLITUDE IMBALANCE

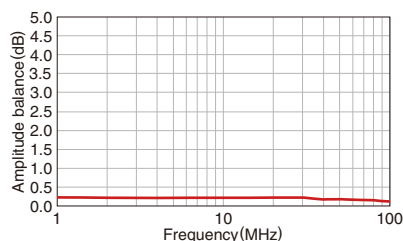

PHASE BALANCE

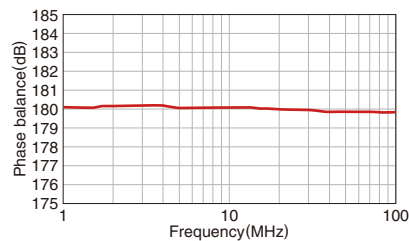

⚠ Please be sure to request delivery specifications that provide further details on the features and specifications of the products for proper and safe use. Please note that the contents may change without any prior notice due to reasons such as upgrading.

ATB series

ATB3225-50011CT Type



SHAPE & DIMENSIONS

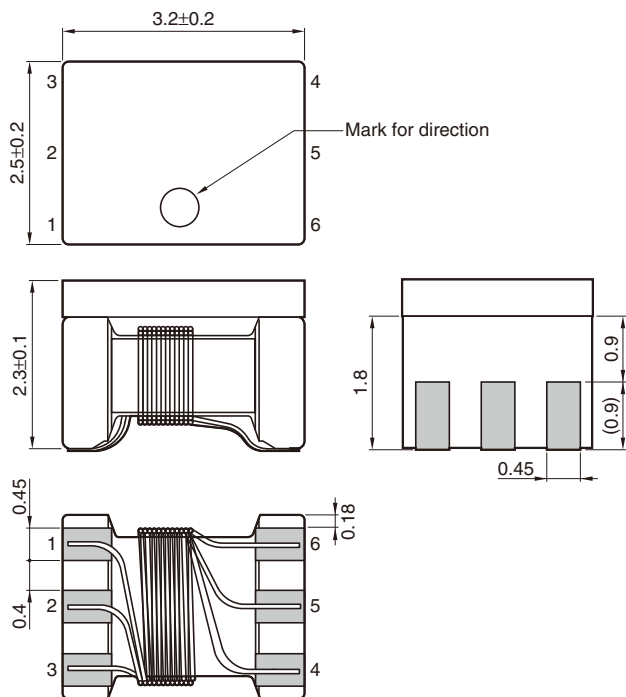

Dimensions in mm

RECOMMENDED LAND PATTERN

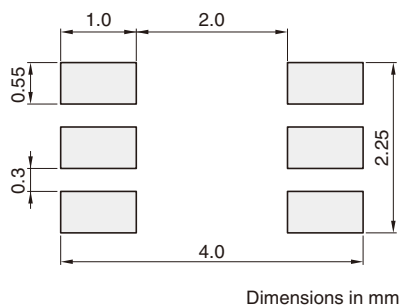

Dimensions in mm

CIRCUIT DIAGRAM

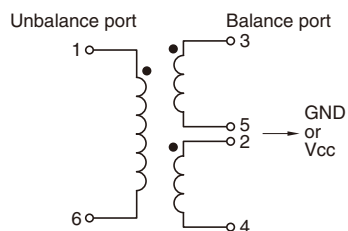

Please be sure to request delivery specifications that provide further details on the features and specifications of the products for proper and safe use. Please note that the contents may change without any prior notice due to reasons such as upgrading.

ATB series ATB3225-50011CT Type

ELECTRICAL CHARACTERISTICS

CHARACTERISTICS SPECIFICATION TABLE

DC resistance (Ω)max.	Impedance ratio	Frequency range (MHz)	Insertion loss (dB)max.	Return loss (dB)min.	Amplitude unbalance (dB)max.	Phase unbalance (deg.)	Part No.
0.7	1:1(50Ω: 50Ω)	1 to 100	1.5	10	0.5	180±5	ATB3225-50011CT-T000

Measurement equipment

Measurement item	Product No.	Manufacturer
Insertion loss	E5071B	Agilent Technologies
Return loss	E5071B	Agilent Technologies
Amplitude unbalance	E5071B	Agilent Technologies
Phase unbalance	E5071B	Agilent Technologies

* Equivalent measurement equipment may be used.

FREQUENCY CHARACTERISTICS

INSERTION LOSS

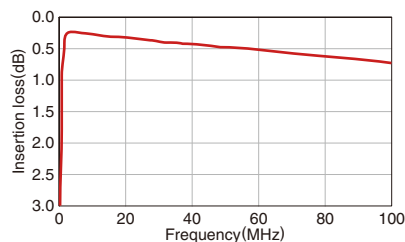

RETURN LOSS

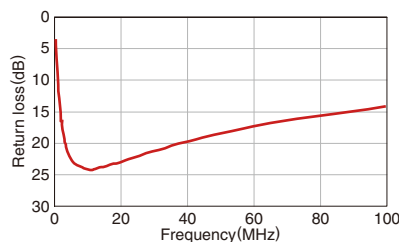

AMPLITUDE IMBALANCE

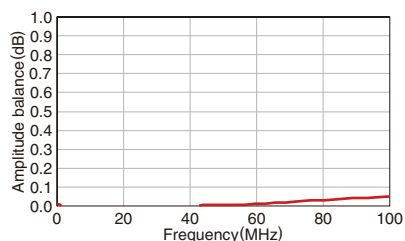

PHASE BALANCE

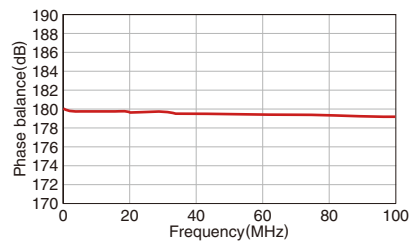

⚠ Please be sure to request delivery specifications that provide further details on the features and specifications of the products for proper and safe use. Please note that the contents may change without any prior notice due to reasons such as upgrading.

ATB series

Packaging style

REEL DIMENSIONS

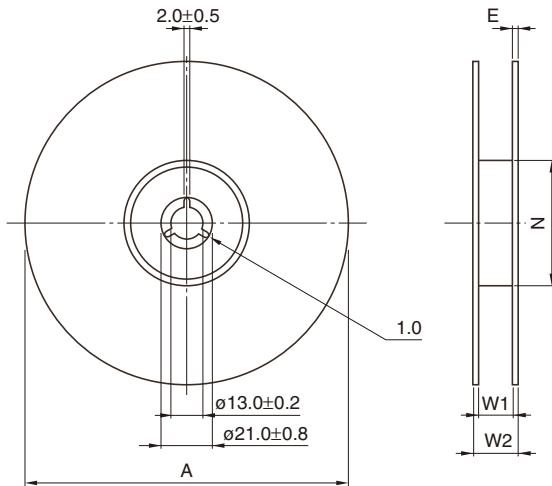

Dimensions in mm

Type	A	W1	W2	N	E
ATB3225-75011CT	ø180+0/-1.5	9+1/-0	13±1	60+1/-0	2 typ.
ATB3225-75032CT	ø180+0/-1.5	9+1/-0	13±1	60+1/-0	2 typ.
ATB3225-75034CT	ø180+0/-1.5	9+1/-0	13±1	60+1/-0	2 typ.
ATB3225-50011CT	ø180+0/-1.5	9+1/-0	13±1	60+1/-0	2 typ.

TAPE DIMENSIONS

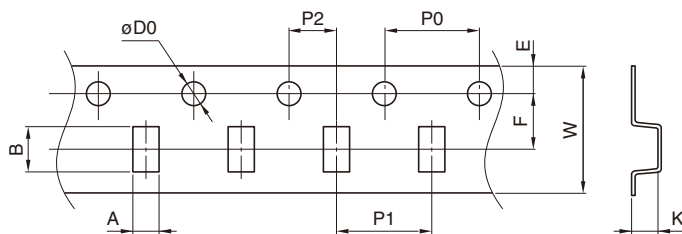

Dimensions in mm

Type	A	B	øD0	E	F	P0	P1	P2	W	K
ATB3225-75011CT	2.9±0.1	3.6±0.1	1.5+0.1/0	1.75±0.1	3.5±0.05	4.0±0.1	4.0±0.1	2.0±0.05	8.0±0.2	2.5±0.05
ATB3225-75032CT	2.9±0.1	3.6±0.1	1.5+0.1/0	1.75±0.1	3.5±0.05	4.0±0.1	4.0±0.1	2.0±0.05	8.0±0.2	2.5±0.05
ATB3225-75034CT	2.9±0.1	3.6±0.1	1.5+0.1/0	1.75±0.1	3.5±0.05	4.0±0.1	4.0±0.1	2.0±0.05	8.0±0.2	2.5±0.05
ATB3225-50011CT	2.9±0.1	3.6±0.1	1.5+0.1/0	1.75±0.1	3.5±0.05	4.0±0.1	4.0±0.1	2.0±0.05	8.0±0.2	2.5±0.05

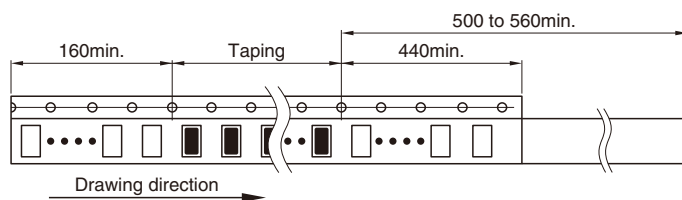

Dimensions in mm

⚠ Please be sure to request delivery specifications that provide further details on the features and specifications of the products for proper and safe use.
Please note that the contents may change without any prior notice due to reasons such as upgrading.