



Is Now Part of



**ON Semiconductor®**

To learn more about ON Semiconductor, please visit our website at  
[www.onsemi.com](http://www.onsemi.com)

ON Semiconductor and the ON Semiconductor logo are trademarks of Semiconductor Components Industries, LLC dba ON Semiconductor or its subsidiaries in the United States and/or other countries. ON Semiconductor owns the rights to a number of patents, trademarks, copyrights, trade secrets, and other intellectual property. A listing of ON Semiconductor's product/patent coverage may be accessed at [www.onsemi.com/site/pdf/Patent-Marking.pdf](http://www.onsemi.com/site/pdf/Patent-Marking.pdf). ON Semiconductor reserves the right to make changes without further notice to any products herein. ON Semiconductor makes no warranty, representation or guarantee regarding the suitability of its products for any particular purpose, nor does ON Semiconductor assume any liability arising out of the application or use of any product or circuit, and specifically disclaims any and all liability, including without limitation special, consequential or incidental damages. Buyer is responsible for its products and applications using ON Semiconductor products, including compliance with all laws, regulations and safety requirements or standards, regardless of any support or applications information provided by ON Semiconductor. "Typical" parameters which may be provided in ON Semiconductor data sheets and/or specifications can and do vary in different applications and actual performance may vary over time. All operating parameters, including "Typicals" must be validated for each customer application by customer's technical experts. ON Semiconductor does not convey any license under its patent rights nor the rights of others. ON Semiconductor products are not designed, intended, or authorized for use as a critical component in life support systems or any FDA Class 3 medical devices or medical devices with a same or similar classification in a foreign jurisdiction or any devices intended for implantation in the human body. Should Buyer purchase or use ON Semiconductor products for any such unintended or unauthorized application, Buyer shall indemnify and hold ON Semiconductor and its officers, employees, subsidiaries, affiliates, and distributors harmless against all claims, costs, damages, and expenses, and reasonable attorney fees arising out of, directly or indirectly, any claim of personal injury or death associated with such unintended or unauthorized use, even if such claim alleges that ON Semiconductor was negligent regarding the design or manufacture of the part. ON Semiconductor is an Equal Opportunity/Affirmative Action Employer. This literature is subject to all applicable copyright laws and is not for resale in any manner.



# HMHAA280

## AC Input, Half Pitch Mini-Flat Package 4-Pin Optocoupler

### Features

- Compact 4-pin package (2.4mm maximum standoff height)
- Half pitch leads for optimum board space savings
- Current Transfer Ratio: 50–600%
- Available in tape and reel quantities of 2500
- CSA (File #1201524), UL (File #E90700) and VDE (File #136480) certified

### Description

The HMHAA280 series consists of two gallium arsenide infrared emitting diodes, connected in inverse parallel, driving a single silicon phototransistor in a compact 4-pin mini-flat package. The lead pitch is 1.27mm.

### Applications

- AC line monitor
- Unknown polarity DC sensor
- Telephone line receiver

### Package Dimensions

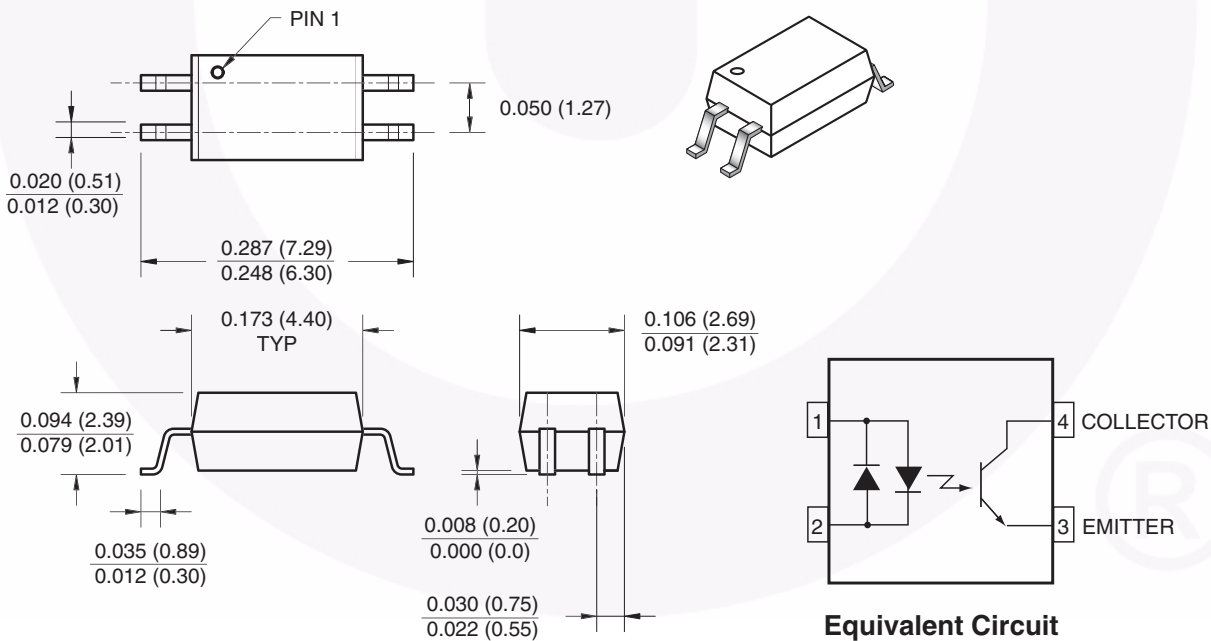

**Note:**

All dimensions are in inches (millimeters)

**Absolute Maximum Ratings** ( $T_A = 25^\circ\text{C}$  unless otherwise specified)

Stresses exceeding the absolute maximum ratings may damage the device. The device may not function or be operable above the recommended operating conditions and stressing the parts to these levels is not recommended. In addition, extended exposure to stresses above the recommended operating conditions may affect device reliability. The absolute maximum ratings are stress ratings only.

Symbol	Parameter	Value	Units
<b>TOTAL PACKAGE</b>			
$T_{\text{STG}}$	Storage Temperature	-55 to +125	$^\circ\text{C}$
$T_{\text{OPR}}$	Operating Temperature	-55 to +100	$^\circ\text{C}$
<b>EMITTER</b>			
$I_{\text{F (avg)}}$	Continuous Forward Current	50	mA
$I_{\text{F (pk)}}$	Peak Forward Current (1 $\mu\text{s}$ pulse, 300pps.)	1	A
$V_{\text{R}}$	Reverse Input Voltage	6	V
$P_{\text{D}}$	Power Dissipation	60	mW
	Derate linearly (above $25^\circ\text{C}$ )	0.6	mW/ $^\circ\text{C}$
<b>DETECTOR</b>			
	Continuous Collector Current	50	mA
$P_{\text{D}}$	Power Dissipation	150	mW
	Derate linearly (above $25^\circ\text{C}$ )	1.5	mW/ $^\circ\text{C}$
$V_{\text{CEO}}$	Collector-Emitter Voltage	80	V
$V_{\text{ECO}}$	Emitter-Collector Voltage	7	V

**Electrical Characteristics** ( $T_A = 25^\circ\text{C}$ )

Symbol	Parameter	Test Conditions	Min.	Typ.*	Max.	Unit
<b>INDIVIDUAL COMPONENT CHARACTERISTICS</b>						
<b>Emitter</b>						
$V_F$	Forward Voltage	$I_F = \pm 5\text{mA}$			1.4	V
$I_R$	Reverse Current	$V_R = 5\text{V}$			5	$\mu\text{A}$
<b>Detector</b>						
$BV_{CEO}$	Breakdown Voltage Collector to Emitter	$I_C = 0.5\text{mA}, I_F = 0$	80			V
$BV_{ECO}$	Emitter to Collector	$I_E = 100\mu\text{A}, I_F = 0$	7			
$I_{CEO}$	Collector Dark Current	$V_{CE} = 80\text{V}, I_F = 0$			100	nA
$C_{CE}$	Capacitance	$V_{CE} = 0\text{V}, f = 1\text{MHz}$		10		pF
<b>TRANSFER CHARACTERISTICS</b>						
CTR	DC Current Transfer Ratio	$I_F = \pm 5\text{mA}, V_{CE} = 5\text{V}$	50		600	%
	CTR Symmetry	$I_F = \pm 5\text{mA}, V_{CE} = 5\text{V}$	0.33		3.0	
$V_{CE(SAT)}$	Saturation Voltage	$I_F = \pm 8\text{mA}, I_C = 2.4\text{mA}$			0.4	V
$t_r$	Rise Time (Non-Saturated)	$I_C = 2\text{mA}, V_{CE} = 5\text{V}, R_L = 100\Omega$		3		$\mu\text{s}$
$t_f$	Fall Time (Non-Saturated)	$I_C = 2\text{mA}, V_{CE} = 5\text{V}, R_L = 100\Omega$		3		
<b>ISOLATION CHARACTERISTICS</b>						
$V_{ISO}$	Steady State Isolation Voltage	1 Minute	3750			VRMS

\*All typicals at  $T_A = 25^\circ\text{C}$

## Typical Performance Characteristics

Fig. 1 Forward Current vs. Forward Voltage

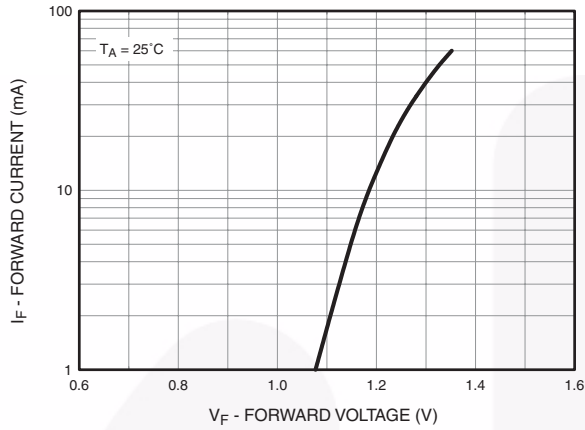

Fig. 2 Collector Current vs. Forward Current

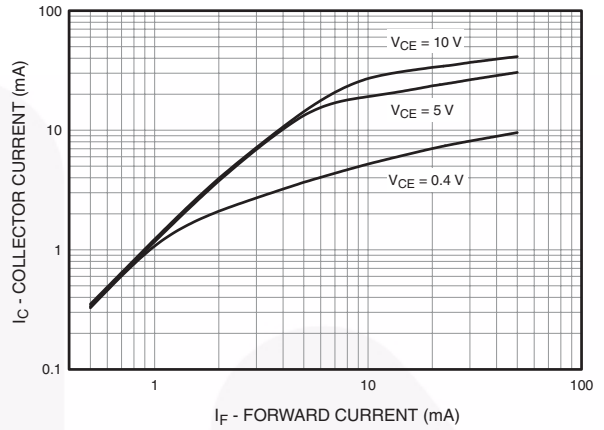

Fig. 3 Current Transfer Ratio vs. Forward Current

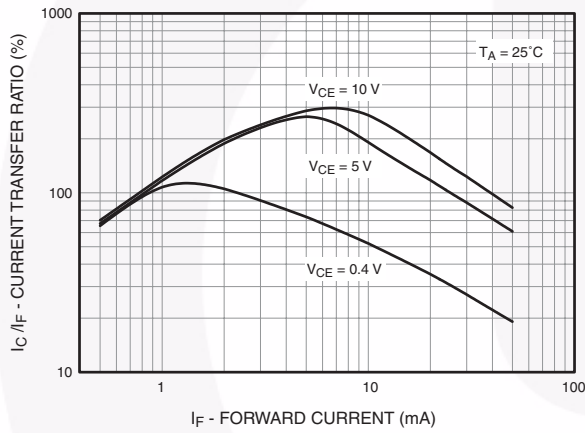

Fig. 4 Normalized CTR vs. Temperature

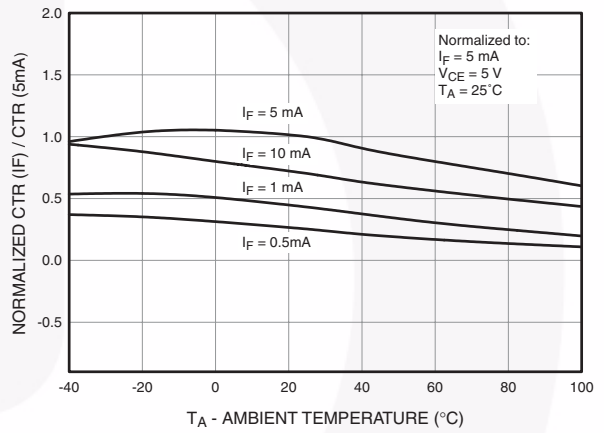
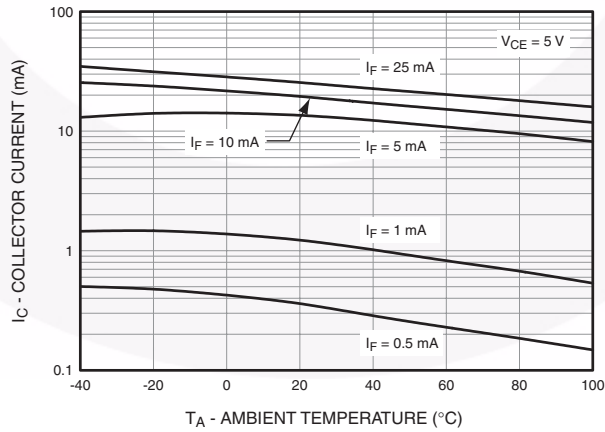
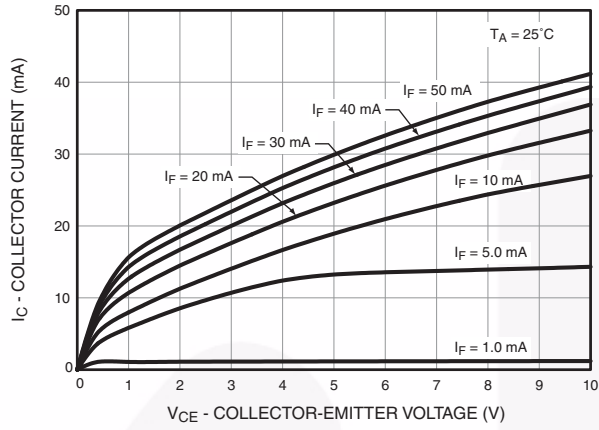

Fig. 5 Collector Current vs. Temperature



**Typical Performance Characteristics (Continued)**

**Fig. 6 Collector Current vs. Collector-Emitter Voltage**



**Fig. 7 Collector Current vs. Collector-Emitter Voltage**

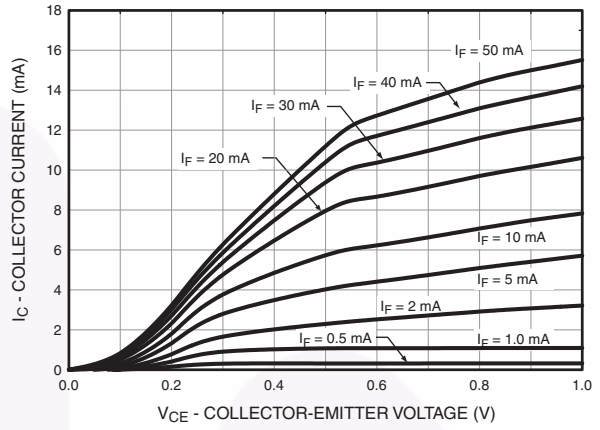

**Fig. 8 Collector Dark Current vs. Temperature**

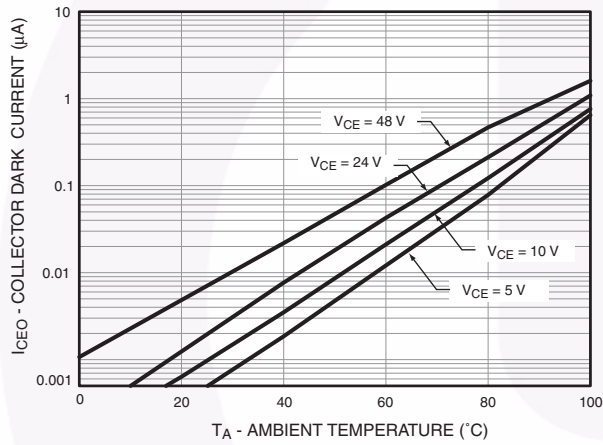

**Fig. 9 Switching Time vs. Load Resistance**

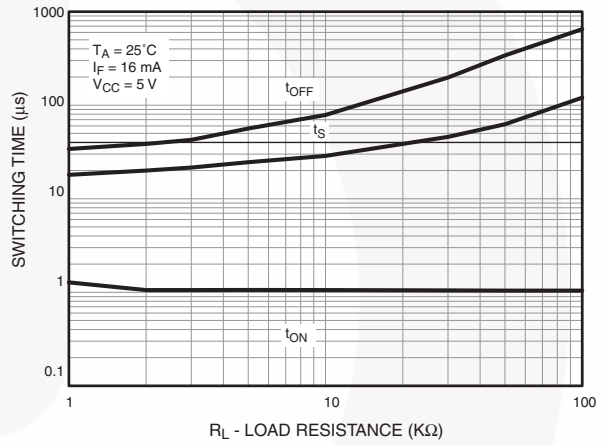

**Fig. 10 Collector-Emitter Saturation Voltage vs. Temperature**

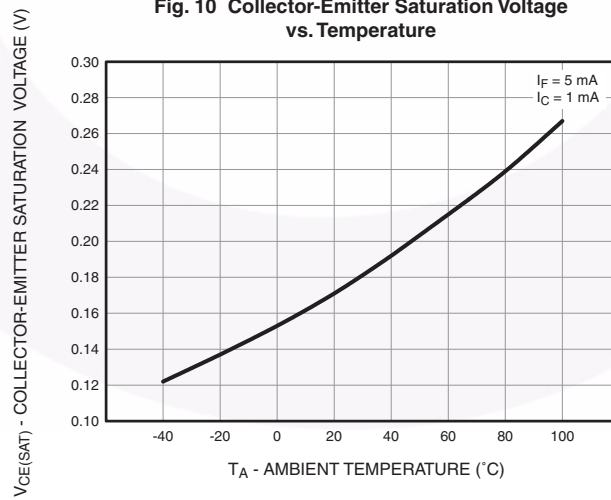

### Ordering Information

Option	Description
V	VDE Approved
R2	Tape and Reel (2500 units)
R2V	Tape and Reel (2500 units) and VDE Approved

### Marking Information

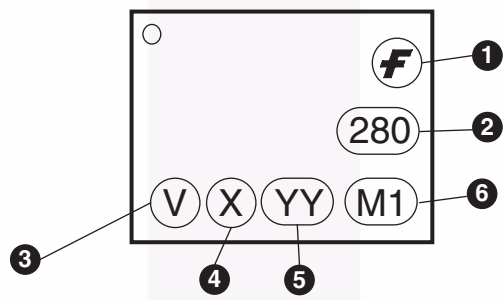

Definitions	
1	Fairchild logo
2	Device number
3	VDE mark (Note: Only appears on parts ordered with VDE option – See order entry table)
4	One digit year code
5	Two digit work week ranging from '01' to '53'
6	Assembly package code

## Tape and Reel Dimensions

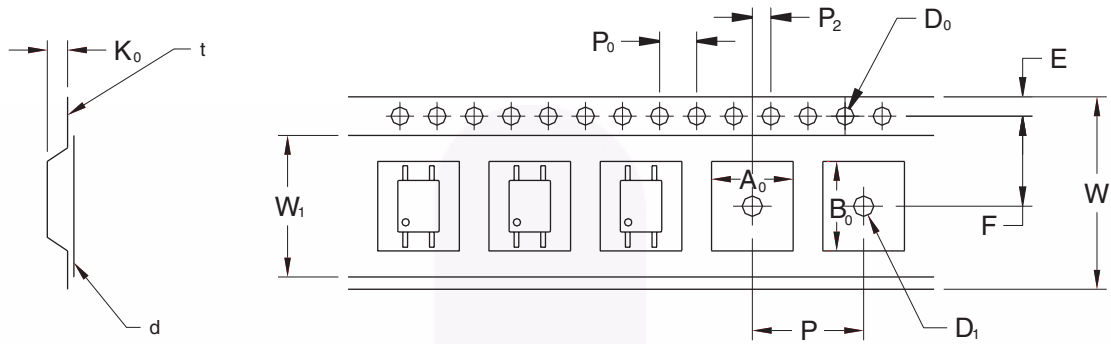

		1.27 Pitch
Description	Symbol	Dimensions (mm)
Tape Width	W	12.00 +0.30/-0.10
Tape Thickness	t	0.30 ±0.05
Sprocket Hole Pitch	P <sub>0</sub>	4.00 ±0.10
Sprocket Hole Diameter	D <sub>0</sub>	1.50 +0.10/-0.0
Sprocket Hole Location	E	1.75 ±0.10
Pocket Location	F	5.50 ±0.10
	P <sub>2</sub>	2.00 ±0.10
Pocket Pitch	P	8.00 ±0.10
Pocket Dimension	A <sub>0</sub>	2.80 ±0.10
	B <sub>0</sub>	7.30 ±0.10
	K <sub>0</sub>	2.30 ±0.10
Pocket Hole Diameter	D <sub>1</sub>	1.50 Min.
Cover Tape Width	W <sub>1</sub>	9.20
Cover Tape Thickness	d	0.065 ±0.010
Max. Component Rotation or Tilt		10° Max.
Devices Per Reel		2500
Reel Diameter		330mm (13")



### Footprint Drawing for PCB Layout

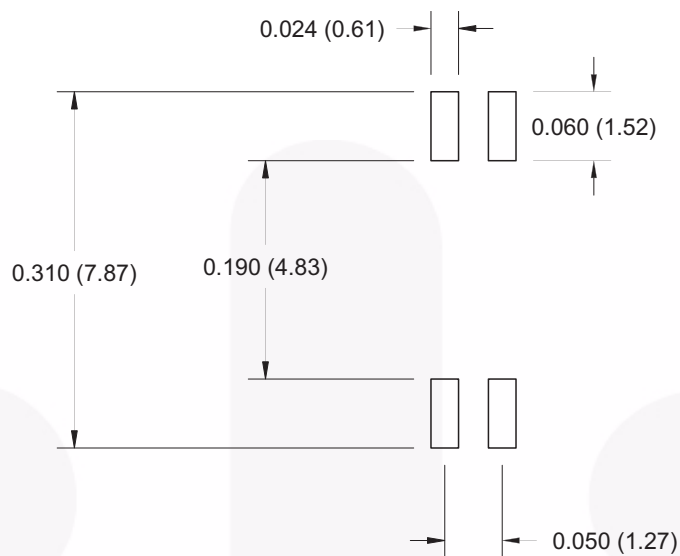

### Reflow Profile0

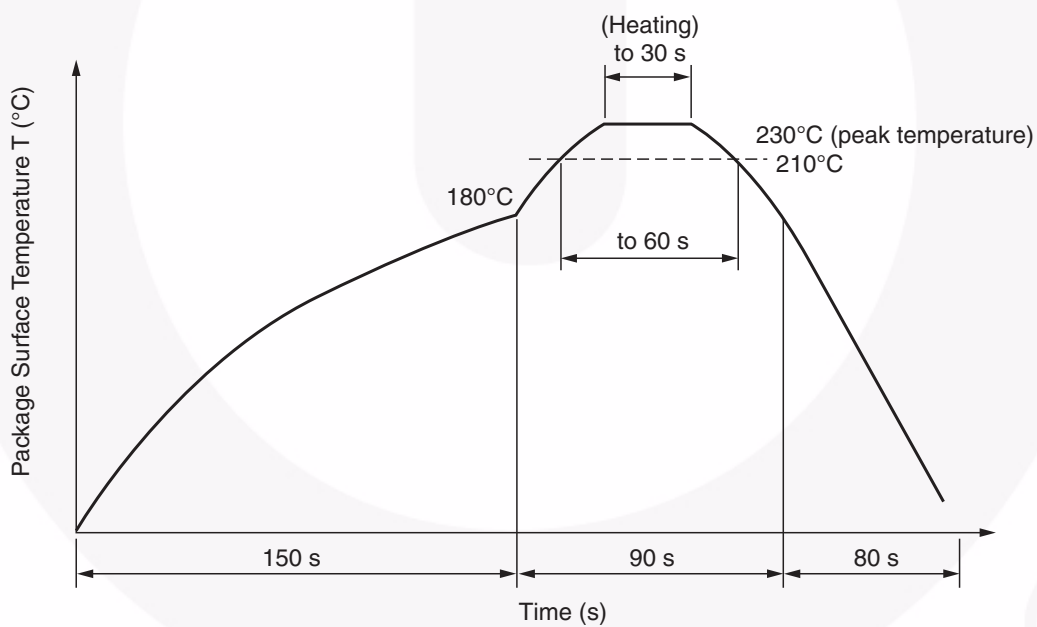

- Peak reflow temperature: 230°C (package surface temperature) for 30 seconds
- Time of temperature higher than 210°C: 60 seconds or less
- One time soldering reflow is recommended

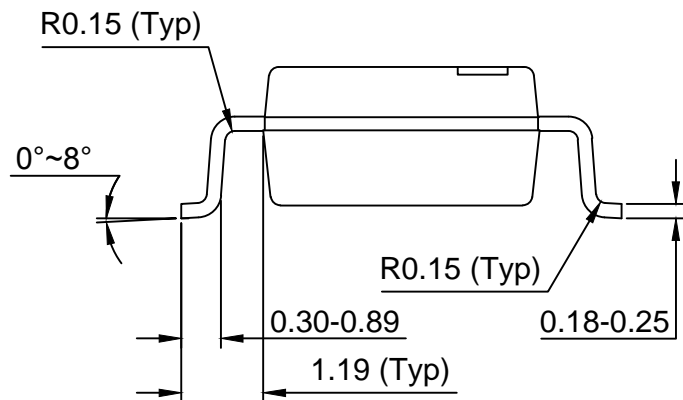
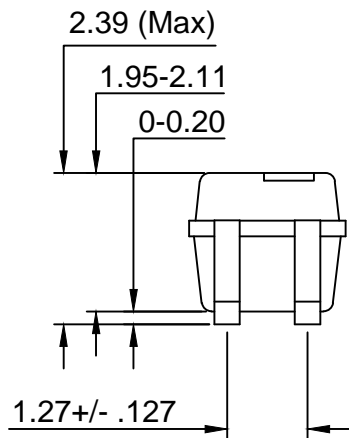

NOTES:

- A) NO STANDARD APPLIES TO THIS PACKAGE
- B) ALL DIMENSIONS ARE IN MILLIMETERS.
- C) DIMENSIONS ARE EXCLUSIVE OF BURRS, MOLD FLASH, AND TIE BAR EXTRUSION
- D) DRAWING FILENAME AND REVISION : MKT-MFP04AREV4.



ON Semiconductor and  are trademarks of Semiconductor Components Industries, LLC dba ON Semiconductor or its subsidiaries in the United States and/or other countries. ON Semiconductor owns the rights to a number of patents, trademarks, copyrights, trade secrets, and other intellectual property. A listing of ON Semiconductor's product/patent coverage may be accessed at [www.onsemi.com/site/pdf/Patent-Marking.pdf](http://www.onsemi.com/site/pdf/Patent-Marking.pdf). ON Semiconductor reserves the right to make changes without further notice to any products herein. ON Semiconductor makes no warranty, representation or guarantee regarding the suitability of its products for any particular purpose, nor does ON Semiconductor assume any liability arising out of the application or use of any product or circuit, and specifically disclaims any and all liability, including without limitation special, consequential or incidental damages. Buyer is responsible for its products and applications using ON Semiconductor products, including compliance with all laws, regulations and safety requirements or standards, regardless of any support or applications information provided by ON Semiconductor. "Typical" parameters which may be provided in ON Semiconductor data sheets and/or specifications can and do vary in different applications and actual performance may vary over time. All operating parameters, including "Typicals" must be validated for each customer application by customer's technical experts. ON Semiconductor does not convey any license under its patent rights nor the rights of others. ON Semiconductor products are not designed, intended, or authorized for use as a critical component in life support systems or any FDA Class 3 medical devices or medical devices with a same or similar classification in a foreign jurisdiction or any devices intended for implantation in the human body. Should Buyer purchase or use ON Semiconductor products for any such unintended or unauthorized application, Buyer shall indemnify and hold ON Semiconductor and its officers, employees, subsidiaries, affiliates, and distributors harmless against all claims, costs, damages, and expenses, and reasonable attorney fees arising out of, directly or indirectly, any claim of personal injury or death associated with such unintended or unauthorized use, even if such claim alleges that ON Semiconductor was negligent regarding the design or manufacture of the part. ON Semiconductor is an Equal Opportunity/Affirmative Action Employer. This literature is subject to all applicable copyright laws and is not for resale in any manner.

## PUBLICATION ORDERING INFORMATION

### LITERATURE FULFILLMENT:

Literature Distribution Center for ON Semiconductor  
19521 E. 32nd Pkwy, Aurora, Colorado 80011 USA  
**Phone:** 303-675-2175 or 800-344-3860 Toll Free USA/Canada  
**Fax:** 303-675-2176 or 800-344-3867 Toll Free USA/Canada  
**Email:** [orderlit@onsemi.com](mailto:orderlit@onsemi.com)

**N. American Technical Support:** 800-282-9855 Toll Free  
USA/Canada  
**Europe, Middle East and Africa Technical Support:**  
Phone: 421 33 790 2910  
**Japan Customer Focus Center**  
Phone: 81-3-5817-1050

**ON Semiconductor Website:** [www.onsemi.com](http://www.onsemi.com)  
**Order Literature:** <http://www.onsemi.com/orderlit>  
For additional information, please contact your local  
Sales Representative