

CDSV3-16-G/56-G/70-G/99-G

Reverse Voltage: 75 Volts
Forward Current: 300 mA
RoHS Device

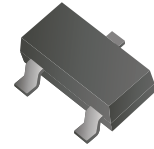

Features

- Design for mounting on small surface.
- High speed switching.
- High mounting capability, strong surge withstand, high reliability.

Mechanical data

- Case: SOT-323, molded plastic.
- Terminals: solderable per MIL-STD-750, method 2026.
- Approx. weight: 0.006 grams

Circuit diagram

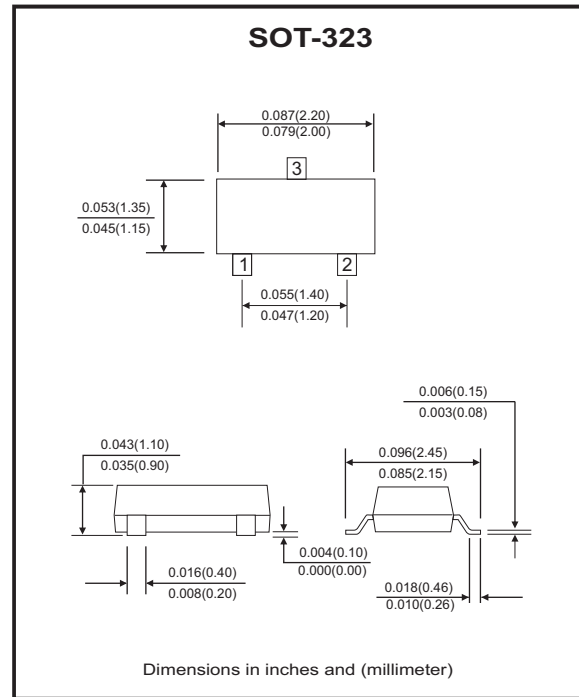
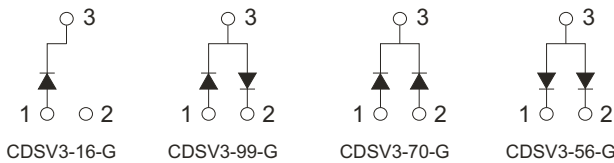

Maximum Ratings and Electrical Characteristics

(at Ta=25°C unless otherwise noted)

Parameter	Symbol	Conditions	Value	Units
Repetitive peak reverse voltage	V_{RRM}		75	V
Reverse voltage	V_R		75	V
Forward current	I_F		300	mA
Peak surge forward current	I_{FSM}	T=1.0 μ S	2	A
Power dissipation	P_D		200	mW
Maximum forward voltage	V_F	@ I_F =1mA @ I_F =10mA @ I_F =50mA @ I_F =150mA	0.715 0.855 1.0 1.25	V
Maximum reverse current	I_R	@ V_R =20V @ V_R =75V @ V_R =25V, T_J =150 °C @ V_R =75V, T_J =150 °C	0.025 2.5 30 50	μ A
Maximum reverse recovery time	T_{rr}	I_F =10mA, V_R =6V	4	nS
Typical diode capacitance	C_J	V_R =0V, f=1.0MHz	2	pF
Maximum junction temperature	T_J		-65~+150	°C
Storage temperature	T_{STG}		-65 to +150	°C

Company reserves the right to improve product design , functions and reliability without notice.

REV:C

RATING AND CHARACTERISTIC CURVES (CDSV3-16-G/56-G/70-G/99-G)

Fig.1 - Forward Characteristics

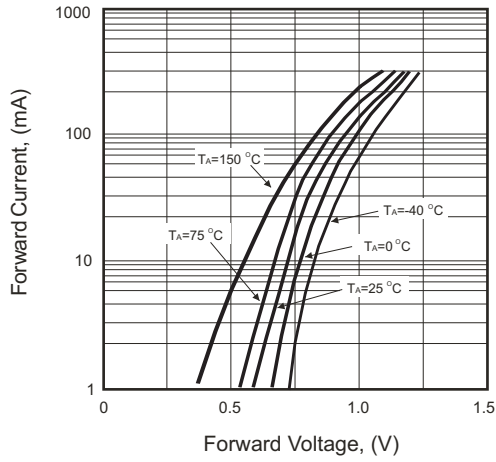

Fig.2 - Typical Reverse Characteristics

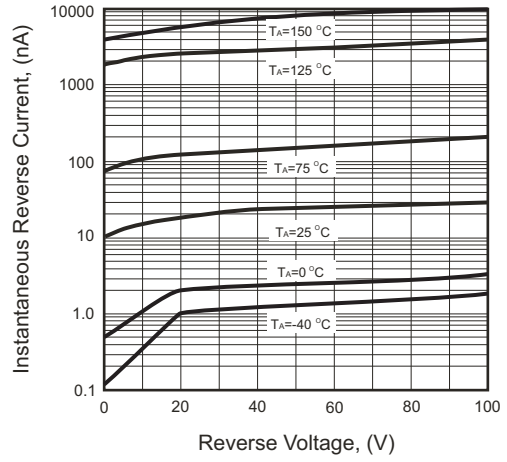

Fig.3 - Typical Capacitance vs. Reverse Voltage

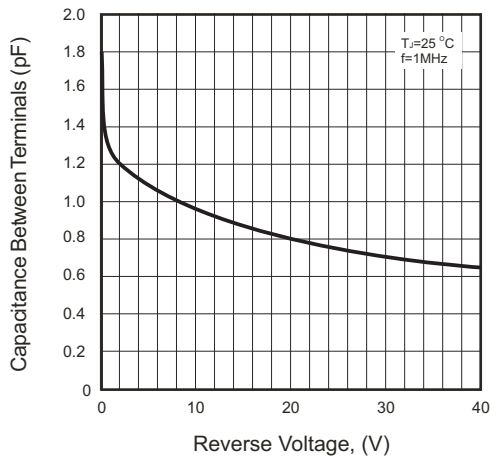

Fig.4 - Reverse Recovery Time vs. Forward Current

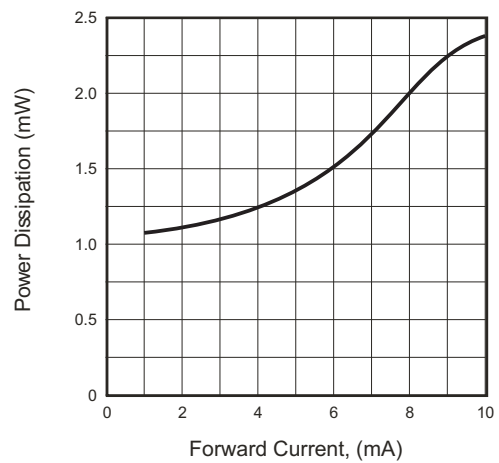
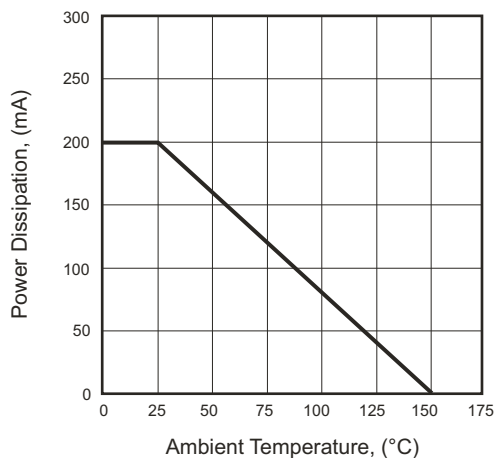
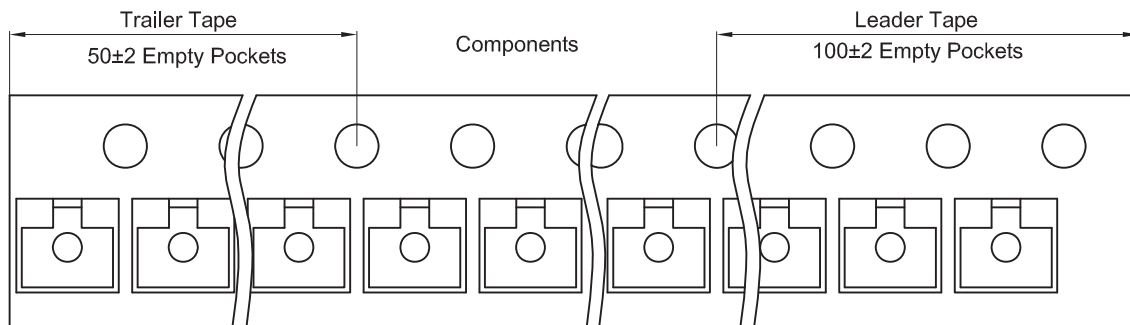
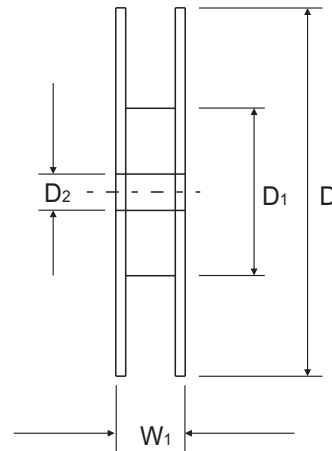
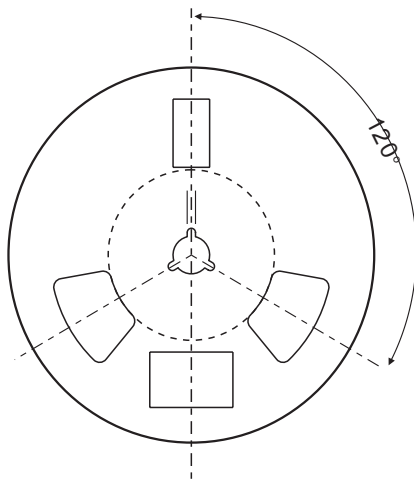
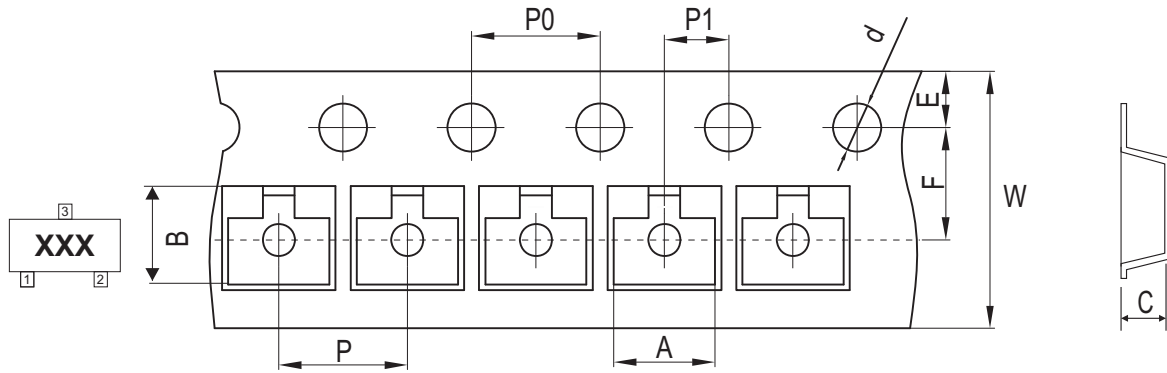

Fig.5 - Power Derating Curve, Total Package



Reel Taping Specification



SOT-323	SYMBOL	A	B	C	d	D	D1	D2
	(mm)	2.25 ± 0.05	2.55 ± 0.05	1.19 ± 0.05	1.55 ± 0.10	178 ± 2.00	54.40 ± 1.00	13.00 ± 1.00
	(inch)	0.089 ± 0.002	0.100 ± 0.002	0.047 ± 0.002	0.061 ± 0.004	7.008 ± 0.079	2.142 ± 0.039	0.512 ± 0.039

SOT-323	SYMBOL	E	F	P	P0	P1	W	W1
	(mm)	1.75 ± 0.10	3.50 ± 0.10	4.00 ± 0.10	4.00 ± 0.10	2.00 ± 0.10	8.00 + 0.30 / - 0.10	12.30 ± 1.00
	(inch)	0.069 ± 0.004	0.138 ± 0.004	0.157 ± 0.004	0.157 ± 0.004	0.079 ± 0.004	0.315 + 0.012 / - 0.004	0.484 ± 0.039

Marking Code

Part Number	Marking Code
CDBV3-16-G	A2
CDBV3-56-G	KJC
CDBV3-70-G	KJA
CDBV3-99-G	KJG

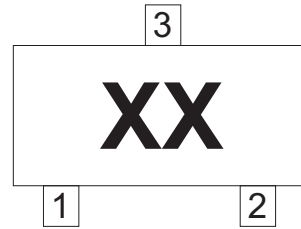

xx/xxx = Product type marking code

Suggested PAD Layout

SIZE	SOT-323	
	(mm)	(inch)
A	0.80	0.031
B	0.50	0.020
C	1.30	0.051
D	2.20	0.087

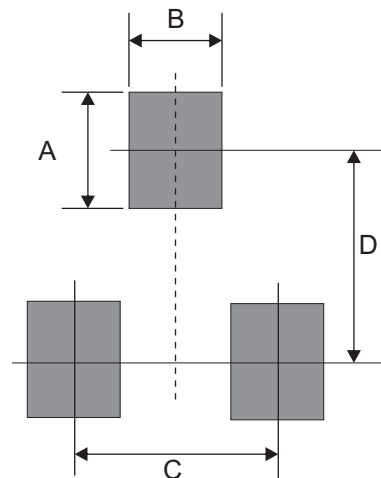

Standard Packaging

Case Type	REEL PACK	
	REEL (pcs)	Reel Size (inch)
SOT-323	3,000	7