

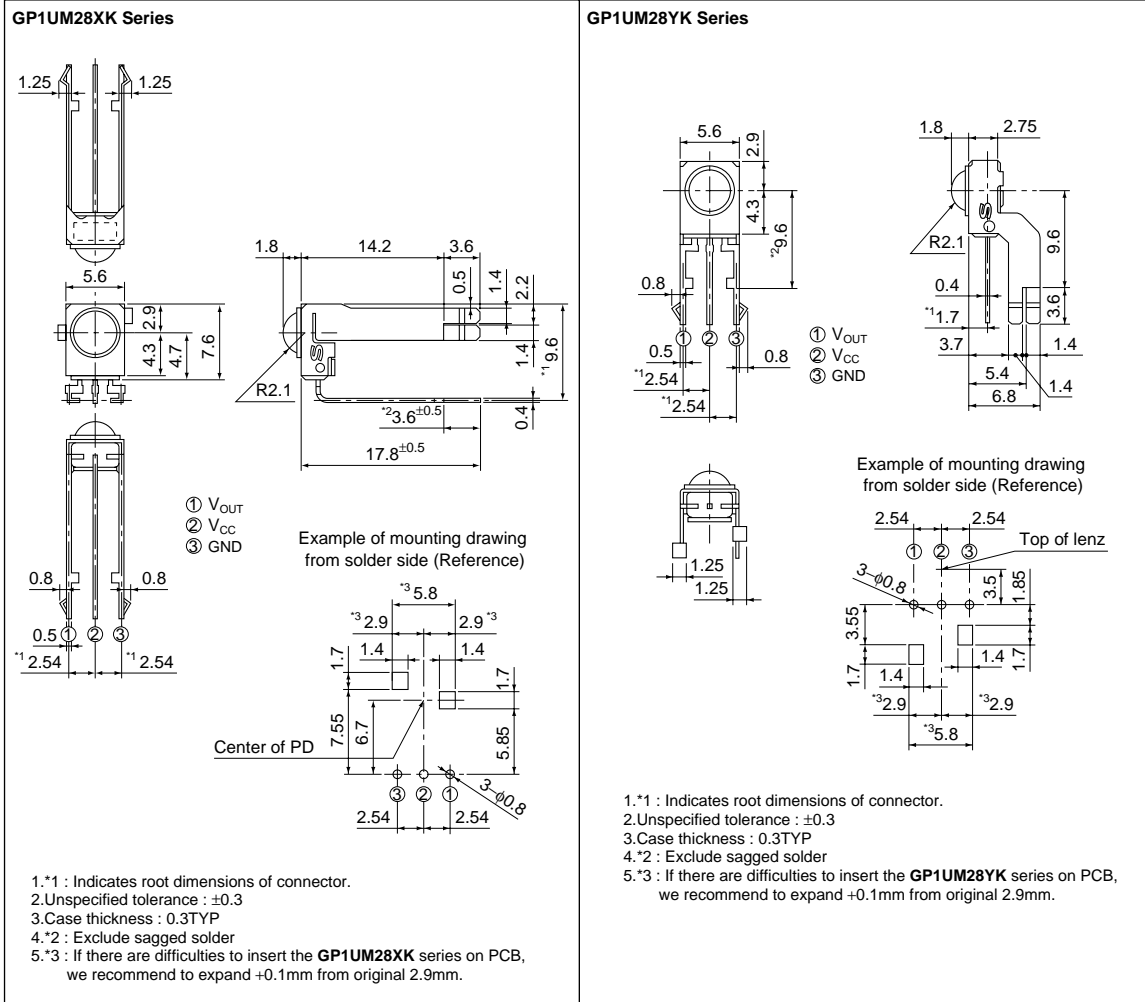

■ Outline Dimensions

(Unit : mm)



■ Model Line-up

Diversified models with a different B.P.F. frequency are also available.

B.P.F. center frequency	Model No.				Unit
40	GP1UM26XK	GP1UM27XK	GP1UM28XK	GP1UM28YK	kHz
36	GP1UM260XK	GP1UM270XK	GP1UM280XK	GP1UM280YK	
38	GP1UM261XK	GP1UM271XK	GP1UM281XK	GP1UM281YK	
36.7	GP1UM262XK	GP1UM272XK	GP1UM282XK	GP1UM282YK	
56.8	GP1UM267XK	GP1UM277XK	GP1UM287XK	GP1UM287YK	

Internal Block Diagram

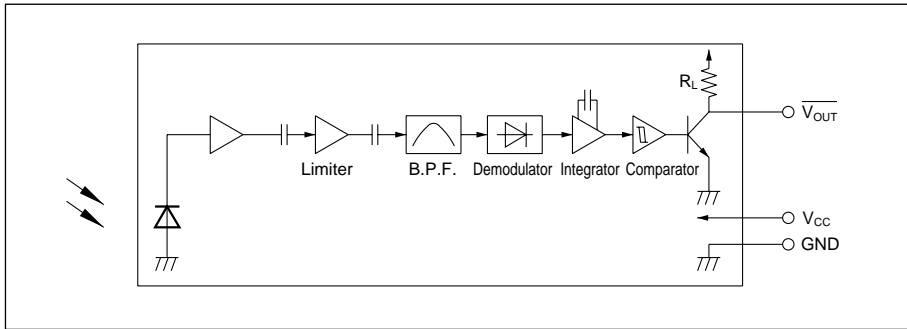

Absolute Maximum Ratings (Ta=25°C)

Parameter	Symbol	Rating	Unit
Supply voltage	V <sub>CC</sub>	0 to +6.0	V
*1 Operating temperature	T <sub>opr</sub>	-10 to +70	°C
Storage temperature	T <sub>stg</sub>	-20 to +70	°C
*2 Soldering temperature	T <sub>sol</sub>	260	°C

\*1 No dew condensation is allowed

\*2 For 5s (At mounting on PCB with thickness of 1.6mm)

Recommended Operating Conditions

Parameter	Symbol	Operating conditions	Unit
Supply voltage	V <sub>CC</sub>	4.5 to 5.5	V

Electro-optical Characteristics (Ta=25°C, VCC=5V)

Parameter	Symbol	Conditions	MIN.	TYP.	MAX.	Unit
Dissipation current	I <sub>CC</sub>	No input light	-	0.95	1.5	mA
High level output voltage	V <sub>OH</sub>	*3	V <sub>CC</sub> -0.5	-	-	V
Low level output voltage	V <sub>OL</sub>	*3 I <sub>OL</sub> =1.6mA	-	-	0.45	V
High level pulse width	T <sub>1</sub>	*3	600	-	1 200	µs
Low level pulse width	T <sub>2</sub>	*3	400	-	1 000	µs
B.P.F. center frequency	f <sub>0</sub>	-	-	*4	-	kHz
Output pull-up resistance	R <sub>L</sub>	-	70	100	130	kΩ

\*3 The burst wave as shown in the following figure shall be transmitted by the transmitter shown in Fig. 1

The carrier frequency of the transmitter, however, shall be same as \*4, and measurement shall be from just after starting the transmission until 50 pulse

\*4 The B.P.F. center frequency f<sub>0</sub> varies with model, as shown in Model Line-up

Burst wave

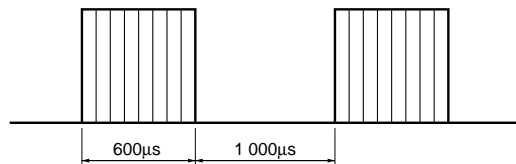

f<sub>0</sub>(\*4)  
Duty 50%

■ Performance

Using the transmitter shown in Fig. 1, the output signal of the light detecting unit is good enough to meet the following items in the standard optical system in Fig. 2.

1. Linear reception distance characteristics

When  $L=0.2$  to  $10.5(9.0)^{*7}$  m,  $^{*5}E_V < 10$  lx and  $\phi=0^\circ$  in Fig.2, the output signal shall meet the electrical characteristics in the attached list.

2. Sensitivity angle reception distance characteristics

When  $L=0.2$  to  $7.5(6.5)^{*7}$  m,  $^{*5}E_V < 10$  lx and  $\phi \leq 30^\circ$  in Fig.2, the output signal shall meet the electrical characteristics in the attached list.

3. Anti outer peripheral light reception distance characteristics

When  $L=0.2$  to  $5.0(4.0)^{*7}$  m,  $^{*6}E_V \leq 300$  lx and  $\phi=0^\circ$  in Fig.2, the output signal shall meet the electrical characteristics in the attached list.

\*5 It refers to detector face illuminance

\*6 Outer peripheral light source: CIE standard light source A shall be used and placed at  $45^\circ$  from perpendicular axis at the detector face center

\*7 In case of B.P.F. center frequency: 56.8kHz model

Fig.1 Transmitter

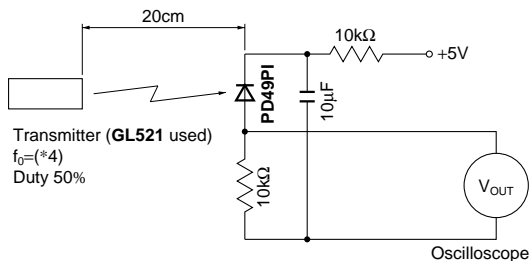

In the above figure, the transmitter should be set so that the output  $V_{OUT(P-P)}$  can be 40mV. However, the **PD49PI** to be used here should be of the short-circuit current  $I_{SC}=2.6\mu A$  at  $E_V = 100$  lx. ( $E_V$  is an illuminance by CIE standard light source A (tungsten lamp).)

Fig.2 Standard Optical System

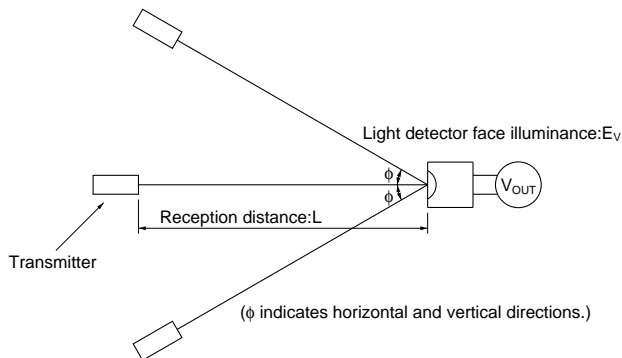

## ■ Precautions for Operation

- When this infrared remote control detecting unit shall be adopted for wireless remote control, please use it with the signal format of transmitter, which total duty ratio  $D_t$  (Emitting time  $\sum_{N=1}^n t_N$  / Transmitting time for 1 block  $T$ ) is 40% or less. ON signal time  $T_{ON}$  (Pulse width of the presence of modulated IR) should be 250(200:In case of B.P.F center frequency:56.8kHz model) $\mu$ s or more. In case that the signal format of total duty and ON signal time is out of above conditions, there is a case that reception distance is much reduced or output is not appeared.

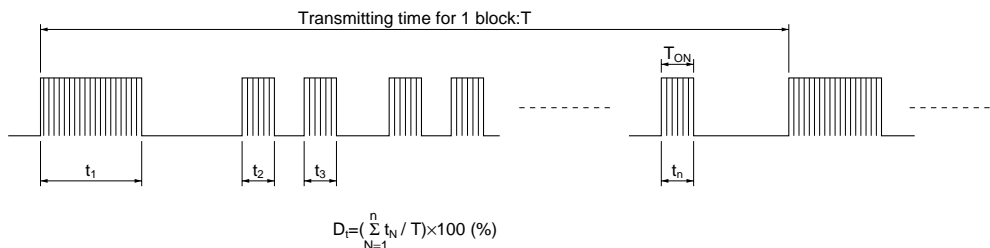

- Use the light emitting unit (remote control transmitter), in consideration of performance, characteristics, operating conditions of light emitting device and the characteristics of the light detecting unit.
- Pay attention to a malfunction of the light detecting unit when the surface is stained with dust and refuse. Care must be taken not to touch the light detector surface. If it should be dirty, wipe off such dust and refuse with soft cloth so as to prevent scratch. In case some solvents are required, use methyl alcohol, ethyl alcohol or isopropyl alcohol only. Also, protect the light detecting unit against flux and others, since their deposition on the unit inside causes reduction of the function, fading of markings such as the part number.
- The shield case should be grounded on PCB pattern. (The area across the shield case and the GND terminal is internally conductive in some cases and non-conductive in some other cases.)
- Do not apply unnecessary force to the terminal and the case.
- Do not push the light detector surface (photodiode) from outside.
- To avoid the electrostatic breakdown of IC, handle the unit under the condition of grounding with human body, soldering iron, etc.
- Do not use hole and groove set in the case of the light detecting unit for other purposes, since they are required to maintain the specified performance.
- External Circuit Examples (Mount the outer parts as near the unit as possible).

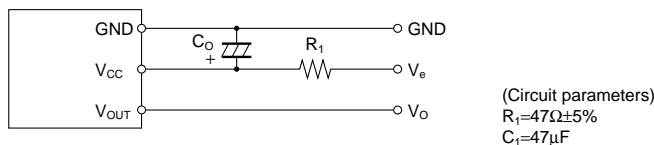

In setting  $R_1$  and  $C_1$ , use suitable values after considering under the real condition

The circuit constant is an example. It is different from mounting equipment. Please select it by your mounting equipment.

This device has a transistor as protection element between  $V_{CC}$  and GND to improve anti-static electricity proof.

Please be carefully not to apply exceeding the absolute maximum ratings of applying voltage and continuous high voltage spike noise because there is a case that transistor will be short by secondary breakdown generally. In order to do difficultly, Please add CR filter(47 $\Omega$ (1/10W), 10 $\mu$ F or more) such as external circuit example above near  $V_{CC}$ .

10. There is a possibility that noise on output may be caused by environmental condition (Disturbing light noise, Electromagnetic noise, Power supply line noise, etc.) even if there is no input transmission signal.
  11. Please shall confirm operation or your actual machine. Because the output pulse width of this product is fluctuated by environmental conditions such as signal format, temperature, distance from transmitter, and so on.
  12. In case that this product is kept in high humidity condition, it may be hard to solder, please be careful enough about storage method.  
Depend on the flux you select, there are different solderabilities, so please select a suitable flux and use it.
  13. Please use this device away from the dew drop.  
Be aware that the dew drop rusts shield case and others, may affect the electric characteristics.
-

## NOTICE

- The circuit application examples in this publication are provided to explain representative applications of SHARP devices and are not intended to guarantee any circuit design or license any intellectual property rights. SHARP takes no responsibility for any problems related to any intellectual property right of a third party resulting from the use of SHARP's devices.
- Contact SHARP in order to obtain the latest device specification sheets before using any SHARP device. SHARP reserves the right to make changes in the specifications, characteristics, data, materials, structure, and other contents described herein at any time without notice in order to improve design or reliability. Manufacturing locations are also subject to change without notice.
- Observe the following points when using any devices in this publication. SHARP takes no responsibility for damage caused by improper use of the devices which does not meet the conditions and absolute maximum ratings to be used specified in the relevant specification sheet nor meet the following conditions:
  - (i) The devices in this publication are designed for use in general electronic equipment designs such as:
    - Personal computers
    - Office automation equipment
    - Telecommunication equipment [terminal]
    - Test and measurement equipment
    - Industrial control
    - Audio visual equipment
    - Consumer electronics
  - (ii) Measures such as fail-safe function and redundant design should be taken to ensure reliability and safety when SHARP devices are used for or in connection with equipment that requires higher reliability such as:
    - Transportation control and safety equipment (i.e., aircraft, trains, automobiles, etc.)
    - Traffic signals
    - Gas leakage sensor breakers
    - Alarm equipment
    - Various safety devices, etc.
  - (iii) SHARP devices shall not be used for or in connection with equipment that requires an extremely high level of reliability and safety such as:
    - Space applications
    - Telecommunication equipment [trunk lines]
    - Nuclear power control equipment
    - Medical and other life support equipment (e.g., scuba).
- If the SHARP devices listed in this publication fall within the scope of strategic products described in the Foreign Exchange and Foreign Trade Law of Japan, it is necessary to obtain approval to export such SHARP devices.
- This publication is the proprietary product of SHARP and is copyrighted, with all rights reserved. Under the copyright laws, no part of this publication may be reproduced or transmitted in any form or by any means, electronic or mechanical, for any purpose, in whole or in part, without the express written permission of SHARP. Express written permission is also required before any use of this publication may be made by a third party.
- Contact and consult with a SHARP representative if there are any questions about the contents of this publication.