

Panasonic

NEW

Compact

Laser Displacement Sensor

New models

Measure distances as long as 250mm

Diffuse reflection type

Ideal for measuring mirrored objects

Specular reflection type

Diffuse reflection type HL-G125□

Specular reflection type HL-G10□A□

CE
Conforming to
EMC Directive

FDA
Conforming to
FDA regulations

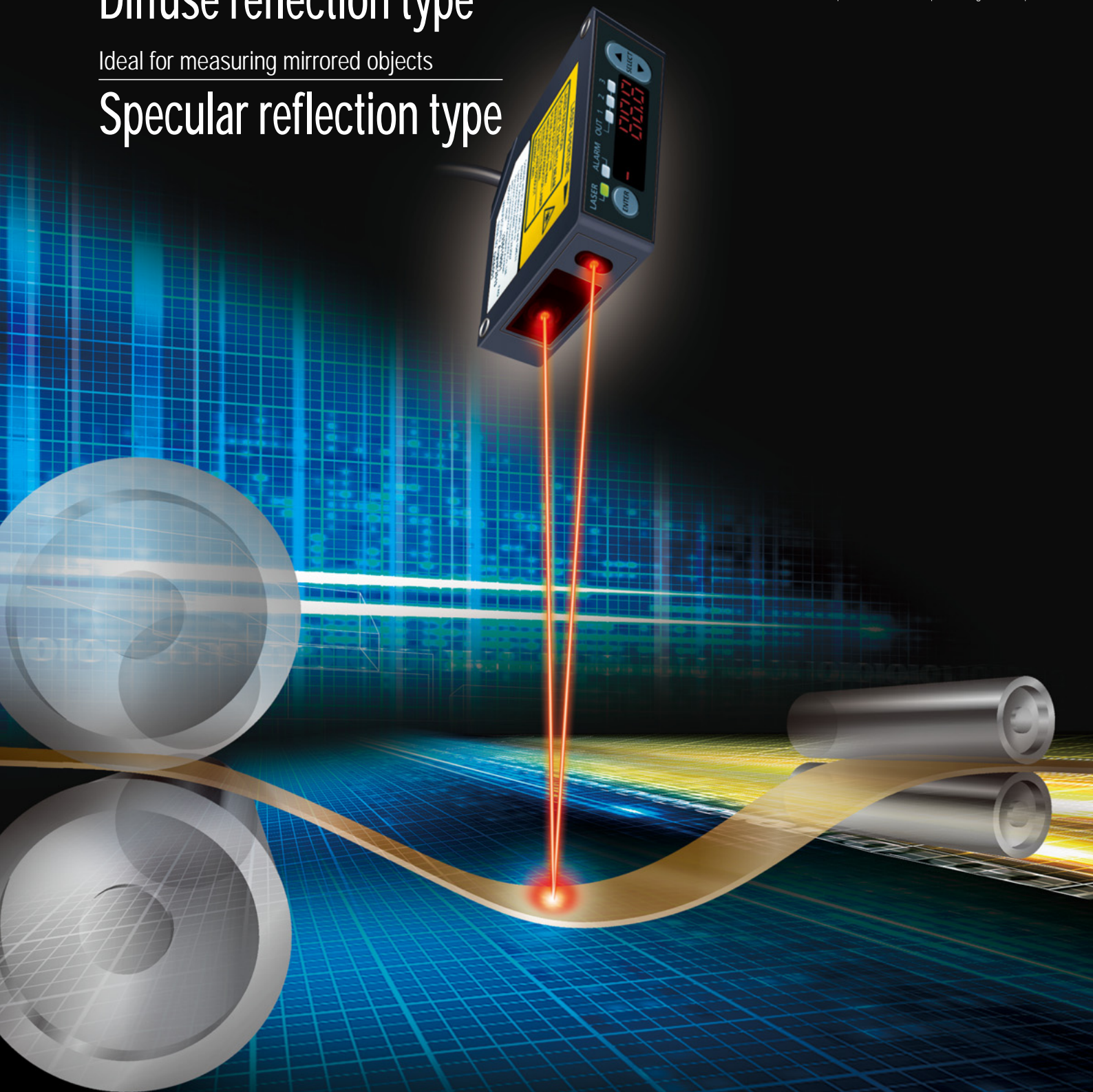

Extensive selection

A total of 8 models accommodate a variety of applications



Diffuse reflection type **HL-G103** □

Measurement range: $30 \pm 4 \text{ mm}$ $1.181 \pm 0.157 \text{ in}$
Resolution: $0.5 \mu\text{m}$ 0.020 mil
Linearity: $\pm 0.1 \%$ F.S.
Beam diameter: $0.1 \times 0.1 \text{ mm}$ $0.004 \times 0.004 \text{ in}$



Controlling the height of a dispenser nozzle

Specular reflection type **HL-G103A** □ **NEW**

Measurement range: $26.3 \pm 2 \text{ mm}$ $1.035 \pm 0.079 \text{ in}$
Resolution: $0.5 \mu\text{m}$ 0.020 mil
Linearity: $\pm 0.2 \%$ F.S.
Beam diameter: $0.1 \times 0.1 \text{ mm}$ $0.004 \times 0.004 \text{ in}$



Measuring HDD surface fluctuation

Diffuse reflection type **HL-G105** □

Measurement range: $50 \pm 10 \text{ mm}$ $1.969 \pm 0.394 \text{ in}$
Resolution: $1.5 \mu\text{m}$ 0.059 mil
Linearity: $\pm 0.1 \%$ F.S.
Beam diameter: $0.5 \times 1.0 \text{ mm}$ $0.020 \times 0.039 \text{ in}$



Inspecting processed food quantities

Specular reflection type **HL-G105A** □ **NEW**

Measurement range: $47.3 \pm 5 \text{ mm}$ $1.862 \pm 0.197 \text{ in}$
Resolution: $1.5 \mu\text{m}$ 0.059 mil
Linearity: $\pm 0.2 \%$ F.S.
Beam diameter: $0.1 \times 0.1 \text{ mm}$ $0.004 \times 0.004 \text{ in}$

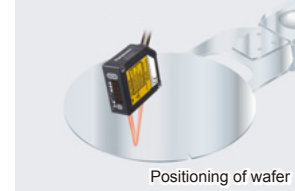

Positioning of wafer

Diffuse reflection type **HL-G108** □

Measurement range: $85 \pm 20 \text{ mm}$ $3.346 \pm 0.787 \text{ in}$
Resolution: $2.5 \mu\text{m}$ 0.098 mil
Linearity: $\pm 0.1 \%$ F.S.
Beam diameter: $0.75 \times 1.25 \text{ mm}$ $0.030 \times 0.049 \text{ in}$

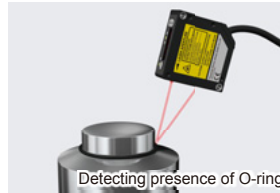

Detecting presence of O-ring

Specular reflection type **HL-G108A** □ **NEW**

Measurement range: $82.9 \pm 10 \text{ mm}$ $3.264 \pm 0.394 \text{ in}$
Resolution: $2.5 \mu\text{m}$ 0.098 mil
Linearity: $\pm 0.2 \%$ F.S.
Beam diameter: $0.2 \times 0.2 \text{ mm}$ $0.008 \times 0.008 \text{ in}$



Measuring the eccentricity of a metal shaft

Diffuse reflection type **HL-G112** □

Measurement range: $120 \pm 60 \text{ mm}$ $4.724 \pm 2.362 \text{ in}$
Resolution: $8 \mu\text{m}$ 0.315 mil
Linearity: $\pm 0.1 \%$ F.S.
Beam diameter: $1.0 \times 1.5 \text{ mm}$ $0.039 \times 0.059 \text{ in}$

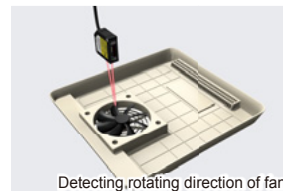

Detecting rotating direction of fan

Diffuse reflection type **HL-G125** □ **NEW**

Measurement range: $250 \pm 150 \text{ mm}$ $9.843 \pm 5.906 \text{ in}$
Resolution: $20 \mu\text{m}$ 0.787 mil
Linearity: $\pm 0.3 \%$ F.S.
Beam diameter: $1.75 \times 3.5 \text{ mm}$ $0.069 \times 0.138 \text{ in}$

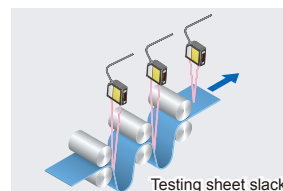

Testing sheet slack

SPECIFICATIONS

For more information about I/O circuit diagrams and communication specifications of the high-function type, refer to the **HL-G1** catalog or our website.

| Item | Model No. | Type | Diffuse reflection type | | | | | Specular reflection type | | |
|--|-------------------------|--------------------|--|----------------------------------|------------------------------------|----------------------------------|--|----------------------------------|---------------------|----------------------------------|
| | | Standard type | HL-G103-A-C5 | HL-G105-A-C5 | HL-G108-A-C5 | HL-G112-A-C5 | HL-G125-A-C5 | HL-G103A-RA-C5 | HL-G105A-RA-C5 | HL-G108A-RA-C5 |
| | | High function type | HL-G103-S-J | HL-G105-S-J | HL-G108-S-J | HL-G112-S-J | HL-G125-S-J | HL-G103A-RS-J | HL-G105A-RS-J | HL-G108A-RS-J |
| Measurement center distance | | | 30 mm 1.181 in | 50 mm 1.969 in | 85 mm 3.346 in | 120 mm 4.724 in | 250 mm 9.843 in | 26.3 mm 1.035 in | 47.3 mm 1.862 in | 82.9 mm 3.264 in |
| Measuring range | | | ±4 mm ±0.157 in | ±10 mm ±0.394 in | ±20 mm ±0.787 in | ±60 mm ±2.362 in | ±150 mm ±5.906 in | ±2 mm ±0.079 in | ±5 mm ±0.197 in | ±10 mm ±0.394 in |
| Resolution | | | 0.5 μm 0.020 mil | 1.5 μm 0.059 mil | 2.5 μm 0.098 mil | 8 μm 0.315 mil | 20 μm 0.787 mil | 0.5 μm 0.020 mil | 1.5 μm 0.059 mil | 2.5 μm 0.098 mil |
| Linearity | | | ±0.1 % F.S. | | | | ±0.3 % F.S. | ±0.2 % F.S. | | |
| Temperature characteristics | | | ±0.08 % F.S. / °C | | | | | | | |
| Light source | | | Red semiconductor laser, Class 2 (Class 1 for specular reflection type) (IEC / JIS / FDA, Laser Notice No. 50) Max. output: 1 mW (0.39mW for specular reflection type) Peak emission wavelength: 655 nm 0.026 mil | | | | | | | |
| Beam diameter (Note 2) | | | 0.1 × 0.1 mm 0.004 × 0.004 in | 0.5 × 1.0 mm 0.020 × 0.039 in | 0.75 × 1.25 mm 0.030 × 0.049 in | 1.0 × 1.5 mm 0.039 × 0.059 in | 1.75 × 3.5 mm 0.069 × 0.138 in | 0.1 × 0.1 mm 0.004 × 0.004 in | | 0.2 × 0.2 mm 0.008 × 0.008 in |
| Receiving element | | | CMOS image sensor | | | | | | | |
| Supply voltage | | | 24 V DC ±10 % including ripple 0.5 V (P-P) | | | | | | | |
| Current consumption | | | 100 mA max. | | | | | | | |
| Sampling rate | | | 200 μs, 500 μs, 1 ms, 2 ms | | | | | | | |
| Analog output | Voltage | | Output range: 0 to 10.5 V (normal) / 11 V (at alarm), Output impedance: 100 Ω | | | | | | | |
| | Current | | Output range: 3.2 to 20.8 mA (normal) / 21.6 mA (at alarm), Load impedance: 300 Ω max. | | | | | | | |
| Output (OUT 1, OUT 2, OUT 3) | | | Judgment output or alarm output (setting selectable) NPN transistor, open-collector / PNP transistor, open-collector (selectable) | | | | | | | |
| | | | <In case of using NPN output> • Maximum sink current : 50 mA • Applied voltage : 3 to 24 V DC (between output and 0 V) • Residual voltage : 2 V or less (at 50 mA of sink current) | | | | <In case of using PNP output> • Maximum source current : 50 mA • Residual voltage : 2.8 V or less (at 50 mA of source current) | | | |
| | Output operation | | Open when the output is ON. | | | | | | | |
| Short circuit protection | | | Incorporated (automatic restoration) | | | | | | | |
| Output polarity setting input | | | NPN open collector output operates when 0 V is connected. PNP open collector output operates when 24 V DC is connected. | | | | | | | |
| Timing input | | | NPN output operates when 0 V is connected and NPN is set (depending on settings). PNP output operates when external power + is connected and PNP is set (depending on settings). | | | | | | | |
| Multi input | | | Zero set, zero set off, reset, memory switching, teaching, saving, and laser control according to the input time. In case NPN output is selected, function varies according to the time 0 V is connected NPN. In case PNP output is selected, function varies according to the time external power + is connected. | | | | | | | |
| Communications interface (high-function type only) | | | RS-422 or RS-485 (selectable) Baud rate: 9,600 / 19,200 / 38,400 / 115,200 / 230,400 / 460,800 / 921,600 bps Data length 8 bit, stop bit length 1 bit, without parity check, BCC check, termination code: CR | | | | | | | |
| Indicator | Laser emission | | Green LED (lights up during laser emission) | | | | | | | |
| | Alarm | | Orange LED (lights up when this product cannot measure because of insufficient or excessive light intensity) | | | | | | | |
| | Output | | Yellow LED x 3 | | | | | | | |
| Digital display | | | Red LED 5.5 digit display | | | | | | | |
| Protection | | | IP67 (IEC) | | | | | | | |
| Ambient temperature | | | -10 to +45 °C +14 to +113 °F (No dew condensation), Storage: -20 to +60 °C -4 to +140 °F (No dew condensation) | | | | | | | |
| Material | | | Enclosure: PBT, front cover: acrylic, cable: PVC | | | | | | | |
| Cable | | | Standard type: 0.1 mm ² 10-core cabtyre cable, 5 m 16.404 ft long, high functionality type: 14-core cabtyre cable with connector, 0.5 m 1.640 ft long | | | | | | | |
| Cable extension | | | Extension up to total 20 m 65.617 ft is possible with optional cable (Cable for standard type cannot be extended). | | | | | | | |
| Weight | Standard type | | Net weight: 70 g approx. (not including cable), 320 g approx. (including cable), gross weight: 380 g approx. | | | | | | | |
| | High functionality type | | Net weight: 70 g approx. (not including cable), 110 g approx. (including cable), gross weight: 160 g approx. | | | | | | | |
| Accessory | | | Warning label: 1 set | | | | | | | |

Notes: 1) Where measurement conditions have not been specified precisely, the conditions used were as follows: supply voltage 24 V DC, ambient temperature +20 °C +68 °F, sampling rate 500 μs, average number of samples: 1024, measurement center distance, object measured is made of white ceramic and analog measurement values.

2) This beam diameter is the size at the measurement center distance. These values were defined by using 1/e² (13.5 %) of the center light intensity. The results may be affected if there is a slight leakage of light outside the normal spot diameter and if the periphery surrounding the sensing point has a higher reflectivity than the sensing point itself.

OPTIONS

| Type | Appearance | Model No. | Description |
|--|---|------------|---|
| Extension cable (for High function type) |  | HL-G1CCJ2 | Length: 2 m 6.562 ft, Weight: 130 g approx. |
| | | HL-G1CCJ5 | Length: 5 m 16.404 ft, Weight: 320 g approx. |
| | | HL-G1CCJ10 | Length: 10 m 32.808 ft, Weight: 630 g approx. |
| | | HL-G1CCJ20 | Length: 20 m 65.617 ft, Weight: 1300 g approx. |
| | | | 14-core cabtyre cable with connector on both ends |

SENSING CHARACTERISTICS (TYPICAL)

For sensing characteristics diagrams for the diffuse reflection type (other than the HL-G125□), refer to the HL-G1 catalog or our website.

Correlation between measuring distance and error characteristics

White ceramic
Vertical orientation

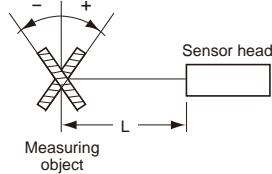

White ceramic
Horizontal orientation

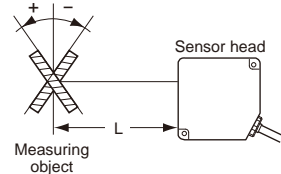

HL-G125□

Diffuse reflection type

HL-G103A-R□

Specular reflection type

Vertical positioning

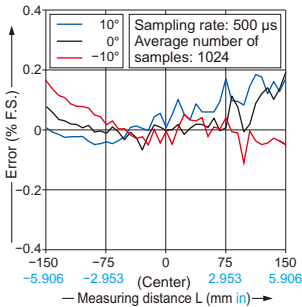

Horizontal positioning

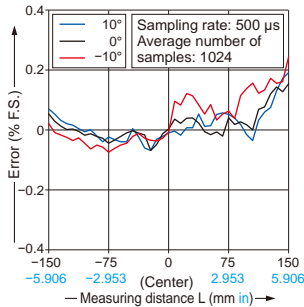

Vertical positioning

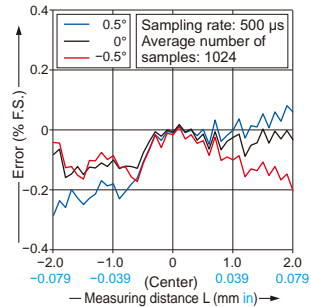

Horizontal positioning

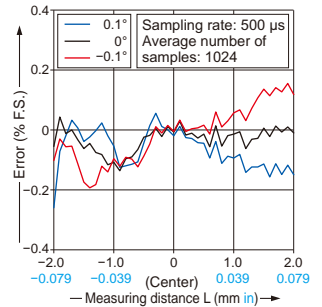

HL-G105A-R□

Specular reflection type

HL-G108A-R□

Specular reflection type

Vertical positioning

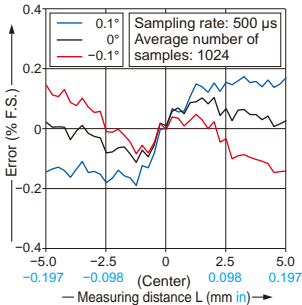

Horizontal positioning

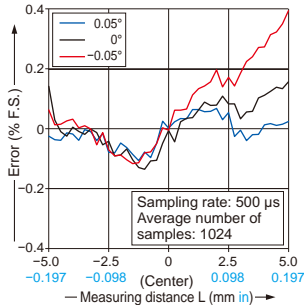

Vertical positioning

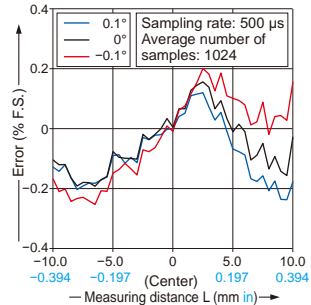

Horizontal positioning

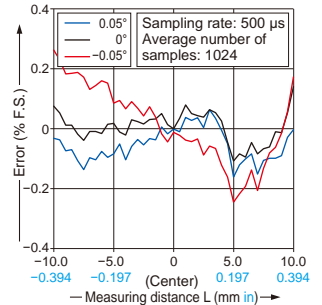

PRECAUTIONS FOR PROPER USE



- This product has been developed / produced for industrial use.
- Never use this product as a sensing device for personnel protection.
- In case of using sensing devices for personnel protection, use products which meet laws and standards, such as OSHA, ANSI or IEC etc., for personnel protection applicable in each region or country.



- Do not operate products using methods other than the ones described in the instruction manual included with each product. Control or adjustment through procedures other than the ones specified may cause hazardous laser radiation exposure.
- The following label is attached to the product. Handle the product according to the instruction given on the warning label.
(The Japanese, English, Chinese, Korean warning label is packed with the sensor.)

- This product is classified as a Class 2 (specular reflection type: Class 1) Laser Product under IEC / JIS standards and FDA regulations. Do not look at the laser beam directly or through an optical system such as a lens.



(A Class 2 label is shown above.)

A variety of high-end functions are included in a compact, self-contained body for exceptional ease of use

Easy input settings while looking at digital display

The built-in digital display makes it easy to perform sensor setting while checking displacement values.

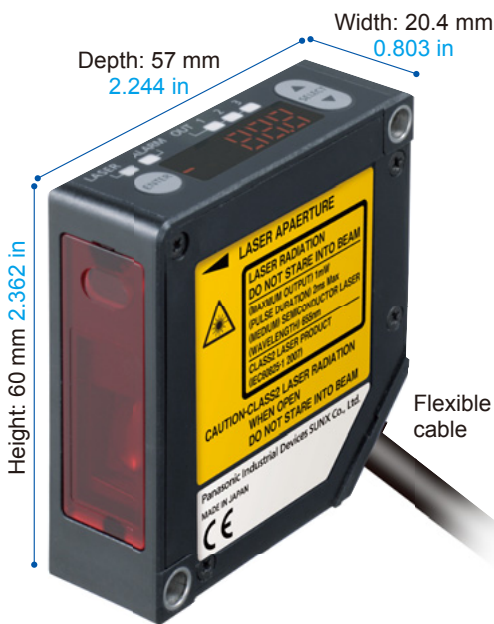
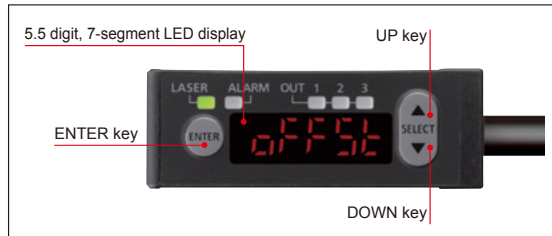

Easy to embed in machines and production lines thanks to a built-in controller

Controller installation and mounting space is not required because controller function is included in sensor unit.

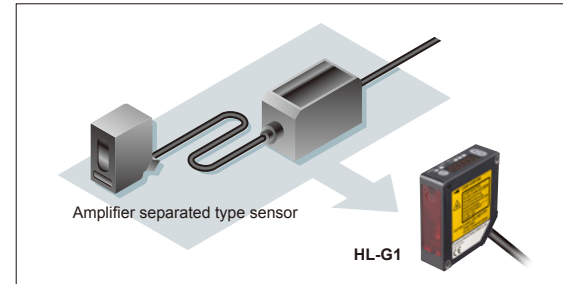

Lightweight body that can be installed on movable parts

Its lightweight resin body weighs 70 g approx., which can be installed on moving parts such as sliders and robot arms. Cable with superior flexibility is fitted as standard.

IP67 protective enclosure protects from water and dust

Thanks to its IP67 protective enclosure, the HL-G1 can be used in the presence of water and dust. Mounting holes are lined with metal sleeves, allowing the instrument to be tightened securely in place with up to 0.8 N·m of torque.



Software tool for sensor configuration and evaluation

In addition to configuring up to 16 sensors at once, this free tool makes it easy to gather data needed for analysis, such as received light waveform monitoring and data buffering. The interface language can be selected at the time of installation.

- **Data buffering**
Stores and displays measurement data, which can be superimposed on previously recorded data for easy comparison and analysis.
- **Received light waveform display**
Displays the amount of light received by cell from light-receiving element.
- **Measured value display**
Displays measured values as well as the output state for each terminal.

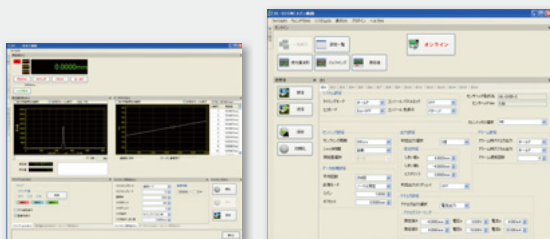

HMI screen data for sensor setting and data indication

The GT02 / GT12 series HMI can be used in combination with the HL-G1 to allow easy confirmation of sensor status and configuration of sensor settings from a remote location. Japanese, English, Chinese, and Korean are supported. For more information about the GT series, visit our website or refer to our catalog.

Select from the following HMI operator panels:

Power supply: 24 V
Communication port: RS422 (RS485)

- AIG02GQ14D
- AIG02MQ15D
- AIG12GQ14D / AIG12GQ15D
- AIG12MQ14D / AIG12MQ15D



Software is available for download.

Sensor configuration and evaluation software tool, HMI screen data, function blocks, etc.

Terms of use

Panasonic Industrial Devices SUNX offers no warranty for this software and is not liable for any loss or damage suffered as a result of its use or operation, whether direct, indirect, incidental, consequential, or unforeseen.

DIMENSIONS (Unit: mm in)

For dimensions of the diffuse reflection type (other than the HL-G125□), refer to the HL-G1 catalog or our website. CAD data for dimensional diagrams can be downloaded from our website.

HL-G125-A-C5 HL-G125-S-J

Sensor head

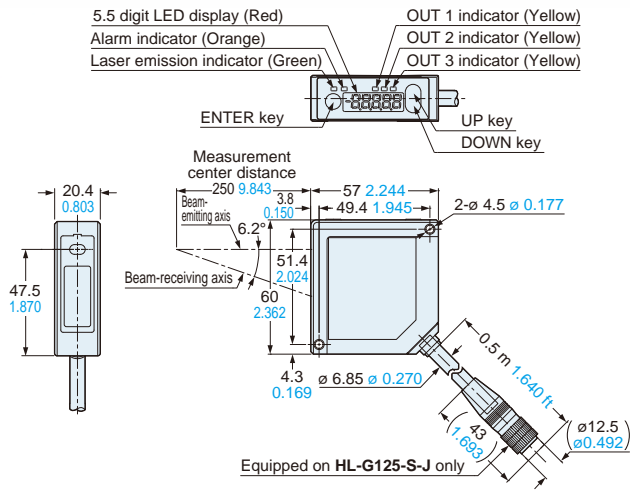

HL-G103A-RA-C5 HL-G103A-RS-J

Sensor head

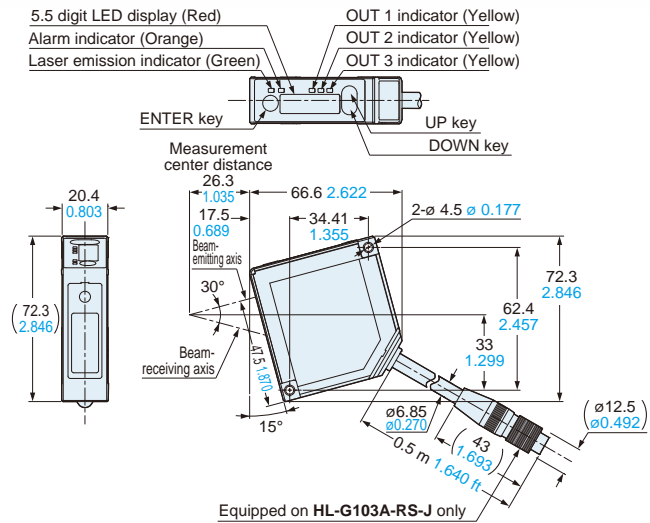

HL-G105A-RA-C5 HL-G105A-RS-J

Sensor head

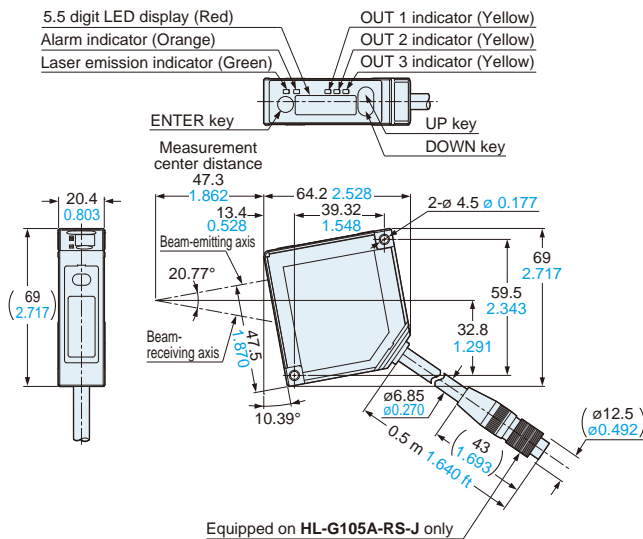

HL-G108A-RA-C5 HL-G108A-RS-J

Sensor head

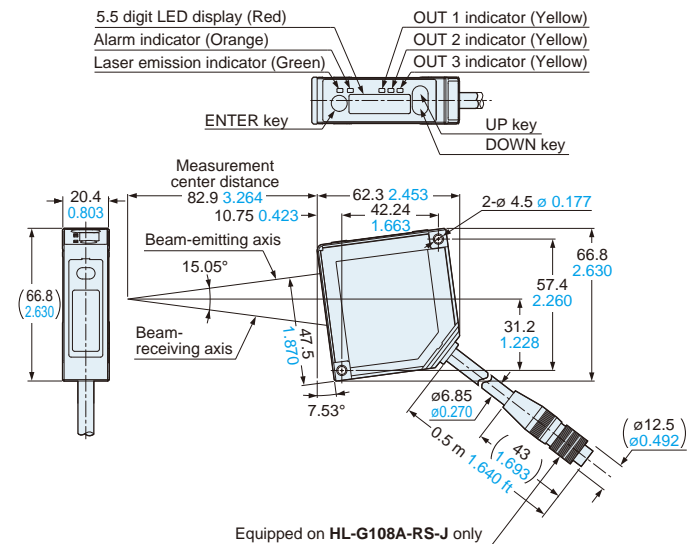

HL-G1CCJ□

Extension cable (optional)

Extension cable

| Model No. | L |
|------------|--|
| HL-G1CCJ2 | 2,000 ⁺²⁰⁰ ₀ 78.740 ^{+7.874} ₀ |
| HL-G1CCJ5 | 5,000 ⁺⁵⁰⁰ ₀ 196.850 ^{+19.685} ₀ |
| HL-G1CCJ10 | 10,000 ^{+1,000} ₀ 393.701 ^{+39.370} ₀ |
| HL-G1CCJ20 | 20,000 ^{+2,000} ₀ 787.402 ^{+78.740} ₀ |

