

Evaluating the **AD5535B**, 32-Channel, 14-Bit, High Voltage Output DAC

FEATURES

- Full featured evaluation board for the **AD5535B**
- On-board reference
- PC control in conjunction with the **EVAL-SDP-CS1Z** system demonstration platform
- PC software for voltage output control

EVALUATION KIT CONTENTS

- EVAL-AD5535BSDZ** evaluation board
- Evaluation software CD for the **AD5535B**

ADDITIONAL EQUIPMENT NEEDED

- EVAL-SDP-CS1Z** system demonstration platform, includes a USB cable
- Power supply with 5 V output
- DC voltage calibrator or 60 V power supply
- PC running Windows XP SP2, Windows Vista, or Windows 7 with USB 2.0 port

ONLINE RESOURCES

Documents

- [AD5535B data sheet](#)
- [EVAL-AD5535BSDZ user guide](#)

Required Software

- [EVAL-AD5535BSDZ evaluation software](#)

GENERAL DESCRIPTION

The **EVAL-AD5535BSDZ** is a full featured evaluation board that can be used to easily evaluate all the features of the **AD5535B**. The **AD5535B** is a 32-channel, 14-bit, high voltage output *denseDAC*® with an on-chip high voltage output amplifier.

The **AD5535B** output voltage range is programmable via the REF_IN pin. The output range is 0 V to 50 V when REF_IN = 1 V, and 0 V to 200 V when REF_IN = 4 V. Each amplifier can source 550 μ A. REF_IN is buffered internally on the **AD5535B** and must be driven from a stable reference source.

The selected digital-to-analog converter (DAC) register is written to via the 3-wire interface. The serial interface operates at clock rates of up to 30 MHz and is compatible with DSP and microcontroller interface standards.

The **EVAL-SDP-CS1Z** board allows the **EVAL-AD5535BSDZ** evaluation board to be controlled via the USB port of a PC using the **AD5535B** evaluation board software.

The **EVAL-AD5535BSDZ** requires 60 V and 5 V external power supplies. The **EVAL-AD5535BSDZ** evaluation board provides power to the **EVAL-SDP-CS1Z** controller board. On-board components include the REF198, 4.096 V, precision micropower, low dropout, low voltage reference.

FUNCTIONAL BLOCK DIAGRAM

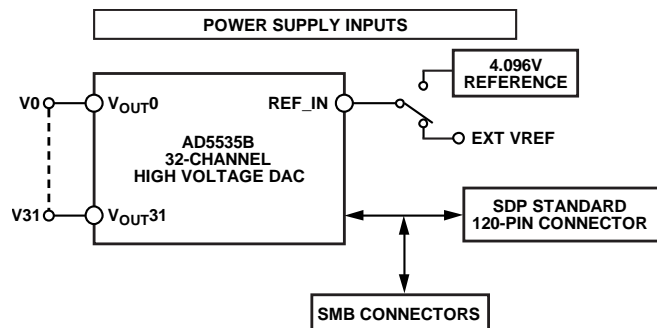

Figure 1.

12480-001

TABLE OF CONTENTS

Features	1	Software Installation Procedures.....	4
Evaluation Kit Contents.....	1	Evaluation Board Setup Procedures	6
Additional Equipment Needed.....	1	Evaluation Board Hardware.....	7
Online Resources.....	1	Link Configuration Options.....	7
General Description	1	Power Supplies.....	7
Functional Block Diagram	1	How to Use the Software for Evaluating the AD5535B.....	8
Revision History	2	Setting Up the System.....	8
Getting Started	3	Overview of the Main Window.....	9
Quick Start Steps	3	Related Links.....	10

REVISION HISTORY

9/14—Revision 0: Initial Version

GETTING STARTED

QUICK START STEPS

To begin using the evaluation board, take the following steps:

1. With the [EVAL-SDP-CS1Z](#) board disconnected from the USB port of the PC, install the [AD5535B](#) evaluation board software from the CD included in the evaluation board kit. The PC must be restarted after the software installation is complete. (For complete software installation instructions, see the Software Installation Procedures section.)
2. Connect the [EVAL-SDP-CS1Z](#) board to the [EVAL-AD5535BSDZ](#) evaluation board as shown in Figure 2. Screw the two boards together using the nylon screw/nut set included in the evaluation board kit to ensure that the boards are connected firmly together.
3. Connect the 60 V power supply to V_{PP} and connect the 5 V supply to AV_{CC} , DV_{CC} , and V_{+} (5 V).
4. Connect the [EVAL-SDP-CS1Z](#) board to the PC using the supplied USB cable. If you are using Windows® XP, you may need to search for the [EVAL-SDP-CS1Z](#) drivers. Choose to automatically search for the drivers for the [EVAL-SDP-CS1Z](#) board if prompted by the operating system.
5. Launch the [AD5535B](#) evaluation board software from the **Analog Devices** subfolder in the **Programs** menu.

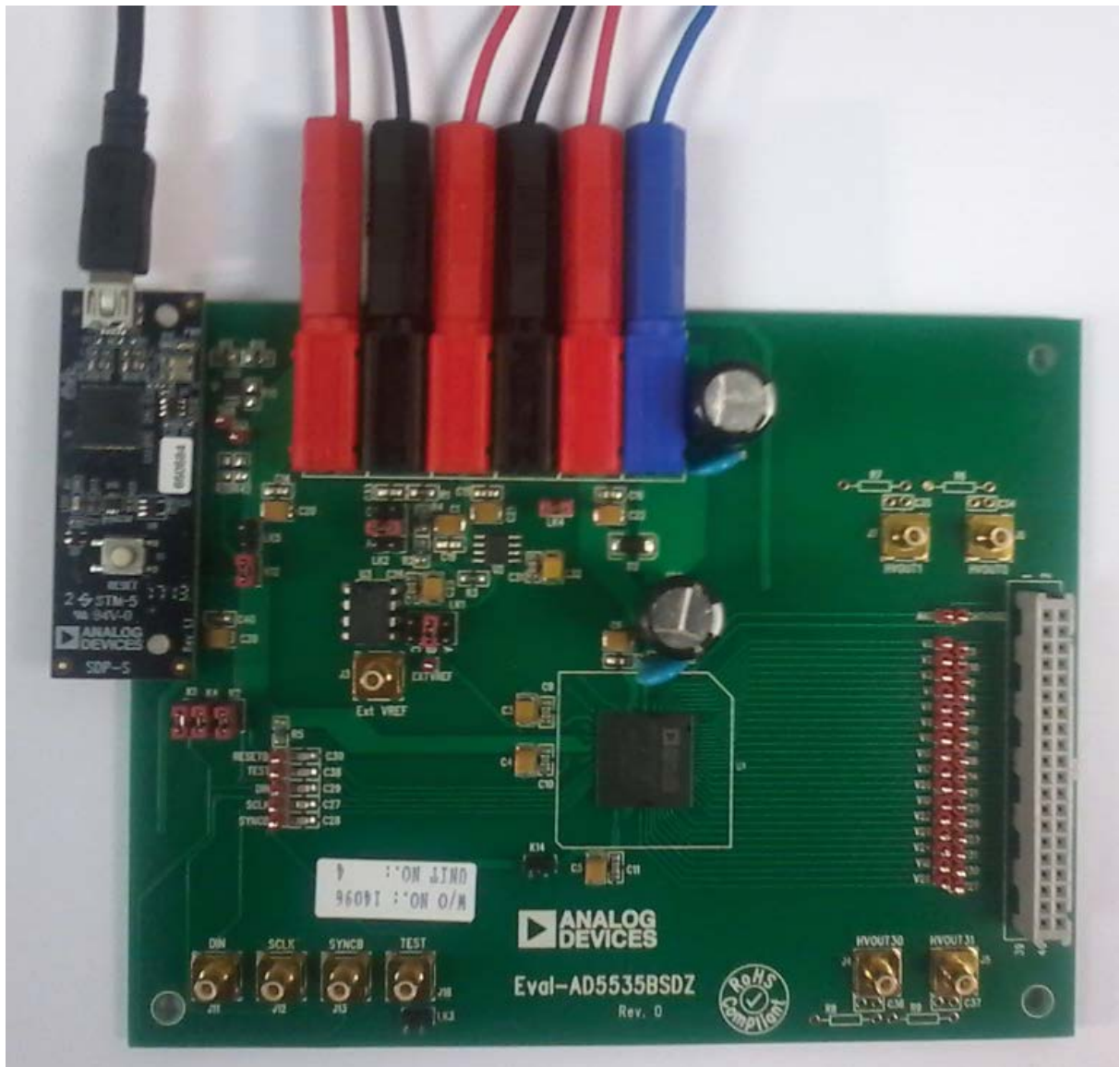

Figure 2. Hardware Configuration—Photo of the [EVAL-AD5535BSDZ](#) Board Connected to [SDP-S](#) and Powered

SOFTWARE INSTALLATION PROCEDURES

The EVAL-AD5535BSDZ evaluation kit includes a CD containing software to be installed on the PC before using the evaluation board.

There are two parts to the installation:

- AD5535B evaluation board software installation
- EVAL-SDP-CS1Z system demonstration platform board drivers installation

Warning

The evaluation board software and drivers must be installed before connecting the evaluation board and the EVAL-SDP-CS1Z board to the USB port of the PC to ensure that the evaluation system is correctly recognized when it is connected to the PC.

Installing the AD5535B Evaluation Board Software

Take the following steps to install the AD5535B evaluation board software:

1. With the EVAL-SDP-CS1Z board disconnected from the USB port of the PC, insert the installation CD into the CD-ROM drive.
2. Double-click the **setup.exe** file to begin the evaluation board software installation. The software is installed to the following default location: **C:\Program Files (x86)\AD5535B**.
3. A dialog box appears requesting permission to allow the program to make changes to your computer. Click **Yes**.



Figure 3. AD5535B Evaluation Board Software Installation: Granting Permission for Program to Make Changes

4. Select the location to install the software, and then click **Next**.

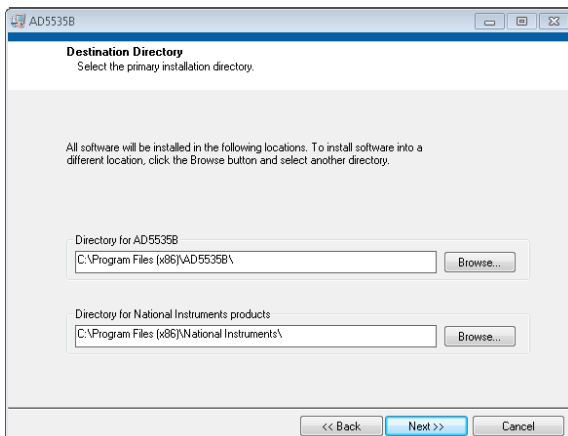

Figure 4. AD5535B Evaluation Board Software Installation: Selecting the Location for Software Installation

5. A license agreement appears. Read the agreement, and then select **I accept the License Agreement** and click **Next**.

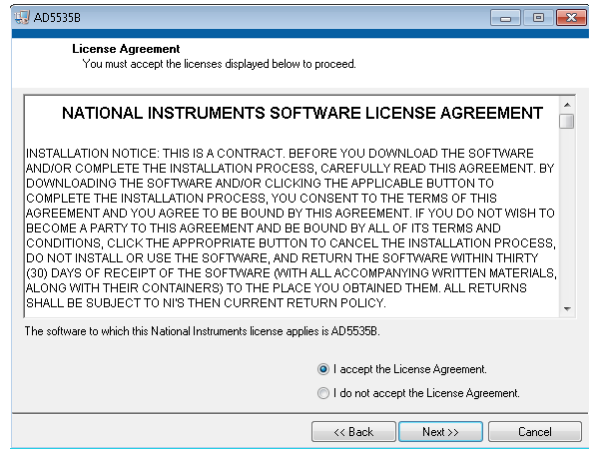

Figure 5. AD5535B Evaluation Board Software Installation: Accepting the License Agreement

6. A summary of the installation is displayed. Click **Next** to continue.

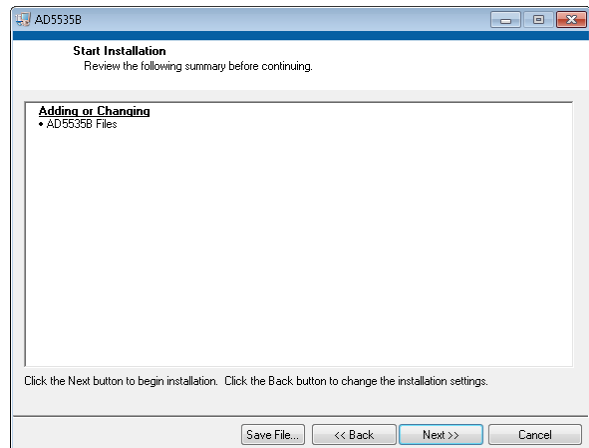

Figure 6. AD5535B Evaluation Board Software Installation: Reviewing a Summary of the Installation

7. The message in Figure 7 appears when the installation is complete. Click **Next**.

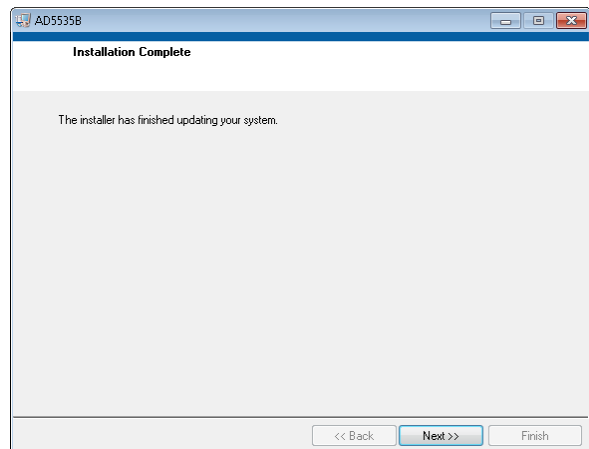

Figure 7. AD5535B Evaluation Board Software Installation: Indicating When the Installation Is Complete

Installing the EVAL-SDP-CS1Z System Demonstration Platform Board Drivers

After the installation of the evaluation board software is complete, the ADI SDP Drivers Setup Wizard opens for the installation of the EVAL-SDP-CS1Z system demonstration platform board drivers.

1. With the EVAL-SDP-CS1Z board still disconnected from the USB port of the PC, make sure that all other applications are closed, and then click **Next**.



Figure 8. EVAL-SDP-CS1Z Drivers Setup: Beginning the Drivers Installation

2. Select the location to install the drivers, and then click **Next**.

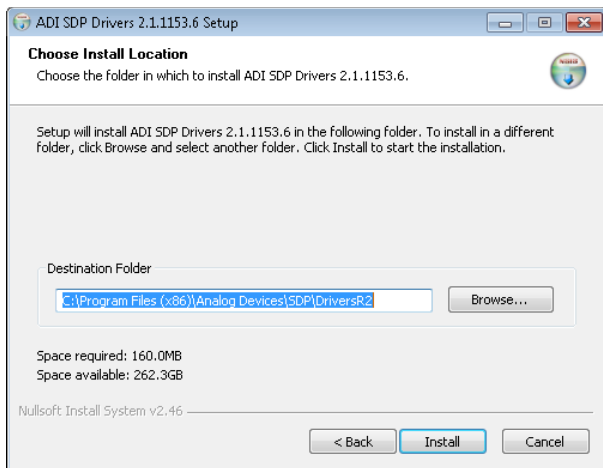

Figure 9. EVAL-SDP-CS1Z Drivers Setup: Selecting the Location for Drivers Installation

3. Click **Install** to install the drivers.

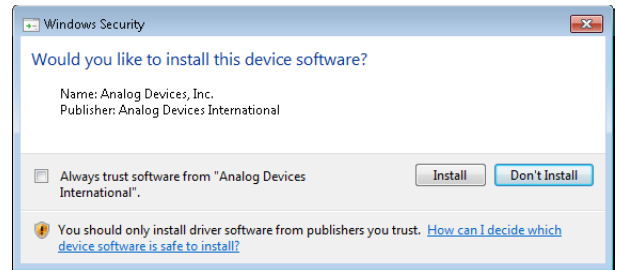

Figure 10. EVAL-SDP-CB1Z Drivers Setup: Granting Permission to Install Drivers

4. To complete the drivers installation, click **Close**, which closes the setup wizard.

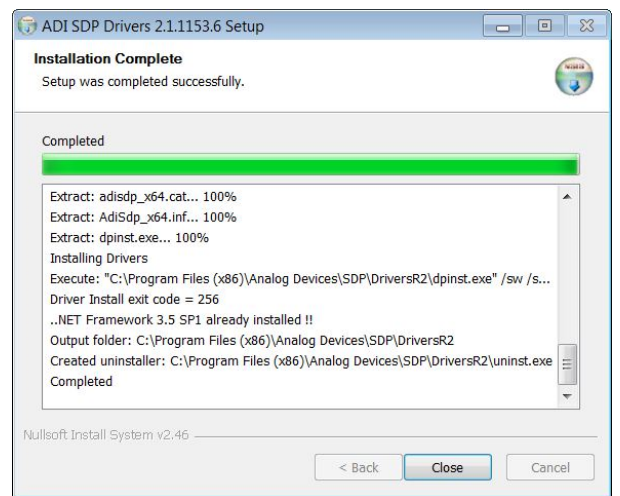

Figure 11. EVAL-SDP-CB1Z Drivers Setup: Completing the Drivers Installation

5. Before using the evaluation board, you must restart your computer. A dialog box opens with the following options: **Restart**, **Shut Down**, and **Restart Later**. Click the appropriate button.

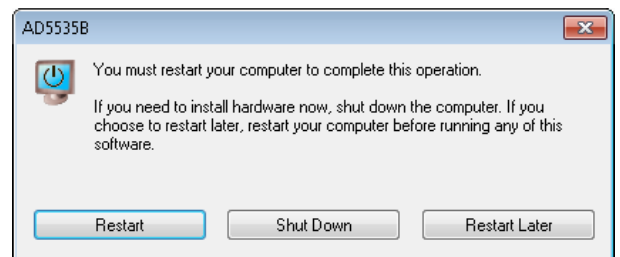

Figure 12. EVAL-SDP-CS1Z Drivers Setup: Restarting the Computer

EVALUATION BOARD SETUP PROCEDURES

The EVAL-AD5535BSDZ evaluation board connects to the EVAL-SDP-CS1Z system demonstration board. The EVAL-SDP-CS1Z board is the controller board, which is the communication link between the PC and the EVAL-AD5535BSDZ evaluation board. Figure 2 shows a photograph of the connections made between the EVAL-AD5535BSDZ daughter board and the EVAL-SDP-CS1Z board.

After following the instructions in the Software Installation Procedures section, set up the evaluation board and the SDP board as detailed in this section.

Warning

The evaluation software and drivers must be installed before connecting the evaluation board and EVAL-SDP-CS1Z board to the USB port of the PC to ensure that the evaluation system is correctly recognized when it is connected to the PC.

Configuring the Evaluation and SDP Boards

1. Connect the EVAL-AD5535BSDZ evaluation board to Connector A of the EVAL-SDP-CS1Z board (see Figure 2).
 - a. Screw the two boards together using the nylon screw/nut set included in the evaluation board kit to ensure that the boards are connected firmly together.
2. Connect the external power supplies as shown in Table 3
3. Connect the EVAL-SDP-CS1Z board to the PC using the supplied USB cable.

EVALUATION BOARD HARDWARE

LINK CONFIGURATION OPTIONS

There are multiple jumper (LKx and Kx) options that must be set correctly to select the appropriate operating setup before using the evaluation board. The functions of these options are shown in Table 1.

Setup Conditions

Before applying power and signals to the evaluation board, ensure that all link positions are as required by the operating

mode. There are two modes in which to operate the evaluation board. The evaluation board can be operated in SDP controlled mode to be used with the SDP board, or the evaluation board can be used in standalone mode.

Table 2 shows the default positions in which the links are set when the evaluation board is packaged. When the board is shipped, it is assumed the evaluation board is to be operated with the SDP board in SDP controlled mode.

Table 1. Link Option Functions

Link No.	Function
LK1	Reference selection Position A: external reference (via J3) Position B: 4.096 V reference Position C: scaled reference selection (see LK2 for selection)
LK2	Scaled reference selection Position A: 3.072 V reference Position B: 2.048 V reference Position C: 1.024 V reference
LK3	TEST input pin set inactive
LK4	AV _{CC} to V ₊ connection
LK5	DV _{CC} to 3.3 V connection
K1	SYNCB to J19 connector
K2	DIN to J19 connector
K4	SCLK to J19 connector
K12	3.3 V to VIO (3.3 V) on J19 connector
K14	AV _{CC} to VIN on J19 connector

Table 2. Default Link Positions for Packaged EVAL-AD5535BSDZ

Link No.	Position	Function
LK1	Position B	4.096 V on-board reference is selected
LK2	Position B	Selection of scaled reference option
LK3	Not inserted	TEST pin control
LK4	Inserted	AV _{CC} to V ₊
LK5	Not inserted	DV _{CC} to 3.3 V
K1	Inserted	SYNCB to J19 connector
K2	Inserted	DIN to J19 connector
K4	Inserted	SCLK to J19 connector
K12	Inserted	3.3 V to VIO (3.3 V) on J19 connector
K14	Not inserted	AV _{CC} to VIN on J19 connector

POWER SUPPLIES

Table 3. External Power Supplies Required

Power Supply	Connector	Voltage Range	Purpose
DV _{CC} (5 V)	J15	2.7 V to 5.25 V	Supplies the DV _{CC} digital supply
AV _{CC} (5 V)	J14	4.75 V to 5.25 V	Supplies the AV _{CC} analog supply
V ₊ (5 V)	J9	4.75 V to 5.25 V	Supplies the V ₊ (5 V) supply
V _{PP} (210 V)	J8	60 V to 225 V	Supplies the V _{PP} high voltage part supply

HOW TO USE THE SOFTWARE FOR EVALUATING THE AD5535B

SETTING UP THE SYSTEM

After completing the steps in the Software Installation Procedures section and the Evaluation Board Setup Procedures section, set up the system for data capture as follows:

1. Allow the **Found New Hardware Wizard** to run after the **EVAL-SDP-CS1Z** board is plugged into your PC. (If you are using Windows XP, you may need to search for the **EVAL-SDP-CS1Z** drivers. Choose to automatically search for the drivers for the **EVAL-SDP-CS1Z** board if prompted by the operating system.)
2. Check that the board is connected to the PC correctly using the **Device Manager** of the PC.
 - a. Access the **Device Manager** by right-clicking **My Computer** and then clicking **Manage**.
 - b. A dialog box appears requesting permission to allow the program to make changes to your computer. Click **Yes**.
 - c. The **Computer Management** box appears. Click **Device Manager** from the list of **System Tools** (see Figure 13).
 - d. Under **ADI Development Tools**, **Analog Devices System Development Platform SDP-S** appears, which indicates that the **EVAL-SDP-CS1Z** driver software is installed and that the board is connected to the PC correctly.

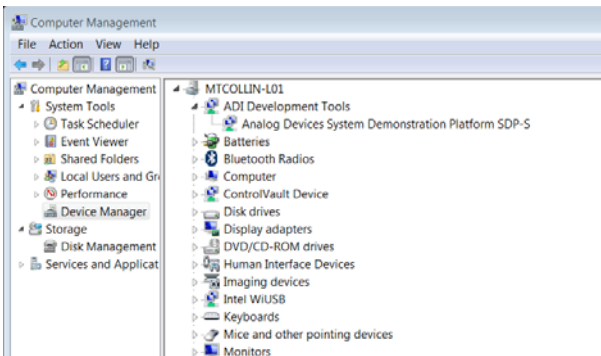

Figure 13. Device Manager: Checking that the Board Is Connected to the PC Correctly

Launching the Software

After completing the steps in the Setting Up the System section, launch the **AD5535B** evaluation board software as follows:

1. From the **Start** menu, go to **Programs > Analog Devices > AD5535B**. The main window of the **AD5535B** evaluation board software opens.
2. If the **EVAL-AD5535BSDZ** evaluation system is not connected to the USB port via the **EVAL-SDP-CS1Z** when the software is launched, a connectivity error displays (see Figure 14). Connect the evaluation system to the USB port of the PC, wait a few seconds, and then follow the on-screen instructions.

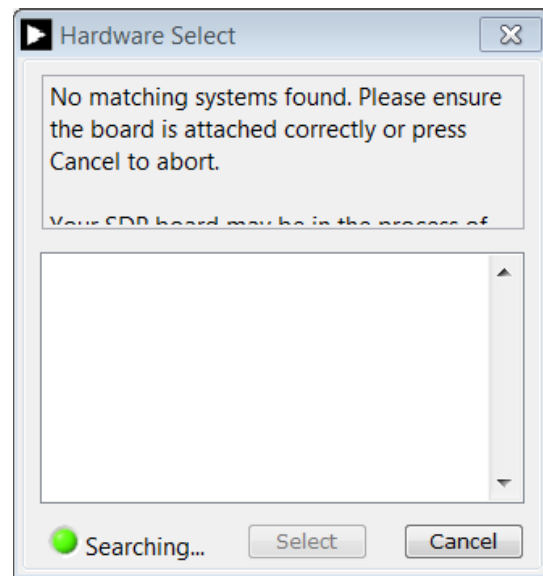

Figure 14. Connectivity Error Alert

When the **AD5535B** evaluation board software starts running, it searches for hardware connected to the PC. A dialog box indicates when the evaluation board attached to the PC is detected, and then the evaluation software main window appears (see Figure 15).

OVERVIEW OF THE MAIN WINDOW

The main window of the [AD5535B](#) evaluation board software is shown in Figure 15. The software has the following features.

RESET

RESET OFF is the default configuration, and the selection must be in this condition to update the device.

Update Single Channel

Clicking **Update Single Channel** performs a single channel update to the selected DAC channel with the value entered in the **DAC Code** field.

Update All Channels

Clicking **Update All Channels** updates all DAC channels with the value entered in the **DAC Code** field.

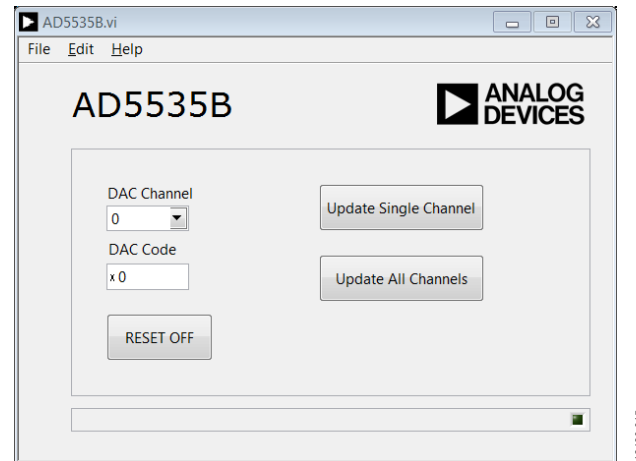

Figure 15. Evaluation Board Software Main Window

RELATED LINKS

Resource	Description
AD5535B	32-channel, 14-bit, high voltage output DAC
REF198	4.096 V, precision micropower, low dropout, low voltage reference
EngineerZone	Analog Devices, Inc., online technical support community

**ESD Caution**

ESD (electrostatic discharge) sensitive device. Charged devices and circuit boards can discharge without detection. Although this product features patented or proprietary protection circuitry, damage may occur on devices subjected to high energy ESD. Therefore, proper ESD precautions should be taken to avoid performance degradation or loss of functionality.

Legal Terms and Conditions

By using the evaluation board discussed herein (together with any tools, components documentation or support materials, the "Evaluation Board"), you are agreeing to be bound by the terms and conditions set forth below ("Agreement") unless you have purchased the Evaluation Board, in which case the Analog Devices Standard Terms and Conditions of Sale shall govern. Do not use the Evaluation Board until you have read and agreed to the Agreement. Your use of the Evaluation Board shall signify your acceptance of the Agreement. This Agreement is made by and between you ("Customer") and Analog Devices, Inc. ("ADI"), with its principal place of business at One Technology Way, Norwood, MA 02062, USA. Subject to the terms and conditions of the Agreement, ADI hereby grants to Customer a free, limited, personal, temporary, non-exclusive, non-sublicensable, non-transferable license to use the Evaluation Board FOR EVALUATION PURPOSES ONLY. Customer understands and agrees that the Evaluation Board is provided for the sole and exclusive purpose referenced above, and agrees not to use the Evaluation Board for any other purpose. Furthermore, the license granted is expressly made subject to the following additional limitations: Customer shall not (i) rent, lease, display, sell, transfer, assign, sublicense, or distribute the Evaluation Board; and (ii) permit any Third Party to access the Evaluation Board. As used herein, the term "Third Party" includes any entity other than ADI, Customer, their employees, affiliates and in-house consultants. The Evaluation Board is NOT sold to Customer; all rights not expressly granted herein, including ownership of the Evaluation Board, are reserved by ADI. CONFIDENTIALITY. This Agreement and the Evaluation Board shall all be considered the confidential and proprietary information of ADI. Customer may not disclose or transfer any portion of the Evaluation Board to any other party for any reason. Upon discontinuation of use of the Evaluation Board or termination of this Agreement, Customer agrees to promptly return the Evaluation Board to ADI. ADDITIONAL RESTRICTIONS. Customer may not disassemble, decompile or reverse engineer chips on the Evaluation Board. Customer shall inform ADI of any occurred damages or any modifications or alterations it makes to the Evaluation Board, including but not limited to soldering or any other activity that affects the material content of the Evaluation Board. Modifications to the Evaluation Board must comply with applicable law, including but not limited to the RoHS Directive. TERMINATION. ADI may terminate this Agreement at any time upon giving written notice to Customer. Customer agrees to return to ADI the Evaluation Board at that time. LIMITATION OF LIABILITY. THE EVALUATION BOARD PROVIDED HEREUNDER IS PROVIDED "AS IS" AND ADI MAKES NO WARRANTIES OR REPRESENTATIONS OF ANY KIND WITH RESPECT TO IT. ADI SPECIFICALLY DISCLAIMS ANY REPRESENTATIONS, ENDORSEMENTS, GUARANTEES, OR WARRANTIES, EXPRESS OR IMPLIED, RELATED TO THE EVALUATION BOARD INCLUDING, BUT NOT LIMITED TO, THE IMPLIED WARRANTY OF MERCHANTABILITY, TITLE, FITNESS FOR A PARTICULAR PURPOSE OR NON-INFRINGEMENT OF INTELLECTUAL PROPERTY RIGHTS. IN NO EVENT WILL ADI AND ITS LICENSORS BE LIABLE FOR ANY INCIDENTAL, SPECIAL, INDIRECT, OR CONSEQUENTIAL DAMAGES RESULTING FROM CUSTOMER'S POSSESSION OR USE OF THE EVALUATION BOARD, INCLUDING BUT NOT LIMITED TO LOST PROFITS, DELAY COSTS, LABOR COSTS OR LOSS OF GOODWILL. ADI'S TOTAL LIABILITY FROM ANY AND ALL CAUSES SHALL BE LIMITED TO THE AMOUNT OF ONE HUNDRED US DOLLARS (\$100.00). EXPORT. Customer agrees that it will not directly or indirectly export the Evaluation Board to another country, and that it will comply with all applicable United States federal laws and regulations relating to exports. GOVERNING LAW. This Agreement shall be governed by and construed in accordance with the substantive laws of the Commonwealth of Massachusetts (excluding conflict of law rules). Any legal action regarding this Agreement will be heard in the state or federal courts having jurisdiction in Suffolk County, Massachusetts, and Customer hereby submits to the personal jurisdiction and venue of such courts. The United Nations Convention on Contracts for the International Sale of Goods shall not apply to this Agreement and is expressly disclaimed.