

200-V Half-Bridge Driver

Features

- I_{O+} / I_{O-} of 290 mA / 600 mA typical gate current
- Gate drive voltage up to 20 V per channel
- Independent under-voltage lockout for V_{CC} , V_{BS}
- 3.3 V, 5 V, 15 V input logic compatible
- Tolerant to negative transient voltage
- Designed for use with bootstrap power supplies
- Cross-conduction prevention logic
- Matched propagation delay for both channels
- Internal set dead-time
- High-side output in phase with HIN input
- Low-side output out of phase with \overline{LIN} input
- -40 °C to 125 °C operating range
- 2 kV HBM ESD
- RoHS compliant

Description

The IRS2007S is a high voltage, high speed power MOSFET driver with dependent high and low side referenced output channels. Proprietary HVIC and latch immune CMOS technologies enable ruggedized monolithic construction. The logic input is compatible with standard CMOS or LSTTL output, down to 3.3 V logic. The output drivers feature a high pulse current buffer stage designed for minimum driver cross-conduction. The floating channel can be used to drive an N-channel power MOSFET or IGBT in the high side configuration which operates up to 200 V. Propagation delays are matched to simplify the HVIC's use in high frequency applications.

Product Summary

V_{OFFSET}	$\leq 200 \text{ V}$
V_{OUT}	10 V – 20 V
$I_{O+} \ \& \ I_{O-}$ (typ.)	290 mA & 600 mA
$t_{\text{ON}} \ \& \ t_{\text{OFF}}$ (typ.)	160 ns & 150 ns
Dead-time (typ.)	520 ns

Package Options



Typical Applications

- Battery operated power tools
- Battery operated garden equipment
- Light electric vehicles (e-bikes, e-scooters, e-toys)
- Wireless Charging
- Other general battery driven applications

Base Part Number	Package Type	Standard Pack		Orderable Part Number
		Form	Quantity	
IRS2007SPBF	8-Lead SOIC	Tube/Bulk	95	IRS2007SPBF
		Tape and Reel	2500	IRS2007STRPBF

Typical Connection Diagram

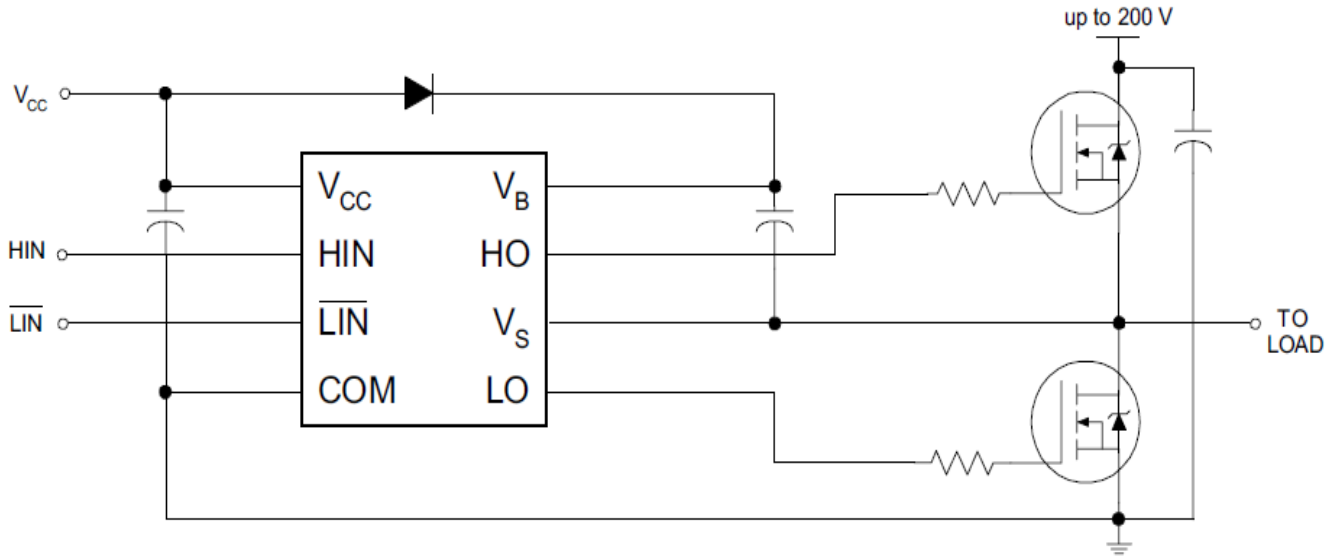

(Refer to Lead Assignments for correct pin configuration). This diagram shows electrical connections only. Please refer our Application Notes & Design Tips for proper circuit board layout.

Absolute Maximum Ratings

Absolute maximum ratings indicate sustained limits beyond which damage to the device may occur. All voltage parameters are absolute voltages referenced to COM unless otherwise stated in the table. The thermal resistance and power dissipation ratings are measured under board mounted and still air conditions.

Symbol	Definition	Min.	Max.	Units	
V_{CC}	Low side supply voltage	-0.3	25 [†]	V	
V_{IN}	Logic input voltage (HIN & \overline{LIN})	COM - 0.3	$V_{CC} + 0.3$		
V_B	High-side floating well supply voltage	-0.3	225		
V_S	High-side floating well supply return voltage	$V_B - 25$	$V_B + 0.3$		
V_{HO}	Floating gate drive output voltage	$V_S - 0.3$	$V_B + 0.3$		
V_{LO}	Low-side output voltage	COM - 0.3	$V_{CC} + 0.3$		
COM	Power ground	$V_{CC} - 25$	$V_{CC} + 0.3$		
dV_S/dt	Allowable V_S offset supply transient relative to COM	—	50	V/ns	
P_D	Package power dissipation @ $T_A \leq +25$ °C	8-Lead SOIC	—	0.625	W
R_{thJA}	Thermal resistance, junction to ambient	8-Lead SOIC	—	200	°C/W
T_J	Junction temperature	—	150	°C	
T_S	Storage temperature	-55	150		
T_L	Lead temperature (soldering, 10 seconds)	—	300		

† All supplies are tested at 25 V.

Recommended Operating Conditions

For proper operation, the device should be used within the recommended conditions. All voltage parameters are absolute voltages referenced to COM unless otherwise stated in the table. The offset rating is tested with supplies of $(V_{CC} - COM) = (V_B - V_S) = 15$ V.

Symbol	Definition	Min	Max	Units
V_{CC}	Low-side supply voltage	10	20	V
V_{IN}	Logic input voltage(HIN & \overline{LIN})	0	V_{CC}	
V_B	High-side floating well supply voltage	$V_S + 10$	$V_S + 20$	
V_S	High-side floating well supply offset voltage [†]	COM - 8 [†]	200	
V_{HO}	Floating gate drive output voltage	V_S	V_B	
V_{LO}	Low-side output voltage	COM	V_{CC}	
T_A	Ambient temperature	-40	125	°C

† Logic operation for V_S of -8 V to 200 V. Logic state held for V_S of -8 V to $-V_{BS}$. Please refer to Design Tip DT97-3 for more details.

Static Electrical Characteristics

$(V_{CC} - COM) = (V_B - V_S) = 15V$. $T_A = 25^\circ C$ unless otherwise specified. The V_{IN} and I_{IN} parameters are referenced to COM. The V_O and I_O parameters are referenced to respective V_S and COM and are applicable to the respective output leads HO or LO. The V_{CCUV} parameters are referenced to COM. The V_{BSUV} parameters referenced to V_S . Output Current Direction is defined as positive out of the pin and negative into the pin

Symbol	Definition	Min.	Typ.	Max.	Units	Test Conditions
V_{BSUV+}	V_{BS} supply under voltage positive threshold	8.0	8.9	9.8	V	
V_{BSUV-}	V_{BS} supply under voltage negative threshold	7.4	8.2	9		
V_{BSUVHY}	V_{BS} supply under voltage hysteresis	—	0.7	—		
V_{CCUV+}	V_{CC} supply under voltage positive threshold	8.0	8.9	9.8		
V_{CCUV-}	V_{CC} supply under voltage negative threshold	7.4	8.2	9		
V_{CCUVHY}	V_{CC} supply under voltage hysteresis	—	0.7	—		
I_{LK}	High-side floating well offset supply leakage	—	—	50	μA	$V_B = V_S = 200 V$
I_{QBS}	Quiescent V_{BS} supply current	—	45	75		All inputs are in the off state
I_{QCC}	Quiescent V_{CC} supply current	—	300	520		
V_{OH}	High level output voltage drop, $V_{BIAS}-V_O$	—	0.05	0.2	V	$I_O = 2 mA$
V_{OL}	Low level output voltage drop, V_O	—	0.02	0.1		
I_{O+}	Output high short circuit pulsed current	200	290	—	mA	$V_O = 0 V, V_{IN} = V_{IH}$ $PW \leq 10 \mu s$
$ I_{O-} $	Output low short circuit pulsed current	420	600	—		$V_O = 15 V,$ $V_{IN} = V_{IL}$ $PW \leq 10 \mu s$
V_{IH}	Logic "1" (HIN) & Logic "0" (\overline{LIN}) input voltage	2.5	—	—	V	$V_{CC}=10 V - 20 V$
V_{IL}	Logic "0" (HIN) & Logic "1" (\overline{LIN}) input voltage	—	—	0.8		
I_{IN+}	Logic "1" Input bias current	—	3	10	μA	$HIN = 5 V$ $\overline{LIN} = 0 V$
I_{IN-}	Logic "0" Input bias current	—	—	5		$HIN = 0 V$ $\overline{LIN} = 5 V$

Dynamic Electrical Characteristics

$V_{CC} = V_B = 15V$, $V_S = COM$, $T_A = 25^\circ C$, and $C_L = 1000pF$ unless otherwise specified.

Symbol	Definition	Min.	Typ.	Max.	Units	Test Conditions
t_{ON}	Turn-on propagation delay	—	160	220	ns	$V_S = 0 V$ or $200 V$
t_{OFF}	Turn-off propagation delay	—	150	220		
t_R	Turn-on rise time	—	70	170		
t_F	Turn-off fall time	—	30	90		
MT	Delay matching time (t_{ON}, t_{OFF})	—	—	50		
DT	Deadtime, LO turn-off to HO turn-on & HO turn-off to LO turn-on	400	520	650		
MDT	Deadtime matching = $ DT_{LO-HO} - DT_{HO-LO} $	—	—	30		

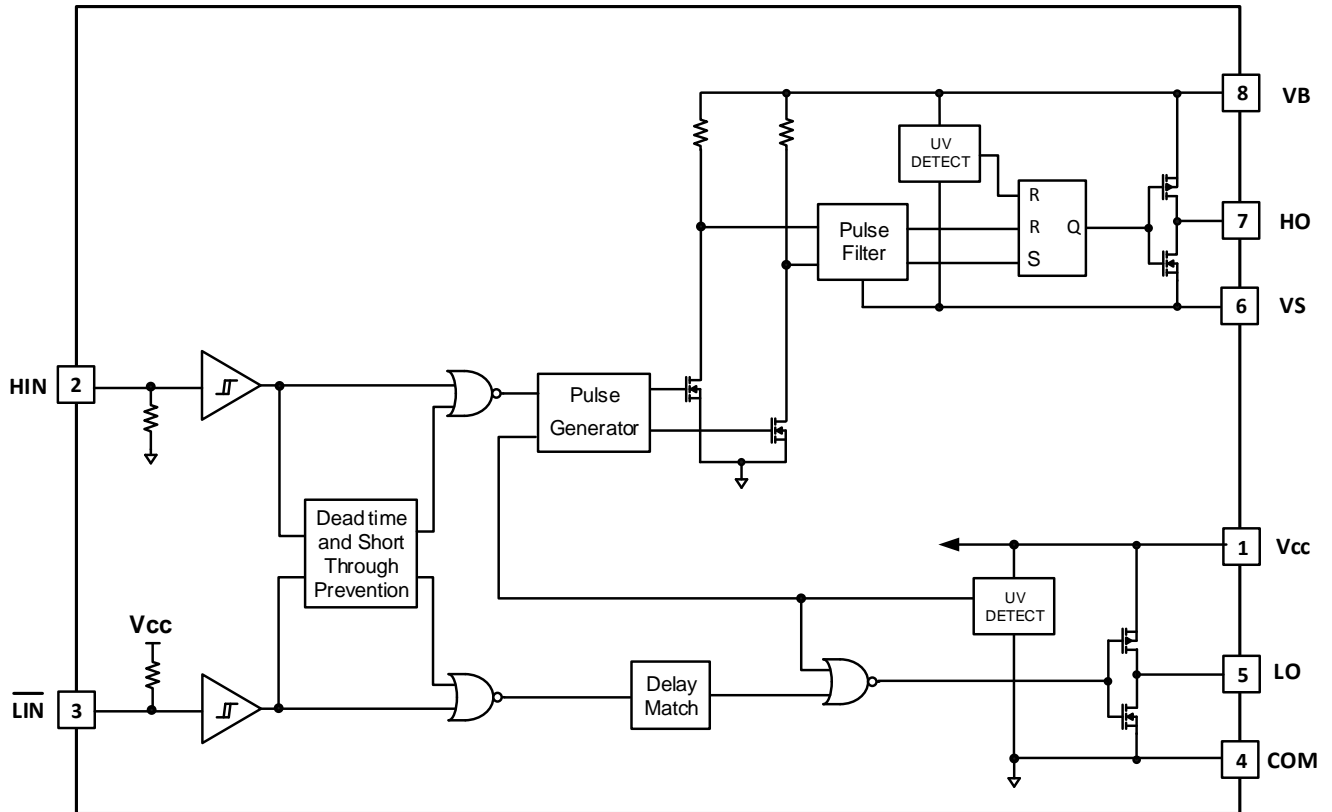
Functional Block Diagram

Lead Definitions

Symbol	Description
V _{CC}	Low-side and logic supply voltage
V _B	High-side gate drive floating supply
V _S	High voltage floating supply return
HIN	Logic inputs for high-side gate driver output (HO), in phase
$\overline{\text{LIN}}$	Logic inputs for low-side gate driver output (LO), out of phase
HO	High-side driver output
LO	Low-side driver output
COM	Low-side gate drive return

Lead Assignments

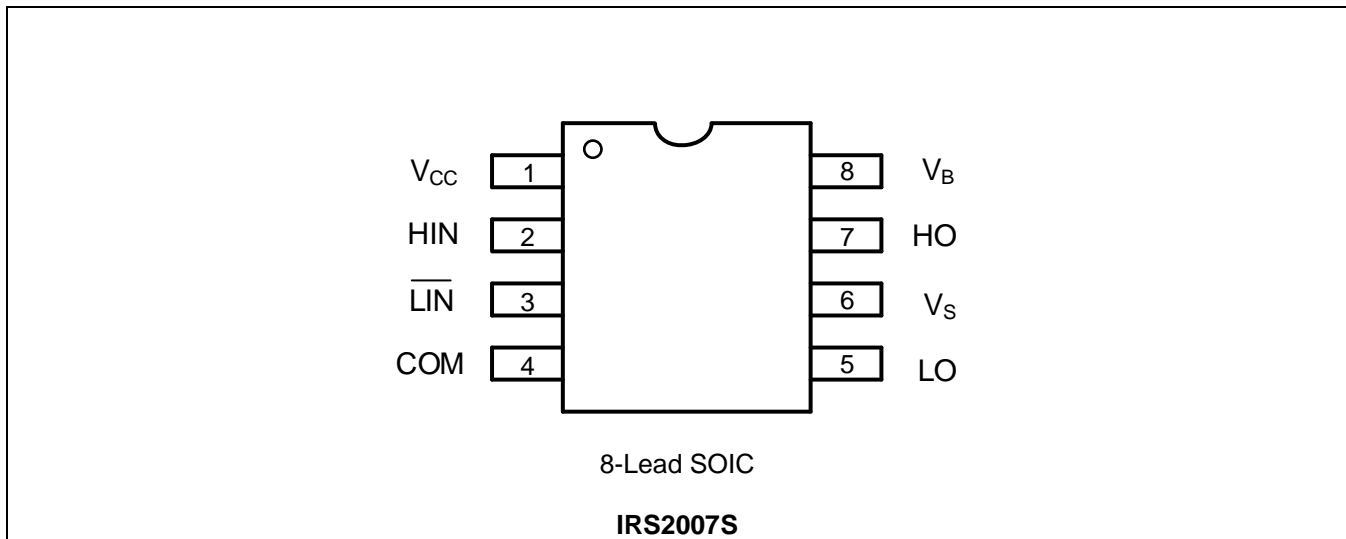

Application Information and Additional Details

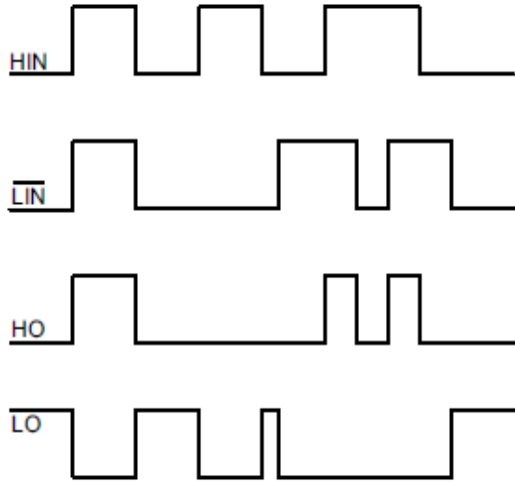

Figure 1. Input/Output Timing Diagram

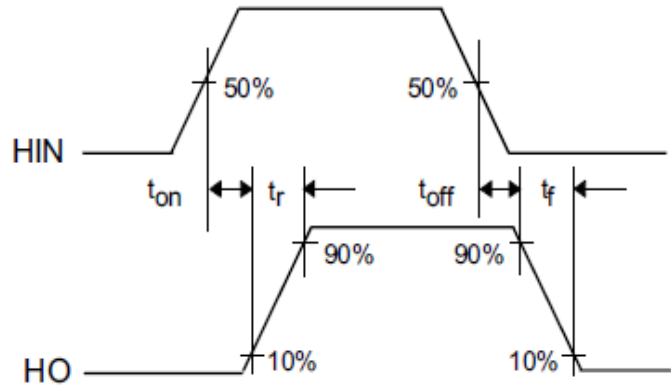
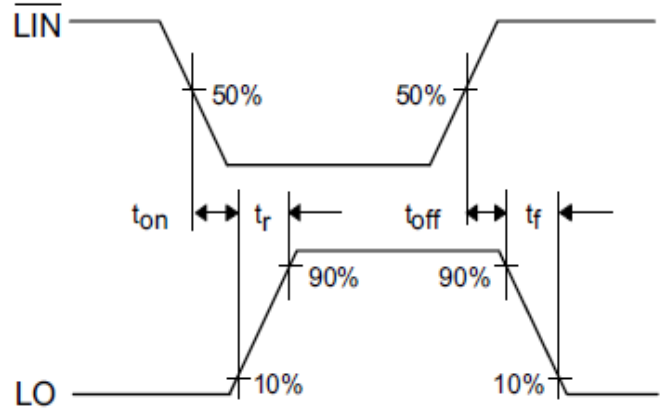

Figure 2. Switching Time Waveform Definitions

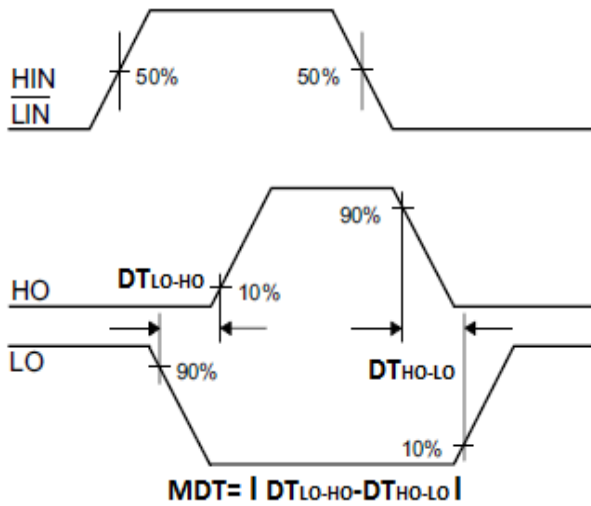

Figure 3. Deadtime Waveform Definitions

Parameters trend with different temperature and voltage bias. (Fig. 4 ~ Fig. 20)

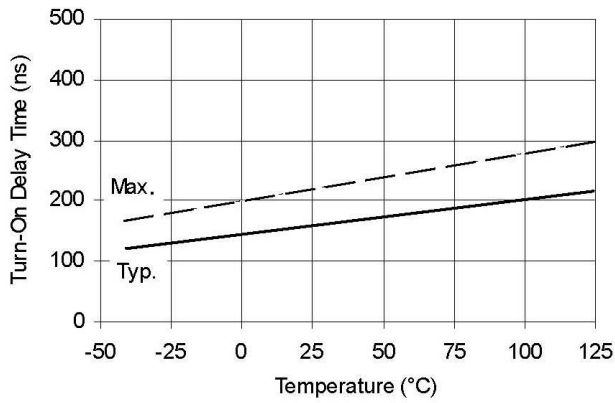

Figure 4A. Turn-On Time vs. Temperature

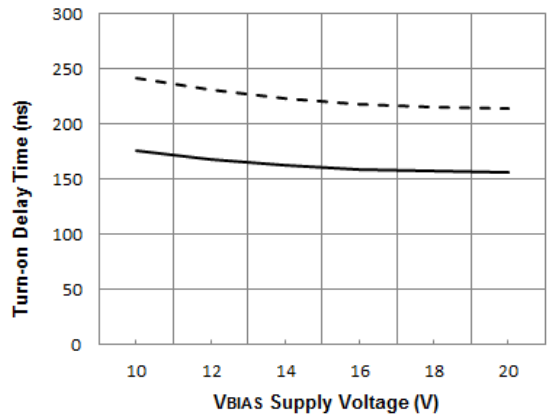

Figure 4B. Turn-On Time vs. Supply Voltage

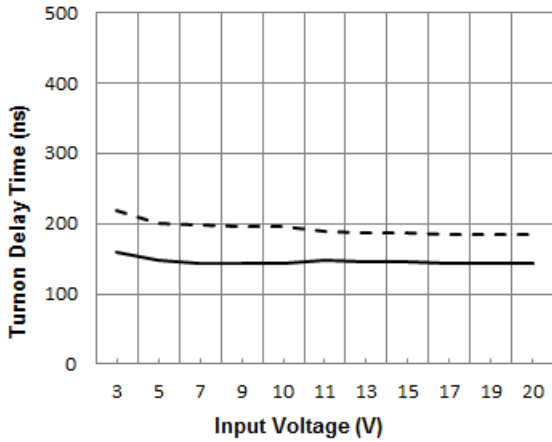

Figure 4C. Turn-On Time vs. Input Voltage

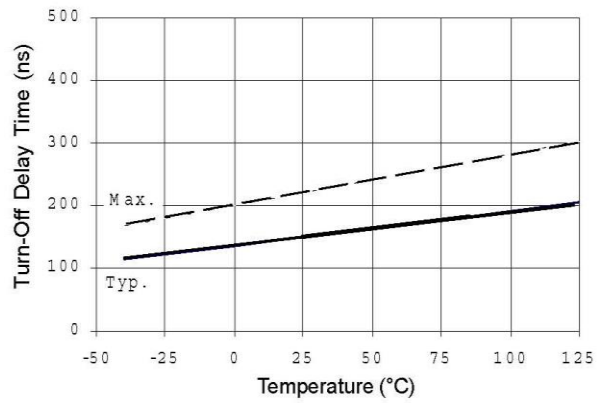

Figure 5A. Turn-Off Time vs. Temperature

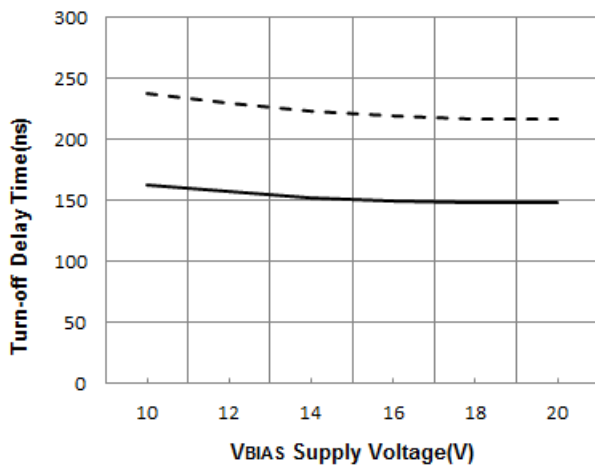

Figure 5B. Turn-Off Time vs. Supply Voltage

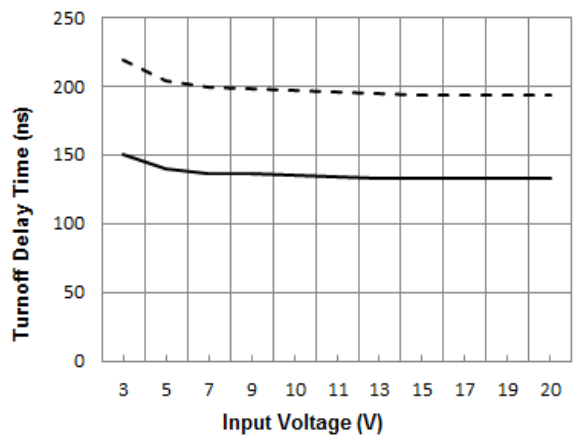

Figure 5C. Turn-Off Time vs. Input Voltage

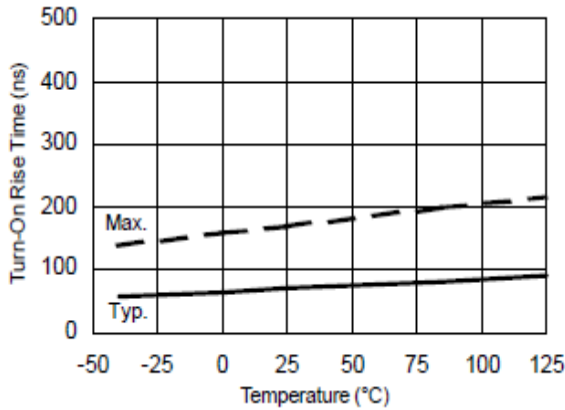

Figure 6A. Turn-On Rise Time vs. Temperature

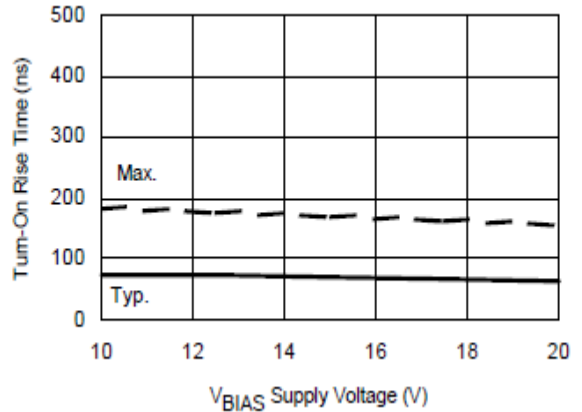

Figure 6B. Turn-On Rise Time vs. Voltage

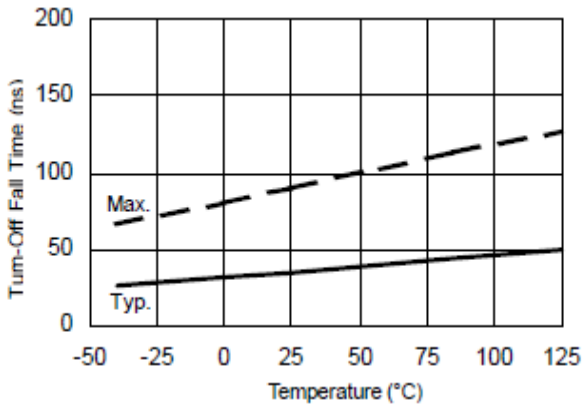

Figure 7A. Turn-Off Fall Time vs. Temperature

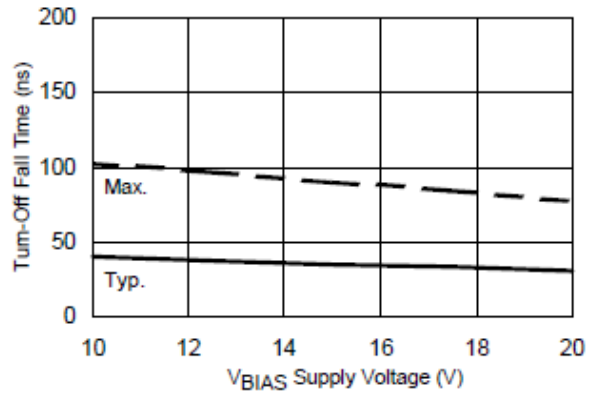

Figure 7B. Turn-Off Fall Time vs. Voltage

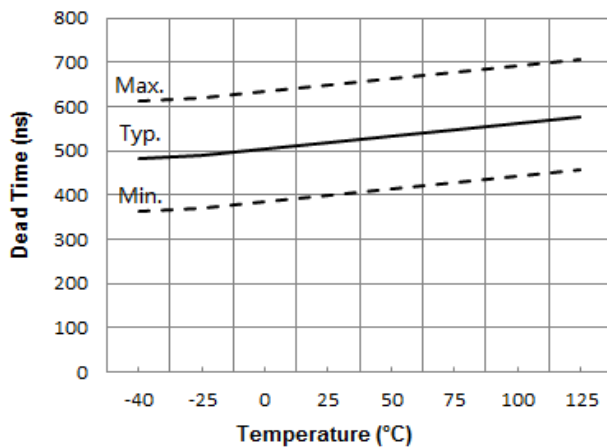

Figure 8A. Deadtime vs. Temperature

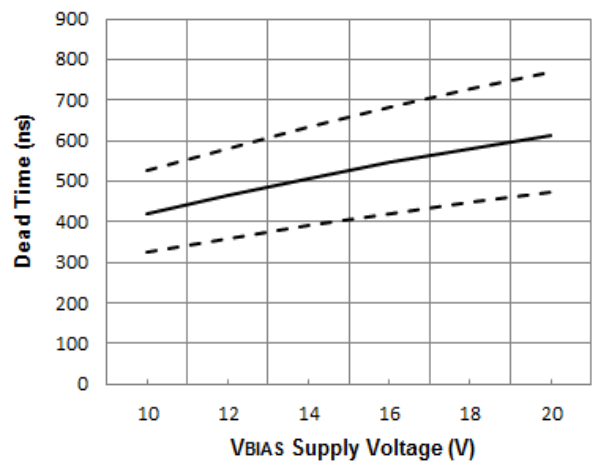

Figure 8B. Deadtime vs. Supply Voltage

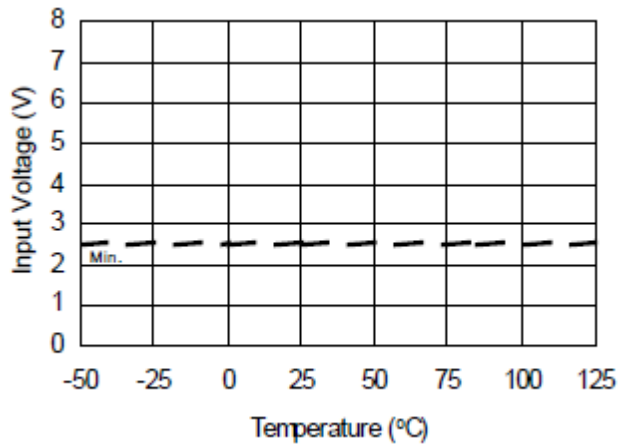

Figure 9A. Logic "1"(HIN) & Logic "0"(LIN) Input Voltage vs. Temperature

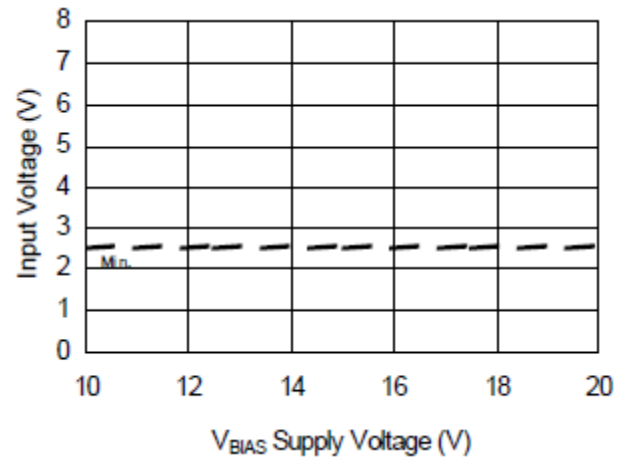

Figure 9B. Logic "1"(HIN) & Logic "0"(LIN) Input Voltage vs. Supply Voltage

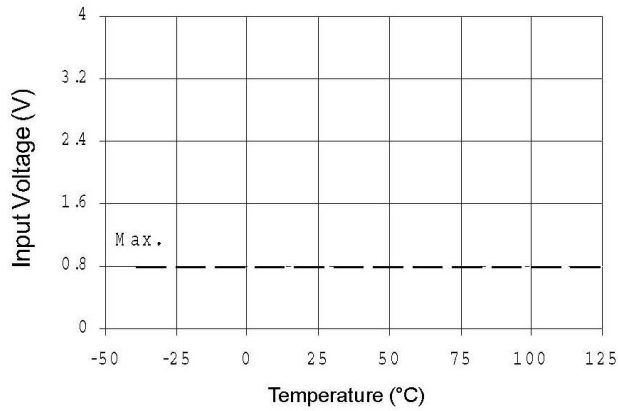

Figure 10A. Logic "0"(HIN) & Logic "1"(LIN) Input Voltage vs. Temperature

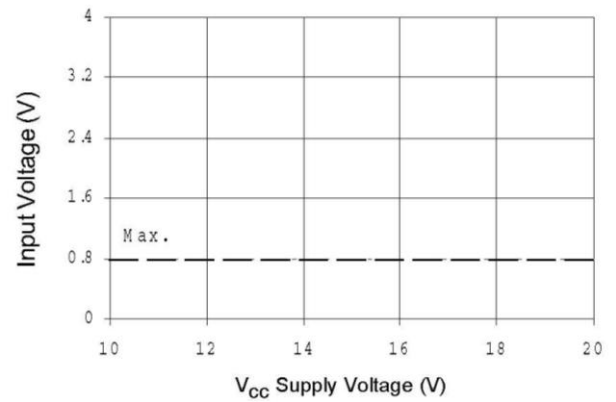

Figure 10B. Logic "0"(HIN) & Logic "1"(LIN) Input Voltage vs. Supply Voltage

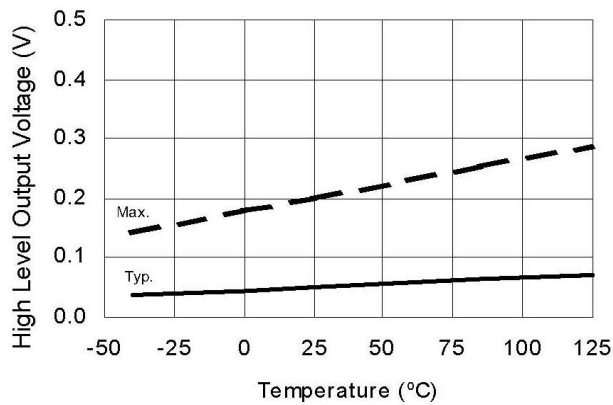

Figure 11A. High Level Output Voltage vs. Temperature

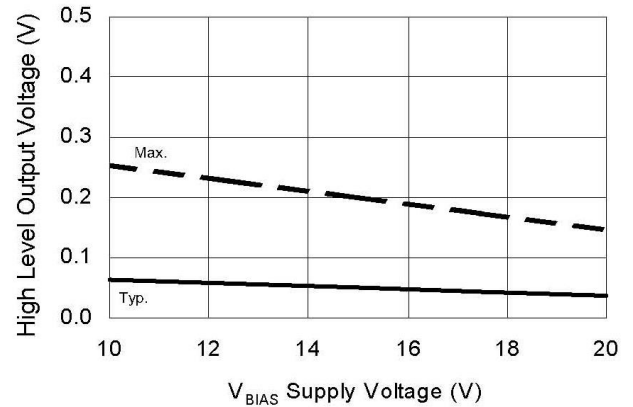

Figure 11B. High Level Output Voltage vs. Supply Voltage

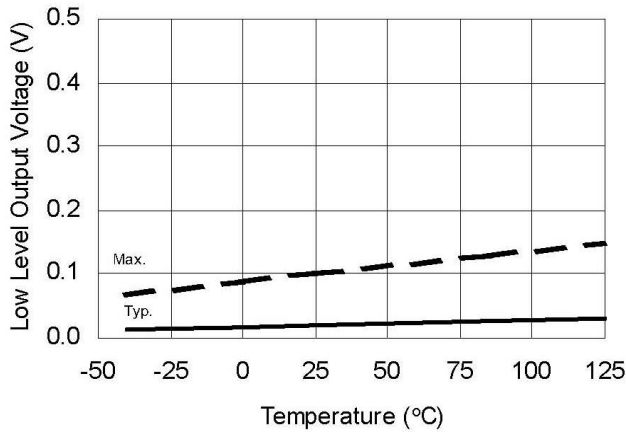

Figure 12A. Low Level Output Voltage vs. Temperature

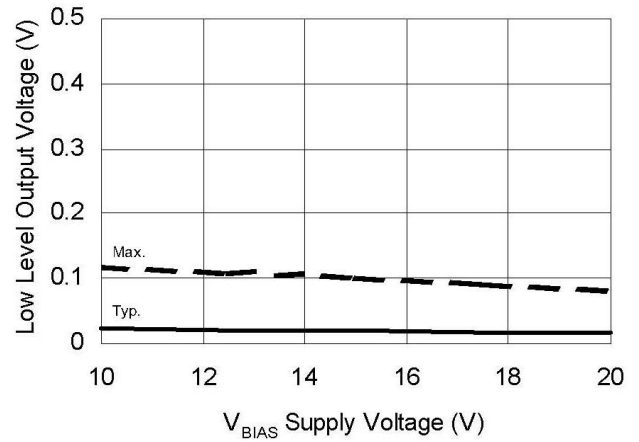

Figure 12B. Low Level Output Voltage vs. Supply Voltage

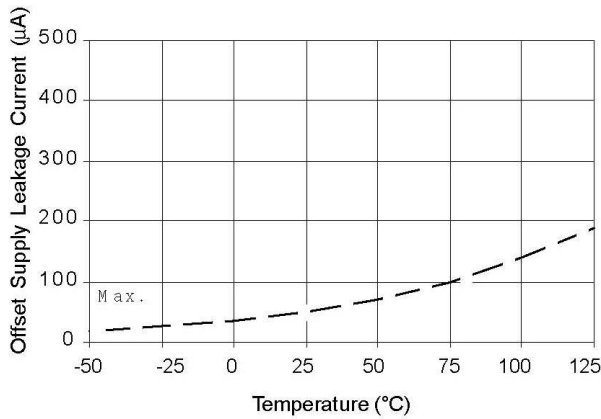

Figure 13A. Offset Supply Current vs. Temperature

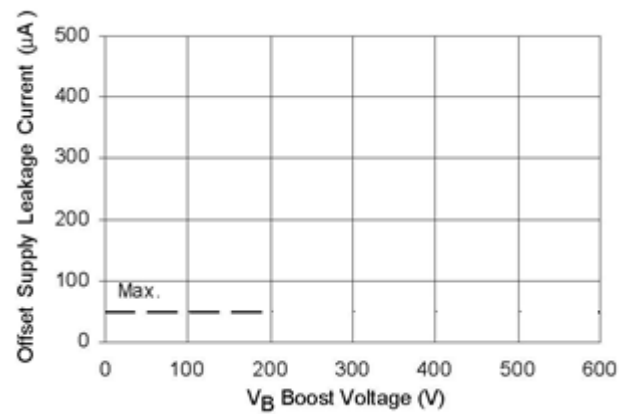

Figure 13B. Offset Supply Current vs. Boost Voltage

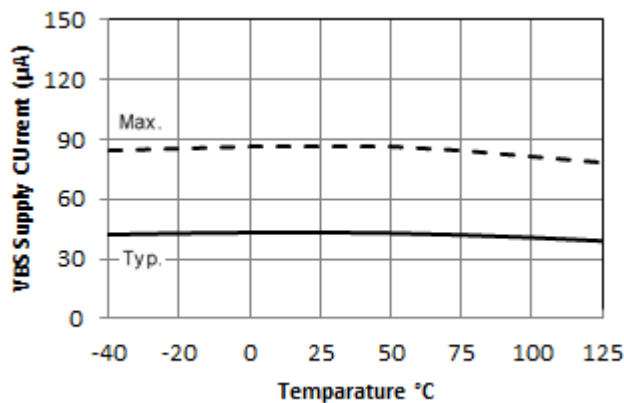

Figure 14A. V_{BS} Supply Current vs. Temperature

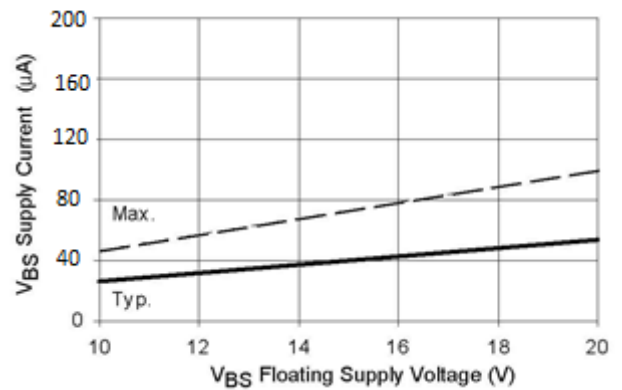

Figure 14B. V_{BS} Supply Current vs. Supply Voltage

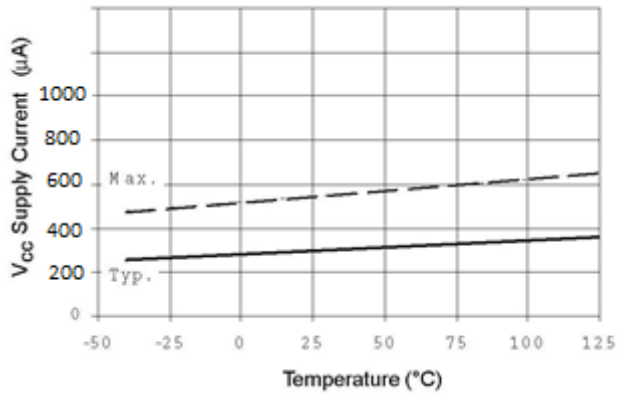

Figure 15A. V_{CC} Supply Current vs. Temperature

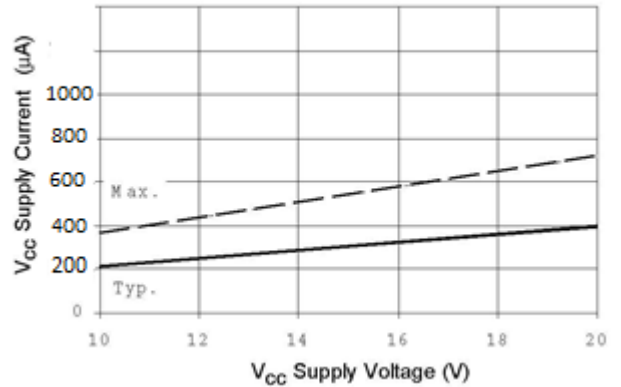

Figure 15B. V_{CC} Supply Current vs. Supply Voltage

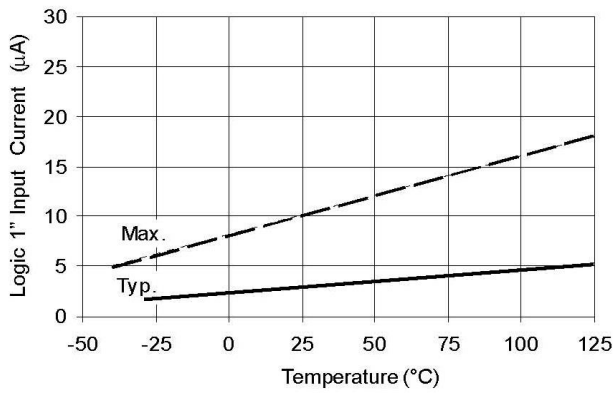

Figure 16A. Logic "1" Input Current vs. Temperature

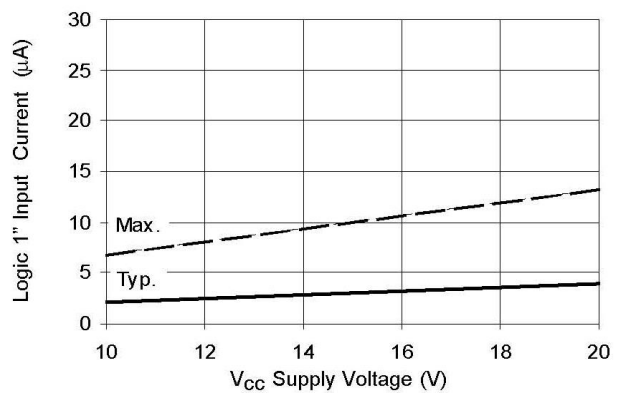

Figure 16B. Logic "1" Input Current vs. Supply Voltage

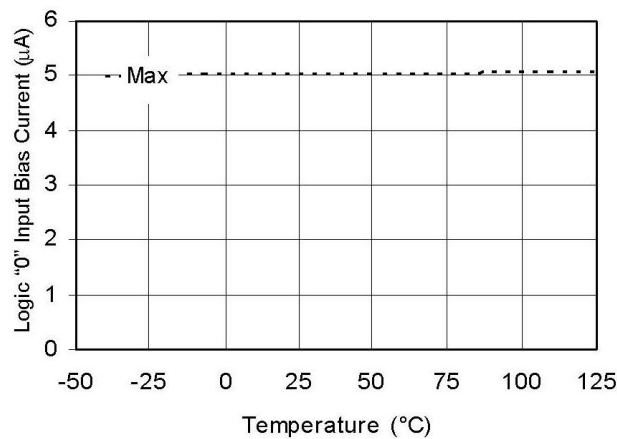

Figure 17A. Logic "0" Input Bias Current vs. Temperature

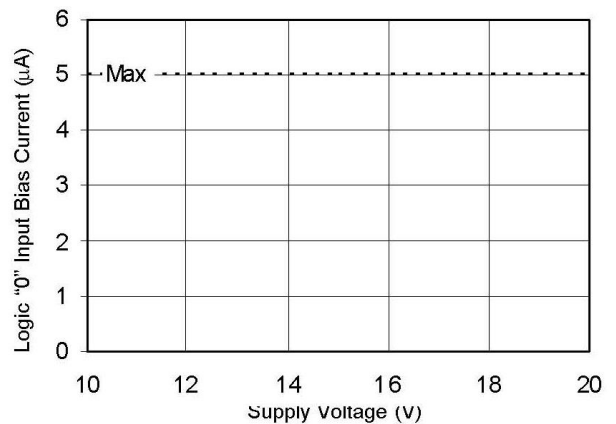

Figure 17B. Logic "0" Input Bias Current vs. Supply Voltage

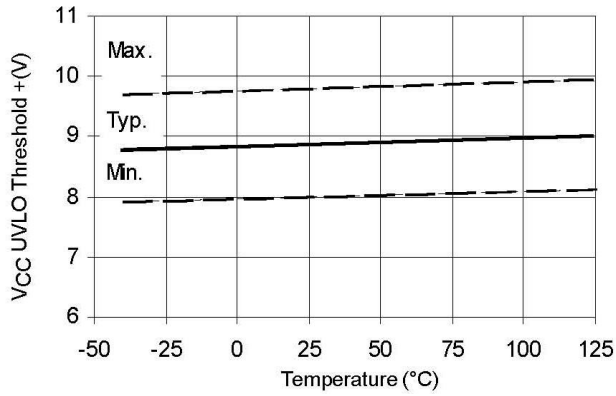

Figure 18A. V_{CC}/V_{BS} Under-voltage Threshold(+) vs. Temperature

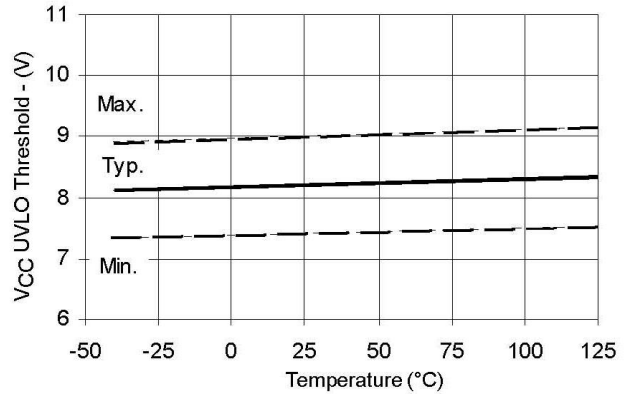

Figure 18B. V_{CC}/V_{BS} Under-voltage Threshold(-) vs. Temperature

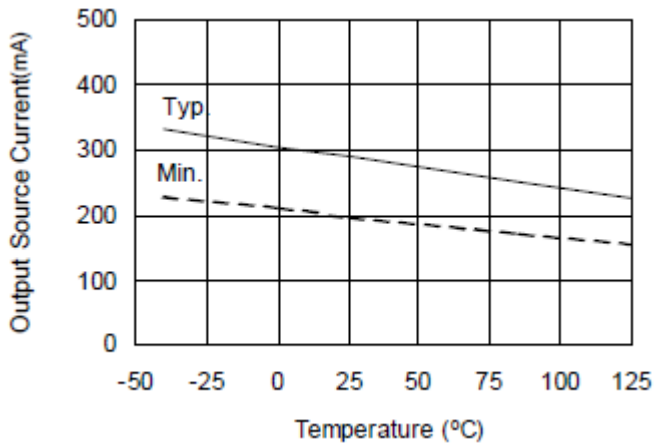

Figure 19A. Output Source Current vs. Temperature

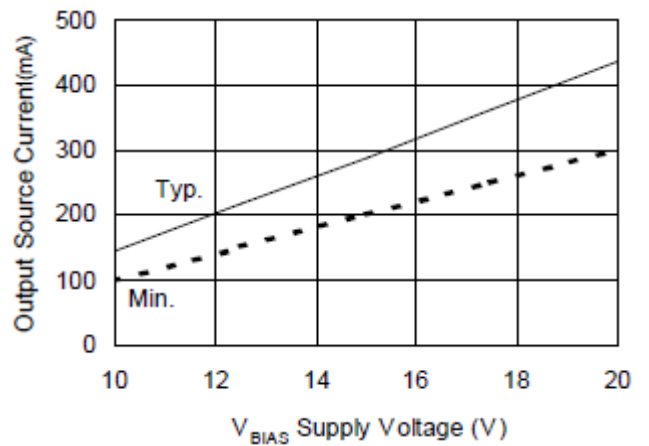

Figure 19B. Output Source Current vs. Supply Voltage

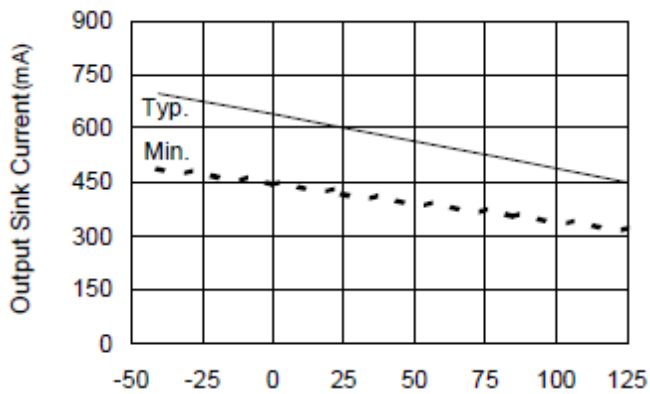

Figure 20A. Output Sink Current vs. Temperature

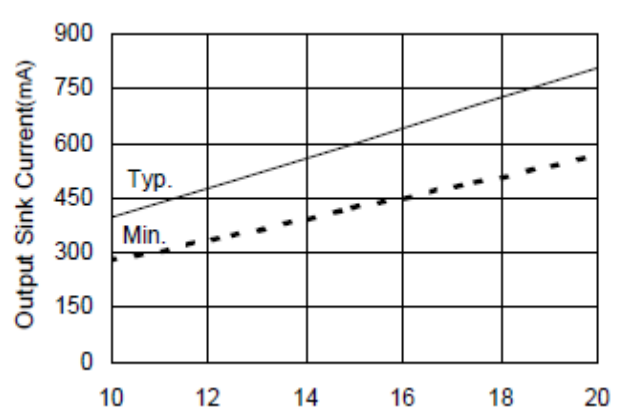
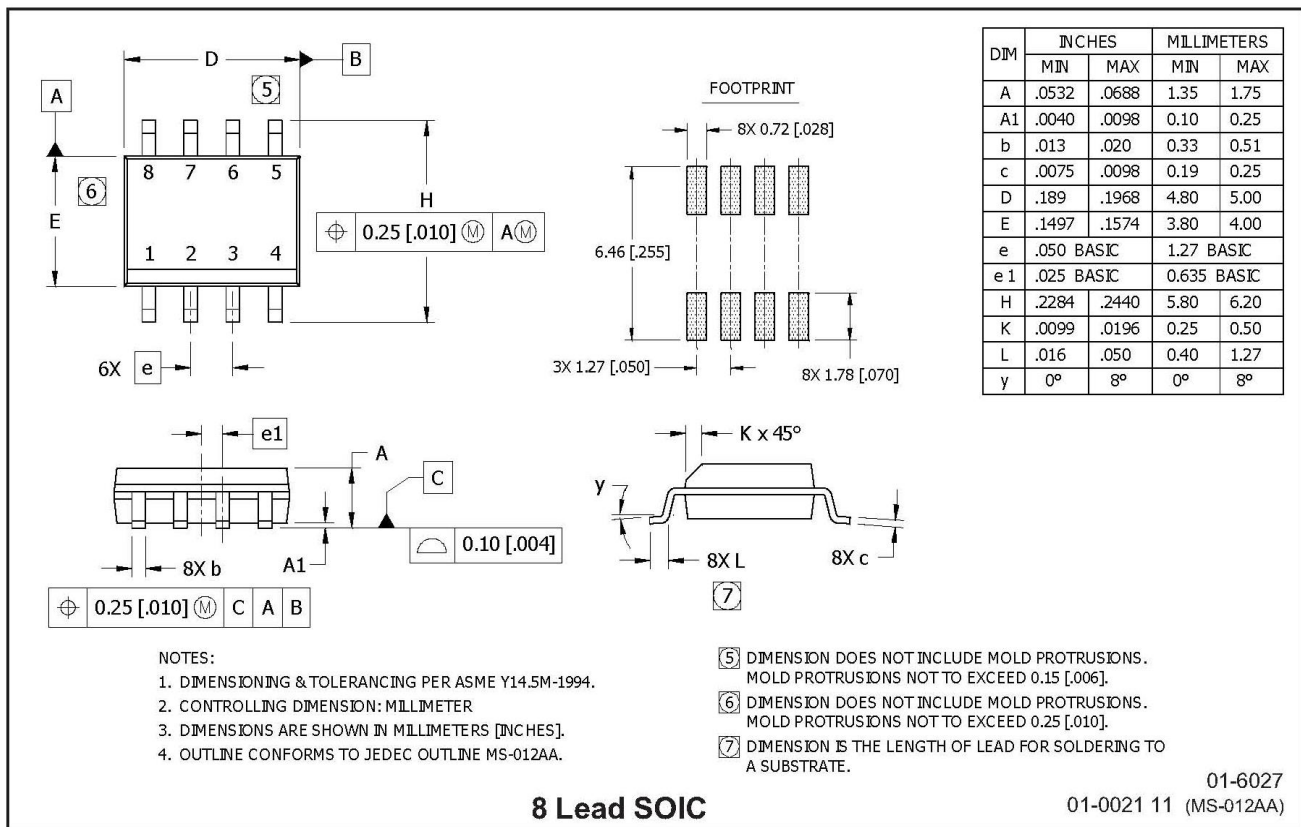
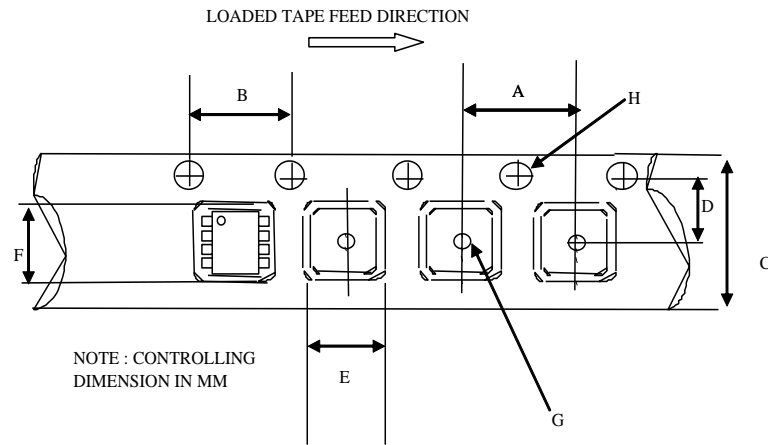

Figure 20B. Output Sink Current vs. Supply Voltage

Package Details: 8-Lead SOIC

Tape and Reel Details: 8-Lead SOIC



CARRIER TAPE DIMENSION FOR 8SOICN

Code	Metric		Imperial	
	Min	Max	Min	Max
A	7.90	8.10	0.311	0.318
B	3.90	4.10	0.153	0.161
C	11.70	12.30	0.46	0.484
D	5.45	5.55	0.214	0.218
E	6.30	6.50	0.248	0.255
F	5.10	5.30	0.200	0.208
G	1.50	n/a	0.059	n/a
H	1.50	1.60	0.059	0.062

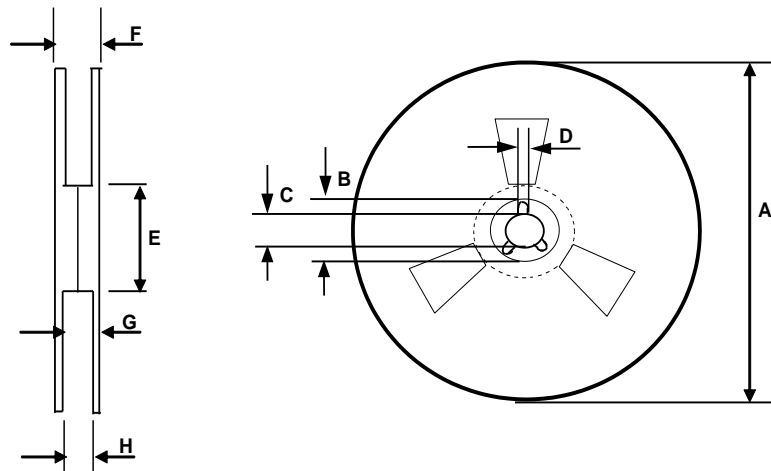

REEL DIMENSIONS FOR 8SOICN

Code	Metric		Imperial	
	Min	Max	Min	Max
A	329.60	330.25	12.976	13.001
B	20.95	21.45	0.824	0.844
C	12.80	13.20	0.503	0.519
D	1.95	2.45	0.767	0.096
E	98.00	102.00	3.858	4.015
F	n/a	18.40	n/a	0.724
G	14.50	17.10	0.570	0.673
H	12.40	14.40	0.488	0.566

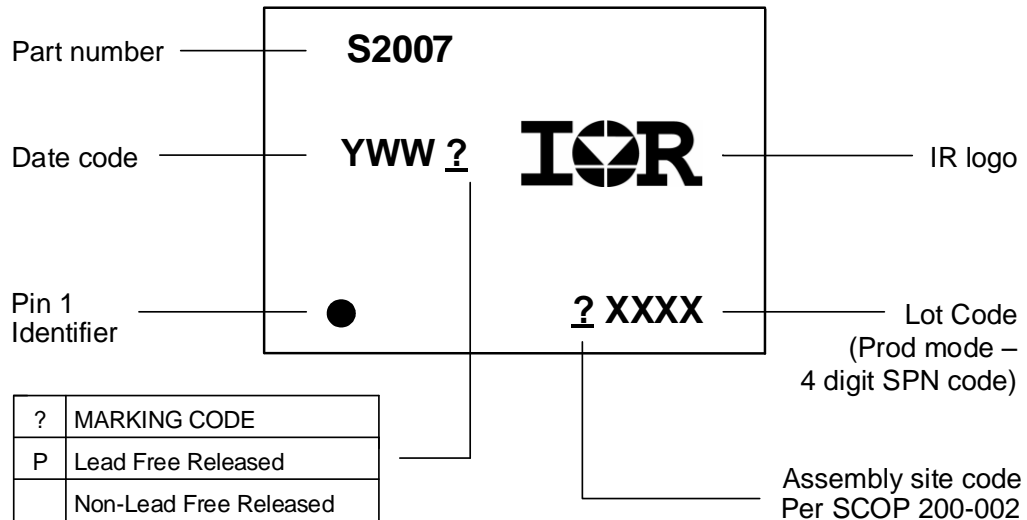
Part Marking Information

**8-Lead SOIC8
IRS2007SPBF**

Qualification Information[†]

Qualification Level		Industrial ^{††}	
		Comments: This family of ICs has passed JEDEC's Industrial qualification. Consumer qualification level is granted by extension of the higher Industrial level.	
Moisture Sensitivity Level		8 Lead SOIC	MSL2 ^{†††} , 260°C (per IPC/JEDEC J-STD-020)
ESD	Human Body Model	Class 2 (per JEDEC standard JESD22-A114)	
	Machine Model	Class A (per EIA/JEDEC standard EIA/JESD22-A115)	
IC Latch-Up Test		Class I (per JESD78)	
RoHS Compliant		Yes	

† Higher qualification ratings may be available should the user have such requirements. Please contact your Infineon sales representative for further information.

†† Higher MSL ratings may be available for the specific package types listed here. Please contact your Infineon sales representative for further information.

**Published by
Infineon Technologies AG
81726 München, Germany
© Infineon Technologies AG 2017
All Rights Reserved.**

IMPORTANT NOTICE

The information given in this document shall in no event be regarded as a guarantee of conditions or characteristics (“Beschaffenhheitsgarantie”). With respect to any examples, hints or any typical values stated herein and/or any information regarding the application of the product, Infineon Technologies hereby disclaims any and all warranties and liabilities of any kind, including without limitation warranties of non-infringement of intellectual property rights of any third party.

In addition, any information given in this document is subject to customer’s compliance with its obligations stated in this document and any applicable legal requirements, norms and standards concerning customer’s products and any use of the product of Infineon Technologies in customer’s applications.

The data contained in this document is exclusively intended for technically trained staff. It is the responsibility of customer’s technical departments to evaluate the suitability of the product for the intended application and the completeness of the product information given in this document with respect to such application.

For further information on the product, technology, delivery terms and conditions and prices please contact your nearest Infineon Technologies office (www.infineon.com).

WARNINGS

Due to technical requirements products may contain dangerous substances. For information on the types in question please contact your nearest Infineon Technologies office.

Except as otherwise explicitly approved by Infineon Technologies in a written document signed by authorized representatives of Infineon Technologies, Infineon Technologies’ products may not be used in any applications where a failure of the product or any consequences of the use thereof can reasonably be expected to result in personal injury.