

## High temperature 50 A SCRs

Datasheet - production data

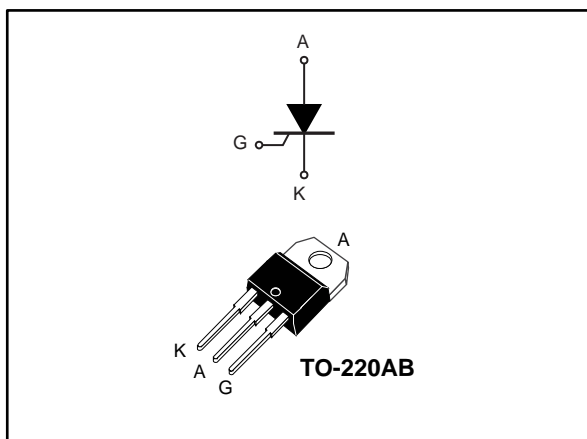

### Description

Packaged in a non-isolated TO-220AB, this device offers high thermal performance during operation of up to 50 A, thanks to a junction temperature of up to 150 °C.

Its noise immunity ( $dV/dt = 500 \text{ V}/\mu\text{s}$ ) trade-off versus gate triggering current ( $I_{GT} = 15 \text{ mA}$ ) and its turn-on current rise ( $dI/dt = 100 \text{ A}/\mu\text{s}$ ) allow the design of robust and compact control circuits for voltage regulators in motorbikes and industrial drives, overvoltage crowbar protection, motor control circuits in power tools and kitchen appliances, and inrush current-limiting circuits.

### Features

- High junction temperature:  $T_j = 150 \text{ °C}$
- High noise immunity up to 150 °C
- Gate triggering current  $I_{GT} = 15 \text{ mA}$
- Peak off-state voltage  $V_{DRM}/V_{RRM} = 600 \text{ V}$
- High turn-on current rise  $dI/dt = 100 \text{ A}/\mu\text{s}$
- ECOPACK<sup>®</sup>2 compliant component

### Applications

- Motorbike voltage regulator circuits
- Inrush current limiting circuits
- Motor control circuits and starters
- Solid state relays

**Table 1: Device summary**

| Order code | Package  | $V_{DRM}/V_{RRM}$ | $I_{GT}$ |
|------------|----------|-------------------|----------|
| TN5015H-6T | TO-220AB | 600 V             | 15 mA    |

# 1 Characteristics

**Table 2: Absolute maximum ratings (limiting values),  $T_j = 25\text{ °C}$  unless otherwise specified**

| Symbol            | Parameter   |                         | Value   | Unit      |
|-------------------|---|-------------------------|---|-----------|
| $I_{T(RMS)}$      | RMS on-state current<br>(180 ° conduction angle)  |                         | $T_c = 120\text{ °C}$<br>50                     | A         |
| $I_{T(AV)}$       | Average on-state current<br>(180 ° conduction angle)  |                         | $T_c = 122\text{ °C}$<br>30                     | A         |
|                   |   |                         | $T_c = 128\text{ °C}$<br>25                     |           |
|                   |   |                         | $T_c = 134\text{ °C}$<br>20                     |           |
| $I_{TSM}$         | Non repetitive surge peak on-state current<br>( $T_j$ initial = 25 °C)                          |                         | $t_p = 8.3\text{ ms}$<br>493                    | A         |
|                   |   |                         | $t_p = 10\text{ ms}$<br>450                     |           |
| $I^2t$            | $I^2t$ value for fusing   |                         | $t_p = 10\text{ ms}$<br>1012                    | $A^2s$    |
| $di/dt$           | Critical rate of rise of on-state current<br>$I_G = 2 \times I_{GT}$ , $t_r \leq 100\text{ ns}$ |                         | $f = 60\text{ Hz}$<br>100                       | $A/\mu s$ |
| $V_{DRM}/V_{RRM}$ | Repetitive peak off-state voltage   |                         | $T_j = 150\text{ °C}$<br>600                    | V         |
| $V_{DSM}/V_{RSM}$ | Non repetitive surge peak off-state voltage   |                         | $t_p = 10\text{ ms}$<br>$V_{DRM}/V_{RRM} + 100$ | V         |
| $I_{GM}$          | Peak gate current   | $t_p = 20\text{ }\mu s$ | $T_j = 150\text{ °C}$<br>4                      | A         |
| $P_{G(AV)}$       | Average gate power dissipation  |                         | $T_j = 150\text{ °C}$<br>1                      | W         |
| $V_{RGM}$         | Maximum peak reverse gate voltage   |                         | 5   | V         |
| $T_{stg}$         | Storage junction temperature range  |                         | -40 to +150                                     | °C        |
| $T_j$             | Maximum operating junction temperature  |                         | -40 to +150                                     | °C        |
| $T_l$             | Maximum lead temperature soldering during 10 s  |                         | 260   | °C        |

**Table 3: Electrical characteristics ( $T_j = 25\text{ °C}$  unless otherwise specified)**

| Symbol   | Test conditions  |                       | Value | Unit |           |
|----------|--|-----------------------|-------|------|-----------|
| $I_{GT}$ | $V_D = 12\text{ V}$ , $R_L = 33\text{ }\Omega$   |                       | Max.  | 15   | mA        |
| $V_{GT}$ |  |                       | Max.  | 1.3  | V         |
| $V_{GD}$ | $V_D = V_{DRM}$ , $R_L = 3.3\text{ k}\Omega$   | $T_j = 150\text{ °C}$ | Min.  | 0.15 | V         |
| $I_H$    | $I_T = 500\text{ mA}$ , gate open  |                       | Max.  | 60   | mA        |
| $I_L$    | $I_G = 1.2 \times I_{GT}$  |                       | Max.  | 80   | mA        |
| $dV/dt$  | $V_D = 402\text{ V}$ , gate open   | $T_j = 150\text{ °C}$ | Min.  | 500  | $V/\mu s$ |
| $t_{gt}$ | $I_{TM} = 100\text{ A}$ , $V_D = 402\text{ V}$ , $I_G = 30\text{ mA}$ , $(di_G/dt)_{max} = 0.2\text{ A}/\mu s$                             |                       | Typ.  | 1.9  | $\mu s$   |
| $t_q$    | $I_{TM} = 100\text{ A}$ , $V_D = 402\text{ V}$ , $(di/dt)_{off} = 30\text{ A}/\mu s$ , $V_R = 25\text{ V}$ , $dV_D/dt = 50\text{ V}/\mu s$ | $T_j = 150\text{ °C}$ | Typ.  | 85   | $\mu s$   |

Table 4: Static characteristics

| Symbol                | Test conditions   |                                     |      | Value | Unit          |
|-----------------------|---|-------------------------------------|------|-------|---------------|
| $V_{TM}$              | $I_{TM} = 100 \text{ A}$ , $t_p = 380 \text{ } \mu\text{s}$ | $T_j = 25 \text{ } ^\circ\text{C}$  | Max. | 1.65  | V             |
| $V_{TO}$              | Threshold voltage   | $T_j = 150 \text{ } ^\circ\text{C}$ | Max. | 0.85  |               |
| $R_D$                 | Dynamic resistance  | $T_j = 150 \text{ } ^\circ\text{C}$ | Max. | 9     | m $\Omega$    |
| $I_{DRM}$ , $I_{RRM}$ | $V_D = V_{DRM} = V_{RRM}$                                   | $T_j = 25 \text{ } ^\circ\text{C}$  | Max. | 10    | $\mu\text{A}$ |
|                       |   | $T_j = 150 \text{ } ^\circ\text{C}$ |      | 6     | mA            |

Table 5: Thermal parameters

| Symbol        | Parameter                |      | Value | Unit               |
|---------------|--------------------------|------|-------|--------------------|
| $R_{th(j-c)}$ | Junction to case (DC)    | Max. | 0.6   | $^\circ\text{C/W}$ |
| $R_{th(j-a)}$ | Junction to ambient (DC) | Typ. | 60    |                    |

### 1.1 Characteristics (curves)

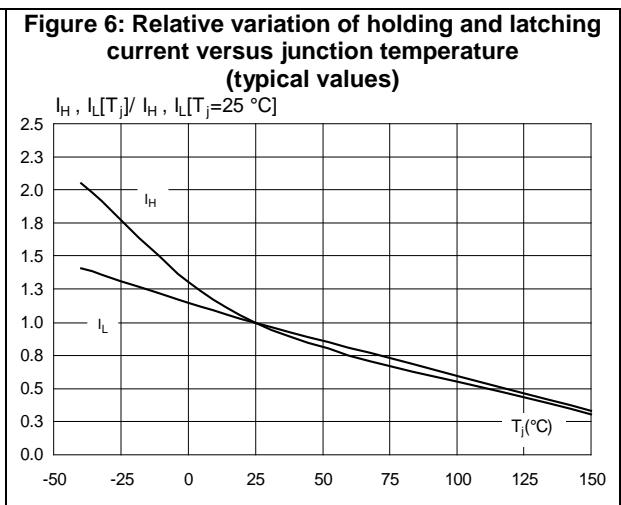
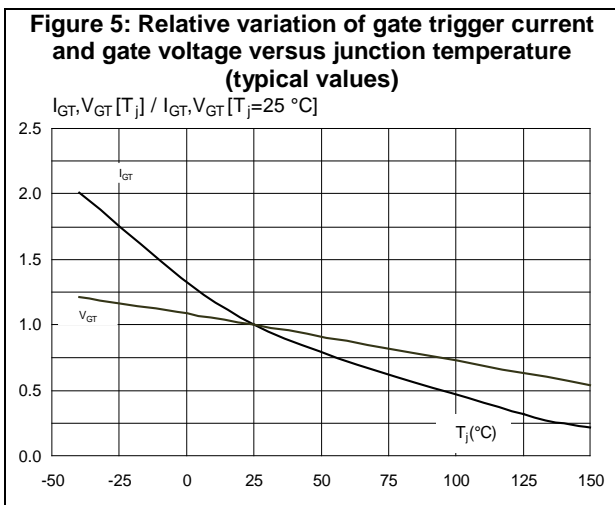
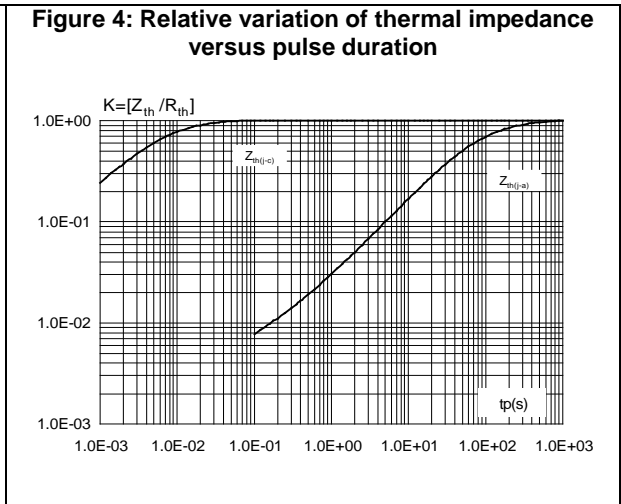
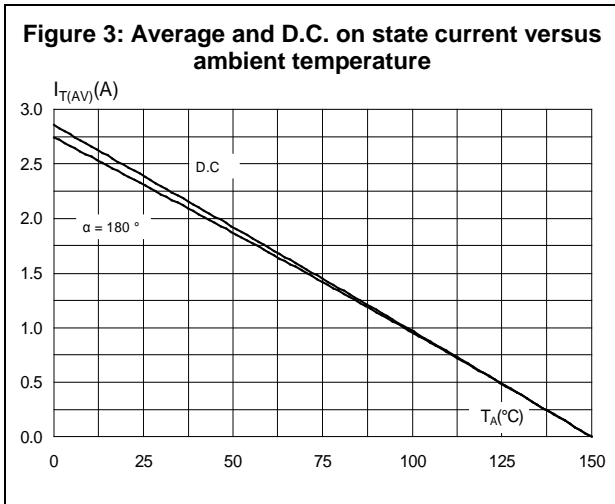
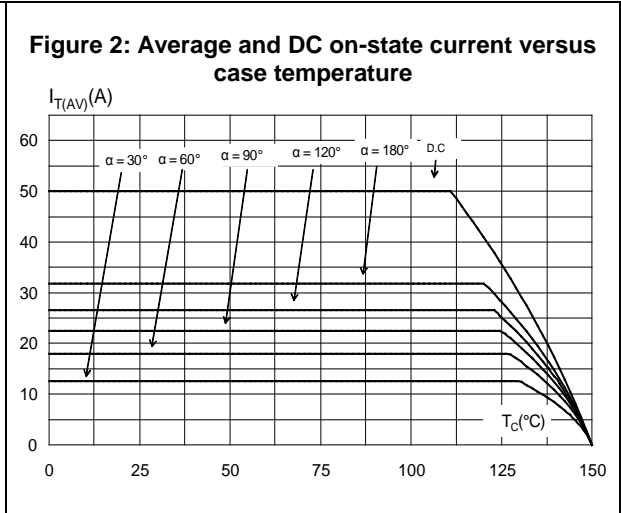
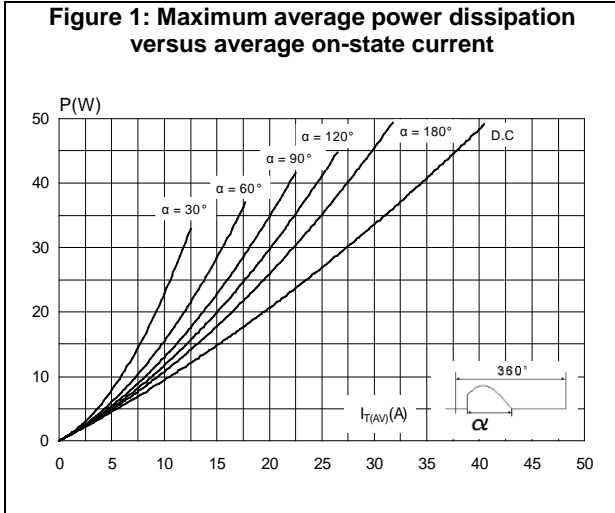

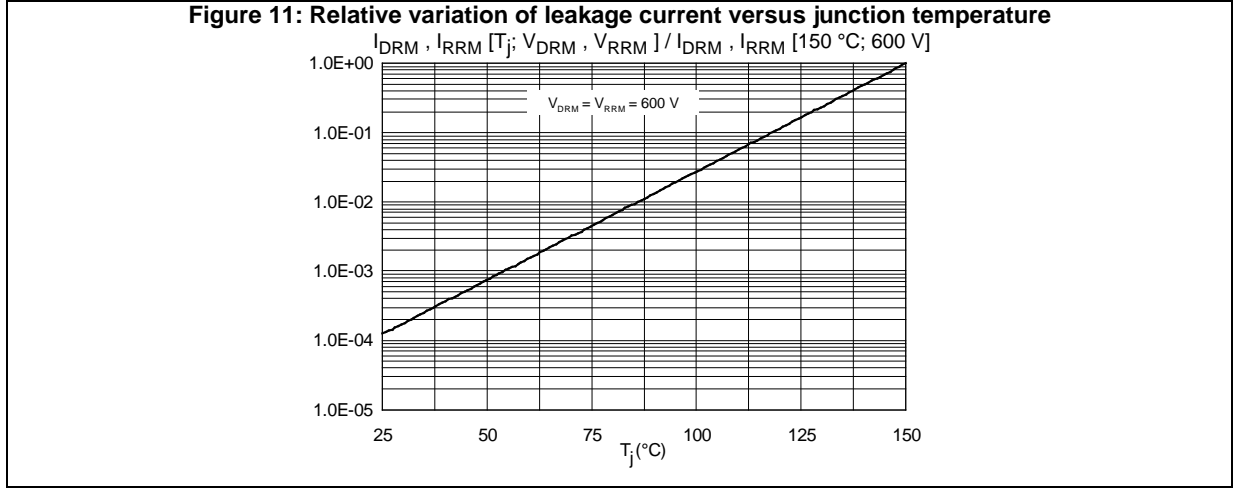
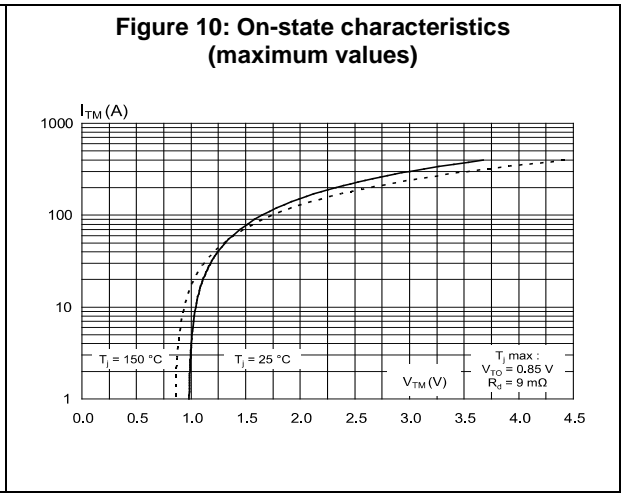
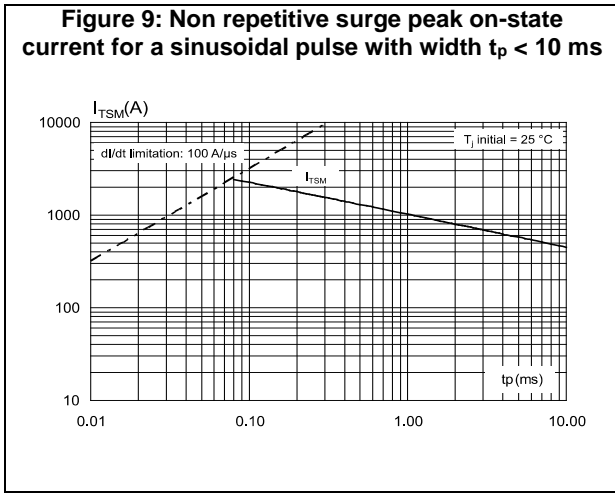
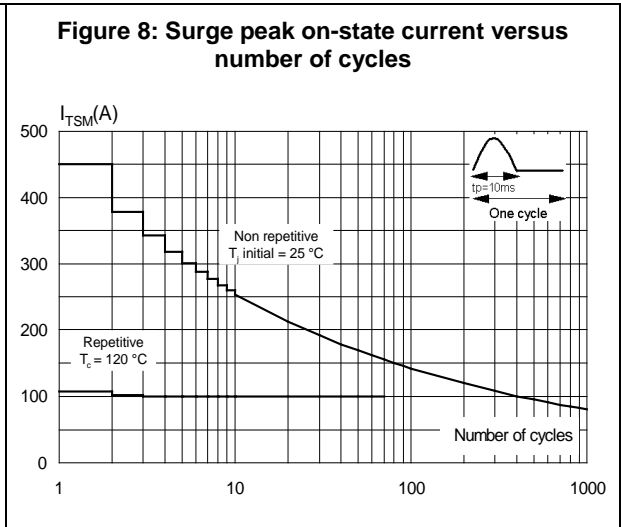
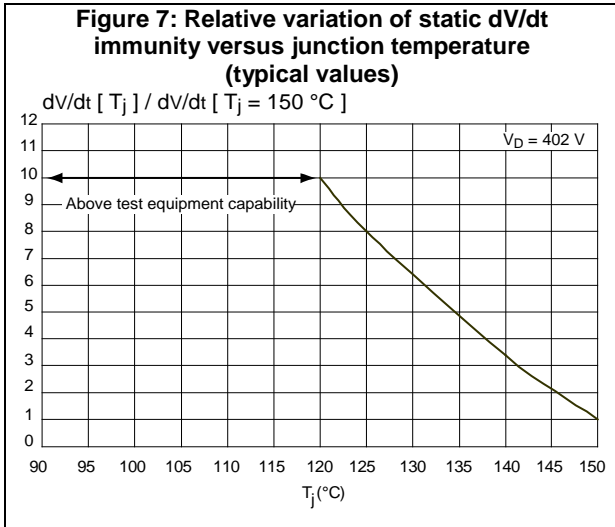

## 2 Package information

In order to meet environmental requirements, ST offers these devices in different grades of ECOPACK® packages, depending on their level of environmental compliance. ECOPACK® specifications, grade definitions and product status are available at: [www.st.com](http://www.st.com). ECOPACK® is an ST trademark.

- Epoxy meets UL94, V0
- Lead-free, halogen-free package

### 2.1 TO-220AB package information

Figure 12: TO-220AB (Nlns. & Ins.) package outline

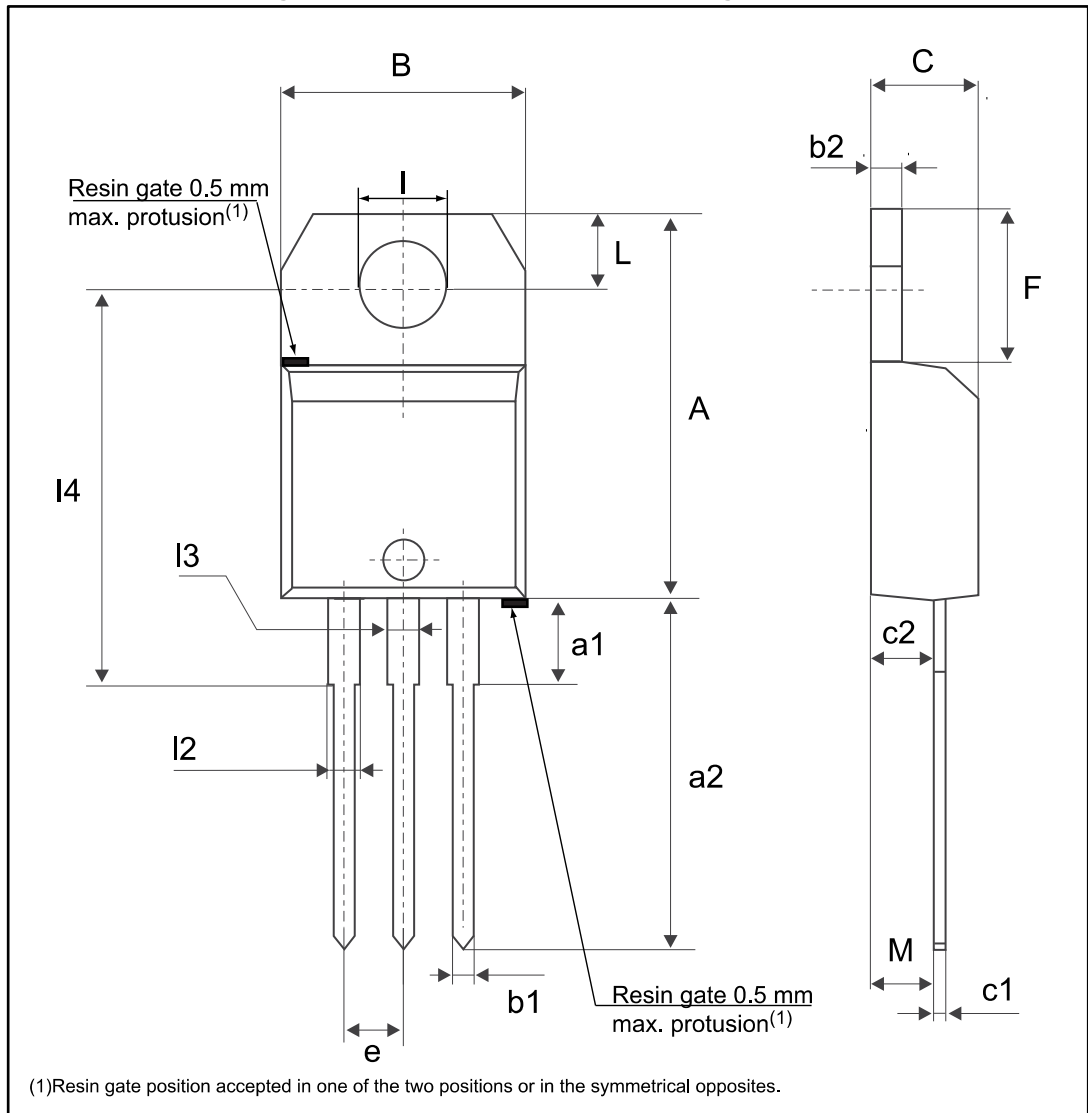

Table 6: TO-220AB (NIns. &amp; Ins.) package mechanical data

| Ref. | Dimensions  |       |       |                       |        |        |
|------|-------------|-------|-------|-----------------------|--------|--------|
|      | Millimeters |       |       | Inches <sup>(1)</sup> |        |        |
|      | Min.        | Typ.  | Max.  | Min.                  | Typ.   | Max.   |
| A    | 15.20       |       | 15.90 | 0.5984                |        | 0.6260 |
| a1   |             | 3.75  |       |                       | 0.1476 |        |
| a2   | 13.00       |       | 14.00 | 0.5118                |        | 0.5512 |
| B    | 10.00       |       | 10.40 | 0.3937                |        | 0.4094 |
| b1   | 0.61        |       | 0.88  | 0.0240                |        | 0.0346 |
| b2   | 1.23        |       | 1.32  | 0.0484                |        | 0.0520 |
| C    | 4.40        |       | 4.60  | 0.1732                |        | 0.1811 |
| c1   | 0.49        |       | 0.70  | 0.0193                |        | 0.0276 |
| c2   | 2.40        |       | 2.72  | 0.0945                |        | 0.1071 |
| e    | 2.40        |       | 2.70  | 0.0945                |        | 0.1063 |
| F    | 6.20        |       | 6.60  | 0.2441                |        | 0.2598 |
| I    | 3.73        |       | 3.88  | 0.1469                |        | 0.1528 |
| L    | 2.65        |       | 2.95  | 0.1043                |        | 0.1161 |
| I2   | 1.14        |       | 1.70  | 0.0449                |        | 0.0669 |
| I3   | 1.14        |       | 1.70  | 0.0449                |        | 0.0669 |
| I4   | 15.80       | 16.40 | 16.80 | 0.6220                | 0.6457 | 0.6614 |
| M    |             | 2.6   |       |                       | 0.1024 |        |

**Notes:**

<sup>(1)</sup>Inch dimensions are for reference only.

### 3 Ordering information

Figure 13: Ordering information scheme

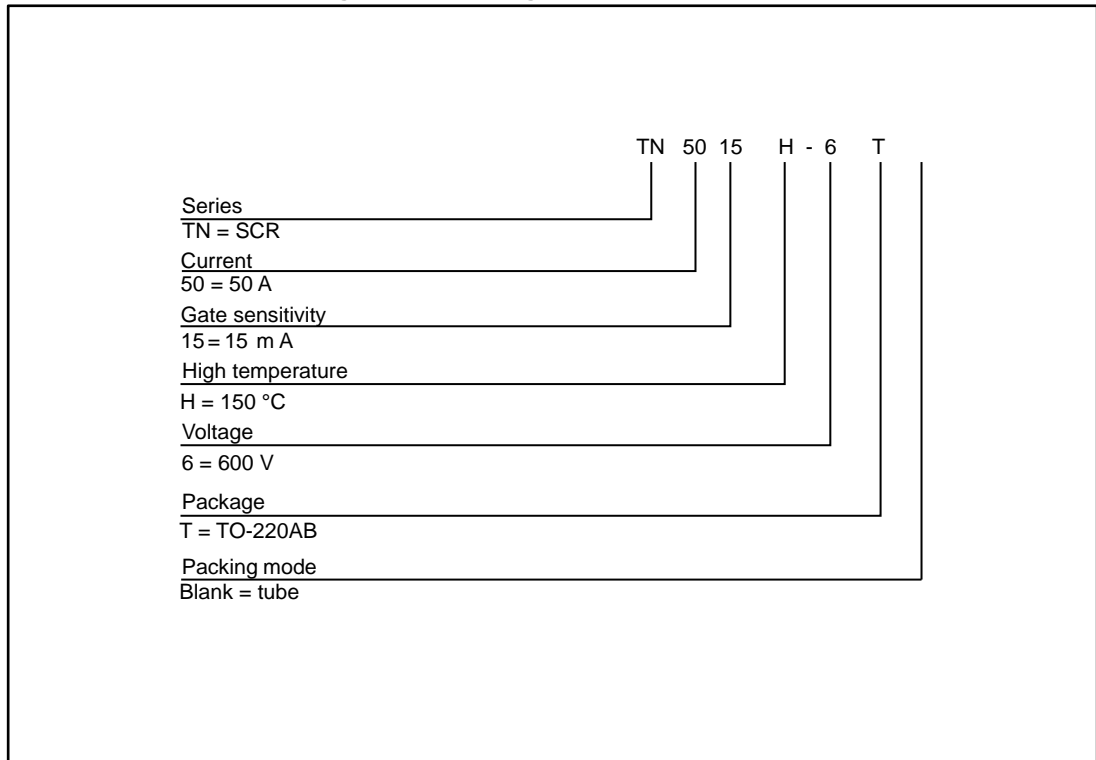

Table 7: Ordering information

| Order code | Marking  | Package  | Weight | Base qty. | Delivery mode |
|------------|----------|----------|--------|-----------|---------------|
| TN5015H-6T | TN5015H6 | TO-220AB | 2.3 g  | 50        | Tube          |

### 4 Revision history

Table 8: Document revision history

| Date        | Revision | Changes          |
|-------------|----------|------------------|
| 01-Jun-2017 | 1        | Initial release. |



**IMPORTANT NOTICE – PLEASE READ CAREFULLY**

STMicroelectronics NV and its subsidiaries ("ST") reserve the right to make changes, corrections, enhancements, modifications, and improvements to ST products and/or to this document at any time without notice. Purchasers should obtain the latest relevant information on ST products before placing orders. ST products are sold pursuant to ST's terms and conditions of sale in place at the time of order acknowledgement.

Purchasers are solely responsible for the choice, selection, and use of ST products and ST assumes no liability for application assistance or the design of Purchasers' products.

No license, express or implied, to any intellectual property right is granted by ST herein.

Resale of ST products with provisions different from the information set forth herein shall void any warranty granted by ST for such product.

ST and the ST logo are trademarks of ST. All other product or service names are the property of their respective owners.

Information in this document supersedes and replaces information previously supplied in any prior versions of this document.

© 2017 STMicroelectronics – All rights reserved