

AHM85 Series



- Medical & IT Safety Approvals
- Energy Star Level V
- CEC 2008 & EISA 2007 Compliant
- IP22 Environmental Rating
- Compact Format 5.90”x 2.52”x 1.45”
- <0.5 W Standby Power
- 85 W – Convection Cooled Ratings
- Class I & Class II Models
- 0 °C to +60 °C Operation
- Very Low Earth Leakage Current
- 3 Year Warranty

The AHM85 series of medical external power supplies is fully approved to international medical safety standards. It has been designed with very high efficiency and low standby power, enabling it to meet the latest environmental legislation. The unit has a fully sealed enclosure complying with IP22 and a smooth surface finish making it easier to wipe down in a clinical setting. With approvals for class I and II the product is suitable for hospital, home healthcare and portable medical device applications.

Models and Ratings - Convection-cooled

Output Power	Output Voltage V1	Max Output Current	Peak ⁽²⁾	Model Number ⁽¹⁾
85 W	12.0 VDC	7.08 A		AHM85PS12
85 W	15.0 VDC	5.67 A		AHM85PS15
85 W	19.0 VDC	4.47 A		AHM85PS19
85 W	24.0 VDC	3.54 A		AHM85PS24
85 W	12.0 VDC	7.08 A		AHM85PS12C2
85 W	15.0 VDC	5.67 A		AHM85PS15C2
85 W	19.0 VDC	4.47 A		AHM85PS19C2
85 W	24.0 VDC	3.54 A		AHM85PS24C2

- Notes:**
1. Models with suffix 'C2' have a Class II equipment protection classification.
 2. For optional input connector retention clip, add suffix '-A' to the model number e.g. AHM85PS24C2-A.

Input Characteristics

Characteristic	Minimum	Typical	Maximum	Units	Notes & Conditions
Input Voltage - Operating	80	115/230	264	VAC	Full power 90 VAC to 264 VAC. Derate output power linearly by 20% from 90 VAC to 80 VAC.
Input Frequency	47	50/60	63	Hz	
Power Factor		>0.9			EN61000-3-2 class A & D compliant & Energy Star Compliant
Input Current - No Load		0.05/0.09		A	115/230 VAC
Input Current - Full Load		0.8/0.4		A	115/230 VAC
Inrush Current		60-80	120	A	230 VAC cold start, 25 °C
No Load Input Power		0.3/0.4	0.5	W	115/230 VAC
Earth Leakage Current		50/85	180	µA	115 V 60 Hz/230 V 50 Hz (Typ.), 264 VAC/60 Hz (Max.)
		0.3/0.6		mA	115/230 VAC/400 Hz
Input Protection	T2.5A/250 V internal fuse in both lines				

Output Characteristics

Characteristic	Minimum	Typical	Maximum	Units	Notes & Conditions
Output Voltage - V1	12		48	VDC	See Models and Ratings table
Output Voltage Adjustment				%	No user adjustment
Minimum Load	0			A	
Start Up Delay		200/100		ms	115/230 VAC full load (see fig.1)
Hold Up Time		15		ms	115/230 VAC full load (see fig.2)
Drift			±0.2	%	After 20 min warm up
Line Regulation			±0.5	%	90-264 VAC (50% load)
Load Regulation			±3	%	0←50→100% load.
Transient Response - V1			5	%	Recovery within 1% in less than 500 µs for a 50-75% and 75-50% load step
Over/Undershoot - V1		3		%	
Ripple & Noise		<1	1.5	% pk-pk	20 MHz bandwidth with external circuit (see fig.3-6)
Overvoltage Protection		125		%	Vnom, Recycle AC to reset
	13.2		18	VDC	AHM85PS12 & C2
	16.5		22		AHM85PS15 & C2
	21.0		28		AHM85PS19 & C2
26.4		33	AHM85PS24 & C2		
Overload Protection	115.0		175	%	I nom, Auto reset
	8.5		12.0	A	AHM85PS12 & C2
	6.8		9.6		AHM85PS15 & C2
	4.9		7.6		AHM85PS19 & C2
4.2		6.0	AHM85PS24 & C2		
Short Circuit Protection					Continuous, trip & restart (hiccup mode)
Temperature Coefficient			0.05	%/°C	
Overtemperature Protection				°C	Connected to transformer. Auto reset.

Start Up Delay From AC Turn On

Figure 1
Start up example from AC turn on
(230 VAC, 79 ms)

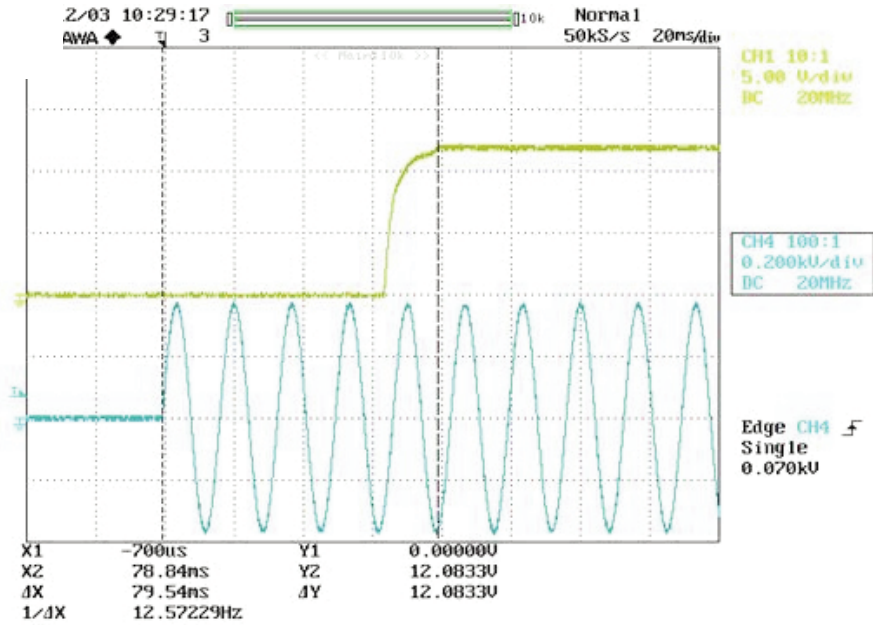

Hold Up Time From Loss of AC

Figure 2
Hold up example at 85 W load
with 230 VAC input (19 ms)

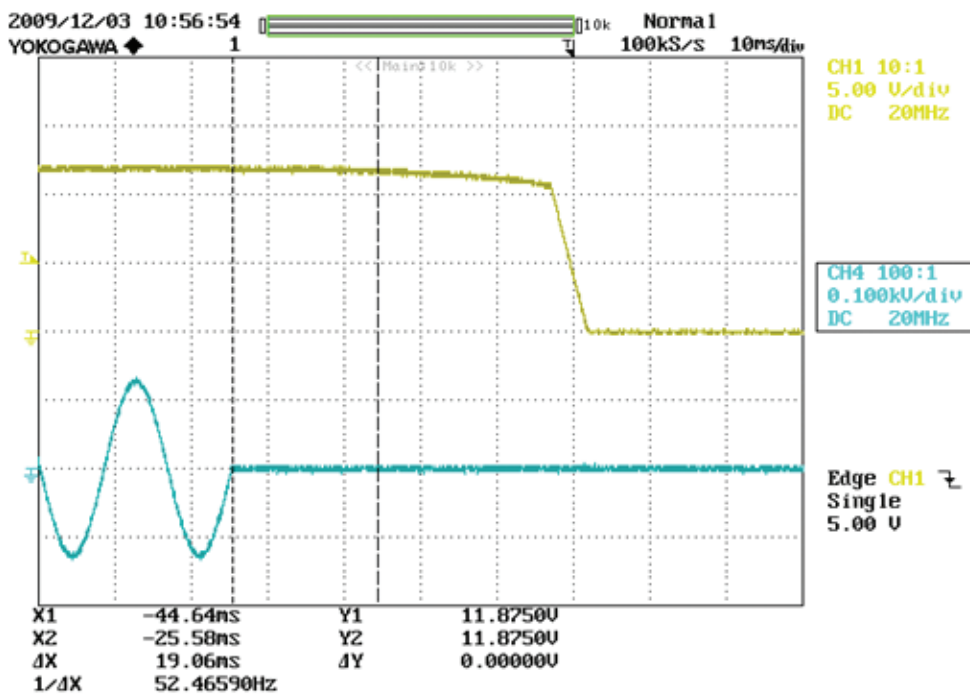

Ripple & Noise

Figure 3
AHM85PS12
Ripple & noise example at 85 W load
with 230 VAC input (75 mV)

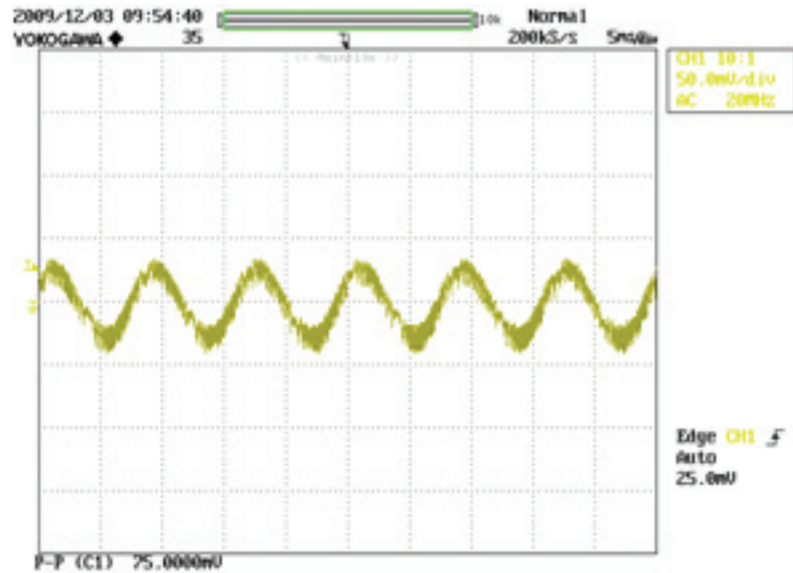

Figure 4
AHM85PS24
Ripple & noise example at 85 W load
with 230 VAC input (77 mV)

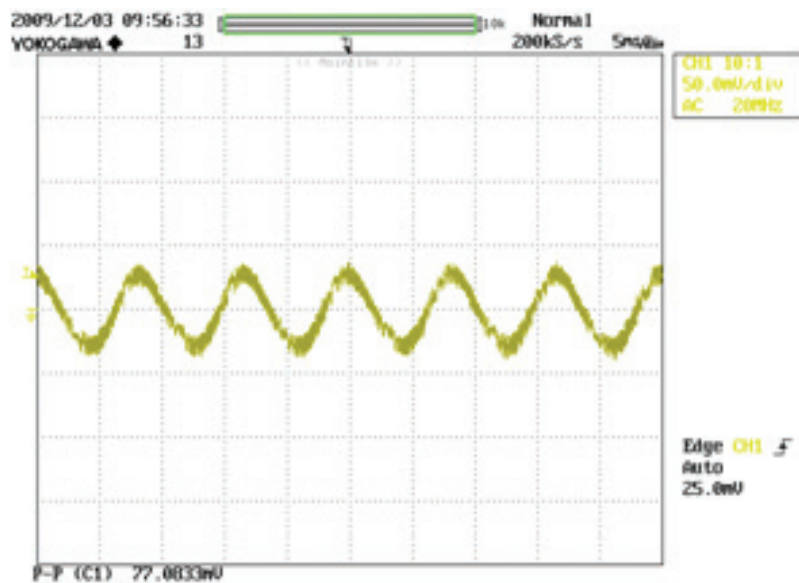
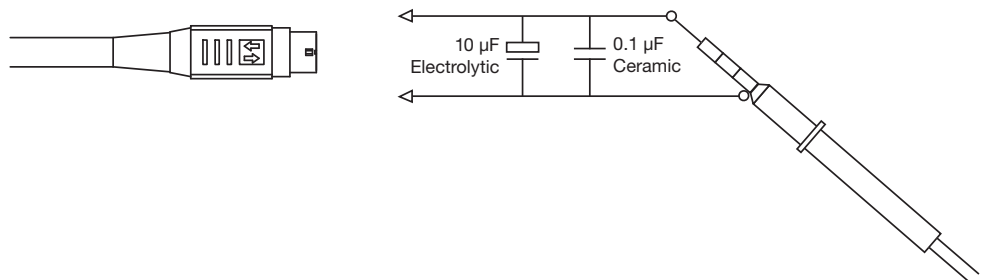

Figure 6
Ripple & noise measurement circuit



General Specifications

Characteristic	Minimum	Typical	Maximum	Units	Notes & Conditions
Efficiency		92		%	Full load (see fig.7-8)
Isolation: Input to Output Input to Ground Output to Ground	4000			VAC	
	1500			VAC	Class I Models
	500			VAC	Class I Models
Switching Frequency	45		200	kHz	PFC stage
	90		110		DC-DC stage
Power Density			3.9	W/in ³	
Mean Time Between Failure		172		kHrs	MIL-HDBK-217F, Notice 2 +25 °C GB
Weight		0.9 (400)		lb (g)	

Average Active Efficiency



Characteristic	Average Active Efficiency		Units	Notes & Conditions
	115 V / 60 Hz	230 VAC / 50 Hz		
AHM85PS12 & C2	90.41	89.92	%	As per Energy Star Level V test procedure
AHM85PS15 & C2	89.37	88.99		
AHM85PS19 & C2	90.36	89.93		
AHM85PS24 & C2	91.67	91.23		

Efficiency Versus Load

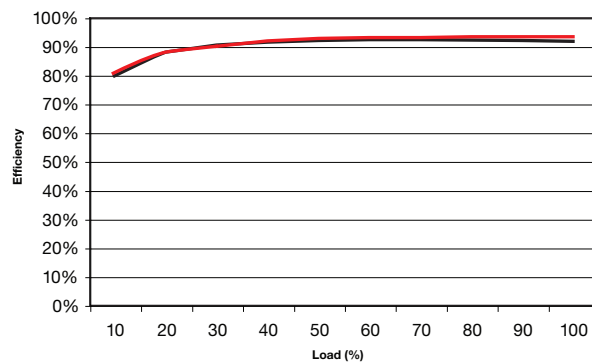

Figure 7 - AHM85PS12

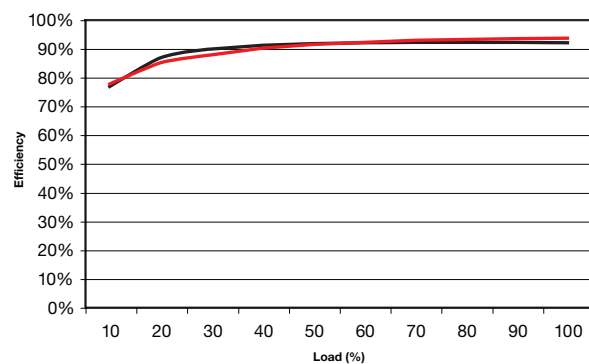
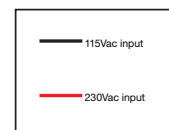

Figure 8 - AHM85PS24



Environmental

Characteristic	Minimum	Typical	Maximum	Units	Notes & Conditions
Operating Temperature	0		+60	°C	Derate linearly to 60% load at 60 °C from +40 °C. (See fig.9)
Case Temperature (IEC60601 3rd Edition)			71	°C	100% Load, with TAMB +40 °C
			60		90% Load Maximum, with TAMB +40 °C
			48		10% Load Maximum, with TAMB +40 °C
Storage Temperature	-40		+85	°C	
Cooling					Convection cooled, see fig.9
Humidity	5		95	%RH	Non-condensing
Operating Altitude			3000	m	
Ingress Protection	IP22				
Shock					3 x 30 g/11 ms shocks in both +ve & -ve directions along the 3 orthogonal axis, total 18 shocks.
Vibration					Three axis 5-500 Hz at 2 g x 10 sweeps

Derating Curve

Figure 9

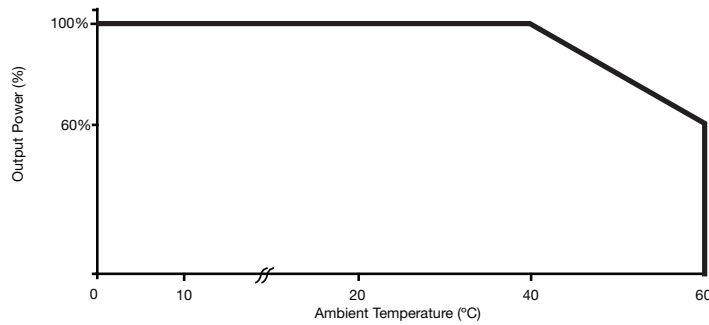

Electromagnetic Compatibility - Immunity

Phenomenon	Standard	Test Level	Criteria	Notes & Conditions
Low Voltage PSU EMC	EN61204-3	High severity level	as below	
Harmonic Current	EN61000-3-2	Class A		
ESD	EN61000-4-2	3	A	
Radiated	EN61000-4-3	3	A	
EFT	EN61000-4-4	3	A	
Surges	EN61000-4-5	Installation class 3	A	
Conducted	EN61000-4-6	3	A	
Magnetic Field	EN61000-4-8	3	A	
Dips and Interruptions	EN61000-4-11	Dip: 30% 500 ms	A	
		Dip: 60% 200 ms	B	
		Dip: 80% 5000 ms	A	
		Dip: 100% 5000 ms	B	
	EN60601-1-2	Dip: 30% 25 AC Cycles	A	230 VAC 100% load, 100 VAC 80% load
		Dip: 60% 5 AC Cycles	A	230 VAC 100% load, 100 VAC 15% load
		Dip: 100% 0.5 AC Cycles	A	
		Int.: >95% 5000 ms	B	

Electromagnetic Compatibility - Emissions

Phenomenon	Standard	Test Level	Criteria	Notes & Conditions
Conducted	EN55011/22	Class B		
Radiated	EN55011/22	Class B		
Voltage Fluctuations	EN61000-3-3			

Safety Agency Approvals

Safety Agency	Safety Standard	Category
CB Report	Certificate # US/15675/UL, IEC60950-1:2005 Ed 2	Information Technology
UL	UL File # E139109-A57-UL-1, UL60950-1 Ed 2 (2007), CSA 22.2 No.60950-1-07 Ed 2	Information Technology
TUV	TUV Certificate # Z1A 10 12 57396 085, EN60950-1:2006	Information Technology
Denan Japan	PSE Certificate	
CE	LVD	

Safety Agency	Safety Standard	Category
CB Report	Certificate #US/16953/UL, IEC60601-1 Ed 3 Including Risk Management	Medical
UL	UL File # E146893-V1-S8, ANSI/AAMI ES 60601-1:2005 & CSA C22.2 No. 60601-1:08	Medical
TUV	TUV Certificate # B11 06 57396 102, EN60601-1:2006	Medical

Means of Protection		Category
Primary to Secondary	2 x MOPP (Means of Patient Protection)	IEC60601-1 Ed 3
Primary to Earth	1 x MOPP (Means of Patient Protection)	
Secondary to Earth	1 x MOPP (Means of Patient Protection)	

Equipment Protection Class	Safety Standard	Notes & Conditions
Class I & Class II	IEC60950-1:2005 Ed 2 & IEC60601-1 Ed 3	See safety agency conditions of acceptability for details

Environmental Legislation

Authority	Location	Date	Notes & Conditions
EISA	US	2007	
CEC	California, US	2008	
Energy Star	US	2008	Level V
ErP Directive	Europe	2011	Regulation No. 278/2009

Mechanical Details

Weight: 0.9 lbs (400 g)
 Dimensions shown in inches (mm).

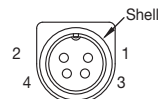
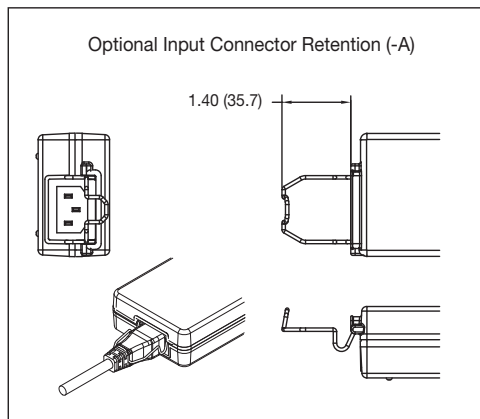
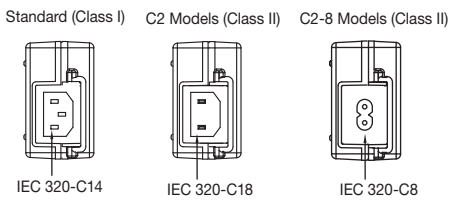
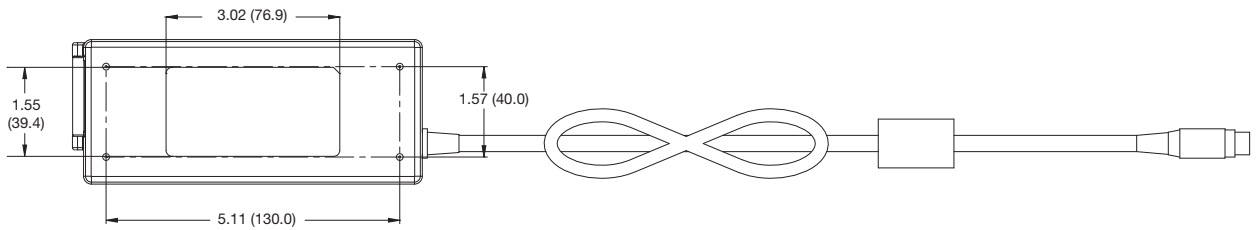
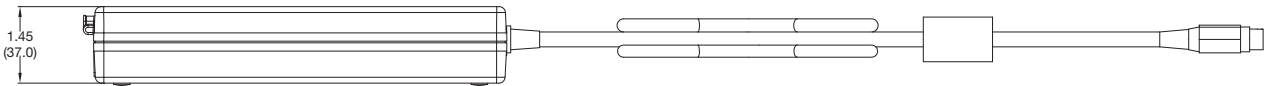
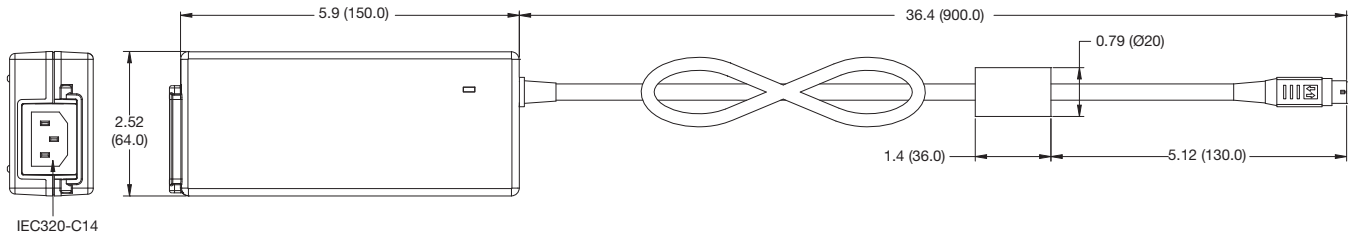

Output Connector equivalent to KPPX-4P (Non Locking)	
Pin 1	Output +
Pin 2	Output +
Pin 3	Return
Pin 4	Return
Outer Shell	GND*
Outer Shell C2 Models	Floating

* Functional earth.

AHM100 Series



- Medical & IT Safety Approvals
- Energy Star Level V
- CEC 2008 & EISA 2007 Compliant
- IP22 Environmental Rating
- Compact Format 6.50" x 2.52" x 1.46"
- <0.5 W Standby Power
- 100 W – Convection Cooled Ratings
- Class I & Class II Models
- 0 °C to +60 °C Operation
- Very Low Earth Leakage Current
- 3 Year Warranty

The AHM100 series of medical external power supplies is fully approved to international medical safety standards. It has been designed with very high efficiency and low standby power, enabling it to meet the latest environmental legislation. The unit has a fully sealed enclosure complying with IP22 and a smooth surface finish making it easier to wipe down in a clinical setting. With approvals for class I and II the product is suitable for hospital, home healthcare and portable medical device applications.

Models and Ratings - Convection-cooled

Output Power	Output Voltage V1	Max Output Current	Peak ⁽³⁾	Model Number ⁽¹⁾
100 W	12.0 VDC	8.33 A		AHM100PS12
100 W	15.0 VDC	6.67 A		AHM100PS15
100 W	19.0 VDC	5.26 A		AHM100PS19
90 W	24.0 VDC	3.75 A	7 A	AHM100PS24P ⁽³⁾
100 W	24.0 VDC	4.16 A		AHM100PS24
100 W	48.0 VDC	2.08 A		AHM100PS48
100 W	12.0 VDC	8.33 A		AHM100PS12C2
100 W	15.0 VDC	6.67 A		AHM100PS15C2
100 W	19.0 VDC	5.26 A		AHM100PS19C2
90 W	24.0 VDC	3.75 A	7 A	AHM100PS24C2P ⁽³⁾
100 W	24.0 VDC	4.16 A		AHM100PS24C2
100 W	48.0 VDC	2.08 A		AHM100PS48C2

- Notes:**
1. Models with suffix 'C2' have a Class II equipment protection classification.
 2. Maximum peak duration 300 ms, average power must not exceed 90 W.
 3. Peak models are not standard product. Contact sales for details and availability.
 4. For optional input connector retention clip, add suffix '-A' to the model number e.g. AHM100PS24C2-A.

Input Characteristics

Characteristic	Minimum	Typical	Maximum	Units	Notes & Conditions
Input Voltage - Operating	80	115/230	264	VAC	Full power 90 VAC to 264 VAC. Derate output power linearly by 20% from 90 VAC to 80 VAC.
Input Frequency	47	50/60	63	Hz	
Power Factor		>0.9			EN61000-3-2 class A & D compliant & Energy Star Compliant
Input Current - No Load		0.05/0.09		A	115/230 VAC
Input Current - Full Load		1.0/0.5		A	115/230 VAC
Inrush Current		60-80	120	A	230 VAC cold start, 25 °C
No Load Input Power		0.3/0.4	0.5	W	115/230 VAC
Earth Leakage Current		50/85	180	µA	115 V 60 Hz/230 V 50 Hz (Typ.), 264 VAC/60 Hz (Max.)
		0.3/0.6		mA	115/230 VAC/400 Hz
Input Protection	T2.5A/250 V internal fuse in both lines				

Output Characteristics

Characteristic	Minimum	Typical	Maximum	Units	Notes & Conditions
Output Voltage - V1	12		48	VDC	See Models and Ratings table
Output Voltage Adjustment				%	No user adjustment
Minimum Load	0			A	
Start Up Delay		200/100		ms	115/230 VAC full load (see fig.1)
Hold Up Time		20		ms	115/230 VAC full load (see fig.2)
Drift			±0.2	%	After 20 min warm up
Line Regulation			±0.5	%	90-264 VAC (50% load)
Load Regulation			±3	%	0←50→100% load.
Transient Response - V1			5	%	Recovery within 1% in less than 500 µs for a 50-75% and 75-50% load step
Over/Undershoot - V1		3		%	
Ripple & Noise		<1	1.5	% pk-pk	20 MHz bandwidth with external circuit (see fig.3-6)
Overvoltage Protection		125		%	Vnom, Recycle AC to reset
		13.2	18	VDC	AHM100PS12 & C2
		16.5	22		AHM100PS15 & C2
		21.0	28		AHM100PS19 & C2
		26.4	33		AHM100PS24 & C2
	52.8	59	AHM100PS48 & C2		
Overload Protection		115.0	175	%	I nom, Auto reset
		10.0	14.0	A	AHM100PS12 & C2
		8.0	11.4		AHM100PS15 & C2
		6.3	9.0		AHM100PS19 & C2
		5.0	7.1		AHM100PS24 & C2
	2.5	3.6	AHM100PS48 & C2		
Short Circuit Protection					Continuous, trip & restart (hiccup mode)
Temperature Coefficient			0.05	%/°C	
Overtemperature Protection				°C	Connected to transformer. Auto reset.

Start Up Delay From AC Turn On

Figure 1
Start up example from AC turn on
(230 VAC, 95 ms)

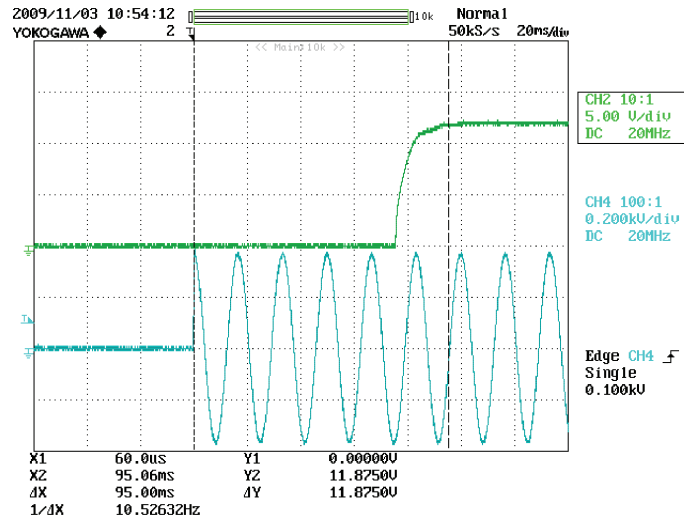

Hold Up Time From Loss of AC

Figure 2
Hold up example at 100 W load
with 230 VAC input (25 ms)

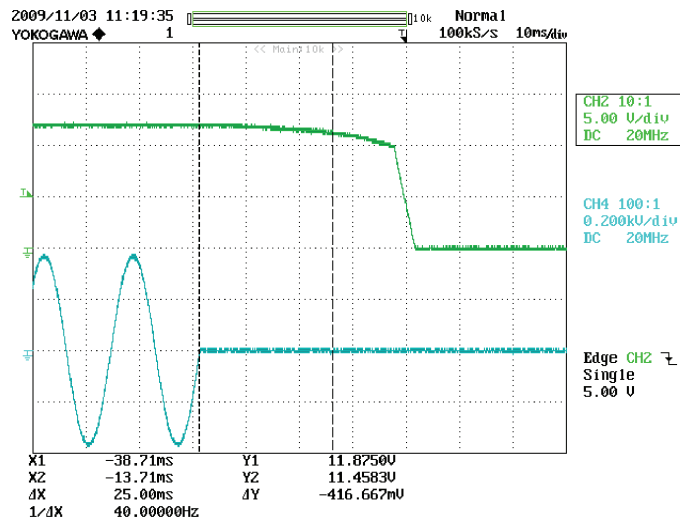

Ripple & Noise

Figure 3
AHM100PS12
Ripple & noise example at 100 W load
with 230 VAC input (58 mV)

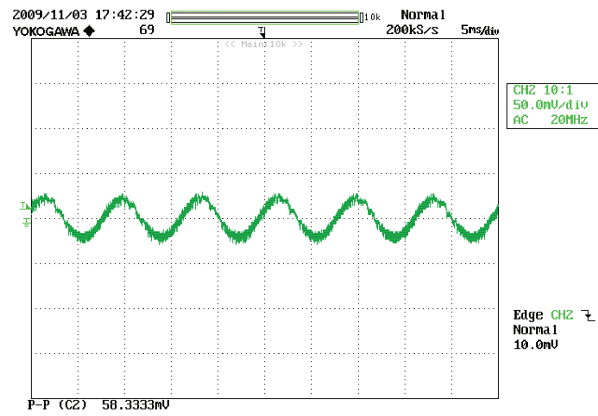

Figure 4
AHM100PS24
Ripple & noise example at 100 W load
with 230 VAC input (258 mV)

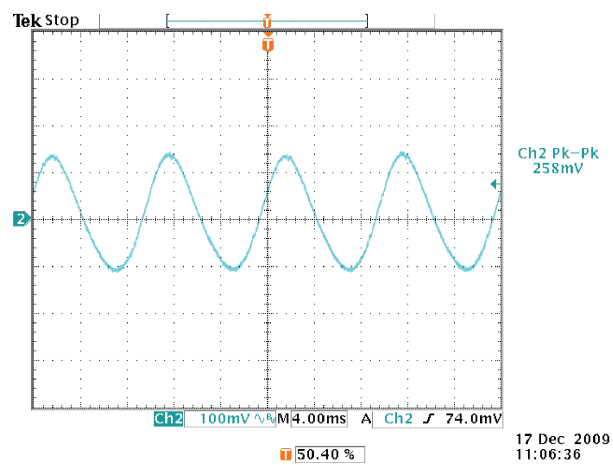

Figure 5
AHM100PS48
Ripple & noise example at 100 W load
with 230 VAC input (318 mV)

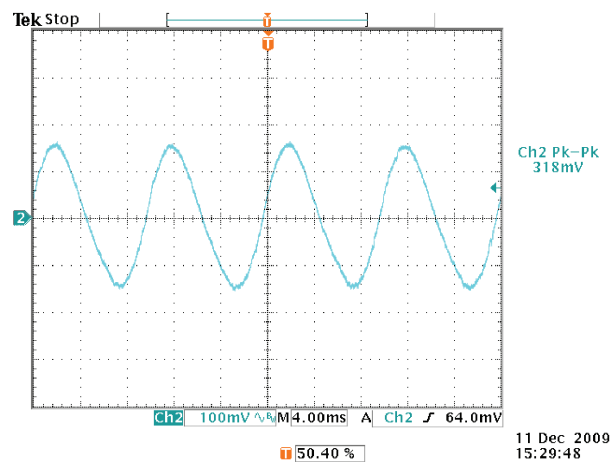
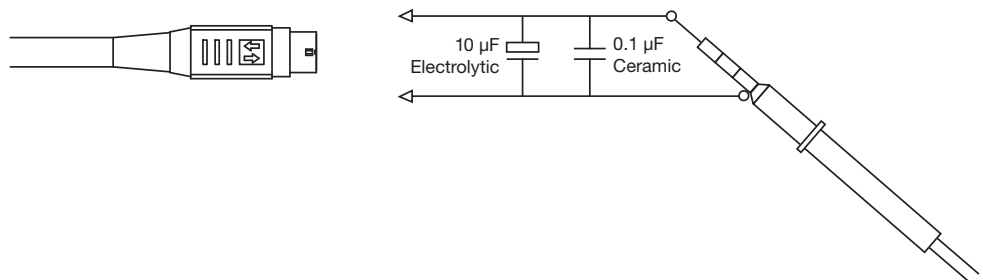

Figure 6
Ripple & noise measurement circuit



General Specifications

Characteristic	Minimum	Typical	Maximum	Units	Notes & Conditions
Efficiency		92		%	Full load (see fig.7-9)
Isolation: Input to Output Input to Ground Output to Ground	4000			VAC	
	1500			VAC	Class I Models
	500			VAC	Class I Models
Switching Frequency	45		200	kHz	PFC stage
	90		110		DC-DC stage
Power Density			4.4	W/in ³	
Mean Time Between Failure		153		kHrs	MIL-HDBK-217F, Notice 2 +25 °C GB
Weight		1.1 (500)		lb (g)	

Average Active Efficiency

Characteristic	Average Active Efficiency		Units	Notes & Conditions
	115 V / 60 Hz	230 VAC / 50 Hz		
AHM100PS12 & C2	90.52	90.32	%	As per Energy Star Level V test procedure
AHM100PS15 & C2	89.88	89.64		
AHM100PS19 & C2	89.99	89.74		
AHM100PS24 & C2	91.67	91.43		
AHM100PS48 & C2	91.80	91.63		

Efficiency Versus Load

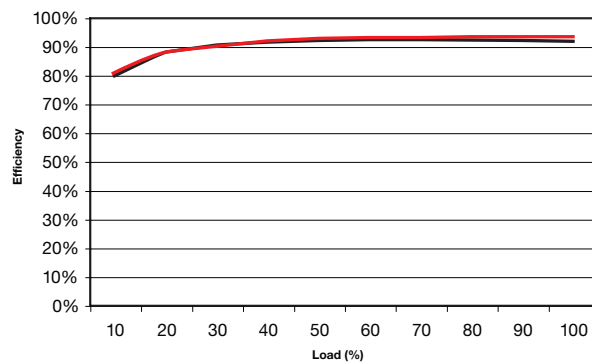

Figure 7 - AHM100PS12

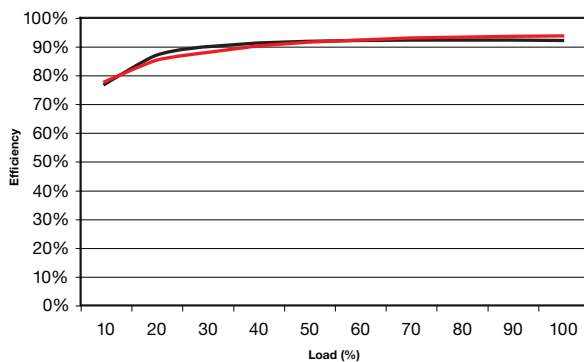

Figure 8 - AHM100PS24

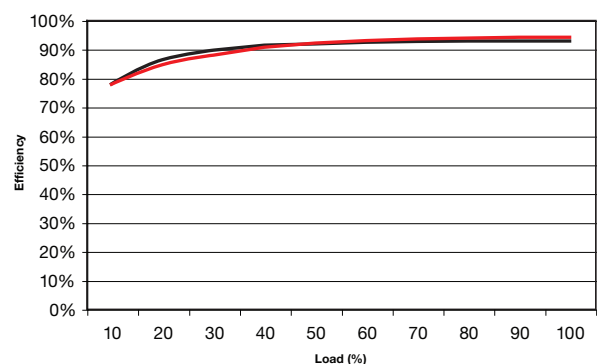
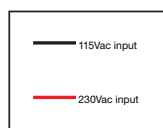

Figure 9 - AHM100PS48



Environmental

Characteristic	Minimum	Typical	Maximum	Units	Notes & Conditions
Operating Temperature	0		+60	°C	Derate linearly to 60% load at 60 °C from +40 °C. (See fig.10)
Case Temperature (IEC60601 3rd Edition)			71	°C	100% Load, with TAMB +40 °C
			60		80% Load Maximum, with TAMB +40 °C
			48		10% Load Maximum, with TAMB +40 °C
Storage Temperature	-40		+85	°C	
Cooling					Convection cooled, see fig.10
Humidity	5		95	%RH	Non-condensing
Operating Altitude			3000	m	
Ingress Protection	IP22				
Shock					3 x 30 g/11 ms shocks in both +ve & -ve directions along the 3 orthogonal axis, total 18 shocks.
Vibration					Three axis 5-500 Hz at 2 g x 10 sweeps

Derating Curve

Figure 10

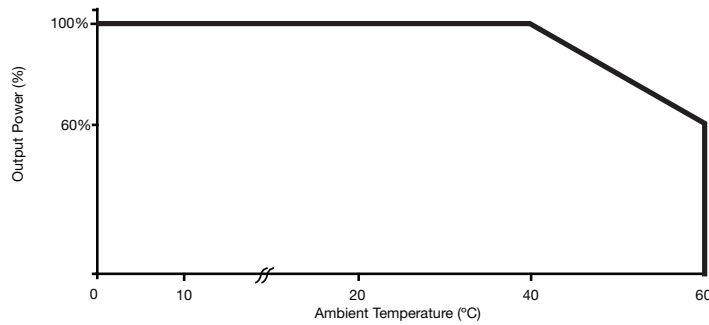

Electromagnetic Compatibility - Immunity

Phenomenon	Standard	Test Level	Criteria	Notes & Conditions
Low Voltage PSU EMC	EN61204-3	High severity level	as below	
Harmonic Current	EN61000-3-2	Class A		
ESD	EN61000-4-2	3	A	
Radiated	EN61000-4-3	3	A	
EFT	EN61000-4-4	3	A	
Surges	EN61000-4-5	Installation class 3	A	
Conducted	EN61000-4-6	3	A	
Magnetic Field	EN61000-4-8	3	A	
Dips and Interruptions	EN61000-4-11	Dip: 30% 500 ms	A	
		Dip: 60% 200 ms	B	
		Dip: 80% 5000 ms	A	
		Dip: 100% 5000 ms	B	
	EN60601-1-2	Dip: 30% 25 AC Cycles	A	230 VAC 100% load, 100 VAC 80% load
		Dip: 60% 5 AC Cycles	A	230 VAC 100% load, 100 VAC 15% load
		Dip: 100% 0.5 AC Cycles	A	
		Int.: >95% 5000 ms	B	

Electromagnetic Compatibility - Emissions

Phenomenon	Standard	Test Level	Criteria	Notes & Conditions
Conducted	EN55011/22	Class B		
Radiated	EN55011/22	Class B		
Voltage Fluctuations	EN61000-3-3			

Safety Agency Approvals

Safety Agency	Safety Standard	Category
CB Report	Certificate # US/15053A/UL, IEC60950-1:2005 Ed 2	Information Technology
UL	UL File # E139109-A45-UL-1, UL60950-1 Ed 2 (2007), CSA 22.2 No.60950-1-07 Ed 2	Information Technology
TUV	TUV Certificate # Z1A 10 07 57396 078, EN60950-1:2006	Information Technology
Denan Japan	PSE Certificate	
CE	LVD	

Safety Agency	Safety Standard	Category
CB Report	Certificate #US/18097/UL, IEC60601-1 Ed 3 Including Risk Management	Medical
UL	UL File # E146893, ANSI/AAMI ES 60601-1:2005 & CSA C22.2 No. 60601-1:08	Medical
TUV	TUV Certificate # Z11 12 57396 122, EN60601-1:2006	Medical

Means of Protection		Category
Primary to Secondary	2 x MOPP (Means of Patient Protection)	IEC60601-1 Ed 3
Primary to Earth	1 x MOPP (Means of Patient Protection)	
Secondary to Earth	1 x MOPP (Means of Patient Protection)	

Equipment Protection Class	Safety Standard	Notes & Conditions
Class I & Class II	IEC60950-1:2005 Ed 2 & IEC60601-1 Ed 3	See safety agency conditions of acceptability for details

Environmental Legislation

Authority	Location	Date	Notes & Conditions
EISA	US	2007	
CEC	California, US	2008	
Energy Star	US	2008	Level V
ErP Directive	Europe	2011	Regulation No. 278/2009

Mechanical Details

Weight: 1.1 lbs (500 g)
 Dimensions shown in inches (mm).

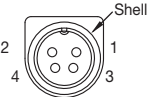
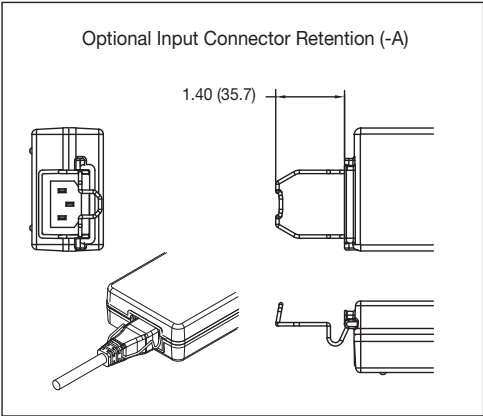
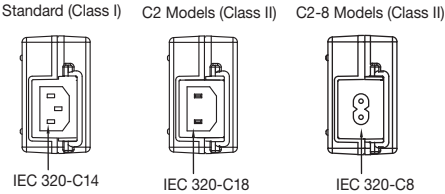
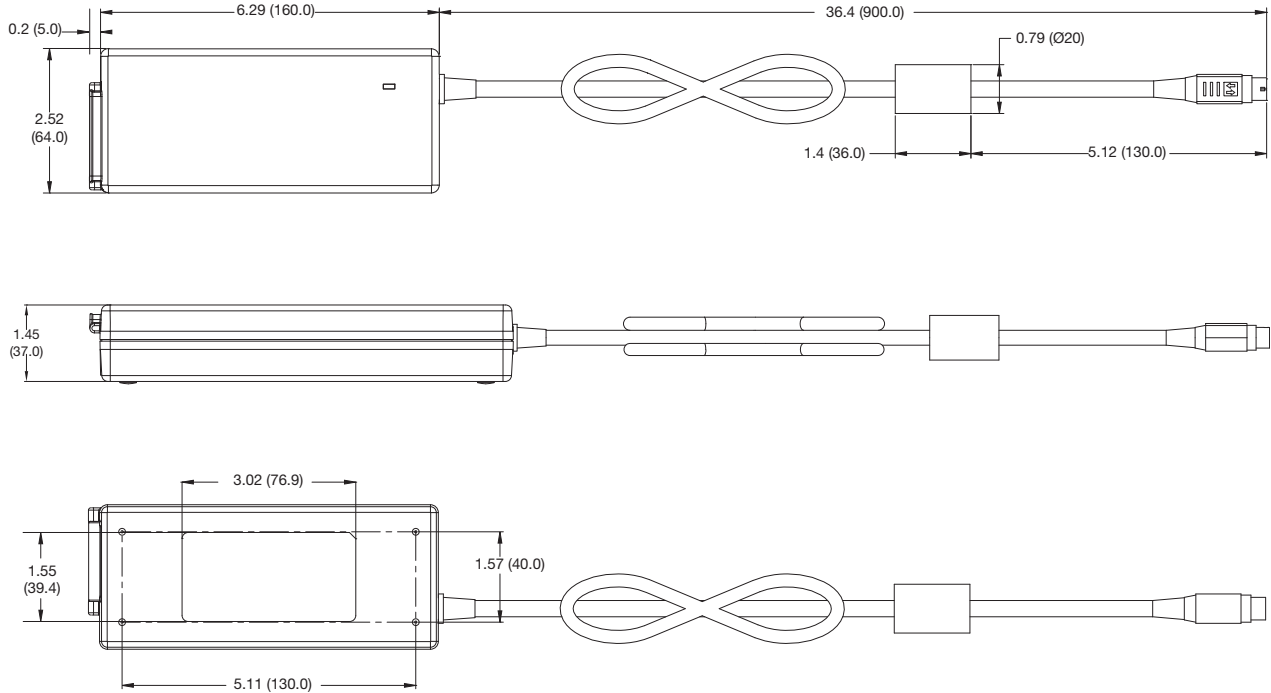

Output Connector equivalent to KPPX-4P (Non Locking)	
Pin 1	Output +
Pin 2	Output +
Pin 3	Return
Pin 4	Return
Outer Shell	GND*
Outer Shell C2 Models	Floating

* Functional earth.

AHM150 Series



- Medical & IT Safety Approvals
- Energy Star Level V
- CEC 2008 & EISA 2007 Compliant
- IP22 Environmental Rating
- Compact Format 7.80" x 3.15" x 1.45"
- <0.5 W Standby Power
- 150 W – Convection Cooled Ratings
- Class I & Class II Models
- 0 °C to +60 °C Operation
- Very Low Earth Leakage Current
- 3 Year Warranty

The AHM150 series of medical external power supplies is fully approved to international medical safety standards. It has been designed with very high efficiency and low standby power, enabling it to meet the latest environmental legislation. The unit has a fully sealed enclosure complying with IP22 and a smooth surface finish making it easier to wipe down in a clinical setting. With both medical & IT approvals in class I and class II formats the product is suitable for hospital, home healthcare, portable medical device applications and a wide range of IT applications.

Models and Ratings - Convection-cooled

Output Power	Output Voltage V1	Max Output Current	Model Number ⁽¹⁾
150 W	12.0 VDC	12.50 A	AHM150PS12
150 W	15.0 VDC	10.00 A	AHM150PS15
150 W	19.0 VDC	7.89 A	AHM150PS19
150 W	24.0 VDC	6.25 A	AHM150PS24
150 W	48.0 VDC	3.13 A	AHM150PS48
150 W	12.0 VDC	12.50 A	AHM150PS12C2
150 W	15.0 VDC	10.00 A	AHM150PS15C2
150 W	19.0 VDC	7.89 A	AHM150PS19C2
150 W	24.0 VDC	6.25 A	AHM150PS24C2
150 W	48.0 VDC	3.13 A	AHM150PS48C2

Notes:

1. For optional input connector retention clip, add suffix 'A' to the model number e.g. AHM150PS24-A. Models with suffix 'C2' have a class II equipment protection classification. For IEC320-C8 input connector with class II models, add suffix '8' to the model number, e.g. AHM150PS24C2-8.

Input Characteristics

Characteristic	Minimum	Typical	Maximum	Units	Notes & Conditions
Input Voltage - Operating	80	115/230	264	VAC	Full power 90 VAC to 264 VAC. Derate output power linearly by 20% from 90 VAC to 80 VAC.
Input Frequency	47	50/60	63	Hz	
Power Factor		>0.9			EN61000-3-2 class A & D compliant & Energy Star Compliant
Input Current - No Load		0.06/0.04		A	115/230 VAC
Input Current - Full Load		1.4/0.7		A	115/230 VAC
Inrush Current		60-80	120	A	230 VAC cold start, 25 °C
No Load Input Power		0.3/0.4	0.5	W	115/230 VAC
Earth Leakage Current		50/100	200	µA	115 V 60 Hz/230 V 50 Hz (Typ.), 264 VAC/60 Hz (Max.)
		0.3/0.6		mA	115/230 VAC/400 Hz
Input Protection	T4.0A/250 V internal fuse in both lines				

Output Characteristics

Characteristic	Minimum	Typical	Maximum	Units	Notes & Conditions
Output Voltage - V1	12		48	VDC	See Models and Ratings table
Output Voltage Adjustment				%	No user adjustment
Minimum Load	0			A	
Start Up Delay		200/100		ms	115/230 VAC full load (see fig.1)
Hold Up Time		10		ms	115/230 VAC full load (see fig.2)
Drift			±0.2	%	After 20 min warm up
Line Regulation			±0.5	%	90-264 VAC (50% load)
Load Regulation			±4	%	0←50→100% load.
Transient Response - V1			5	%	Recovery within 1% in less than 500 µs for a 50-75% and 75-50% load step
Over/Undershoot - V1		3		%	
Ripple & Noise		<1	1.5	% pk-pk	20 MHz bandwidth with external circuit (see fig.3-6)
Overvoltage Protection		125		%	Vnom, Recycle AC to reset
		13.2	18	VDC	AHM150PS12 & C2
		16.5	22		AHM150PS15 & C2
		20.9	28		AHM150PS19 & C2
		26.4	33		AHM150PS24 & C2
	52.8	59	AHM150PS48 & C2		
Overload Protection		115.0	175	%	I nom, Auto reset
		15.0	21.3	A	AHM150PS12 & C2
		12.0	17.0		AHM150PS15 & C2
		8.7	13.4		AHM150PS19 & C2
		6.8	10.6		AHM150PS24 & C2
	3.7	5.3	AHM150PS48 & C2		
Short Circuit Protection					Continuous, trip & restart (hiccup mode)
Temperature Coefficient			0.05	%/°C	
Overtemperature Protection				°C	Connected to transformer. Auto reset.

Start Up Delay From AC Turn On

Figure 1
Start up example from AC turn on
(230 VAC, 196 ms)

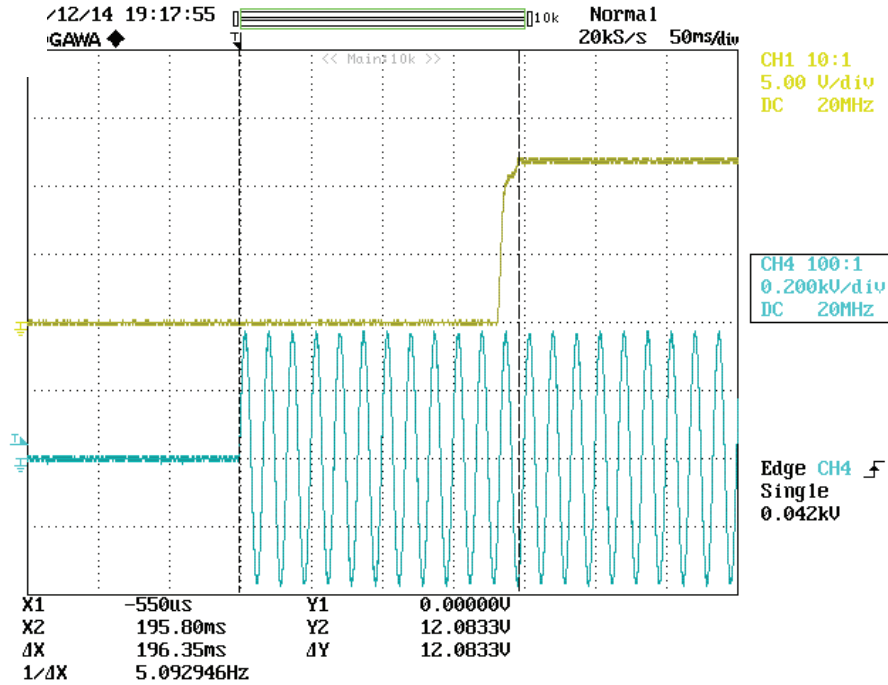

Hold Up Time From Loss of AC

Figure 2
Hold up example at 150 W load
with 230 VAC input (16 ms)

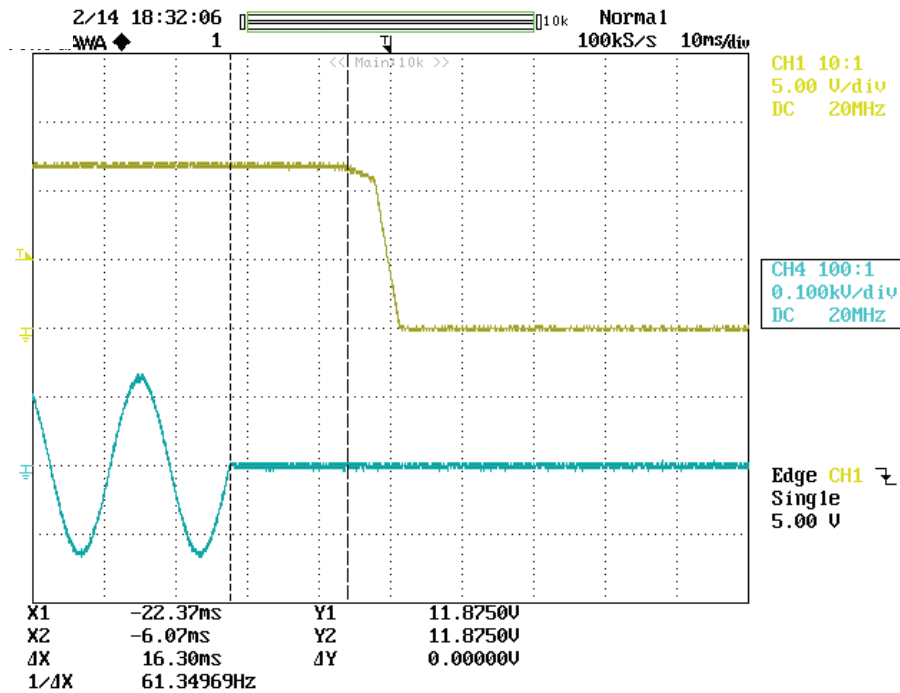

Ripple & Noise

Figure 3
AHM150PS12
Ripple & noise example at 150 W load
with 230 VAC input (60 mV)

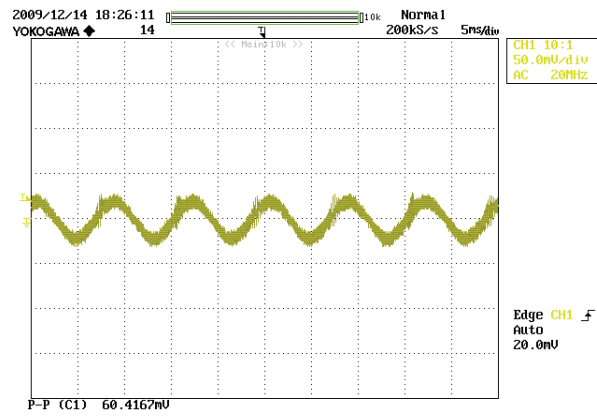

Figure 4
AHM150PS24
Ripple & noise example at 150 W load
with 230 VAC input (137 mV)

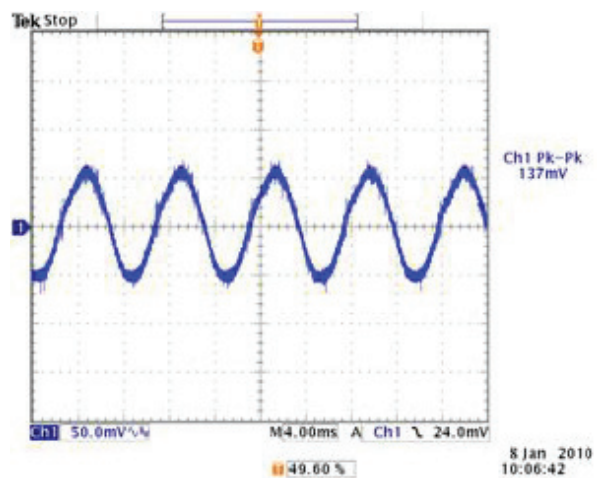

Figure 5
AHM150PS48
Ripple & noise example at 150 W load
with 230 VAC input (296 mV)

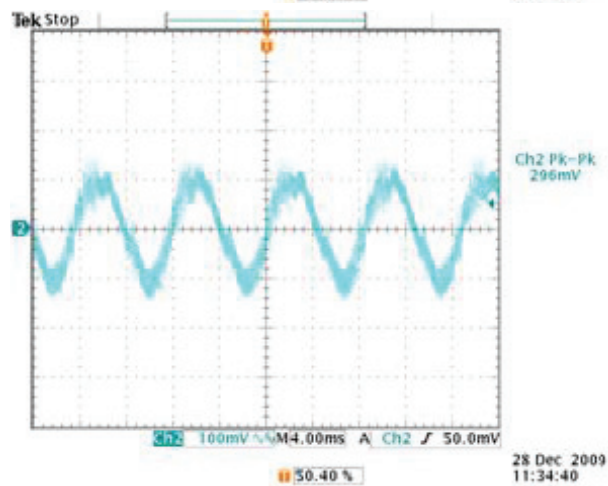
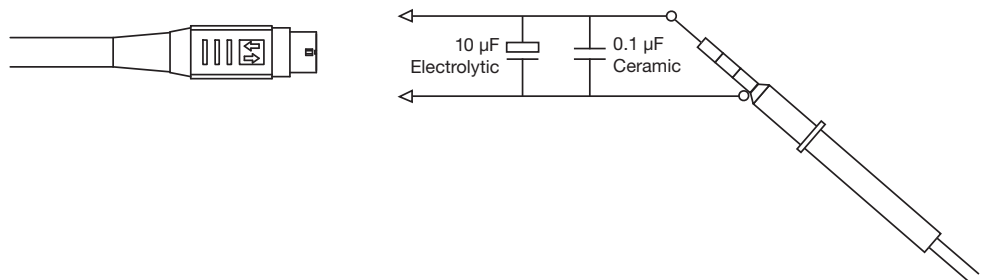

Figure 6
Ripple & noise measurement circuit



General Specifications

Characteristic	Minimum	Typical	Maximum	Units	Notes & Conditions
Efficiency		92		%	Full load (see fig.7-9)
Isolation: Input to Output Input to Ground Output to Ground	4000			VAC	
	1500			VAC	
	500			VAC	
Switching Frequency	30		200	kHz	PFC stage
	90		110		DC-DC stage
Power Density			4.2	W/in ³	
Mean Time Between Failure		163		kHrs	MIL-HDBK-217F, Notice 2 +25 °C GB
Weight		1.3 (600)		lb (g)	

Average Active Efficiency



Characteristic	Average Active Efficiency		Units	Notes & Conditions
	115 V / 60 Hz	230 VAC / 50 Hz		
AHM150PS12	90.31	91.74	%	As per Energy Star Level V test procedure
AHM150PS15	91.44	91.78		
AHM150PS19	92.00	92.52		
AHM150PS24	91.46	92.99		
AHM150PS48	92.38	92.85		

Efficiency Versus Load

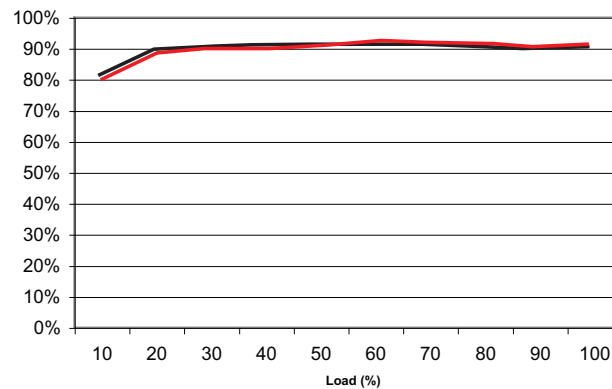

Figure 7 - AHM150PS12

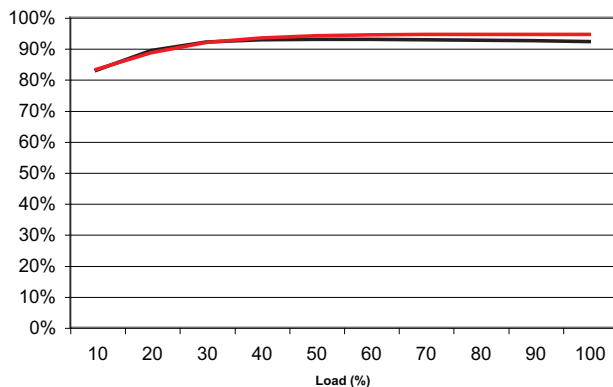

Figure 8 - AHM150PS24

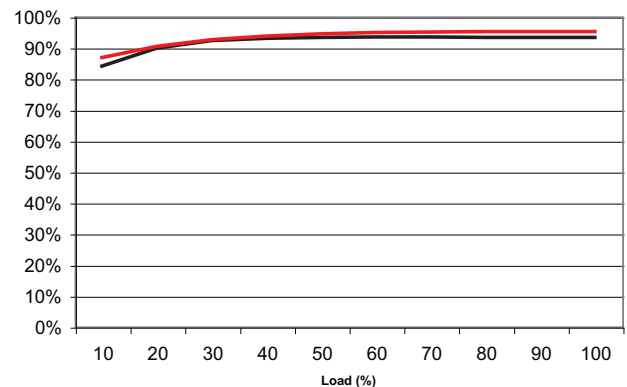
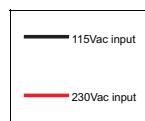

Figure 9 - AHM150PS48



Environmental

Characteristic	Minimum	Typical	Maximum	Units	Notes & Conditions
Operating Temperature	0		+60	°C	Derate linearly to 60% load at 60 °C from +40 °C. (See fig.10)
Case Temperature (IEC60601 3rd Edition)			71	°C	100% Load, with TAMB +40 °C
			60		70% Load Maximum, with TAMB +40 °C
			48		10% Load Maximum, with TAMB +40 °C
Storage Temperature	-40		+85	°C	
Cooling					Convection cooled, see fig.10
Humidity	5		95	%RH	Non-condensing
Operating Altitude			3000	m	
Ingress Protection	IP22				
Shock					3 x 30 g/11 ms shocks in both +ve & -ve directions along the 3 orthogonal axis, total 18 shocks.
Vibration					Three axis 5-500 Hz at 2 g x 10 sweeps

Derating Curve

Figure 10

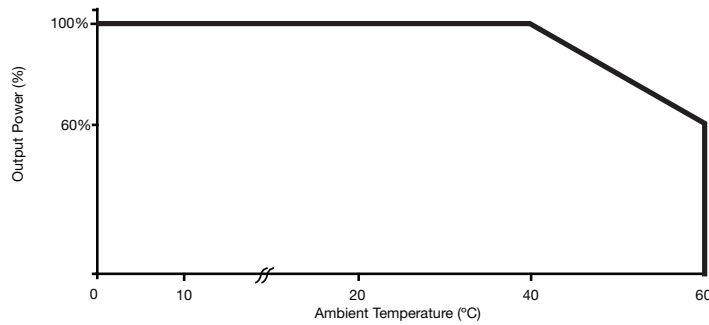

Electromagnetic Compatibility - Immunity

Phenomenon	Standard	Test Level	Criteria	Notes & Conditions
Low Voltage PSU EMC	EN61204-3	High severity level	as below	
Harmonic Current	EN61000-3-2	Class A		
ESD	EN61000-4-2	3	A	
Radiated	EN61000-4-3	3	A	
EFT	EN61000-4-4	3	A	
Surges	EN61000-4-5	Installation class 3	A	
Conducted	EN61000-4-6	3	A	
Magnetic Field	EN61000-4-8	3	A	
Dips and Interruptions	EN61000-4-11	Dip: 30% 500 ms	A	
		Dip: 60% 200 ms	B	
		Dip: 80% 5000 ms	A	
		Dip: 100% 5000 ms	B	
	EN60601-1-2	Dip: 30% 25 AC Cycles	A	230 VAC 100% load, 100 VAC 80% load
		Dip: 60% 5 AC Cycles	A	230 VAC 100% load, 100 VAC 15% load
		Dip: 100% 0.5 AC Cycles	A	
		Int.: >95% 5000 ms	B	

Electromagnetic Compatibility - Emissions

Phenomenon	Standard	Test Level	Criteria	Notes & Conditions
Conducted	EN55011/22	Class B		
Radiated	EN55011/22	Class B		
Voltage Fluctuations	EN61000-3-3			

Safety Agency Approvals

Safety Agency	Safety Standard	Category
CB Report	Certificate # US/16498/UL IEC60950-1:2005 Ed 2	Information Technology
UL	UL File #E139109-A62-UL UL60950-1 (2007), CSA 22.2 No.60950-1-07 Ed 2	Information Technology
TUV	TUV Certificate # Z1A 11 02 57396 093, EN60950-1:2006	Information Technology
Denan Japan	PSE Certificate	
CE	LVD	

Safety Agency	Safety Standard	Category
CB Report	Certificate #US/17207/UL, IEC60601-1 Ed 3 Including Risk Management	Medical
UL	UL File # E146893-V1-S9, ANSI/AAMI ES 60601-1:2005 & CSA C22.2 No. 60601-1:08	Medical
TUV	TUV Certificate # B11 07 57396 105, EN60601-1:2006	Medical

Means of Protection		Category
Primary to Secondary	2 x MOPP (Means of Patient Protection)	IEC60601-1 Ed 3
Primary to Earth	1 x MOPP (Means of Patient Protection)	
Secondary to Earth	1 x MOPP (Means of Patient Protection)	

Equipment Protection Class	Safety Standard	Notes & Conditions
Class I & Class II	IEC60950-1:2005 Ed 2 & IEC60601-1 Ed 3	See safety agency conditions of acceptability for details

Environmental Legislation

Authority	Location	Date	Notes & Conditions
EISA	US	2007	
CEC	California, US	2008	
Energy Star	US	2008	Level V
ErP Directive	Europe	2011	Regulation No. 278/2009

Mechanical Details

Weight: 1.3 lbs (600 g)
 Dimensions shown in inches (mm).

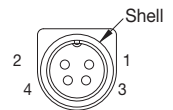
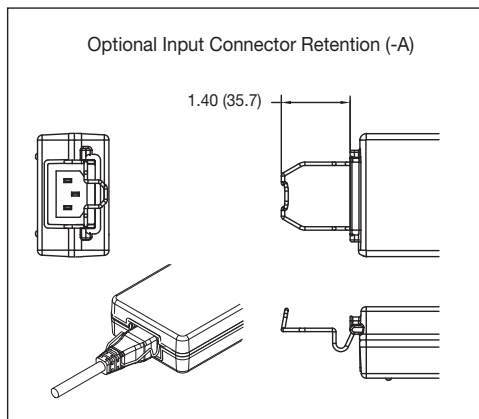
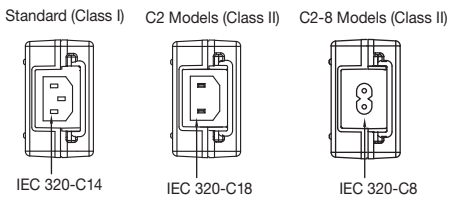
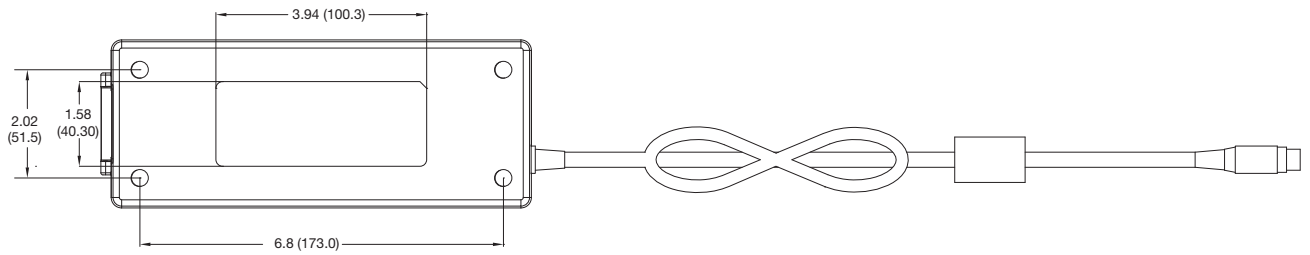
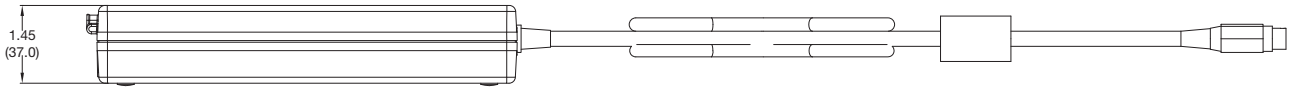
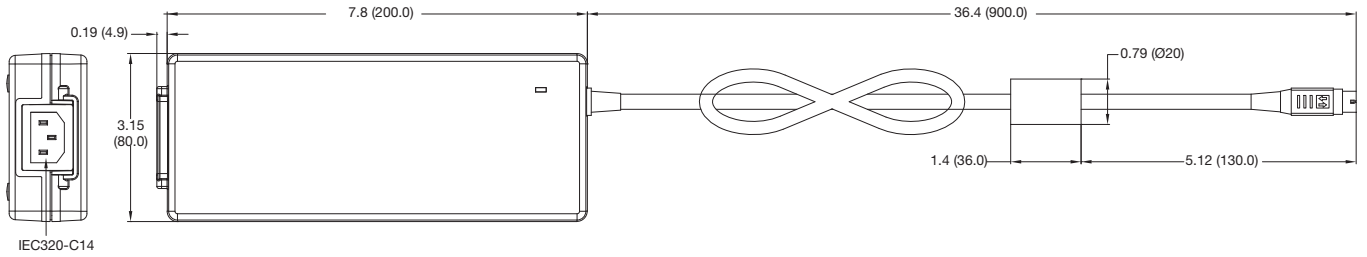

Output Connector equivalent to KPPX-4P (Non Locking)	
Pin 1	Output +
Pin 2	Output +
Pin 3	Return
Pin 4	Return
Outer Shell	GND*
Outer Shell C2 Models	Floating

* Functional earth.

AHM180 Series



- Medical & IT Safety Approvals
- Energy Star Level V
- CEC 2008 & EISA 2007 Compliant
- IP22 Environmental Rating
- Compact Format 7.90" x 3.15" x 1.61"
- <0.5 W Standby Power
- 180 W – Convection Cooled Ratings
- Class I & Class II Models
- 0 °C to +60 °C Operation
- Very Low Earth Leakage Current
- 3 Year Warranty

The AHM180 series of medical external power supplies is fully approved to international medical safety standards. It has been designed with very high efficiency and low standby power, enabling it to meet the latest environmental legislation. The unit has a fully sealed enclosure complying with IP22 and a smooth surface finish making it easier to wipe down in a clinical setting. With both medical & IT approvals the product is suitable for hospital, home healthcare, portable medical device applications and a wide range of IT applications.

Models and Ratings - Convection-cooled

Output Power	Output Voltage V1	Max Output Current	Model Number ⁽¹⁾
165 W	12.0 VDC	13.75 A	AHM180PS12
180 W	15.0 VDC	12.00 A	AHM180PS15
180 W	19.0 VDC	9.47 A	AHM180PS19
180 W	24.0 VDC	7.50 A	AHM180PS24
180 W	48.0 VDC	3.75 A	AHM180PS48
165 W	12.0 VDC	13.50 A	AHM180PS12C2
180 W	15.0 VDC	12.00 A	AHM180PS15C2
180 W	19.0 VDC	9.47 A	AHM180PS19C2
180 W	24.0 VDC	7.50 A	AHM180PS24C2
180 W	48.0 VDC	3.75 A	AHM180PS48C2

Notes:
 1. For optional input connector retention clip, add suffix 'A' to the model number e.g. AHM180PS24-A. Models with suffix C2' have a class II equipment protection classification. For IEC320-C8 input connector with class II models, add suffix '8' to the model number, e.g. AHM180PS24C2-8.

Input Characteristics

Characteristic	Minimum	Typical	Maximum	Units	Notes & Conditions
Input Voltage - Operating	80	115/230	264	VAC	Full power 90 VAC to 264 VAC. Derate output power linearly by 20% from 90 VAC to 80 VAC.
Input Frequency	47	50/60	63	Hz	
Power Factor		>0.9			EN61000-3-2 class A & D compliant & Energy Star Compliant
Input Current - No Load		0.08/0.05		A	115/230 VAC
Input Current - Full Load		1.7/0.9		A	115/230 VAC
Inrush Current		60-80	120	A	230 VAC cold start, 25 °C
No Load Input Power		0.3/0.4	0.5	W	115/230 VAC
Earth Leakage Current		50/100	200	µA	115 V 60 Hz/230 V 50 Hz (Typ.), 264 VAC/60 Hz (Max.)
		0.3/0.6		mA	115/230 VAC/400 Hz
Input Protection	T4.0A/250 V internal fuse in both lines				

Output Characteristics

Characteristic	Minimum	Typical	Maximum	Units	Notes & Conditions
Output Voltage - V1	12		48	VDC	See Models and Ratings table
Output Voltage Adjustment				%	No user adjustment
Minimum Load	0			A	
Start Up Delay		200/100		ms	115/230 VAC full load (see fig.1)
Hold Up Time		15		ms	115/230 VAC full load (see fig.2)
Drift			±0.2	%	After 20 min warm up
Line Regulation			±0.5	%	90-264 VAC (50% load)
Load Regulation			±4	%	0←50→100% load.
Transient Response - V1			5	%	Recovery within 1% in less than 500 µs for a 50-75% and 75-50% load step
Over/Undershoot - V1		3		%	
Ripple & Noise		<1	1.5	% pk-pk	20 MHz bandwidth with external circuit (see fig.3-6)
Overvoltage Protection		125		%	Vnom, Recycle AC to reset
		13.2	18	VDC	AHM180PS12 & C2
		16.5	22		AHM180PS15 & C2
		20.9	28		AHM180PS19 & C2
		26.4	33		AHM180PS24 & C2
	52.8	59	AHM180PS48 & C2		
Overload Protection		115.0	175	%	I nom, Auto reset
		16.5	23.4	A	AHM180PS12 & C2
		14.4	20.4		AHM180PS15 & C2
		10.4	16.1		AHM180PS19 & C2
		8.3	12.8		AHM180PS24 & C2
	4.5	6.4	AHM180PS48 & C2		
Short Circuit Protection					Continuous, trip & restart (hiccup mode)
Temperature Coefficient			0.05	%/°C	
Overtemperature Protection				°C	Connected to transformer. Auto reset.

Start Up Delay From AC Turn On

Figure 1
Start up example from AC turn on
(230 VAC, 196 ms)

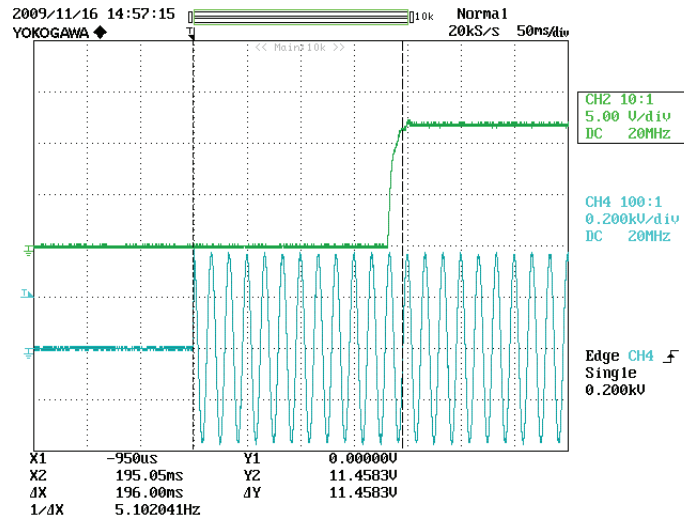

Hold Up Time From Loss of AC

Figure 2
Hold up example at 180 W load
with 230 VAC input (23 ms)

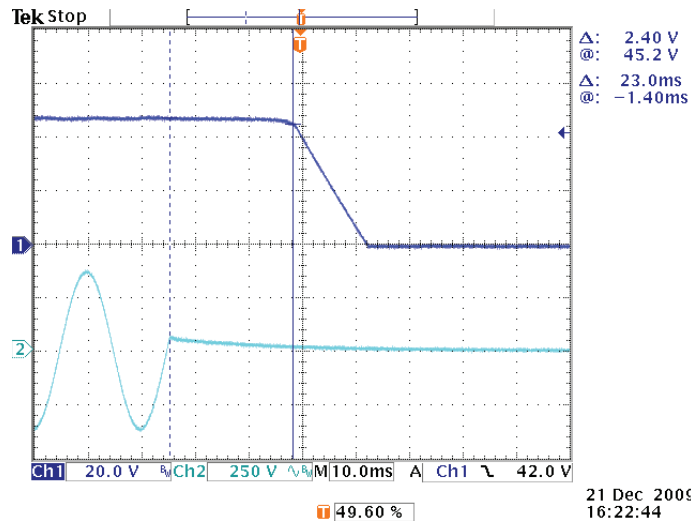

Ripple & Noise

Figure 3
AHM180PS12
Ripple & noise example at 165 W load
with 230 VAC input (50 mV)

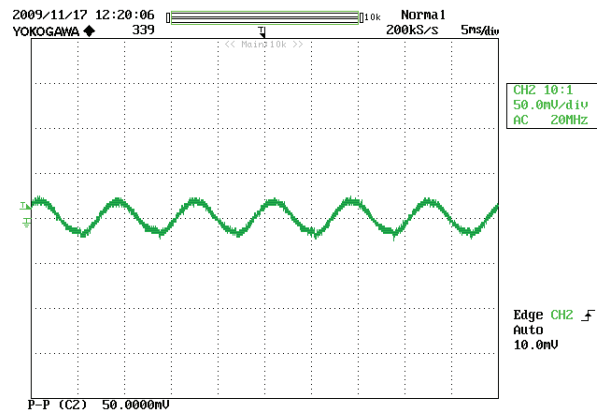

Figure 4
AHM180PS24
Ripple & noise example at 180 W load
with 230 VAC input (228 mV)

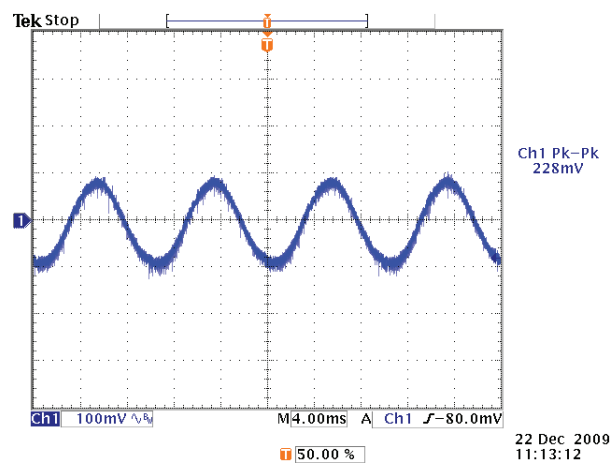

Figure 5
AHM180PS48
Ripple & noise example at 180 W load
with 230 VAC input (360 mV)

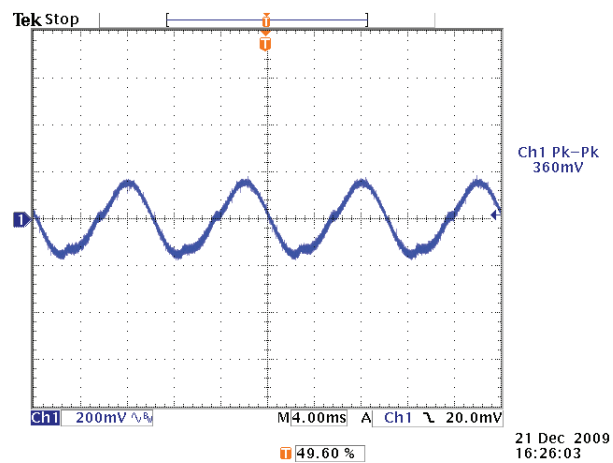
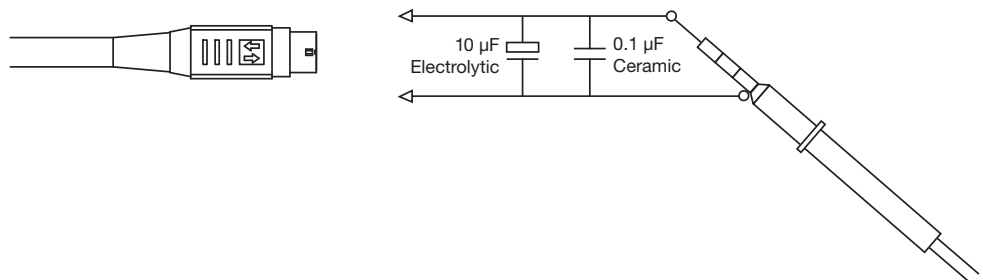

Figure 6
Ripple & noise measurement circuit



General Specifications

Characteristic	Minimum	Typical	Maximum	Units	Notes & Conditions
Efficiency		92		%	Full load (see fig.7-9)
Isolation: Input to Output Input to Ground Output to Ground	4000			VAC	
	1500			VAC	
	500			VAC	
Switching Frequency	30		200	kHz	PFC stage
	90		110		DC-DC stage
Power Density			4.4	W/in ³	
Mean Time Between Failure		156		kHrs	MIL-HDBK-217F, Notice 2 +25 °C GB
Weight		1.4 (620)		lb (g)	

Average Active Efficiency



Characteristic	Average Active Efficiency		Units	Notes & Conditions
	115 V / 60 Hz	230 VAC / 50 Hz		
AHM180PS12	90.19	91.25	%	As per Energy Star Level V test procedure
AHM180PS15	91.13	92.26		
AHM180PS19	91.28	92.44		
AHM180PS24	91.67	92.83		
AHM180PS48	92.11	93.12		

Efficiency Versus Load

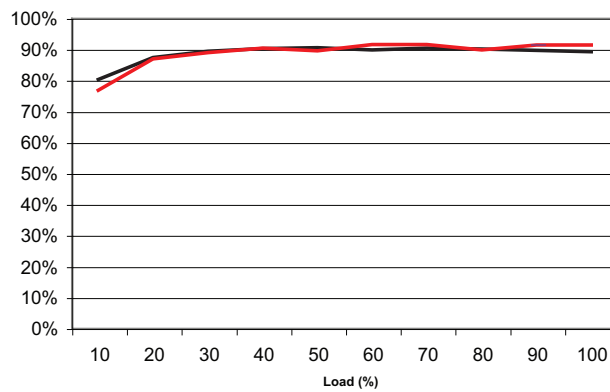

Figure 7 - AHM180PS12

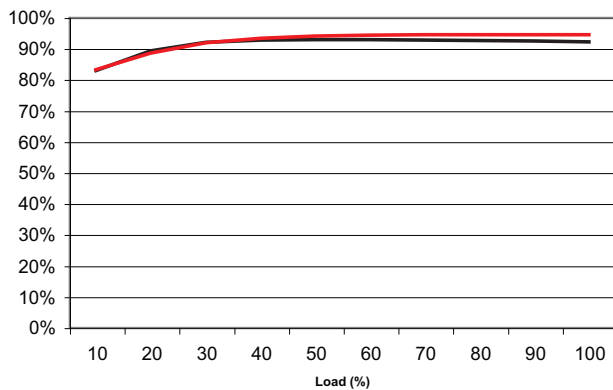

Figure 8 - AHM180PS24

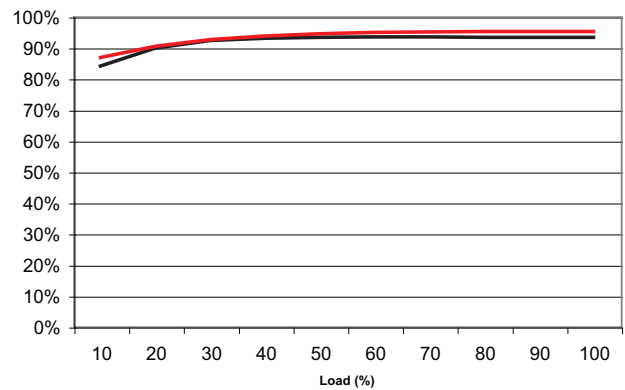
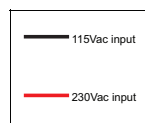

Figure 9 - AHM180PS48



Environmental

Characteristic	Minimum	Typical	Maximum	Units	Notes & Conditions
Operating Temperature	0		+60	°C	Derate linearly to 60% load at 60 °C from +40 °C. (See fig.10)
Case Temperature (IEC60601 3rd Edition)			71	°C	100% Load, with TAMB +40 °C
			60		60% Load Maximum, with TAMB +40 °C
			48		5% Load Maximum, with TAMB +40 °C
Storage Temperature	-40		+85	°C	
Cooling					Convection cooled, see fig.10
Humidity	5		95	%RH	Non-condensing
Operating Altitude			3000	m	
Ingress Protection	IP22				
Shock					3 x 30 g/11 ms shocks in both +ve & -ve directions along the 3 orthogonal axis, total 18 shocks.
Vibration					Three axis 5-500 Hz at 2 g x 10 sweeps

Derating Curve

Figure 10

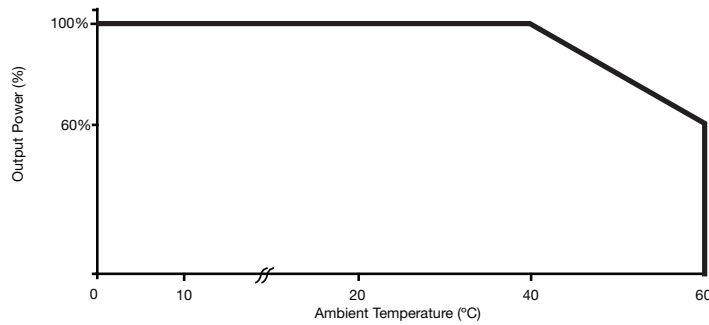

Electromagnetic Compatibility - Immunity

Phenomenon	Standard	Test Level	Criteria	Notes & Conditions
Low Voltage PSU EMC	EN61204-3	High severity level	as below	
Harmonic Current	EN61000-3-2	Class A		
ESD	EN61000-4-2	3	A	
Radiated	EN61000-4-3	3	A	
EFT	EN61000-4-4	3	A	
Surges	EN61000-4-5	Installation class 3	A	
Conducted	EN61000-4-6	3	A	
Magnetic Field	EN61000-4-8	3	A	
Dips and Interruptions	EN61000-4-11	Dip: 30% 500 ms	A	
		Dip: 60% 200 ms	B	
		Dip: 80% 5000 ms	A	
		Dip: 100% 5000 ms	B	
	EN60601-1-2	Dip: 30% 25 AC Cycles	A	230 VAC 100% load, 100 VAC 80% load
		Dip: 60% 5 AC Cycles	A	230 VAC 100% load, 100 VAC 80% load
		Dip: 100% 0.5 AC Cycles	A	
		Int.: >95% 5000 ms	B	

Electromagnetic Compatibility - Emissions

Phenomenon	Standard	Test Level	Criteria	Notes & Conditions
Conducted	EN55011/22	Class B		
Radiated	EN55011/22	Class B		
Voltage Fluctuations	EN61000-3-3			

Safety Agency Approvals

Safety Agency	Safety Standard	Category
CB Report	Certificate # US/16502/UL EC60950-1:2005 Ed 2	Information Technology
UL	UL File # E139109-A48-UL UL60950-1 (2007), CSA 22.2 No.60950-1-07 Ed 2	Information Technology
TUV	TUV Certificate # Z1A 11 02 57396 094, EN60950-1:2006	Information Technology
Denan Japan	PSE Certificate	
CE	LVD	

Safety Agency	Safety Standard	Category
CB Report	Certificate #US/17220/UL, IEC60601-1 Ed 3 Including Risk Management	Medical
UL	UL File # E146893-V1-S10, ANSI/AAMI ES 60601-1:2005 & CSA C22.2 No. 60601-1:08	Medical
TUV	TUV Certificate # B11 07 57396 104, EN60601-1:2006	Medical

Means of Protection		Category
Primary to Secondary	2 x MOPP (Means of Patient Protection)	IEC60601-1 Ed 3
Primary to Earth	1 x MOPP (Means of Patient Protection)	
Secondary to Earth	1 x MOPP (Means of Patient Protection)	

Equipment Protection Class	Safety Standard	Notes & Conditions
Class I & Class II	IEC60950-1:2005 Ed 2 & IEC60601-1 Ed 2	See safety agency conditions of acceptability for details

Environmental Legislation

Authority	Location	Date	Notes & Conditions
EISA	US	2007	
CEC	California, US	2008	
Energy Star	US	2008	Level V
ErP Directive	Europe	2011	Regulation No. 278/2009

Mechanical Details

Weight: 1.1 lbs (500 g)
 Dimensions shown in inches (mm).

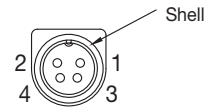
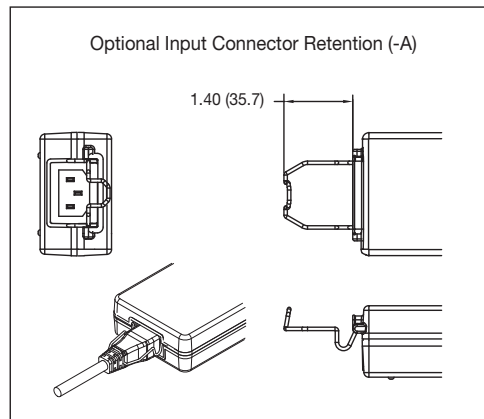
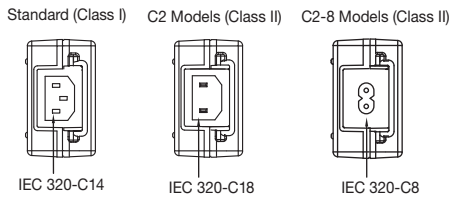
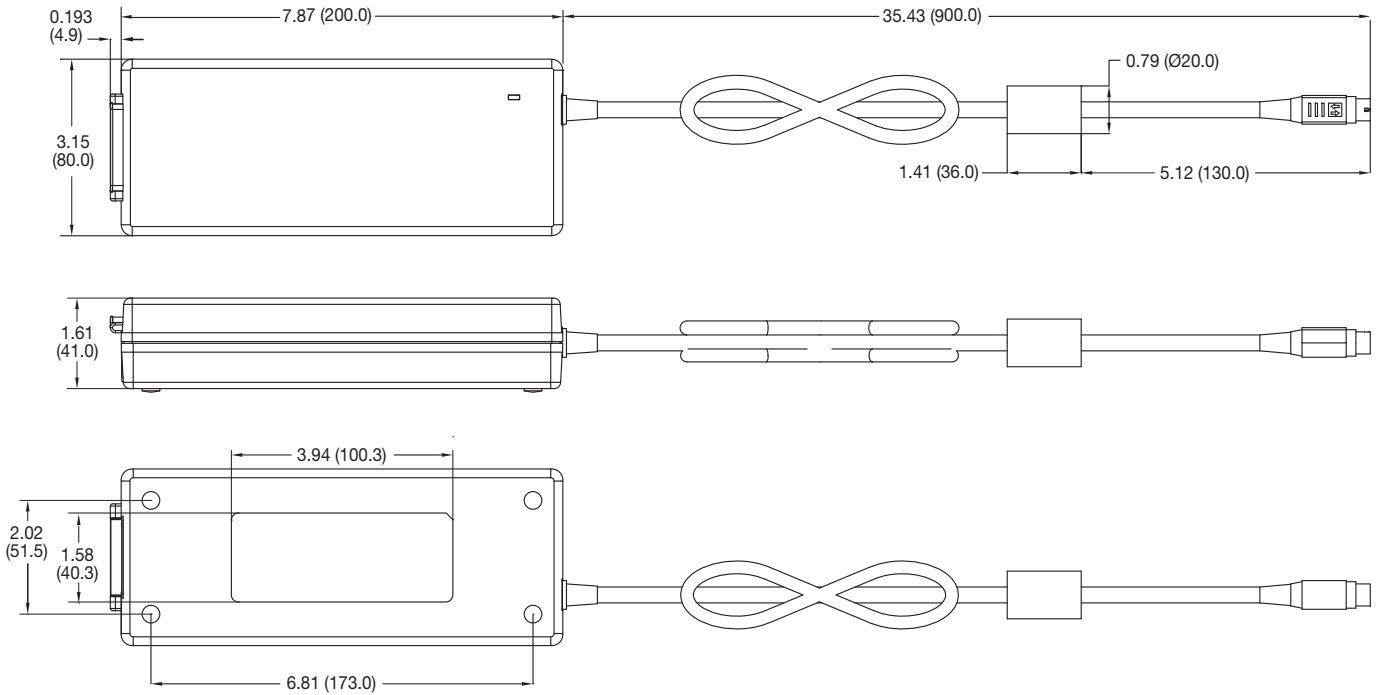

Output Connector equivalent to KPPX-4P (Non Locking)	
Pin 1	Output +
Pin 2	Output +
Pin 3	Return
Pin 4	Return
Outer Shell	GND*
Outer Shell C2 Models	Floating

* Functional earth.

AHM250 Series



- Medical & IT Safety Approvals
- Energy Star Level V
- CEC 2008 & EISA 2007 Compliant
- IP22 Environmental Rating
- Compact Format 8.60" x 3.50" x 1.46"
- <0.5 W Standby Power
- 250 W – Convection Cooled Ratings
- IEC Input Cable Retention (Optional)
- 0 °C to +60 °C Operation
- Very Low Earth Leakage Current
- 3 Year Warranty

The AHM250 series of medical external power supplies is fully approved to international medical safety standards. It has been designed with very high efficiency and low standby power, enabling it to meet the latest environmental legislation. The unit has a fully sealed enclosure complying with IP22 and a smooth surface finish making it easier to wipe down in a clinical setting. With both medical & IT approvals the product is suitable for hospital, home healthcare, portable medical device applications and a wide range of IT applications.

Models and Ratings - Convection-cooled

Output Power	Output Voltage V1	Max Output Current	Model Number
210 W	12.0VDC	17.50 A	AHM250PS12T
220 W	15.0VDC	14.66 A	AHM250PS15T
240 W	19.0VDC	12.63 A	AHM250PS19T
250 W	24.0VDC	10.41 A	AHM250PS24T
250 W	48.0VDC	5.21 A	AHM250PS48T

Notes:

1. For optional input connector retention clip, add suffix '-A' to the model number e.g. AHM250PS24T-A.
2. For 6 pin DIN connector, remove 'T' from the end of the model number e.g. AHM250PS24 (DIN connector for medical applications only).

Input Characteristics

Characteristic	Minimum	Typical	Maximum	Units	Notes & Conditions
Input Voltage - Operating	80	115/230	264	VAC	Derate <100 VAC (see fig. 1)
Input Frequency	47	50/60	63	Hz	
Power Factor		>0.9			EN61000-3-2 class A & D compliant & Energy Star Compliant
Input Current - No Load		0.09/0.10		A	115/230 VAC
Input Current - Full Load		2.3/1.2		A	115/230 VAC
Inrush Current		60-80	120	A	230 VAC cold start, 25 μ C
No Load Input Power		0.3/0.35	0.5	W	115/230 VAC
Earth Leakage Current		60/120	200	μ A	115 V 60 Hz/230 V 50 Hz (Typ.), 264 VAC/60 Hz (Max.)
		0.4/0.8		mA	115/230 VAC/400 Hz
Input Protection	T6.3A/250 V internal fuse in both lines				

Output Characteristics

Characteristic	Minimum	Typical	Maximum	Units	Notes & Conditions
Output Voltage - V1	12		48	VDC	See Models and Ratings table
Output Voltage Adjustment				%	No user adjustment
Minimum Load	0			A	
Start Up Delay		300/200		ms	115/230 VAC full load (see fig.2)
Hold Up Time		15		ms	115/230 VAC full load (see fig.3)
Drift			\pm 0.2	%	After 20 min warm up
Line Regulation			\pm 0.5	%	90-264 VAC (50% load)
Load Regulation			\pm 4	%	0 \leftarrow 50 \rightarrow 100% load.
Transient Response - V1			5	%	Recovery within 1% in less than 500 μ s for a 50-75% and 75-50% load step
Over/Undershoot - V1		3		%	
Ripple & Noise		<1	1.5	% pk-pk	20 MHz bandwidth with external circuit (see fig.4-7)
Overvoltage Protection		125		%	Vnom, Recycle AC to reset
		13.2	18	VDC	AHM250PS12
		16.5	22		AHM250PS15
		21.0	28		AHM250PS19
		26.4	33		AHM250PS24
	52.8	59	AHM250PS48		
Overload Protection		115.0	175	%	I nom, Auto reset
		21.0	29.8	A	AHM250PS12
		17.6	26.3		AHM250PS15
		15.2	21.5		AHM250PS19
		11.5	17.7		AHM250PS24
	5.7	8.9	AHM250PS48		
Short Circuit Protection					Continuous, trip & restart (hiccup mode)
Temperature Coefficient			0.05	%/°C	
Overtemperature Protection				°C	Connected to transformer. Auto reset.

Derating Curve

Figure 1

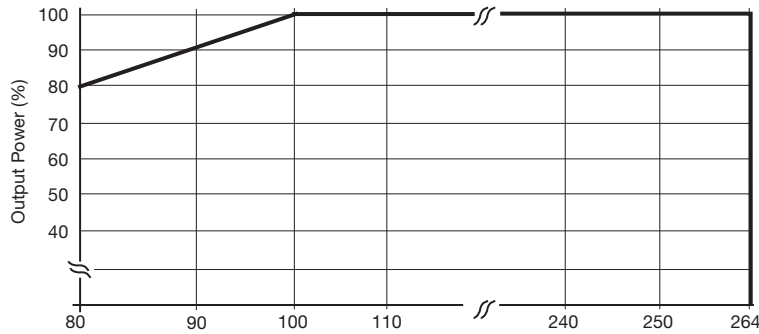

Start Up Delay From AC Turn On

Figure 2

Start up example from AC turn on
(230 VAC, 210 ms)

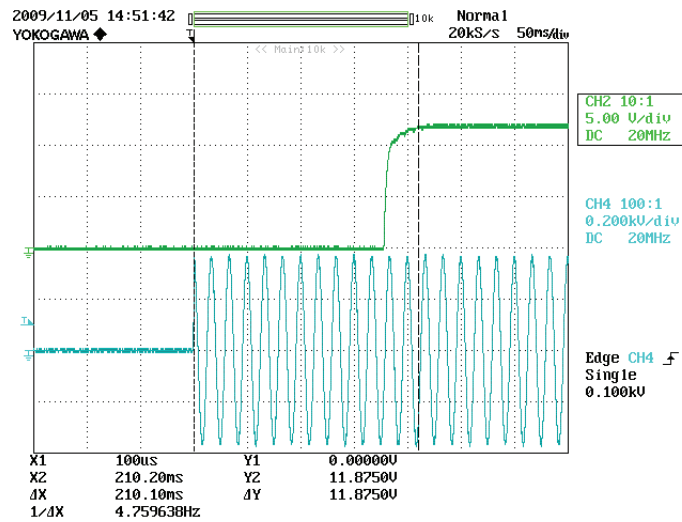

Hold Up Time From Loss of AC

Figure 3

Hold up example at 250 W load
with 230 VAC input (15 ms)

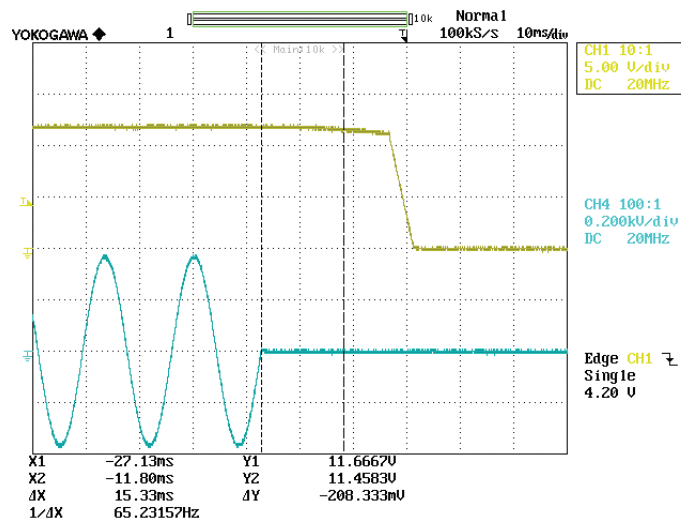

Ripple & Noise

Figure 4
AHM250PS12
Ripple & noise example at 210 W load
with 230 VAC input (50 mV)

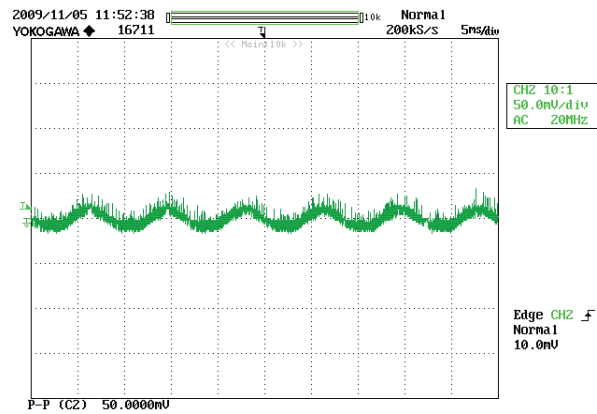

Figure 5
AHM250PS24
Ripple & noise example at 250 W load
with 230 VAC input (100 mV)

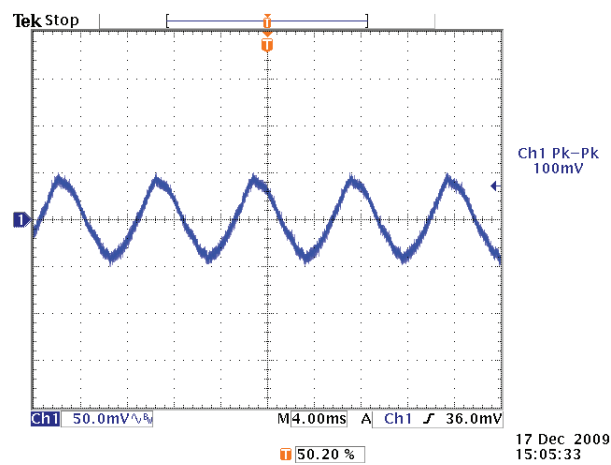

Figure 6
AHM250PS48
Ripple & noise example at 250 W load
with 230 VAC input (180 mV)

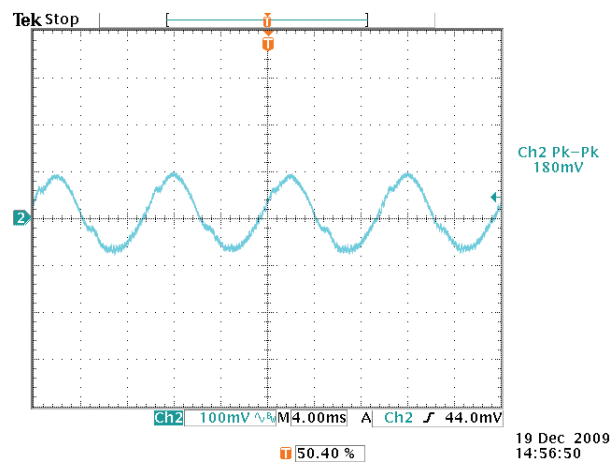
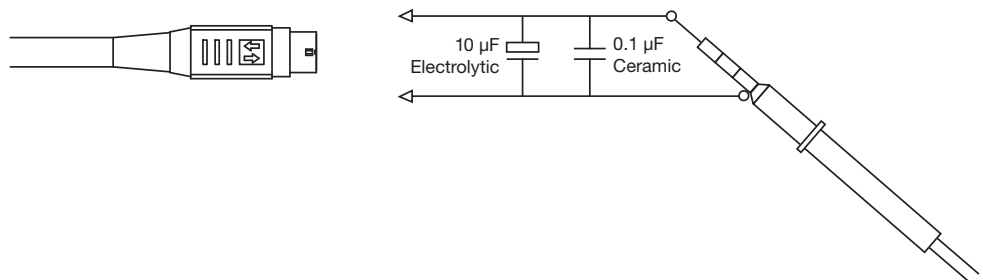

Figure 7
Ripple & noise measurement circuit



General Specifications

Characteristic	Minimum	Typical	Maximum	Units	Notes & Conditions
Efficiency		92		%	Full load (see fig.8-10)
Isolation: Input to Output Input to Ground Output to Ground	4000			VAC	
	1500			VAC	
	500			VAC	
Switching Frequency	40		220	kHz	PFC stage
	80		150		DC-DC stage
Power Density			5.7	W/in ³	
Mean Time Between Failure		151		kHrs	MIL-HDBK-217F, Notice 2 +25 °C GB
Weight		2.1 (1000)		lb (g)	

Average Active Efficiency



Characteristic	Average Active Efficiency		Units	Notes & Conditions
	115 V / 60 Hz	230 VAC / 50 Hz		
AHM250PS12	89.16	89.67	%	As per Energy Star Level V test procedure
AHM250PS15	90.05	90.71		
AHM250PS19	89.65	90.76		
AHM250PS24	91.85	92.20		
AHM250PS48	91.32	92.46		

Efficiency Versus Load

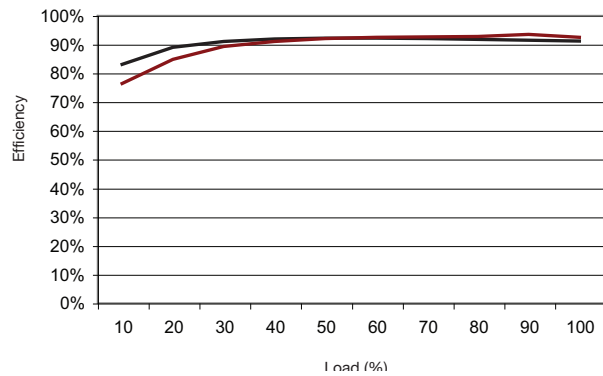

Figure 8 - AHM250PS12

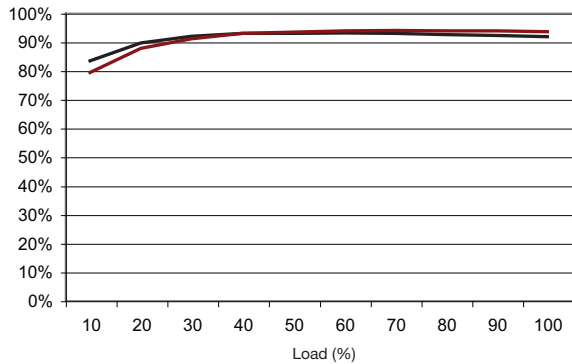

Figure 9 - AHM250PS24

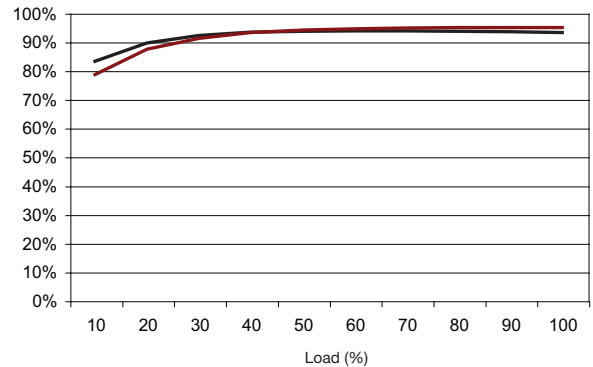
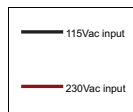

Figure 10 - AHM250PS48



Environmental

Characteristic	Minimum	Typical	Maximum	Units	Notes & Conditions
Operating Temperature	0		+60	°C	Derate linearly to 60% load at 60 °C from +40 °C. (See fig.11)
Case Temperature (IEC60601 3rd Edition)			86	°C	100% load with TAMB +40 °C
			71		80% Load, with TAMB +40 °C
			60	°C	60% Load Maximum, with TAMB +40 °C
			48		5% Load Maximum, with TAMB +40 °C
Storage Temperature	-40		+85	°C	
Cooling					Convection cooled, see fig.11
Humidity	5		95	%RH	Non-condensing
Operating Altitude			3000	m	
Ingress Protection	IP22				
Shock					3 x 30 g/11 ms shocks in both +ve & -ve directions along the 3 orthogonal axis, total 18 shocks.
Vibration					Three axis 5-500 Hz at 2 g x 10 sweeps

Derating Curve

Figure 11

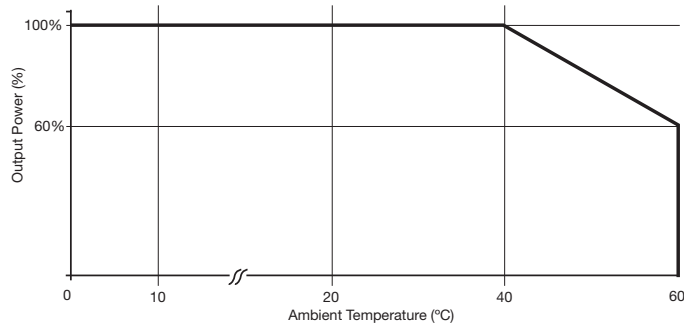

Electromagnetic Compatibility - Immunity

Phenomenon	Standard	Test Level	Criteria	Notes & Conditions
Low Voltage PSU EMC	EN61204-3	High severity level	as below	
Harmonic Current	EN61000-3-2	Class A		
ESD	EN61000-4-2	3	A	
Radiated	EN61000-4-3	3	A	
EFT	EN61000-4-4	3	A	
Surges	EN61000-4-5	Installation class 3	A	
Conducted	EN61000-4-6	3	A	
Magnetic Field	EN61000-4-8	3	A	
Dips and Interruptions	EN55024 (EN61000-4-11)	Dip: 30% 500 ms	A	
		Dip: >95% 10 ms	A	
		Int: >95% 5000 ms	B	
	EN60601-1-2	Dip: 30% 500 ms	A	230 VAC 100% load, 100 VAC 60% load
		Dip: 60% 100 ms	A	230 VAC 100% load, 100 VAC 15% load
		Dip: >95% 10 ms	A	
		Int.: >95% 5000 ms	B	

Electromagnetic Compatibility - Emissions

Phenomenon	Standard	Test Level	Criteria	Notes & Conditions
Conducted	EN55011/22	Class B		
Radiated	EN55011/22	Class B		
Voltage Fluctuations	EN61000-3-3			

Safety Agency Approvals

Safety Agency	Safety Standard	Category
CB Report	UL TBA IEC60950-1:2005 Ed 2	Information Technology
UL	UL File TBA UL60950-1 (2007), CSA 22.2 No.60950-1-07 Ed 2	Information Technology
TUV	TUV Certificate # TBA, EN60950-1:2006	Information Technology
Denan Japan	PSE Certificate	
CE	LVD	

Safety Agency	Safety Standard	Category
CB Report	Certificate #US/18020/UL, IEC60601-1 Ed 3 Including Risk Management	Medical
UL	UL File # E146893, ANSI/AAMI ES 60601-1:2005 & CSA C22.2 No. 60601-1:08	Medical
TUV	TUV Certificate # Z11 11 57396 116, EN60601-1:2006	Medical

Means of Protection		Category
Primary to Secondary	2 x MOPP (Means of Patient Protection)	IEC60601-1 Ed 3
Primary to Earth	1 x MOPP (Means of Patient Protection)	
Secondary to Earth	1 x MOPP (Means of Patient Protection)	

Equipment Protection Class	Safety Standard	Notes & Conditions
Class I	IEC60950-1:2005 Ed 2 & IEC60601-1 Ed 3	See safety agency conditions of acceptability for details

Environmental Legislation

Authority	Location	Date	Notes & Conditions
EISA	US	2007	
CEC	California, US	2008	
Energy Star	US	2008	Level V
ErP Directive	Europe	2011	Regulation No. 278/2009

Mechanical Details

Weight: 2.2 lbs (1000 g)
 Dimensions shown in inches (mm).

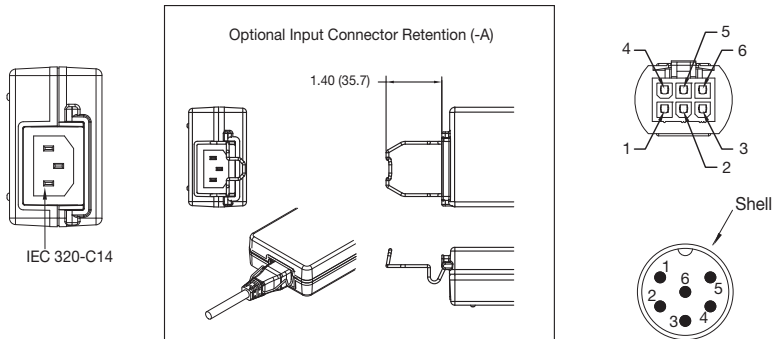
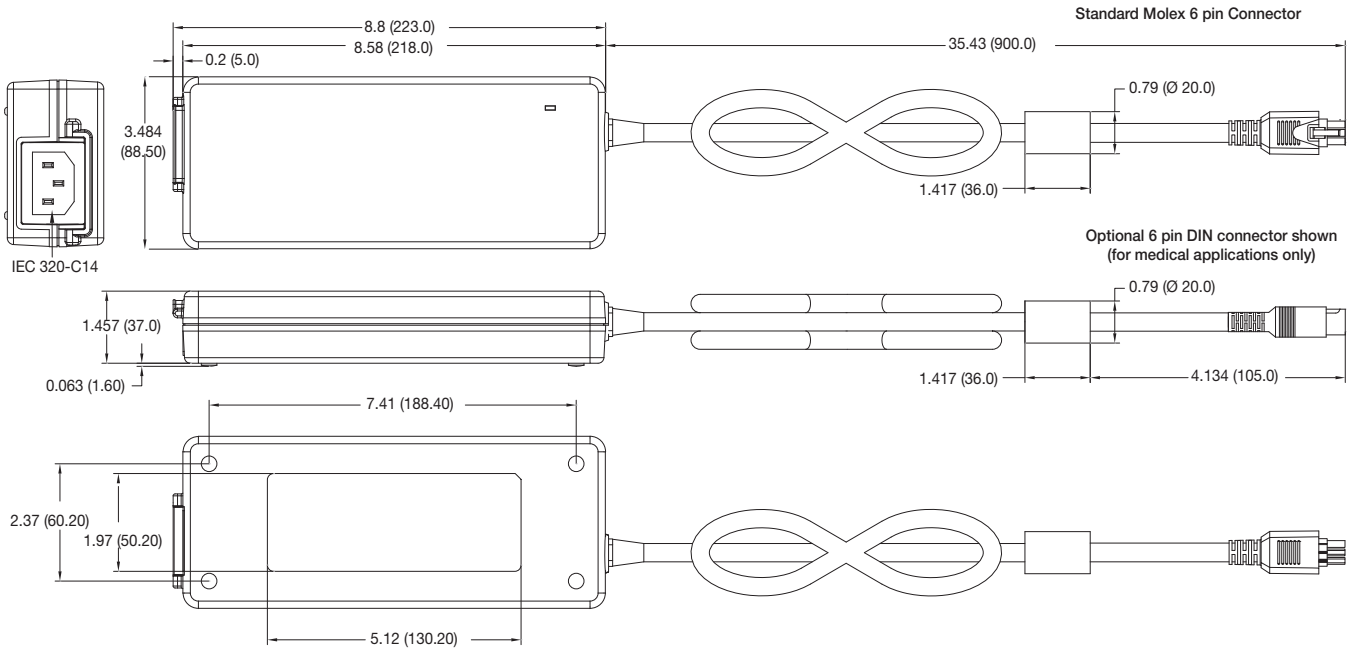

OUTPUT CONNECTOR		
Pin No.	Molex Type ⁽³⁾	DIN Type ⁽⁴⁾
Pin 1	Return	Output +
Pin 2	Return	Return
Pin 3	Return	Return
Pin 4	Output +	Return
Pin 5	Output +	Output +
Pin 6	Output +	Output +
Outer Shell		GND*

Notes

- Dimensions shown in inches (mm). Tolerance is 0.02 (0.5) maximum, except output cable length.
 - Weight 2.2 lbs (1000 g).
 - Molex part no. 50-36-1672 mates with Molex part no. 39-30-1062 or equivalent.
 - Equivalent to DIN45322 (6 pin at 60°) Male.
- * Functional earth.