

# FQ VISION SENSOR

Beyond simplicity



» One-touch operation

» Crystal-clear imaging

» Flexible platform

# Simply guided & crystal clear

*Omron defines a new era of simplicity and performance with the new FQ vision sensor range. Now you can benefit from state-of-the-art technology without complex operation instructions or technical know-how. With one-touch control via PC or the intuitive TouchFinder console, you can access all functions and settings quickly and easily.*

*Excellent image quality is achieved from even the most challenging surfaces, with advanced processing tools. And because the FQ Vision Sensor is available in a wide range of models, you won't have to compromise with a choice that has too many or too few features for your needs. So you can be sure of a best-fit solution for your particular application.*

## Features

- One-touch control via simple, icon-driven menu
- Crystal-clear image quality
- Real Color Processing (16 million colors)
- Operation via PC or handy TouchFinder screen

## Benefits

- Simple and guided set-up
- Reliable results on any surface
- Remarkable flexibility – always a perfect match and not a compromise for your application



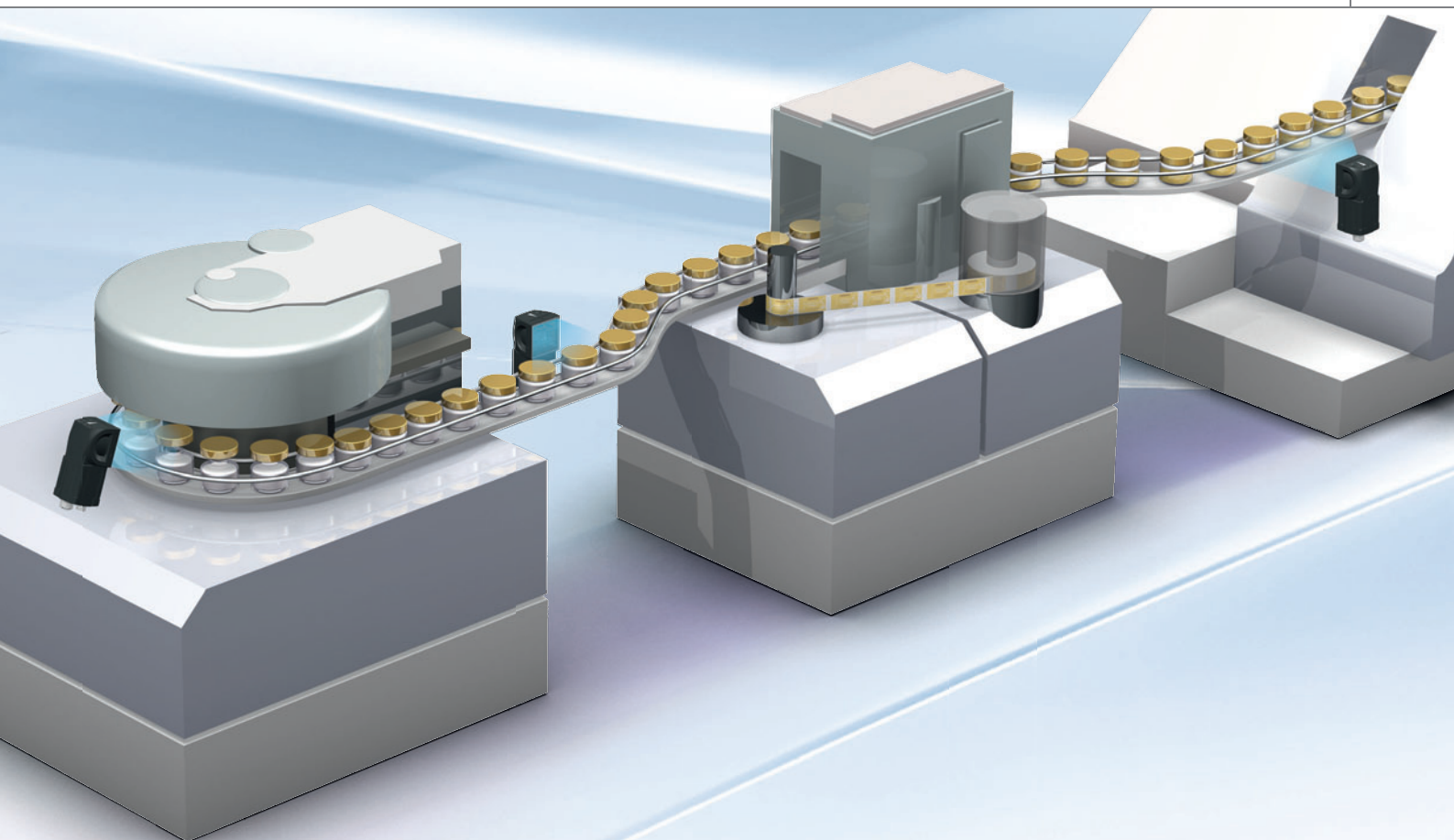

### Make it sharp

High performance LEDs and powerful filtering deliver clear images on even the most difficult surfaces.

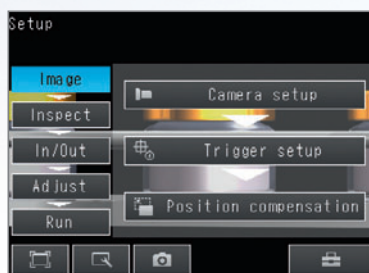

### Simple guided

Always know where you are in operation with the simple navigation menu.

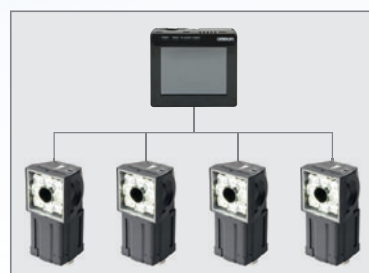

### Flexible platform

Select the vision sensor that best fits your application and decide how you want to operate it.

## Compact and robust

The FQ Vision Sensor is the most compact solution combining a camera and an image processor within one housing. No need for costly and space-consuming external lighting, thanks to the built-in lens and high performance LED. The IP67 protection class enables the FQ to be used even in harsh environments.

Compact size and robust housing – fits into any machine

High power LEDs – unique in its class

Built-in lens – simple fine tuning of camera focus

Powerful image processor: high speed inspection, outstanding filtering

Industry grade connectors for trigger and I/O, Ethernet and power.



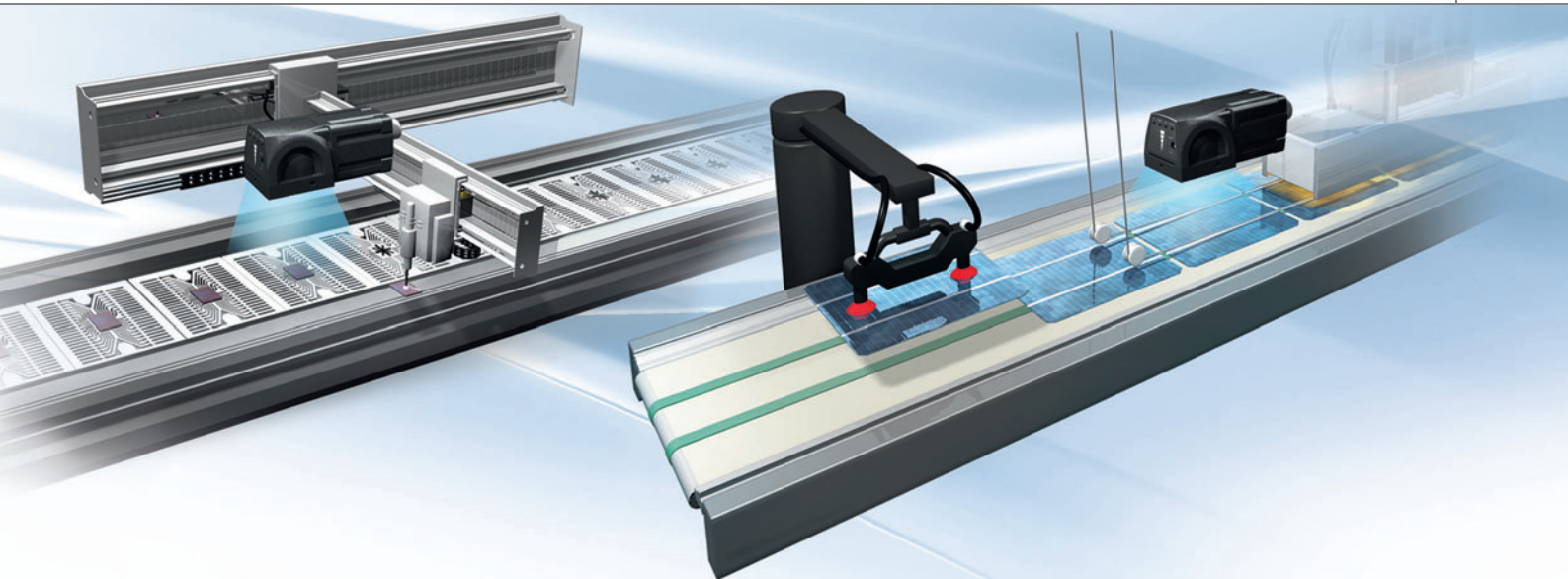

## A new benchmark in image clarity

As well as being a landmark in simplicity, the Omron FQ Vision Sensor also gives you the very best in image quality and clarity. For the first time in this class you can now benefit from a range of advanced image capture and processing features. Power LEDs, HDR, polarization and halation filters enable stable inspections on surfaces where conventional vision sensors see nothing.

The clear image enables a simple installation, as the angle of view is not critical anymore.

### Print industry: multicolor objects

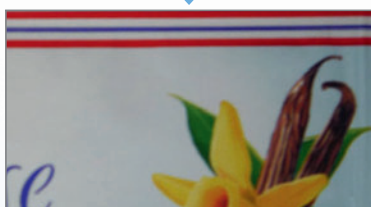

#### Real color sensing

All RGB gradations (16+ million) are processed directly. No grayscale conversion or color filtering required.

### Electrical parts: lowest contrast



#### High power lighting

Contrast was once a major issue in image processing. With the FQ Vision Sensor however, every image is bright and clear, with perfect contrast for reliable results.

### Automotive: shiny and reflective



#### HDR sensing

Variations in lighting conditions can cause unwanted glare or halation. HDR minimizes these effects, maximizing the stability of inspection results, even countering piece-to-piece variation or misalignment.

## Simply the most flexible product of its type

Flexibility meets simplicity in the Omron FQ Vision Sensor, in design, functionality and ease of use. Suitable for all types of processing and packaging applications, it can be tailored to meet even the most demanding requirements, and any operational concept.

### You decide how to set-up and configure

- PC or standalone
- Local or remote
- Portable or fixed
- Permanent or temporary

You have full control over the Omron FQ Vision Sensor, including a live image feed. Only connect the Touch Finder console or PC tool when necessary. Choose permanent installation with DIN rails, or the portable version, with rechargeable battery for full freedom of use.

### Multi-control - one for all

If your application uses multiple FQ Vision Sensors, they can be linked and controlled via one TouchFinder or PC tool.

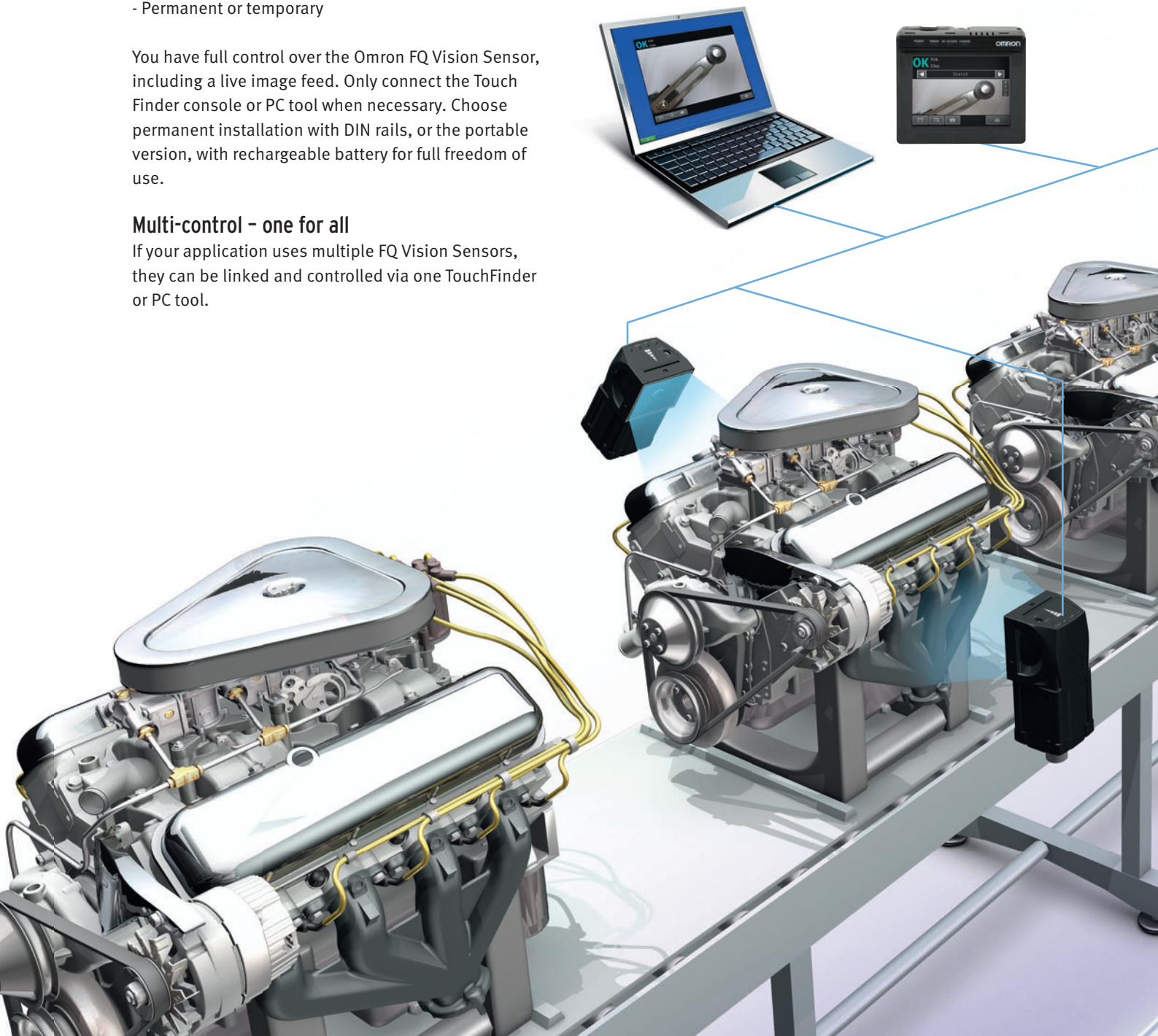

## Match your field of view

No matter whether you handle large or small workpieces, the range of Omron FQ Vision Sensors offers a perfect match. Select the FQ model with the appropriate range and adjust the field of view to your application. Focusing is quick and easy too, enabling you to use the sensor for a variety of applications.

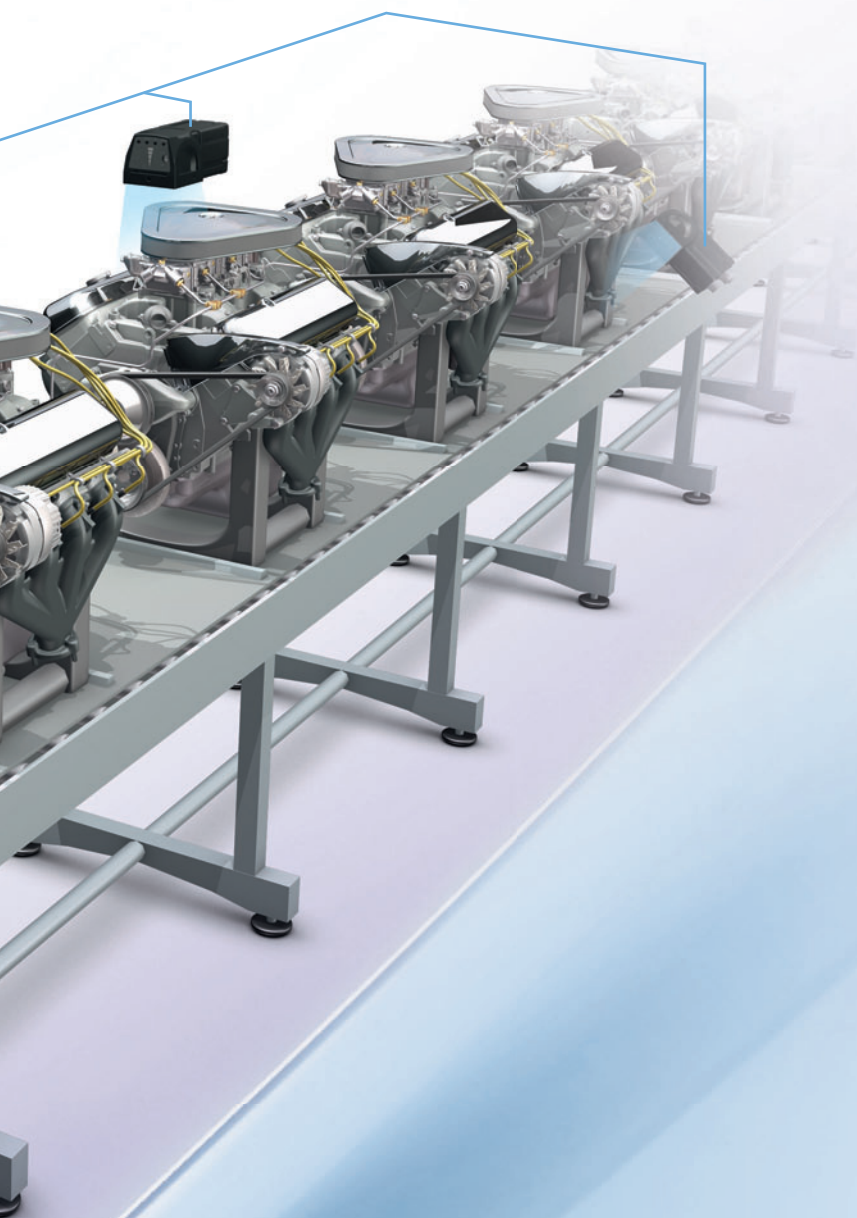

Extensive range: field of view from 7.5 - 300mm.

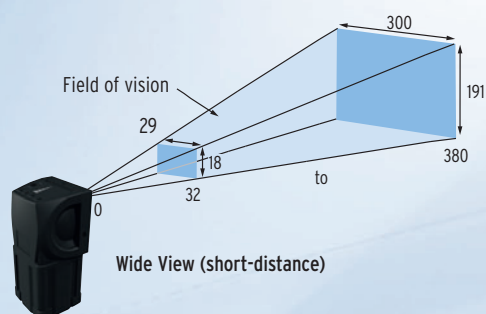
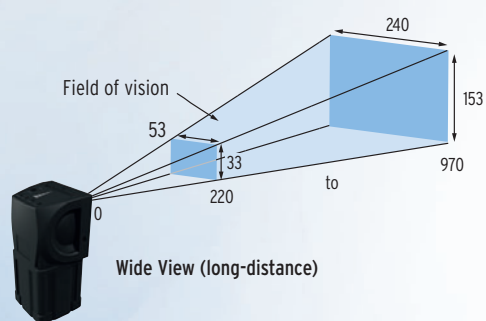
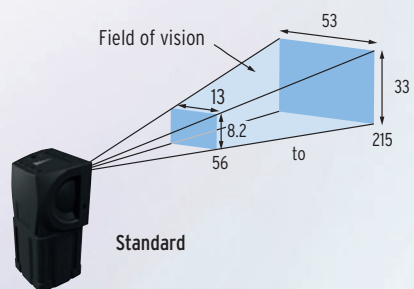
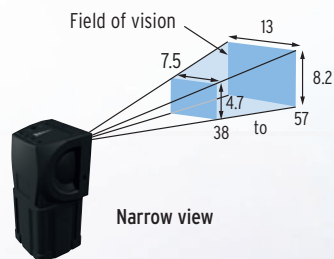

## Guided by simplicity

The FQ Vision Sensor takes you into a new dimension of simplicity and intuitive user guidance. Always know where you are thanks to the innovative navigation menu. You are guided step by step, and will quickly learn how to navigate directly to any set-up item.

Use the powerful auto-functions of the FQ to find the ideal settings. Let the FQ support you through the initial set up and any fine tuning or configuration changes. Users do not need to be experts in image sensors, since the processing intelligence is incorporated in the unit itself.

Various inspection result views are available: overview, detail, trend or distribution. The FQ display options give you the results you need to make informed decisions about your production.

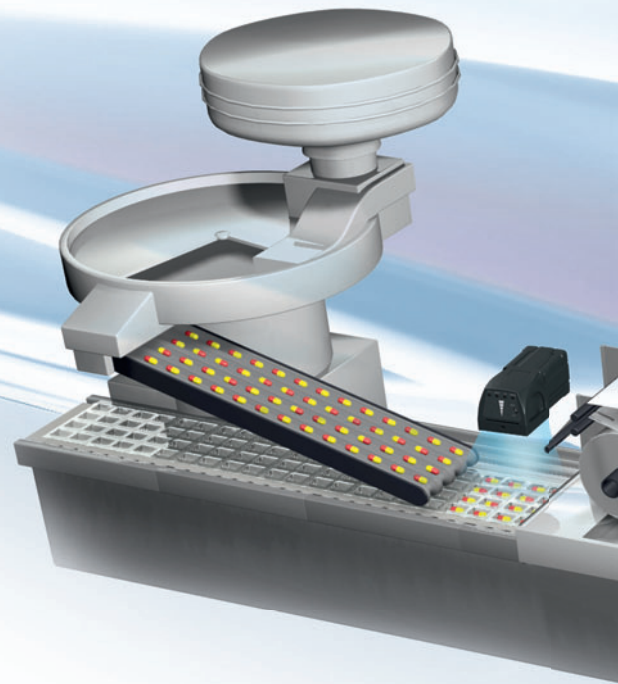

### Touch & start - inspection setup

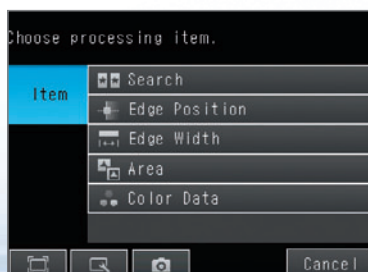

1. Select the inspection item

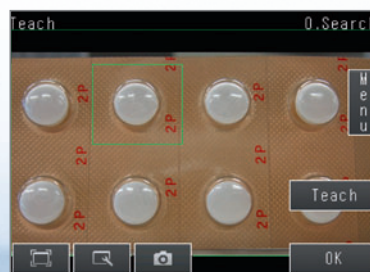

2. Teach the model



3. Set the thresholds





## Get the right results every time, in any format



### Overview of results

Display the results of all inspection items in one view. Navigate directly to each result with one touch to see the details.



### Trend monitor

See the history of inspection results over time. The trend of the production quality can be easily monitored. Countermeasures can be implemented immediately if quality goes down.

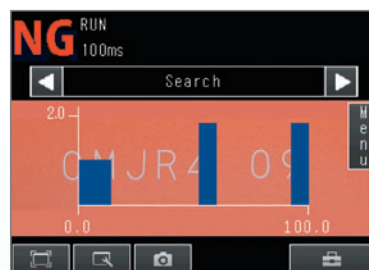

### Histogram

Show the distribution of all measurement results, giving you instant overview of overall production quality.

## Real-time Threshold Adjustment

The FQ vision sensor allows fast and easy real-time parameter adjustment.

Eliminating the need to stop the machine for fine tuning and optimisation of settings, resulting in zero machine downtime.



Judgement conditions can be adjusted on the Touch Finder.

## Inspection History Logging

Historical results logging is very useful for testing a new line. Samples are fed down the line and inspection results are logged. The logged data can be checked on a time scale in graph form and used to adjust judgement conditions.

File Logging is convenient during operation. Large inspection histories can be saved in SD cards and used later for traceability.

### Recent Results Logging



Displays the most recent 1,000 inspection results in graph form.

### File Logging



SD card

Up to 10 million measurement values or more  
(for a 4-GB SD card)  
Up to 10,000 images or more  
(for a 4-GB SD card)

## Auto Detection

When multiple sensors are connected to the touch finder, the display automatically switches to the image of the sensor which has produced an NG result.

This allows dynamic visualisation of reject conditions.

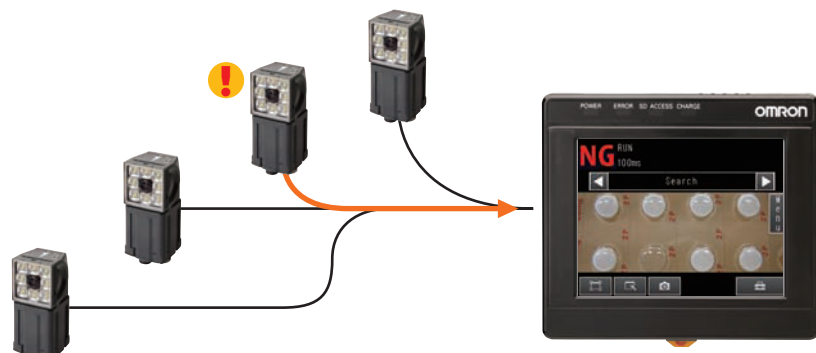

Automatically NG sensor image is displayed !

## Real Color Sensing

Most vision sensors on the market operate using greyscale image processing, due to the high demand of processing color images. However, many applications may be unsuitable or unstable using greyscale processing due to the requirement of color inspection or poor image contrast. In order to offer solutions for such issues, the FQ vision sensor combines a high power processor unit and real-color processing technology which enables fast inspections using color images. The same technology is used in Omron's flagship model of vision sensors and is widely utilised throughout industry.

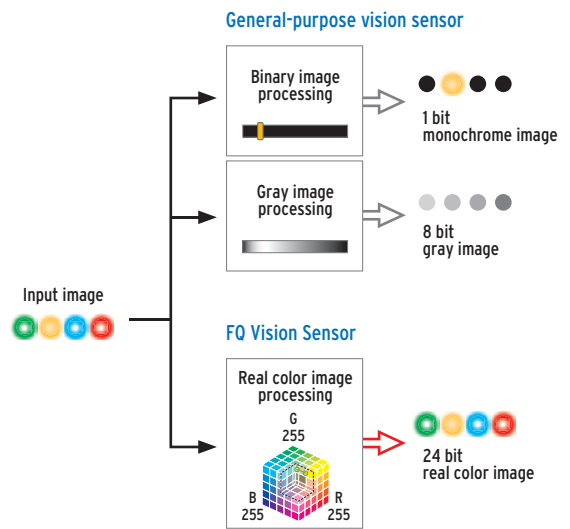

## HDR Sensing

Glossy & highly reflective surfaces can often result in "halation" or uneven brightness across an image, coupled with inconsistent workpiece placement inspections can become unstable and unreliable. Such halation is a result of the narrow dynamic range of standard vision sensors. Omron independently developed a High Dynamic Range (HDR) function and used it in our flagship model of vision sensors along with Real Color Sensing. The result is stable detection of objects which are highly reflective, even if workpiece placement is not consistent.

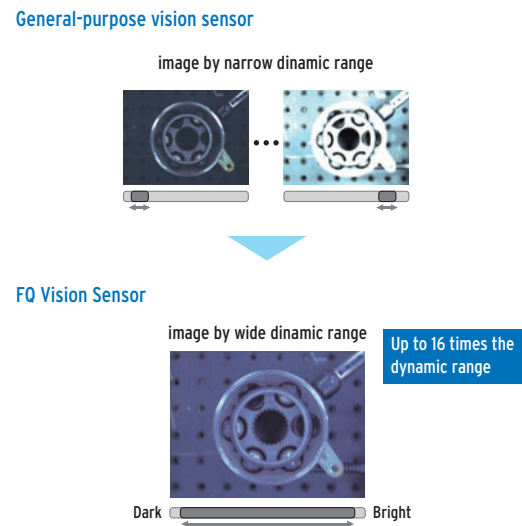

## High Power Lighting

Providing suitable illumination for inspections can often be the deciding factor between application success or failure. Especially when inspecting large field of views, even and consistent lighting can be difficult to achieve. In order to handle such issues, a new DR optical system has been developed for the FQ vision sensor. This system effectively uses all of the LED light to maintain consistent brightness across the field of view at four times the brightness of previous models. Passing light through the polarizing filter cuts off the specular reflection light which can result from highly reflective objects.

DR optical system : Double-reflection optical system

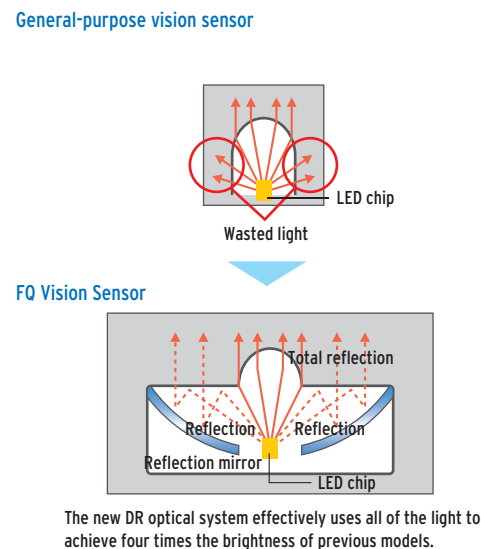

# System Configuration

## Standard Configuration Control by parallel input/output

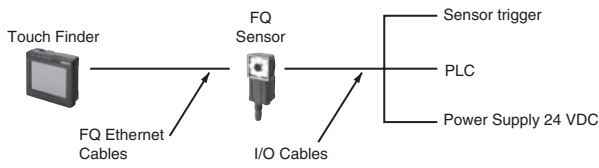

## Control by Ethernet

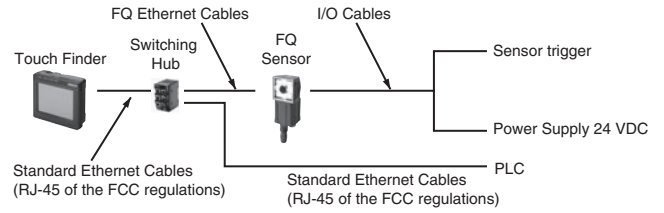

## Multiple Connection Control by parallel input/output

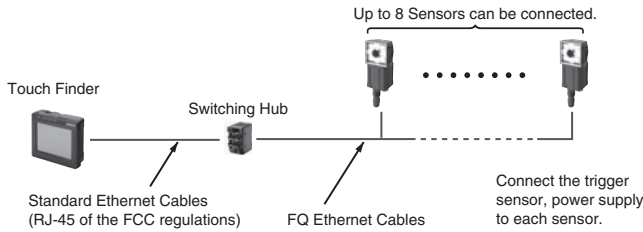

## Control by Ethernet

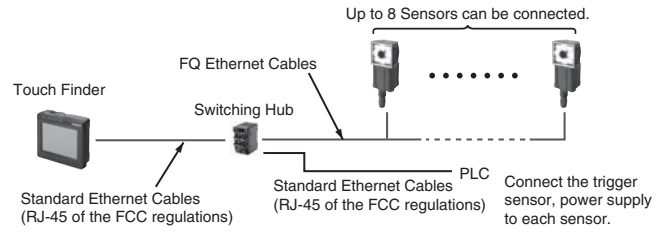

**Note:** If you register as a member after purchasing a Sensor, you can download free setup software that runs on a PC and can be used in place of the Touch Finder. Refer to the member registration sheet for details.

## Ordering Information

### Sensor

(Unit: mm)

#### Narrow View

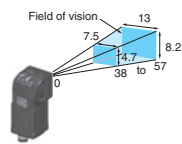

#### Standard

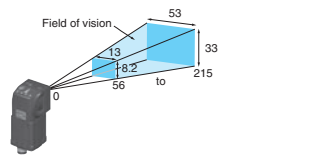

#### Wide View (Long-distance)

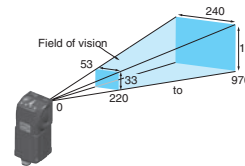

#### (Short-distance)

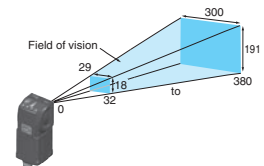

	Single-function models	Standard models		Single-function models	Standard models
NPN	FQ-S10010F	FQ-S20010F	NPN	FQ-S10050F	FQ-S20050F
PNP	FQ-S15010F	FQ-S25010F	PNP	FQ-S15050F	FQ-S25050F

	Single-function models	Standard models
NPN	FQ-S10100F	FQ-S20100F
PNP	FQ-S15100F	FQ-S25100F

	Single-function models	Standard models
NPN	FQ-S10100N	FQ-S20100N
PNP	FQ-S15100N	FQ-S25100N

**Note:** Tolerance (field of vision): ±10% max.

### Touch Finder

Type	Model
DC power supply	FQ-D30
AC/DC/battery	FQ-D31 (See note.)

**Note:** AC Adapter and Battery are sold separately.

### Cables (Robot cable)

Type	Cable length	Model
FQ Ethernet Cables (connect Sensor to Touch Finder, Sensor to PC)	2 m	FQ-WN002
	5 m	FQ-WN005
	10 m	FQ-WN010
	20 m	FQ-WN020
I/O Cables	2 m	FQ-WD002
	5 m	FQ-WD005
	10 m	FQ-WD010
	20 m	FQ-WD020

### Industrial Switching Hubs (Recommended)

Appearance	Number of ports	Failure detection	Current consumption	Model
	3	None	0.22A	W4S1-03B
	5	None	0.22A	W4S1-05B
		Supported		W4S1-05C

### Accessories

Application	Appearance	Name	Model
For Sensor		Mounting Bracket (enclosed with Sensor)	FQ-XL
		Polarizing Filter Attachment (enclosed with Sensor)	FQ-XF1
For Touch Finder		Panel Mounting Adapter	FQ-XPM
		AC Adapter (for models for DC/AC/Battery)	FQ-AC□*
		Battery (for models for DC/AC/Battery)	FQ-BAT1
		Touch Pen (enclosed with Touch Finder)	FQ-XT
		Strap	FQ-XH

\* AC Adapters for Touch Finder with DC/AC/Battery Power Supply. Select the model for the country in which the Touch Finder will be used.

Plug type	Voltage	Certified standards	Model
A	125 V max.	PSE	FQ-AC1
	250 V max.	UL/CSA	FQ-AC2
		CCC mark	FQ-AC3
C	250 V max.	---	FQ-AC4
BF	250 V max.	---	FQ-AC5
O	250 V max.	---	FQ-AC6

## Sensor

Item	Type	Single-function models	Standard models
Model	NPN	FQ-S10□□□□	FQ-S20□□□□
	PNP	FQ-S15□□□□	FQ-S25□□□□
Field of vision		Refer to the table below.	
Installation distance		Refer to the table below.	
Main functions	Inspection items	Search, area, average color, edge position, and edge width	
	Number of simultaneous inspections	1	32
	Position compensation	None	Supported
	Number of registered scenes	8	32
Image input	Image processing method	Real color	
	Image filter	High dynamic range (HDR), polarizing filter (attachment), and white balance	
	Image elements	1/3-inch color CMOS	
	Shutter	1/250 to 1/30,000	
	Processing resolution	752 x 480	
Lighting	Lighting method	Pulse	
	Lighting color	White	
	LED class (See note 1.)	Class 2	
Data logging	Measurement data	In Sensor: 1,000 items (If a Touch Finder is used, results can be saved up to the capacity of an SD card.)	
	Images	In Sensor: 20 images (If a Touch Finder is used, images can be saved up to the capacity of an SD card.)	
Auxiliary function		Math (arithmetic, calculation functions, trigonometric functions, geometric functions, and logic functions)	
Measurement trigger		External trigger (single or continuous)	
I/O specifications	Input signals	7 signals • Single measurement input (TRIG) • Control command inputs (IN0 to IN5)	
	Output signals	3 signals • Control output (BUSY) • Overall judgement output (OR) • Error output (ERROR) <b>Note:</b> The three output signals can be allocated for the judgements of individual inspection items.	
	Ethernet specification	Numerical outputs and control commands are supported with no-protocol communications. 100BASE-TX/10BASE-T	
	Connection method	Special connector cables • Power supply and I/O: 1 cable (FQ-WD□□□□) • Touch Finder and computer: 1 cable (FQ-WN□□□□)	
Ratings	Power supply voltage	20.4 to 26.4 VDC (including ripple)	
	Current consumption	2.4 A max.	
Environmental immunity	Ambient temperature range	Operating: 0 to 50°C Storage: -25 to 65°C (with no icing or condensation)	
	Ambient humidity range	Operating and storage: 35% to 85% (with no condensation)	
	Ambient atmosphere	No corrosive gas	
	Degree of protection	IEC 60529 IP67 (Except when Polarizing Filter Attachment is mounted.)	
Materials		Sensor: PBT, PC, SUS Mounting Bracket: PBT Polarizing Filter Attachment: PBT, PC Ethernet connector: Oil-resistance vinyl compound I/O connector: Lead-free heat-resistant PVC	
Weight		Depends on field of vision and installation distance. Refer to the table below.	
Accessories		<ul style="list-style-type: none"> <li>• Mounting Bracket (FQ-XL) (1)</li> <li>• Polarizing Filter Attachment (FQ-XF1) (1)</li> <li>• Instruction Manual</li> <li>• Quick Startup Guide</li> <li>• Member registration sheet</li> <li>• Warning Label</li> </ul>	

Single-function models		Standard models		Field of view (See note 2.) (Horizontal × Vertical)	Installation distance	Weight
NPN	PNP	NPN	PNP			
FQ-S10010F	FQ-S15010F	FQ-S20010F	FQ-S25010F	7.5 × 4.7 to 13 × 8.2 mm	38 to 57 mm	Approx. 160 g
FQ-S10050F	FQ-S15050F	FQ-S20050F	FQ-S25050F	13 × 8.2 to 53 × 33 mm	56 to 215 mm	Approx. 160 g
FQ-S10100F	FQ-S15100F	FQ-S20100F	FQ-S25100F	53 × 33 to 240 × 153 mm	Long-distance model: 220 to 970 mm	Approx. 150 g
FQ-S10100N	FQ-S15100N	FQ-S20100N	FQ-S25100N	29 × 18 to 300 × 191 mm	Short-distance model: 32 to 380 mm	Approx. 150 g

**Note:** 1. Applicable standards: JIS C 6802:2005  
2. Tolerance: ±10% max.

## Touch Finder

Item	Type Model	Model with DC power supply	Model with AC/DC/battery power supply
		FQ-D30	FQ-D31
Number of connectable Sensors		8 max.	
Main functions	Types of measurement displays		Last result display, Last NG display, trend monitor, histograms
	Types of display images		Through, frozen, zoom-in, and zoom-out images
	Data logging		Measurement results, measured images
	Menu language		English, German, French, Italian, Spanish, Traditional Chinese, Simplified Chinese, Korean, Japanese
Indications	LCD	Display device	3.5-inch TFT color LCD
		Pixels	320 x 240
		Display colors	16,777,216
	Backlight	Life expectancy (See note 1.)	50,000 hours at 25°C
		Brightness adjustment	Provided
Screen saver	Provided		
Operation interface	Touch screen	Method	Resistance film
		Life expectancy (See note 2.)	1,000,000
External interface	Ethernet	100BASE-TX	
	SD card	SDHC-compliant, Class 4 or higher recommended	
Ratings	Power supply voltage		DC power connection: 20.4 to 26.4 VDC (including ripple) AC adapter connection: 100 to 240 VAC, 50/60 Hz Battery connection: FQ-BAT1 Battery
	Continuous operation on Battery (See note 3.)		---
	Power consumption		DC power connection: 0.2 A
Environmental immunity	Ambient temperature range		Operating: 0 to 50°C Storage: -25 to 65°C (with no icing or condensation)
	Ambient humidity range		Operating and storage: 35% to 85% (with no condensation)
	Ambient atmosphere		No corrosive gas
	Degree of protection		IEC 60529 IP20 (when SD card cover, connector cap, or harness is attached)
Weight		Approx. 270 g (without Battery and hand strap attached)	
Materials		Case: ABS	
Accessories		Touch Pen (FQ-XT), Instruction Manual	

- Note: 1.** This is a guideline for the time required for the brightness to diminish to half the initial brightness at room temperature and humidity. The life of the backlight is greatly affected by the ambient temperature and humidity and will be shorter at lower or higher temperatures.
- 2.** This value is only a guideline. No guarantee is implied. The value will be affected by operating conditions.
- 3.** This value is only a guideline. No guarantee is implied. The value will be affected by the operating environment and operating conditions.

## Battery Specifications

Item	Model	FQ-BAT1
Battery type		Secondary lithium ion battery
Nominal capacity		1,800 mAh
Rated voltage		3.7V
Ambient temperature range		Operating: 0 to 40°C Storage: -25 to 65°C (with no icing or condensation)
Ambient humidity range		Operating and storage: 35% to 85% (with no condensation)
Charging method		Charged in Touch Finder (FQ-D31). AC adapter (FQ-AC□) is required.
Charging time (See note 1.)		2 h
Battery backup life (See note 2.)		300 charging cycles
Weight		50 g max.

- Note: 1.** This value is only a guideline. No guarantee is implied. The value will be affected by operating conditions
- 2.** This is a guideline for the time required for the capacity of the Battery to be reduced to 60% of the initial capacity. No guarantee is implied. The value will be affected by the operating environment and operating conditions.

## System Requirements for PC tool for FQ

The following Personal Computer system is required to use the software.

OS	Microsoft Windows XP Home Edition/Professional SP2 or higher (See note 1.) Microsoft Windows 7 Home Premium or higher (See note 1.)
CPU	Core 2 Duo 1.06 GHz or the equivalent or higher
RAM	1GB min.
HDD	500 MB min. available space (See note 2.)
Monitor	1,024 x 768 dots min.

- Note: 1.** The Japanese and English versions support only 32-bit OS versions.
- 2.** Available space is also required separately for data logging.

## Sensor

FQ-S10010F/-S10050F  
 FQ-S15010F/-S15050F  
 FQ-S20010F/-S20050F  
 FQ-S25010F/-S25050F

FQ-S10100F/-S10100N/-S20100N  
 FQ-S15100F/-S15100N/-S25100N  
 FQ-S20100F  
 FQ-S25100F

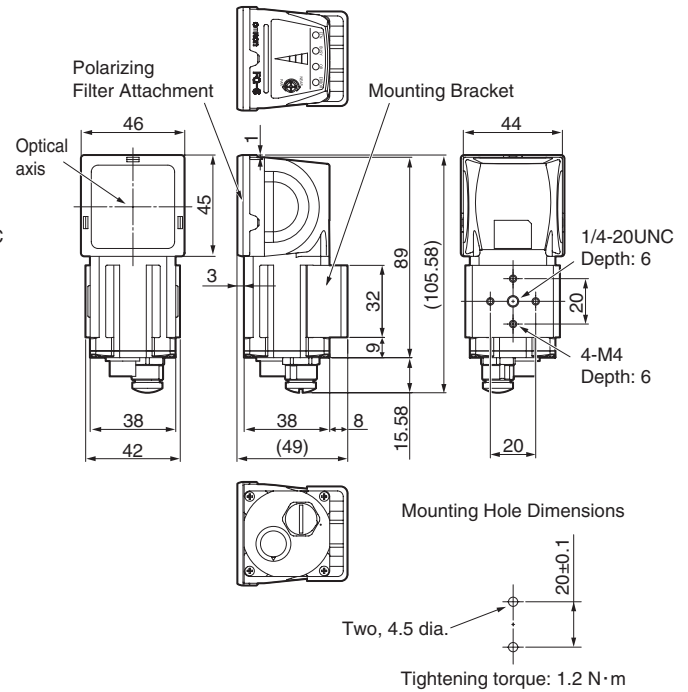
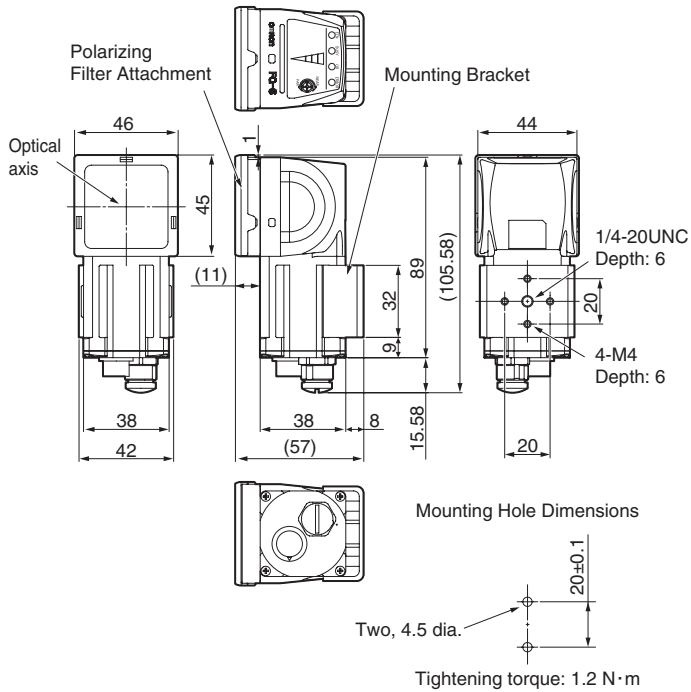

## Touch Finder

FQ-D30/-D31

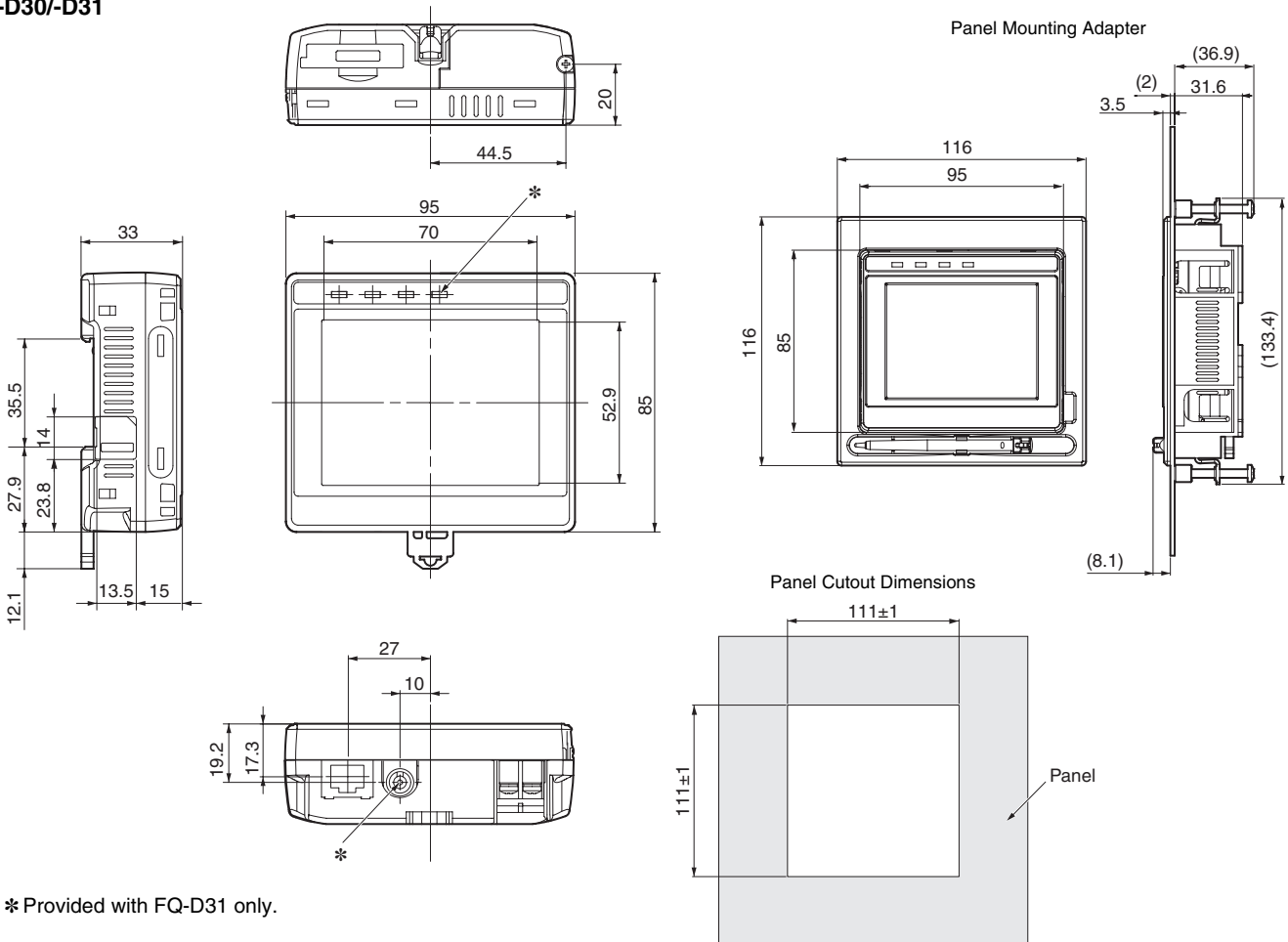

\* Provided with FQ-D31 only.

## **READ AND UNDERSTAND THIS DOCUMENT**

Please read and understand this document before using the products. Please consult your OMRON representative if you have any questions or comments.

## **WARRANTY**

OMRON's exclusive warranty is that the products are free from defects in materials and workmanship for a period of one year (or other period if specified) from date of sale by OMRON.

OMRON MAKES NO WARRANTY OR REPRESENTATION, EXPRESS OR IMPLIED, REGARDING NON-INFRINGEMENT, MERCHANTABILITY, OR FITNESS FOR PARTICULAR PURPOSE OF THE PRODUCTS. ANY BUYER OR USER ACKNOWLEDGES THAT THE BUYER OR USER ALONE HAS DETERMINED THAT THE PRODUCTS WILL SUITABLY MEET THE REQUIREMENTS OF THEIR INTENDED USE. OMRON DISCLAIMS ALL OTHER WARRANTIES, EXPRESS OR IMPLIED.

## **LIMITATIONS OF LIABILITY**

OMRON SHALL NOT BE RESPONSIBLE FOR SPECIAL, INDIRECT, OR CONSEQUENTIAL DAMAGES, LOSS OF PROFITS OR COMMERCIAL LOSS IN ANY WAY CONNECTED WITH THE PRODUCTS, WHETHER SUCH CLAIM IS BASED ON CONTRACT, WARRANTY, NEGLIGENCE, OR STRICT LIABILITY.

In no event shall responsibility of OMRON for any act exceed the individual price of the product on which liability is asserted.

IN NO EVENT SHALL OMRON BE RESPONSIBLE FOR WARRANTY, REPAIR, OR OTHER CLAIMS REGARDING THE PRODUCTS UNLESS OMRON'S ANALYSIS CONFIRMS THAT THE PRODUCTS WERE PROPERLY HANDLED, STORED, INSTALLED, AND MAINTAINED AND NOT SUBJECT TO CONTAMINATION, ABUSE, MISUSE, OR INAPPROPRIATE MODIFICATION OR REPAIR.

## **SUITABILITY FOR USE**

THE PRODUCTS CONTAINED IN THIS DOCUMENT ARE NOT SAFETY RATED. THEY ARE NOT DESIGNED OR RATED FOR ENSURING SAFETY OF PERSONS, AND SHOULD NOT BE RELIED UPON AS A SAFETY COMPONENT OR PROTECTIVE DEVICE FOR SUCH PURPOSES. Please refer to separate catalogs for OMRON's safety rated products.

OMRON shall not be responsible for conformity with any standards, codes, or regulations that apply to the combination of products in the customer's application or use of the product.

At the customer's request, OMRON will provide applicable third party certification documents identifying ratings and limitations of use that apply to the products. This information by itself is not sufficient for a complete determination of the suitability of the products in combination with the end product, machine, system, or other application or use.

The following are some examples of applications for which particular attention must be given. This is not intended to be an exhaustive list of all possible uses of the products, nor is it intended to imply that the uses listed may be suitable for the products:

- Outdoor use, uses involving potential chemical contamination or electrical interference, or conditions or uses not described in this document.
- Nuclear energy control systems, combustion systems, railroad systems, aviation systems, medical equipment, amusement machines, vehicles, safety equipment, and installations subject to separate industry or government regulations.
- Systems, machines, and equipment that could present a risk to life or property.

Please know and observe all prohibitions of use applicable to the products.

NEVER USE THE PRODUCTS FOR AN APPLICATION INVOLVING SERIOUS RISK TO LIFE OR PROPERTY WITHOUT ENSURING THAT THE SYSTEM AS A WHOLE HAS BEEN DESIGNED TO ADDRESS THE RISKS, AND THAT THE OMRON PRODUCT IS PROPERLY RATED AND INSTALLED FOR THE INTENDED USE WITHIN THE OVERALL EQUIPMENT OR SYSTEM.

## **PERFORMANCE DATA**

Performance data given in this document is provided as a guide for the user in determining suitability and does not constitute a warranty. It may represent the result of OMRON's test conditions, and the users must correlate it to actual application requirements. Actual performance is subject to the OMRON Warranty and Limitations of Liability.

## **CHANGE IN SPECIFICATIONS**

Product specifications and accessories may be changed at any time based on improvements and other reasons.

It is our practice to change model numbers when published ratings or features are changed, or when significant construction changes are made. However, some specifications of the product may be changed without any notice. When in doubt, special model numbers may be assigned to fix or establish key specifications for your application on your request. Please consult with your OMRON representative at any time to confirm actual specifications of purchased products.

## **DIMENSIONS AND WEIGHTS**

Dimensions and weights are nominal and are not to be used for manufacturing purposes, even when tolerances are shown.

## **ERRORS AND OMISSIONS**

The information in this document has been carefully checked and is believed to be accurate; however, no responsibility is assumed for clerical, typographical, or proofreading errors, or omissions.

## **PROGRAMMABLE PRODUCTS**

OMRON shall not be responsible for the user's programming of a programmable product, or any consequence thereof.

## **COPYRIGHT AND COPY PERMISSION**

This document shall not be copied for sales or promotions without permission.

This document is protected by copyright and is intended solely for use in conjunction with the product. Please notify us before copying or reproducing this document in any manner, for any other purpose. If copying or transmitting this document to another, please copy or transmit it in its entirety.

## **LED Safety**

### **WARNING**

The Sensor emits visible light, which may adversely affect the eyes in rare instances.

Do not look directly into the light emitted from the Sensor. When the subject is a specular reflective object, protect your eyes from reflected light.



### Displaying LED Labels

Attached the enclosed warning label in a readily visible location near the product, such as on the cable.





**Note: Do not use this document to operate the Unit.**

**OMRON Corporation Industrial Automation Company**  
Tokyo, JAPAN

**Contact: [www.ia.omron.com](http://www.ia.omron.com)**

**Regional Headquarters**

**OMRON EUROPE B.V.**

**Sensor Business Unit**

Carl-Benz-Str. 4, D-71154 Nufringen, Germany  
Tel: (49) 7032-811-0/Fax: (49) 7032-811-199

**OMRON ELECTRONICS LLC**

One Commerce Drive Schaumburg,  
IL 60173-5302 U.S.A.  
Tel: (1) 847-843-7900/Fax: (1) 847-843-7787

**OMRON ASIA PACIFIC PTE. LTD.**

No. 438A Alexandra Road # 05-05/08 (Lobby 2),  
Alexandra Technopark,  
Singapore 119967  
Tel: (65) 6835-3011/Fax: (65) 6835-2711

**OMRON (CHINA) CO., LTD.**

Room 2211, Bank of China Tower,  
200 Yin Cheng Zhong Road,  
PuDong New Area, Shanghai, 200120, China  
Tel: (86) 21-5037-2222/Fax: (86) 21-5037-2200

**Authorized Distributor:**

© OMRON Corporation 2010-2011 All Rights Reserved.  
In the interest of product improvement,  
specifications are subject to change without notice.

CSM\_1\_6\_0512  
**Cat. No. Q180-E1-03**

0211