

Z0109MA

Sensitive Gate Triacs Series

Silicon Bidirectional Thyristors

Designed for use in solid state relays, MPU interface, TTL logic and any other light industrial or consumer application. Supplied in an inexpensive TO-92 package which is readily adaptable for use in automatic insertion equipment.

Features

- One-Piece, Injection-Molded Package
- Blocking Voltage to 600 V
- Sensitive Gate Triggering in Four Trigger Modes (Quadrants) for all possible Combinations of Trigger Sources, and especially for Circuits that Source Gate Drives
- All Diffused and Glassivated Junctions for Maximum Uniformity of Parameters and Reliability
- Improved Noise Immunity (dv/dt Minimum of 10 V/ μ sec at 110°C)
- Commutating di/dt of 1.6 A/msec at 110°C
- High Surge Current of 8 A
- These are Pb-Free Devices

MAXIMUM RATINGS ($T_J = 25^\circ\text{C}$ unless otherwise noted)

Rating	Symbol	Value	Unit
Peak Repetitive Off-State Voltage ($T_J = -40$ to $+125^\circ\text{C}$) ⁽¹⁾ Sine Wave 50 to 60 Hz, Gate Open	V_{DRM} , V_{RRM}	600	V
On-State RMS Current Full Cycle Sine Wave 50 to 60 Hz ($T_C = 50^\circ\text{C}$)	$I_{T(RMS)}$	1.0	A
Peak Non-Repetitive Surge Current One Full Cycle, Sine Wave 60 Hz ($T_C = 110^\circ\text{C}$)	I_{TSM}	8.0	A
Circuit Fusing Considerations ($t = 8.3$ ms)	I^2t	0.35	A ² s
Average Gate Power ($T_C = 80^\circ\text{C}$, $t \leq 8.3$ ms)	$P_{G(AV)}$	1.0	W
Peak Gate Current ($t \leq 20$ μ s, $T_J = +125^\circ\text{C}$)	I_{GM}	1.0	A
Operating Junction Temperature Range	T_J	-40 to +125	$^\circ\text{C}$
Storage Temperature Range	T_{stg}	-40 to +150	$^\circ\text{C}$

Stresses exceeding Maximum Ratings may damage the device. Maximum Ratings are stress ratings only. Functional operation above the Recommended Operating Conditions is not implied. Extended exposure to stresses above the Recommended Operating Conditions may affect device reliability.

1. V_{DRM} and V_{RRM} for all types can be applied on a continuous basis. Blocking voltages shall not be tested with a constant current source such that the voltage ratings of the devices are exceeded.



ON Semiconductor

<http://onsemi.com>

TRIACS
1.0 AMPERE RMS
600 VOLTS

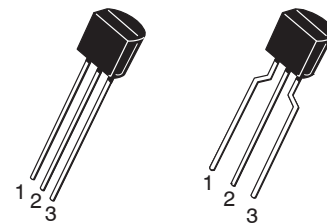
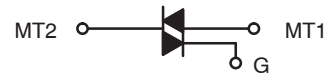

STRAIGHT LEAD
BULK PACK

BENT LEAD
TAPE & REEL
AMMO PACK

TO-92 (TO-226AA)
CASE 029
STYLE 12

MARKING DIAGRAM

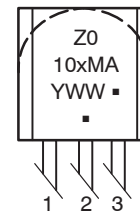

x = 3,7,9
Y = Year
WW = Work Week
▪ = Pb-Free Package
(*Note: Microdot may be in either location)

PIN ASSIGNMENT

1	Main Terminal 1
2	Gate
3	Main Terminal 2

ORDERING INFORMATION

See detailed ordering and shipping information in the package dimensions section on page 6 of this data sheet.

Z0109MA

THERMAL CHARACTERISTICS

Characteristic	Symbol	Max	Unit
Thermal Resistance, Junction-to-Case	$R_{\theta JC}$	50	$^{\circ}C/W$
Thermal Resistance, Junction-to-Ambient	$R_{\theta JA}$	160	$^{\circ}C/W$
Maximum Lead Temperature for Soldering Purposes for 10 Seconds	T_L	260	$^{\circ}C$

ELECTRICAL CHARACTERISTICS ($T_C = 25^{\circ}C$ unless otherwise noted; Electricals apply in both directions)

Characteristic	Symbol	Min	Typ	Max	Unit
----------------	--------	-----	-----	-----	------

OFF CHARACTERISTICS

Peak Repetitive Blocking Current ($V_D = \text{Rated } V_{DRM}, V_{RRM}; \text{ Gate Open}$)	$T_J = 25^{\circ}C$ $T_J = +125^{\circ}C$	I_{DRM}, I_{RRM}	- -	- -	5.0 500	μA
---	--	--------------------	--------	--------	------------	---------

ON CHARACTERISTICS

Peak On-State Voltage ($I_{TM} = \pm 1.4 \text{ A Peak}; \text{ Pulse Width} \leq 2.0 \text{ ms}, \text{ Duty Cycle} \leq 2.0\%$)		V_{TM}	-	-	1.56	V
Gate Trigger Current (Continuous dc) ($V_D = 12 \text{ Vdc}, R_L = 30 \Omega$)		I_{GT}				mA
MT2(+), G(+)			0.15	-	10	
MT2(+), G(-)			0.15	-	10	
MT2(-), G(-)			0.15	-	10	
MT2(-), G(+)			0.25	-	10	
Latching Current ($V_D = 12 \text{ V}, I_G = 1.2 \times I_{GT}$)		I_L				mA
MT2(+), G(+) All Types			-	-	15	
MT2(+), G(-) All Types			-	-	25	
MT2(-), G(-) All Types			-	-	15	
MT2(-), G(+) All Types			-	-	15	
Gate Trigger Voltage (Continuous dc) ($V_D = 12 \text{ Vdc}, R_L = 30 \Omega$)		V_{GT}				V
MT2(+), G(+) All Types			-	-	1.3	
MT2(+), G(-) All Types			-	-	1.3	
MT2(-), G(-) All Types			-	-	1.3	
MT2(-), G(+) All Types			-	-	1.3	
Gate Non-Trigger Voltage ($V_D = 12 \text{ V}, R_L = 30 \Omega, T_J = 125^{\circ}C$) All Four Quadrants		V_{GD}	0.2	-	1.3	V
Holding Current ($V_D = 12 \text{ Vdc}, \text{ Initiating Current} = 50 \text{ mA}, \text{ Gate Open}$)		I_H	-	-	10	mA

DYNAMIC CHARACTERISTICS

Rate of Change of Commutating Current ($V_D = 400 \text{ V}, I_{TM} = 0.84 \text{ A}, \text{ Commutating } dv/dt = 1.5 \text{ V}/\mu s, \text{ Gate Open}, T_J = 110^{\circ}C, f = 250 \text{ Hz}, \text{ with Snubber}$)		$di/dt(c)$	1.6	-	-	A/ms
Critical Rate of Rise of Off-State Voltage ($V_D = 67\% \text{ Rated } V_{DRM}, \text{ Exponential Waveform}, \text{ Gate Open}, T_J = 110^{\circ}C$)		dv/dt	50	75	-	V/ μs
Repetitive Critical Rate of Rise of On-State Current, $T_J = 125^{\circ}C$ Pulse Width = 20 μs , $IPK_{max} = 15 \text{ A}, diG/dt = 1 \text{ A}/\mu s, f = 60 \text{ Hz}$		di/dt	-	-	20	A/ μs

Z0109MA

Voltage Current Characteristic of Triacs (Bidirectional Device)

Symbol	Parameter
V_{DRM}	Peak Repetitive Forward Off State Voltage
I_{DRM}	Peak Forward Blocking Current
V_{RRM}	Peak Repetitive Reverse Off State Voltage
I_{RRM}	Peak Reverse Blocking Current
V_{TM}	Maximum On State Voltage
I_H	Holding Current

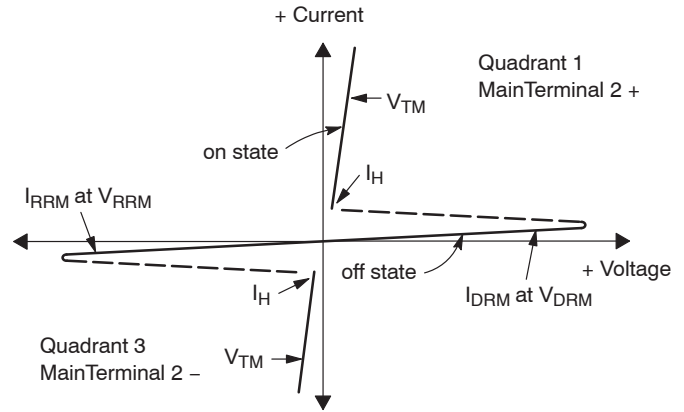

Quadrant Definitions for a Triac

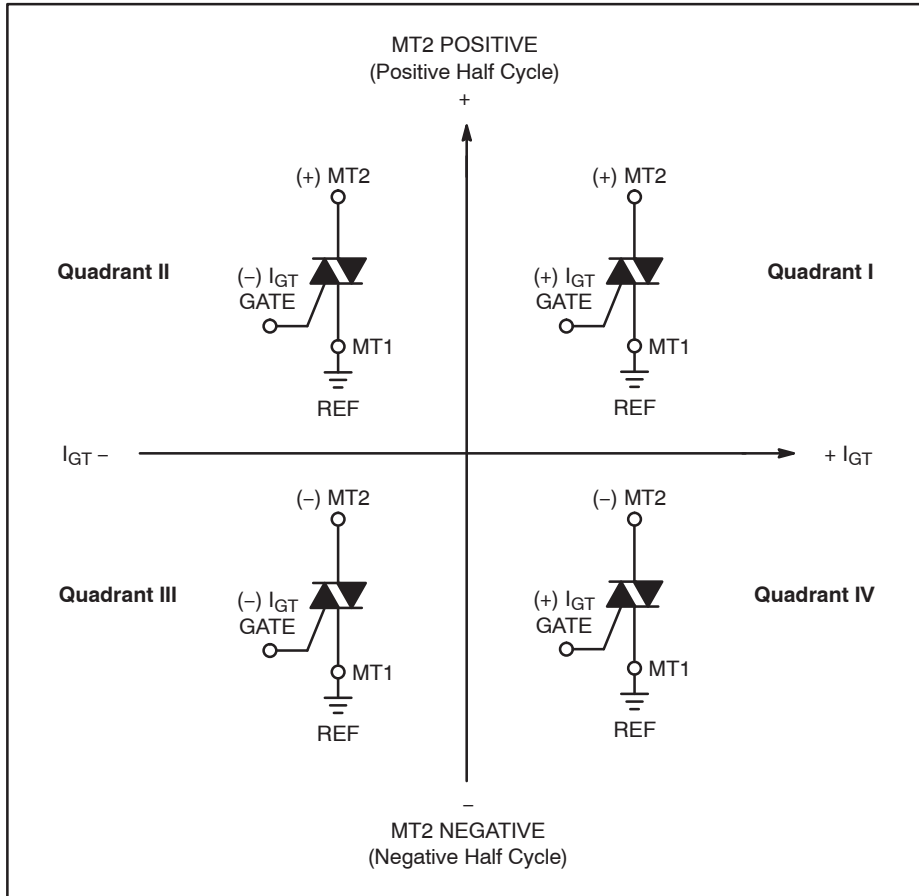

All polarities are referenced to MT1.

With in-phase signals (using standard AC lines) quadrants I and III are used.

Z0109MA

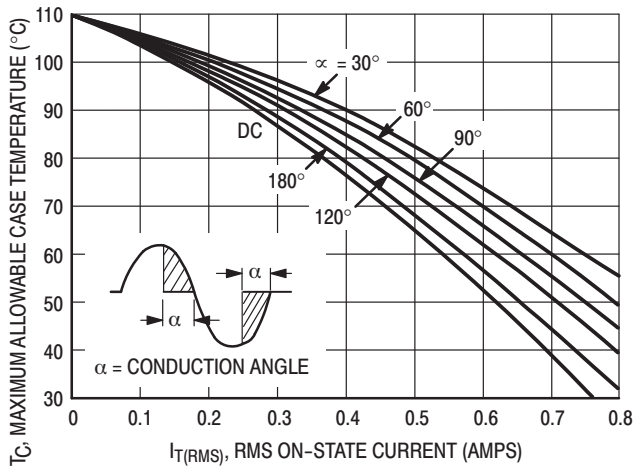

Figure 1. RMS Current Derating

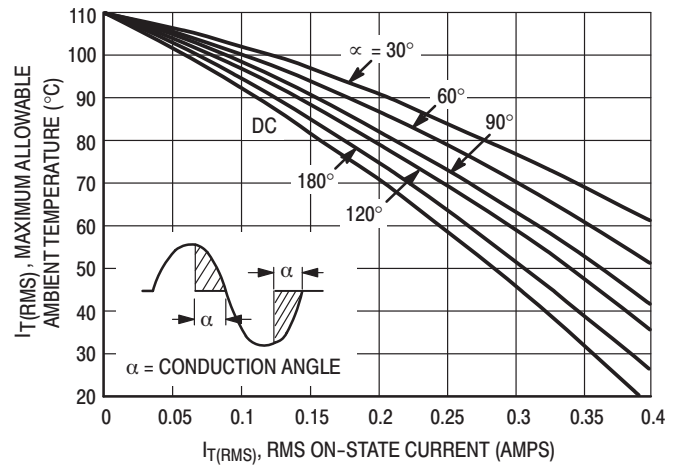

Figure 2. RMS Current Derating

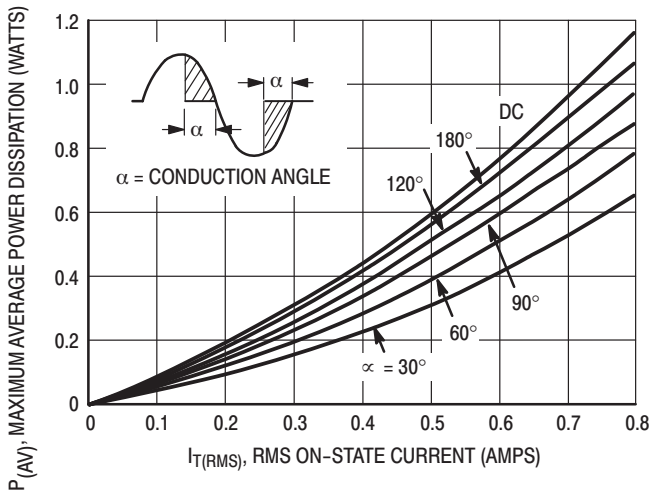

Figure 3. Power Dissipation

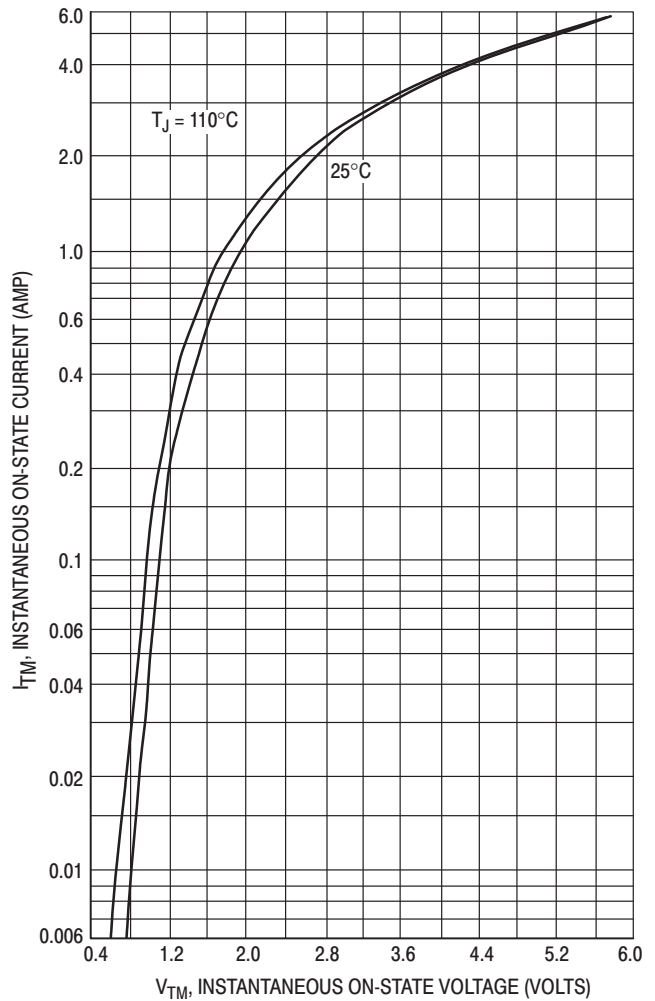

Figure 4. On-State Characteristics

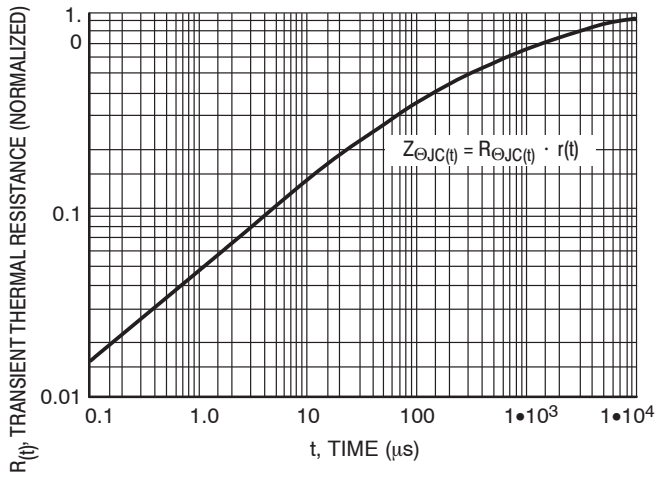

Figure 5. Transient Thermal Response

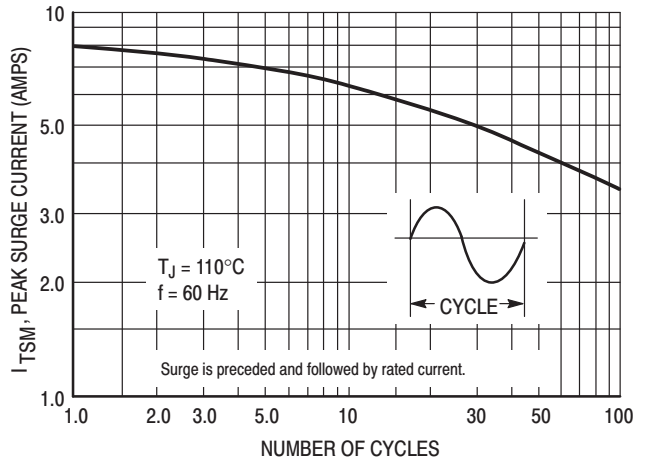

Figure 6. Maximum Allowable Surge Current

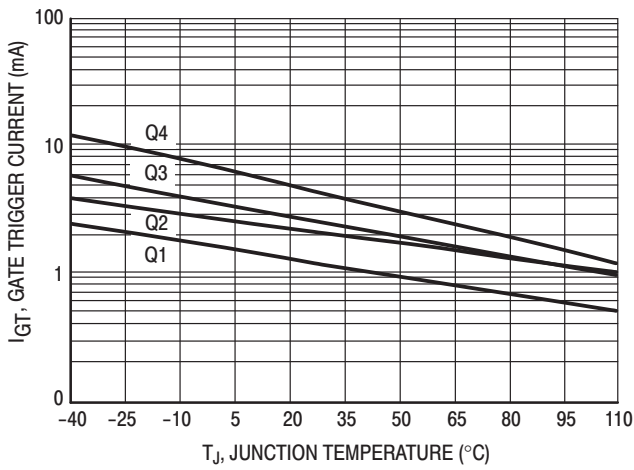

Figure 7. Typical Gate Trigger Current versus Junction Temperature

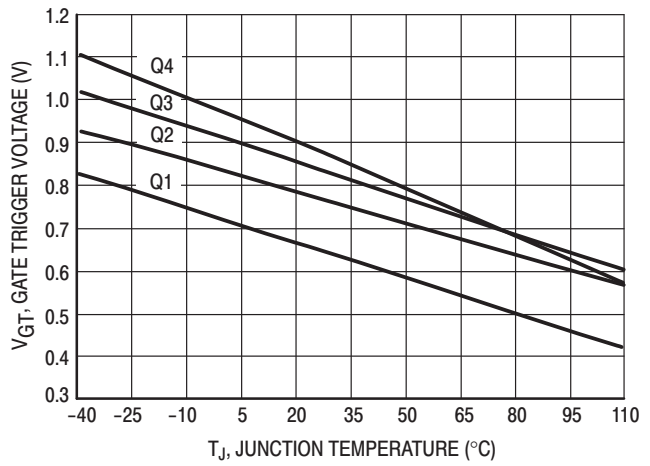

Figure 8. Typical Gate Trigger Voltage versus Junction Temperature

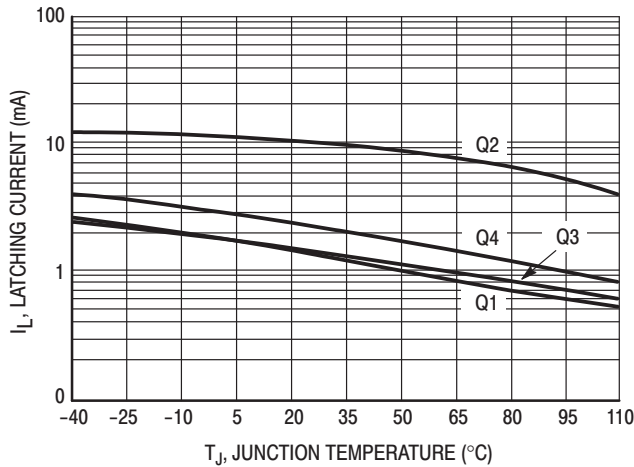

Figure 9. Typical Latching Current versus Junction Temperature

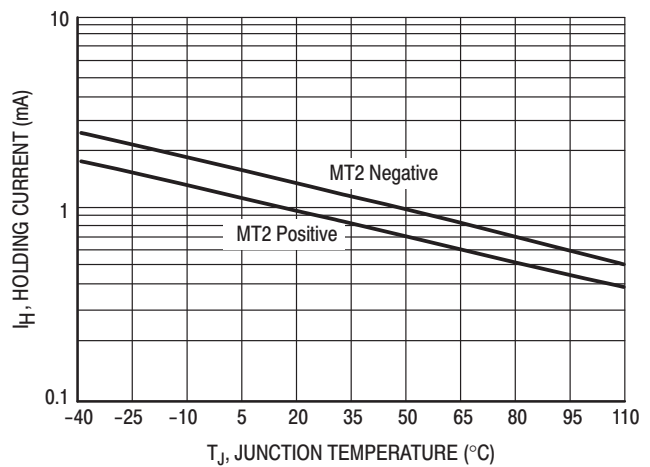
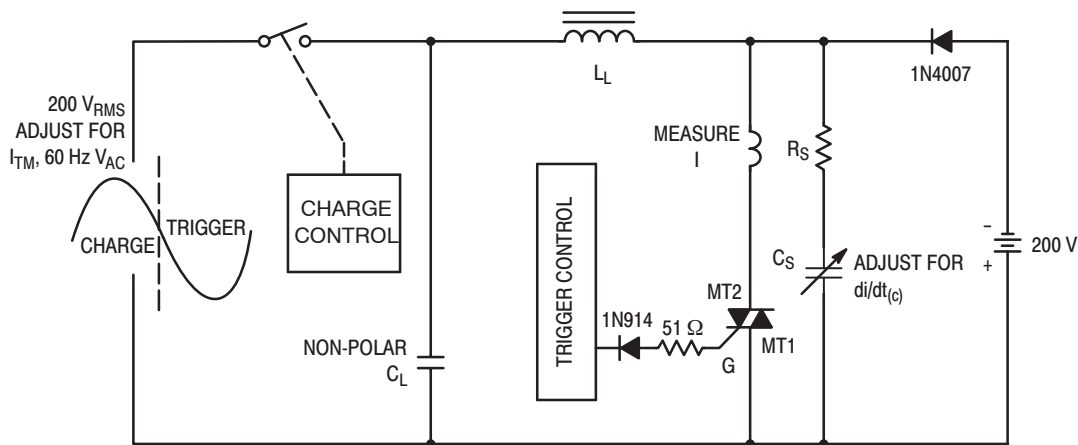

Figure 10. Typical Holding Current versus Junction Temperature

Z0109MA



Note: Component values are for verification of rated $(di/dt)_c$. See AN1048 for additional information.

Figure 11. Simplified Test Circuit to Measure the Critical Rate of Rise of Commutating Current $(di/dt)_c$

ORDERING & SHIPPING INFORMATION: Packaging Options, Device Suffix

U.S.	Europe Equivalent	Shipping [†]	Description of TO-92 Tape Orientation
	Z0109MARL1G	Radial Tape and Reel (2K/Reel)	Flat side of TO-92 and adhesive tape visible
Z0109MAG		Bulk in Box (5K/Box)	N/A, Bulk
Z0109MARLRPG		Radial Tape and Fan Fold Box (2K/Box)	Round side of TO-92 and adhesive tape visible
Z0109MARLRFG		Radial Tape and Fan Fold Box (2K/Box)	Round side of TO-92 and adhesive tape on reverse side

[†]For information on tape and reel specifications, including part orientation and tape sizes, please refer to our Tape and Reel Packaging Specification Brochure, BRD8011/D.

Z0109MA

PACKAGE DIMENSIONS

TO-92 (TO-226AA)
CASE 029-11
ISSUE AM

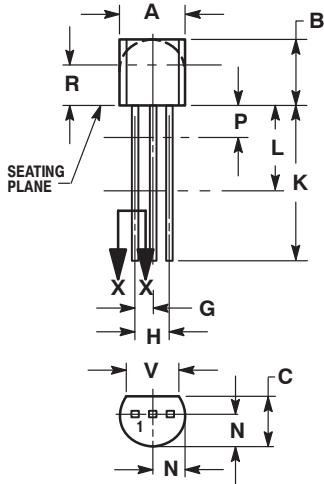

STRAIGHT LEAD
BULK PACK

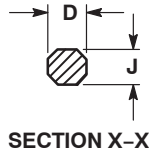

SECTION X-X

NOTES:

1. DIMENSIONING AND TOLERANCING PER ANSI Y14.5M, 1982.
2. CONTROLLING DIMENSION: INCH.
3. CONTOUR OF PACKAGE BEYOND DIMENSION R IS UNCONTROLLED.
4. LEAD DIMENSION IS UNCONTROLLED IN P AND BEYOND DIMENSION K MINIMUM.

DIM	INCHES		MILLIMETERS	
	MIN	MAX	MIN	MAX
A	0.175	0.205	4.45	5.20
B	0.170	0.210	4.32	5.33
C	0.125	0.165	3.18	4.19
D	0.016	0.021	0.407	0.533
G	0.045	0.055	1.15	1.39
H	0.095	0.105	2.42	2.66
J	0.015	0.020	0.39	0.50
K	0.500	---	12.70	---
L	0.250	---	6.35	---
N	0.080	0.105	2.04	2.66
P	---	0.100	---	2.54
R	0.115	---	2.93	---
V	0.135	---	3.43	---

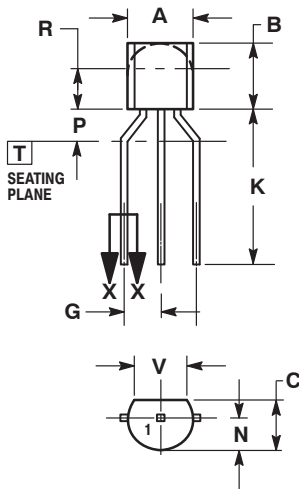

BENT LEAD
TAPE & REEL
AMMO PACK

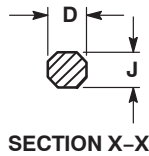

SECTION X-X

NOTES:

1. DIMENSIONING AND TOLERANCING PER ASME Y14.5M, 1994.
2. CONTROLLING DIMENSION: MILLIMETERS.
3. CONTOUR OF PACKAGE BEYOND DIMENSION R IS UNCONTROLLED.
4. LEAD DIMENSION IS UNCONTROLLED IN P AND BEYOND DIMENSION K MINIMUM.

DIM	MILLIMETERS	
	MIN	MAX
A	4.45	5.20
B	4.32	5.33
C	3.18	4.19
D	0.40	0.54
G	2.40	2.80
J	0.39	0.50
K	12.70	---
N	2.04	2.66
P	1.50	4.00
R	2.93	---
V	3.43	---

STYLE 12:

1. MAIN TERMINAL 1
2. GATE
3. MAIN TERMINAL 2

ON Semiconductor and  are registered trademarks of Semiconductor Components Industries, LLC (SCILLC). SCILLC reserves the right to make changes without further notice to any products herein. SCILLC makes no warranty, representation or guarantee regarding the suitability of its products for any particular purpose, nor does SCILLC assume any liability arising out of the application or use of any product or circuit, and specifically disclaims any and all liability, including without limitation special, consequential or incidental damages. "Typical" parameters which may be provided in SCILLC data sheets and/or specifications can and do vary in different applications and actual performance may vary over time. All operating parameters, including "Typicals" must be validated for each customer application by customer's technical experts. SCILLC does not convey any license under its patent rights nor the rights of others. SCILLC products are not designed, intended, or authorized for use as components in systems intended for surgical implant into the body, or other applications intended to support or sustain life, or for any other application in which the failure of the SCILLC product could create a situation where personal injury or death may occur. Should Buyer purchase or use SCILLC products for any such unintended or unauthorized application, Buyer shall indemnify and hold SCILLC and its officers, employees, subsidiaries, affiliates, and distributors harmless against all claims, costs, damages, and expenses, and reasonable attorney fees arising out of, directly or indirectly, any claim of personal injury or death associated with such unintended or unauthorized use, even if such claim alleges that SCILLC was negligent regarding the design or manufacture of the part. SCILLC is an Equal Opportunity/Affirmative Action Employer. This literature is subject to all applicable copyright laws and is not for resale in any manner.

PUBLICATION ORDERING INFORMATION

LITERATURE FULFILLMENT:

Literature Distribution Center for ON Semiconductor
P.O. Box 5163, Denver, Colorado 80217 USA
Phone: 303-675-2175 or 800-344-3860 Toll Free USA/Canada
Fax: 303-675-2176 or 800-344-3867 Toll Free USA/Canada
Email: orderlit@onsemi.com

N. American Technical Support: 800-282-9855 Toll Free
USA/Canada
Europe, Middle East and Africa Technical Support:
Phone: 421 33 790 2910
Japan Customer Focus Center
Phone: 81-3-5817-1050

ON Semiconductor Website: www.onsemi.com

Order Literature: <http://www.onsemi.com/orderlit>

For additional information, please contact your local Sales Representative