

NOTES:

- 1) MATERIALS: HOUSING PARTS ARE MADE OF POLYESTER, RATED UL. 94 V-0, COLOR IS BLACK; TERMINALS ARE .015/(0.38) THICK PHOSPHOR BRONZE.
- 2) TERMINAL PLATING OPTIONS PER ES-88-\*\*\*:
  - A - SELECT GOLD IN CONTACT AREA: 50 MICRONS MIN., SELECT MATTE TIN IN PC TAIL AREA: 100 MICRONS MIN., WITH OVERALL NICKEL UNDERPLATE: 50 MICRONS MIN.
- 3) THESE MODULAR JACKS MEET THE PERFORMANCE REQUIREMENTS OF MOLEX PRODUCT SPECIFICATION PS-42410.
- 4) CONNECTORS ARE TO BE PACKED IN THERMOFORMED TRAYS, PER PACKAGING SPECIFICATION PK-42410-492.
- 5) ALL JACKS ARE DESIGNED TO BE USED WITH .062/(1.57) OR .125/(3.18) THICK P.C. BOARDS.
- 6) ALL JACKS CONFORM TO AND ACCEPT PLUGS WHICH CONFORM TO FCC RULES AND REGULATIONS PART 68, SUBPART F, WHEN PLATED WITH 50 MICRONS GOLD.
- 7) ALL JACKS MUST BE CAPABLE OF FITTING INTO MOLEX GAGE G-42410 (CONNECTOR SIZE 4).
- 8) SEE SHEETS 2 & 4 FOR CONNECTOR SIZE 6.
- 9) SEE SHEETS 3 & 4 FOR CONNECTOR SIZE 8.
- 10) SEE SHEET 4 FOR ASSEMBLY ITEM NUMBERS.
- 11) PART CONFORMS TO CLASS "B" REQUIREMENTS OF COSMETIC SPECIFICATION PS-45499-002.
- 12) ENGRAVED NUMBERS ON HOUSING BODY ARE FOR MOLDING IDENTIFICATION ONLY. THEY ARE NOT INTENDED FOR ASSEMBLY IDENTIFICATION PURPOSES.
- 13) ALL UNTOLERANCED DIMENSIONS ARE SHOWN FOR REFERENCE ONLY.

P.C. BOARD THICKNESS	DIM. "D" (MTG. PEGS)	DIM. "F" (P.C. TAILS)
0.062"	.128 (3.25)	.120 +.015/-0.025 (3.05 +.38/-0.63)
0.125"	.191 (4.85)	.205 +.015/-0.025 (5.21 +.38/-0.63)

CONNECTOR SIZE	CIRCUIT SIZE	DIM. "G"
4	4	.150 (3.81)
4	2	.050 (1.27)

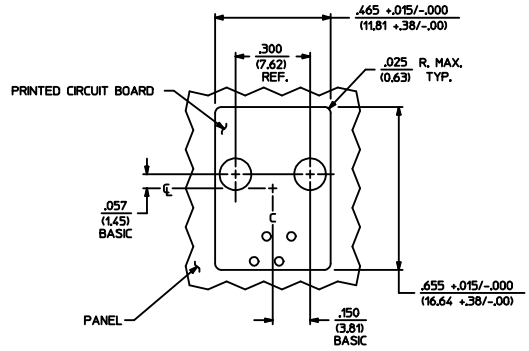
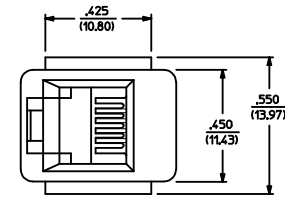

PANEL CUT-OUT FOR CONNECTOR SIZE 4

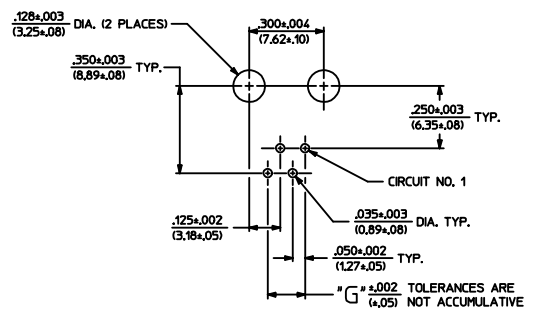

P.C. BOARD LAYOUT FOR CONNECTOR SIZE 4  
VIEWED FROM COMPONENT SIDE

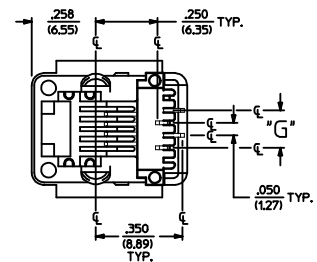
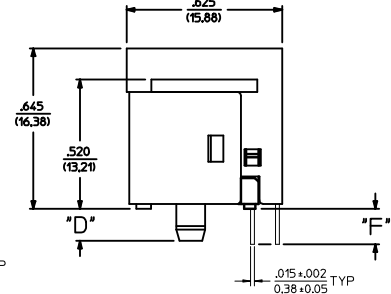
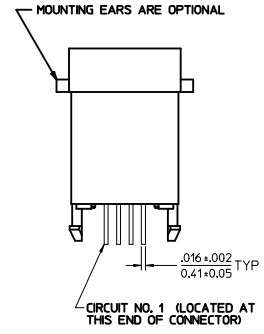

SIZE 4 MODULAR JACK LOADED WITH 4 TERMINALS SHOWN ABOVE  
(SEE SHEET 4 FOR PART NUMBER AVAILABILITY)

<b>LABEL PCB LAYOUT</b> ELEC NO: UCP2015-2536 DRAWN BY: 2015/02/24 CHKD: BELL APPR: FSMITH 2015/03/24	QUALITY SYMBOLS ∇=0 ∇=0 ∇=0	GENERAL TOLERANCES (UNLESS SPECIFIED)		DIMENSION STYLE IN/MM		SCALE 4:1	DESIGN UNITS INCH	THIRD ANGLE PROJECTION		
		mm      INCH		DRAWN BY      DATE GLT      1990/10/12		TITLE ASSEMBLY; VERTICAL MODULAR JACKS				
		4 PLACES ±      ±      ± 3 PLACES ±      ±      ±.010 2 PLACES ±0.25 ±      ±		CHECKED BY      DATE BAP      1990/10/12		MATERIAL NO. <b>SEE SHEET 4</b>			DOCUMENT NO. SDA-42410-****	SHEET NO. 1 OF 4
		1 PLACE ±      ±      ± 0 PLACE ±      ±      ±		APPROVED BY      DATE FSMITH      2012/02/14		THIS DRAWING CONTAINS INFORMATION THAT IS PROPRIETARY TO MOLEX INCORPORATED AND SHOULD NOT BE USED WITHOUT WRITTEN PERMISSION				

NOTES:

- 1) MATERIALS: HOUSING PARTS ARE MADE OF POLYESTER, RATED UL. 94 V-0. COLOR IS BLACK, TERMINALS ARE .015/(0.38) THICK PHOSPHOR BRONZE.
- 2) TERMINAL PLATING OPTIONS PER ES-88-\*\*\*\*:
  - A - SELECT GOLD IN CONTACT AREA: 50 MICROINCHES MIN., SELECT MATTE TIN IN PC TAIL AREA: 100 MICROINCHES MIN., WITH OVERALL NICKEL UNDERPLATE: 50 MICROINCHES MIN.
  - B - SELECT GOLD IN CONTACT AREA: 15 MICROINCHES MIN., SELECT MATTE TIN IN PC TAIL AREA: 100 MICROINCHES MIN., WITH OVERALL NICKEL UNDERPLATE: 50 MICROINCHES MIN.
- 3) THESE MODULAR JACKS MEET THE PERFORMANCE REQUIREMENTS OF MOLEX PRODUCT SPECIFICATION PS-42410.
- 4) CONNECTORS ARE TO BE PACKED IN THERMOFORMED TRAYS, PER PACKAGING SPECIFICATION PK-42410-492.
- 5) ALL JACKS ARE DESIGNED TO BE USED WITH .062/(1.57) OR .125/(3.18) THICK P.C. BOARDS.
- 6) ALL JACKS CONFORM TO AND ACCEPT PLUGS WHICH CONFORM TO FCC RULES AND REGULATIONS PART 68, SUBPART F, WHEN PLATED WITH 50 MICROINCHES GOLD.
- 7) ALL JACKS MUST BE CAPABLE OF FITTING INTO MOLEX GAGE G-42410 (CONNECTOR SIZE 4).
- 8) SEE SHEETS 1 & 4 FOR CONNECTOR SIZE 4.
- 9) SEE SHEETS 3 & 4 FOR CONNECTOR SIZE 8.
- 10) SEE SHEET 4 FOR ASSEMBLY ITEM NUMBERS.
- 11) PART CONFORMS TO CLASS 'B' REQUIREMENTS OF COSMETIC SPECIFICATION PS-45499-002.
- 12) ENGRAVED NUMBERS ON HOUSING BODY ARE FOR MOLDING IDENTIFICATION ONLY, THEY ARE NOT INTENDED FOR ASSEMBLY IDENTIFICATION PURPOSES.
- 13) ALL UNTOLERANCED DIMENSIONS ARE SHOWN FOR REFERENCE ONLY.

P.C. BOARD THICKNESS	DIM. "D" (MTG. PEGS)	DIM. "F" (P.C. TAILS)
0.062/(1.57)	.128 (3.25)	.120 +.015/- .025 (3.05 +.38/- .63)
0.125/(3.18)	.191 (4.85)	.205 +.015/- .025 (5.21 +.38/- .63)

CONNECTOR SIZE	CIRCUIT SIZE	DIM. "G"
6	6	.250 (6.35)
6	4	.150 (3.81)
6	2	.050 (1.27)

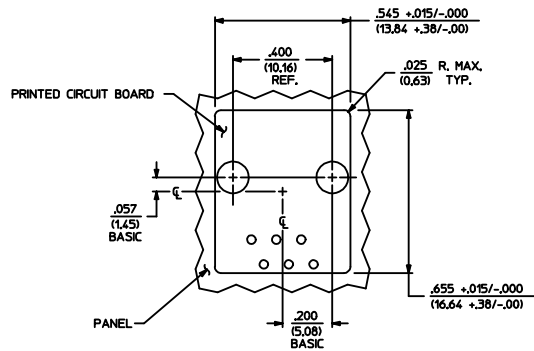
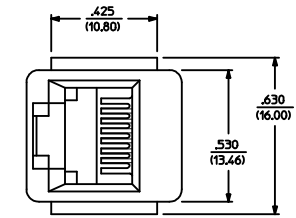

PANEL CUT-OUT FOR CONNECTOR SIZE 6

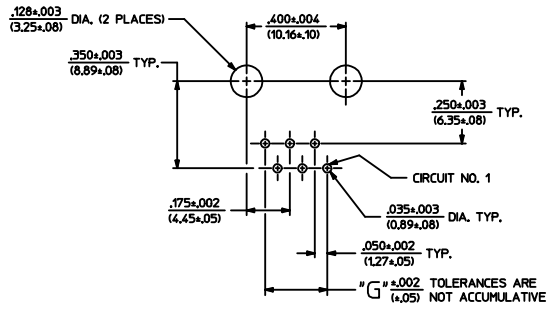

P.C. BOARD LAYOUT FOR CONNECTOR SIZE 6

VIEWED FROM COMPONENT SIDE

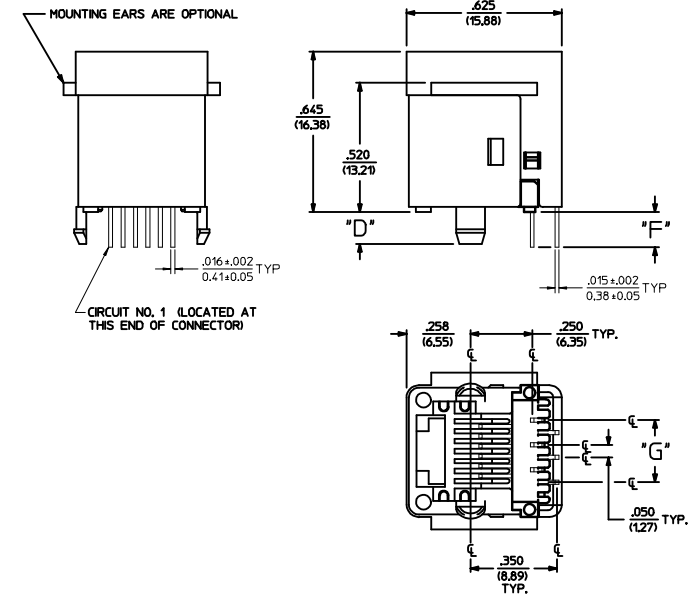

SIZE 6 MODULAR JACK LOADED WITH 6 TERMINALS SHOWN ABOVE

(SEE SHEET 4 FOR PART NUMBER AVAILABILITY)

SEE SHEET 1 EEC NO: UCP2015-2536 DRAWING NO: 2015/02/24 CHKD: BELL APPR: FSM TH 2015/03/24	QUALITY SYMBOLS ∇=0 ∇=0 ∇=0	GENERAL TOLERANCES (UNLESS SPECIFIED) mm INCH 4 PLACES ±.010 3 PLACES ±.010 2 PLACES ±0.25 1 PLACE ±.010 0 PLACE ±.010	DIMENSION STYLE IN/MM DRAWN BY DATE CHECKED BY DATE BAP 1990/10/12 APPROVED BY DATE F SMITH 2012/02/14	SCALE 4:1 DESIGN UNITS INCH	THIRD ANGLE PROJECTION ASSEMBLY: VERTICAL MODULAR JACKS
		ANGULAR ±1/2° DRAFT WHERE APPLICABLE MUST REMAIN WITHIN DIMENSIONS	MATERIAL NO. SEE SHEET 4	DOCUMENT NO. SDA-42410-****	SHEET NO. 2 OF 4

**molex**  
THIS DRAWING CONTAINS INFORMATION THAT IS PROPRIETARY TO MOLEX INCORPORATED AND SHOULD NOT BE USED WITHOUT WRITTEN PERMISSION

- NOTES:
- 1) MATERIALS: HOUSING PARTS ARE MADE OF POLYESTER, RATED UL 94 V-0. COLOR IS BLACK. TERMINALS ARE .015/(0.38) THICK PHOSPHOR BRONZE.
  - 2) TERMINAL PLATING OPTIONS PER ES-88-\*\*\*\*  
A = SELECT GOLD IN CONTACT AREA: 50 MICRONS MIN.  
SELECT MATTE TIN IN PC TAIL AREA: 100 MICRONS MIN.  
WITH OVERALL NICKEL UNDERPLATE: 50 MICRONS MIN.
  - 3) THESE MODULAR JACKS MEET THE PERFORMANCE REQUIREMENTS OF MOLEX PRODUCT SPECIFICATION PS-42410.
  - 4) CONNECTORS ARE TO BE PACKED IN THERMOFORMED TRAYS, PER PACKAGING SPECIFICATION PK-42410-492.
  - 5) ALL JACKS ARE DESIGNED TO BE USED WITH .062/(1.57) OR .125/(3.18) THICK P.C. BOARDS.
  - 6) ALL JACKS CONFORM TO AND ACCEPT PLUGS WHICH CONFORM TO FCC RULES AND REGULATIONS PART 68, SUBPART F, WHEN PLATED WITH 50 MICRONS GOLD.
  - 7) ALL JACKS MUST BE CAPABLE OF FITTING INTO MOLEX GAGE G-42410 (CONNECTOR SIZE 4).
  - 8) SEE SHEETS 1 & 4 FOR CONNECTOR SIZE 4.
  - 9) SEE SHEETS 2 & 4 FOR CONNECTOR SIZE 6.
  - 10) SEE SHEET 4 FOR ASSEMBLY ITEM NUMBERS.
  - 11) PART CONFORMS TO CLASS "B" REQUIREMENTS OF COSMETIC SPECIFICATION PS-45499-002.
  - 12) ENGRAVED NUMBERS ON HOUSING BODY ARE FOR MOLDING IDENTIFICATION ONLY. THEY ARE NOT INTENDED FOR ASSEMBLY IDENTIFICATION PURPOSES.
  - 13) ALL UNTOLERANCED DIMENSIONS ARE SHOWN FOR REFERENCE ONLY.

P.C. BOARD THICKNESS	DIM. "D" (MTG. PEGS)	DIM. "F" (P.C. TAILS)
.062/(1.57)	.128 (3.25)	.120 +.015/-.025 (3.05 +.38/-.63)
.125/(3.18)	.191 (4.85)	.205 +.015/-.025 (5.21 +.38/-.63)

CONNECTOR SIZE	CIRCUIT SIZE	DIM. "G"
8	8	.350 (8.89)
8	6	.250 (6.35)
8	4	.150 (3.81)
8	2	.050 (1.27)

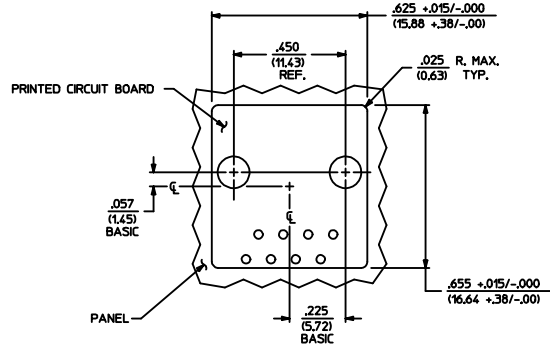
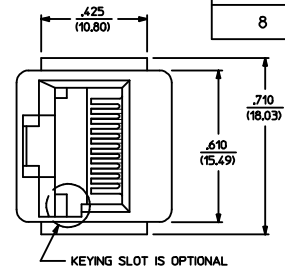

PANEL CUT-OUT FOR CONNECTOR SIZE 8

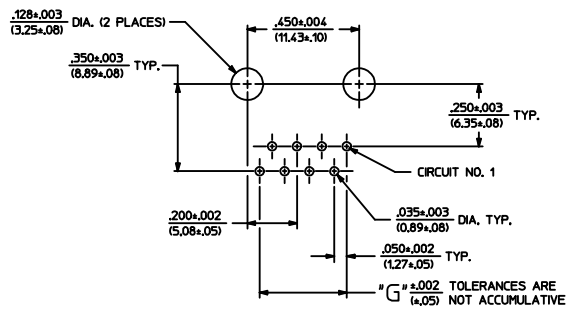

P.C. BOARD LAYOUT FOR CONNECTOR SIZE 8  
VIEWED FROM COMPONENT SIDE

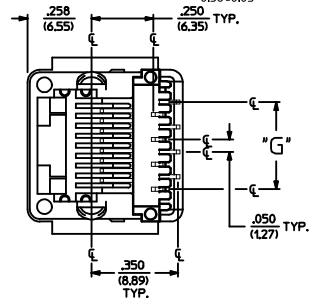
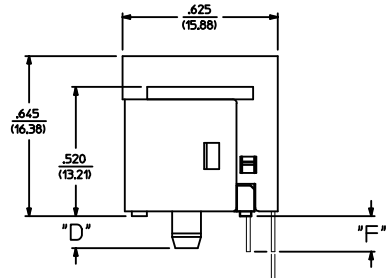
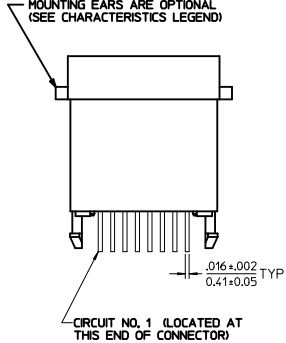

SIZE 8 MODULAR JACK LOADED WITH 8 TERMINALS SHOWN ABOVE  
(SEE SHEET 4 FOR PART NUMBER AVAILABILITY)

SEE SHEET 1 IEC NO: UCP2015-2536 DRAWING NO: 2015/02/24 CHKD: BELL APPR: FSM TH 2015/03/24	QUALITY SYMBOLS	GENERAL TOLERANCES (UNLESS SPECIFIED)	DIMENSION STYLE	SCALE	DESIGN UNITS	THIRD ANGLE PROJECTION
	∇=0 ∇=0 ∇=0	mm INCH 4 PLACES ± --- ± --- 3 PLACES ± --- ± .010 2 PLACES ± 0.25 ± --- 1 PLACE ± --- ± --- 0 PLACE ± ± ---	IN/MM DRAWN BY DATE CHECKED BY DATE BAP 1990/10/12 APPROVED BY DATE FSMITH 2012/02/14	4:1	INCH	ASSEMBLY; VERTICAL MODULAR JACKS
	ANGULAR ±1/2° DRAFT WHERE APPLICABLE MUST REMAIN WITHIN DIMENSIONS	MATERIAL NO. SEE SHEET 4	DOCUMENT NO. SDA-42410-****	molex		
	SIZE D	THIS DRAWING CONTAINS INFORMATION THAT IS PROPRIETARY TO MOLEX INCORPORATED AND SHOULD NOT BE USED WITHOUT WRITTEN PERMISSION				

SIZE 4 VERTICAL MODJACK ASSEMBLIES					
PART CHARACTERISTICS					
ASSEMBLY ITEM NUMBER	EXTERNAL CONNECTOR SIZE	NUMBER OF POSITIONS	P.C. BOARD THICKNESS	MOUNTING EARS OPTION	TERMINAL PLATING OPTION
42410-4168	4 POS. BODY	4	.062/(1.57)	YES	A
42410-4170	↑	↑	.062/(1.57)	NO	A
42410-4264	↓	↓	.125/(3.18)	YES	A
42410-4266	4 POS. BODY	4	.125/(3.18)	NO	A
42410-4312	4 POS. BODY	2	.062/(1.57)	YES	A
42410-4314	↑	↑	.062/(1.57)	NO	A
42410-4408	↓	↓	.125/(3.18)	YES	A
42410-4410	4 POS. BODY	2	.125/(3.18)	NO	A

SIZE 6 VERTICAL MODJACK ASSEMBLIES					
PART CHARACTERISTICS					
ASSEMBLY ITEM NUMBER	EXTERNAL CONNECTOR SIZE	NUMBER OF POSITIONS	P.C. BOARD THICKNESS	MOUNTING EARS OPTION	TERMINAL PLATING OPTION
42410-6168	6 POS. BODY	6	.062/(1.57)	YES	A
42410-6170	↑	↑	.062/(1.57)	NO	A
42410-6264	↓	↓	.125/(3.18)	YES	A
42410-6266	6 POS. BODY	6	.125/(3.18)	NO	A
42410-6312	6 POS. BODY	4	.062/(1.57)	YES	A
42410-6314	↑	↑	.062/(1.57)	NO	A
42410-6320	↓	↓	.062/(1.57)	YES	B
42410-6408	↓	↓	.125/(3.18)	YES	A
42410-6410	6 POS. BODY	4	.125/(3.18)	NO	A
42410-6456	6 POS. BODY	2	.062/(1.57)	YES	A
42410-6458	↑	↑	.062/(1.57)	NO	A
42410-6552	↓	↓	.125/(3.18)	YES	A
42410-6554	6 POS. BODY	2	.125/(3.18)	NO	A

SIZE 8 VERTICAL MODJACK ASSEMBLIES						
PART CHARACTERISTICS						
ASSEMBLY ITEM NUMBER	EXTERNAL CONNECTOR SIZE	NUMBER OF POSITIONS	P.C. BOARD THICKNESS	KEYING OPTION	MOUNTING EARS OPTION	TERMINAL PLATING OPTION
42410-8312	8 POS. BODY	8	.062/(1.57)	NO	YES	A
42410-8314	↑	↑	.062/(1.57)	NO	NO	A
42410-8360	↓	↓	.062/(1.57)	YES	YES	A
42410-8362	↓	↓	.062/(1.57)	YES	NO	A
42410-8504	↓	↓	.125/(3.18)	NO	YES	A
42410-8506	↓	↓	.125/(3.18)	NO	NO	A
42410-8552	↓	↓	.125/(3.18)	YES	YES	A
42410-8554	8 POS. BODY	8	.125/(3.18)	YES	NO	A
42410-8600	8 POS. BODY	6	.062/(1.57)	NO	YES	A
42410-8602	↑	↑	.062/(1.57)	NO	NO	A
42410-8648	↑	↑	.062/(1.57)	YES	YES	A
42410-8650	↑	↑	.062/(1.57)	YES	NO	A
42410-8792	↓	↓	.125/(3.18)	NO	YES	A
42410-8794	↓	↓	.125/(3.18)	NO	NO	A
42410-8840	↓	↓	.125/(3.18)	YES	YES	A
42410-8842	8 POS. BODY	6	.125/(3.18)	YES	NO	A
42410-8888	8 POS. BODY	4	.062/(1.57)	NO	YES	A
42410-8890	↑	↑	.062/(1.57)	NO	NO	A
42410-8936	↑	↑	.062/(1.57)	YES	YES	A
42410-8938	↑	↑	.062/(1.57)	YES	NO	A
42410-9080	↓	↓	.125/(3.18)	NO	YES	A
42410-9082	↓	↓	.125/(3.18)	NO	NO	A
42410-9128	↓	↓	.125/(3.18)	YES	YES	A
42410-9130	8 POS. BODY	4	.125/(3.18)	YES	NO	A
42410-9176	8 POS. BODY	2	.062/(1.57)	NO	YES	A
42410-9178	↑	↑	.062/(1.57)	NO	NO	A
42410-9224	↑	↑	.062/(1.57)	YES	YES	A
42410-9226	↑	↑	.062/(1.57)	YES	NO	A
42410-9368	↓	↓	.125/(3.18)	NO	YES	A
42410-9370	↓	↓	.125/(3.18)	NO	NO	A
42410-9416	↓	↓	.125/(3.18)	YES	YES	A
42410-9418	8 POS. BODY	2	.125/(3.18)	YES	NO	A

<b>SEE SHEET 1</b> EEC NO: UCP2015-2536 DRAWN BY: NG CHKD: J.BELL APPR: F.S.M.T.H. DATE: 2015/02/24 DATE: 2015/03/24	<b>QUALITY SYMBOLS</b> ∇=0 ∇=0 ∇=0	<b>GENERAL TOLERANCES (UNLESS SPECIFIED)</b>		DIMENSION STYLE <b>IN/MM</b>	SCALE <b>1:1</b>	DESIGN UNITS <b>INCH</b>	THIRD ANGLE PROJECTION	
		4 PLACES ± .010 3 PLACES ± .010 2 PLACES ± 0.25 1 PLACE ± .010 0 PLACE ± .010	mm INCH	DATE 1990/10/12	DATE 1990/10/12	<b>ASSEMBLY: VERTICAL MODULAR JACKS</b>		
		ANGULAR ±1/2° DRAFT WHERE APPLICABLE MUST REMAIN WITHIN DIMENSIONS	MATERIAL NO. <b>SEE CHART</b>	DATE 2012/02/14	DOCUMENT NO. <b>SDA-42410-****</b>	<b>molex</b>		
		SIZE D	THIS DRAWING CONTAINS INFORMATION THAT IS PROPRIETARY TO MOLEX INCORPORATED AND SHOULD NOT BE USED WITHOUT WRITTEN PERMISSION			SHEET NO. <b>4 OF 4</b>		