

1.5A, 1000V Miniature Fast Recovery Glass Passivated Surface Bridge Rectifier

FEATURES

- Ideal for automated placement, for compact PCB design
- High surge current capability
- Ultrafast reverse recovery time for high frequency
- Negligible leakage current
- Compliant to RoHS Directive 2011/65/EU and in accordance to WEEE 2002/96/EC
- Halogen-free according to IEC 61249-2-21

MECHANICAL DATA

Case: Molded plastic body

Molding compound, UL flammability classification rating 94V-0

Moisture sensitivity: level 1, per J-STD-020

Part no. with suffix "H" means AEC-Q101 qualified

Packing code with suffix "G" means green compound (halogen-free)

Terminal: Matte tin plated leads, solderable per JESD22-B102

Meet JESD 201 class 2 whisker test

Polarity: Polarity as marked on the body

Weight: 0.09 g (approximately)

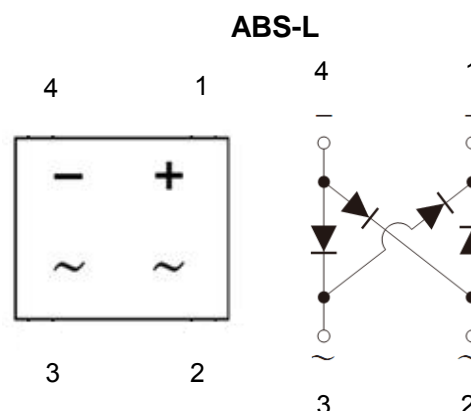

MAXIMUM RATINGS AND ELECTRICAL CHARACTERISTICS (T _A =25°C unless otherwise noted)			
PARAMETER	SYMBOL	RABS15M	UNIT
Maximum repetitive peak reverse voltage	V _{RRM}	1000	V
Maximum RMS voltage	V _{RMS}	700	V
Maximum DC blocking voltage	V _{DC}	1000	V
Maximum average forward rectified current	I _{F(AV)}	1.5	A
Peak forward surge current, 8.3 ms single half sine-wave superimposed on rated load	I _{FSM}	50	A
Maximum instantaneous forward voltage (Note 1) I _F = 1.5A	V _F	1.30	V
Maximum reverse current @ rated V _R T _J =25°C T _J =125°C	I _R	1	μA
		200	
Maximum reverse recovery time per diode (Note 2)	t _{rr}	500	ns
Rating for fusing (t<8.3ms)	I ² t	10	A ² s
Typical thermal resistance	R _{θJL}	26	°C/W
	R _{θJA}	70	
Operating junction temperature range	T _J	- 55 to +150	°C
Storage temperature range	T _{STG}	- 55 to +150	°C

Note 1: Pulse test with PW=300μs, 1% duty cycle

Note 2: Reverse Recovery Test Conditions: I_F=0.5A, I_R=1.0A, I_{RR}=0.25A

ORDERING INFORMATION

PART NO.	PART NO. SUFFIX	PACKING CODE	PACKING CODE SUFFIX	PACKAGE	PACKING
RABS15M (Note 1)	H	RE	G	ABS-L	1,000 / 7" Plastic reel
		RG		ABS-L	5,000 / 13" Paper reel

Note 1: Whole series with green compound

EXAMPLE

PREFERRED P/N	PART NO.	PART NO. SUFFIX	PACKING CODE	PACKING CODE SUFFIX	DESCRIPTION
RABS15MHREG	RABS15M	H	RE	G	AEC-Q101 qualified Green compound

RATINGS AND CHARACTERISTICS CURVES

($T_A=25^\circ\text{C}$ unless otherwise noted)

FIG.1 MAXIMUM FORWARD CURRENT DERATING CURVE

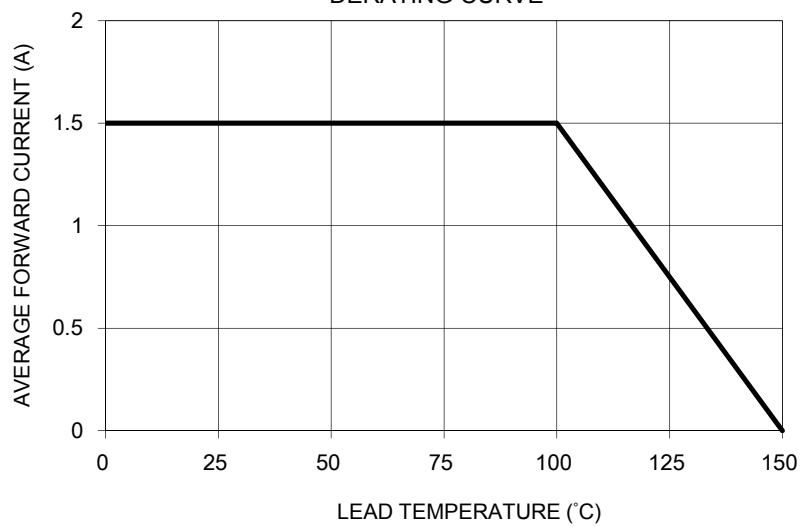

FIG. 2 TYPICAL REVERSE CHARACTERISTICS

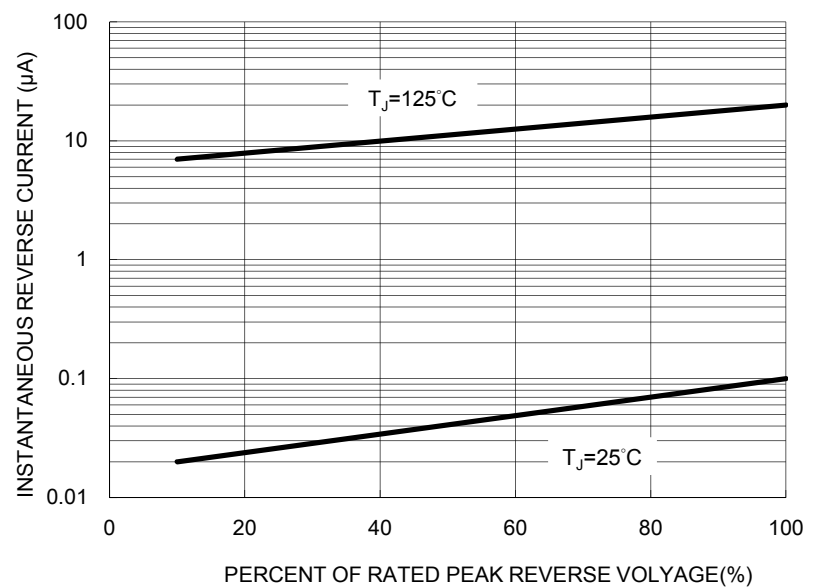

FIG. 3 MAXIMUM NON-REPETITIVE FORWARD SURGE CURRENT

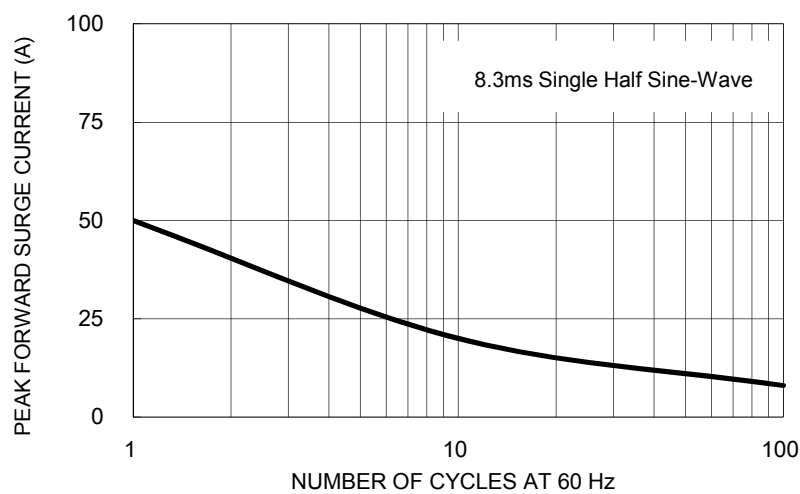

FIG. 4 TYPICAL JUNCTION CAPACITANCE

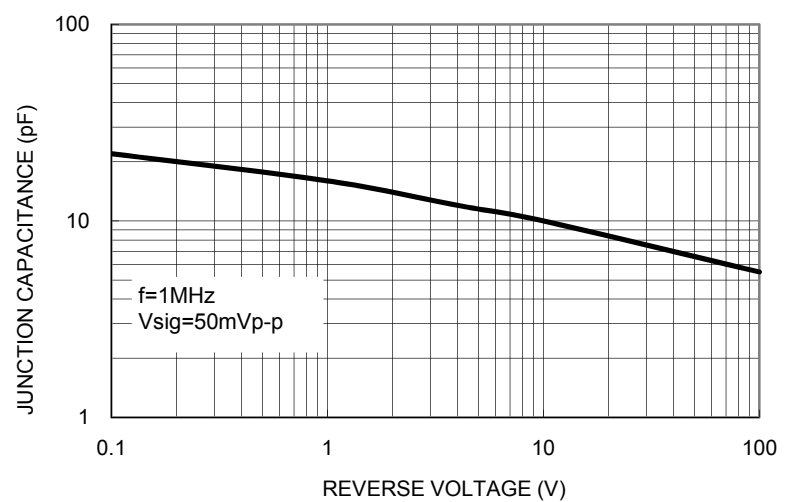
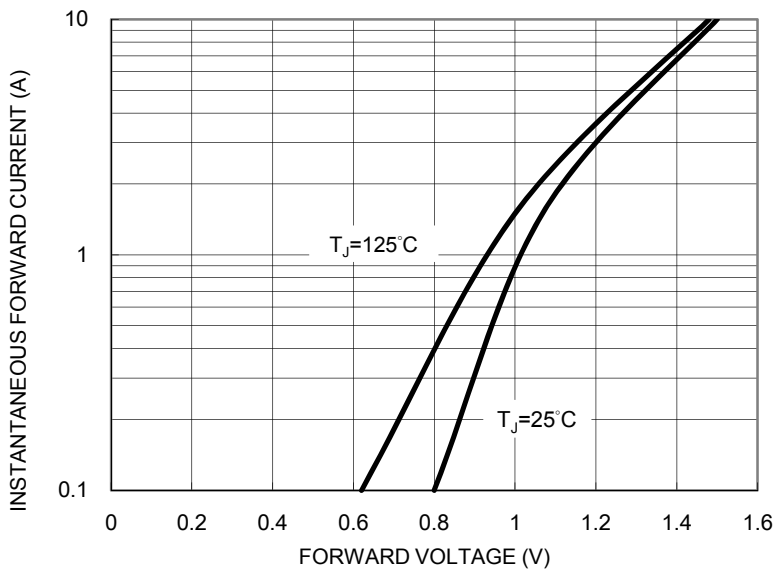
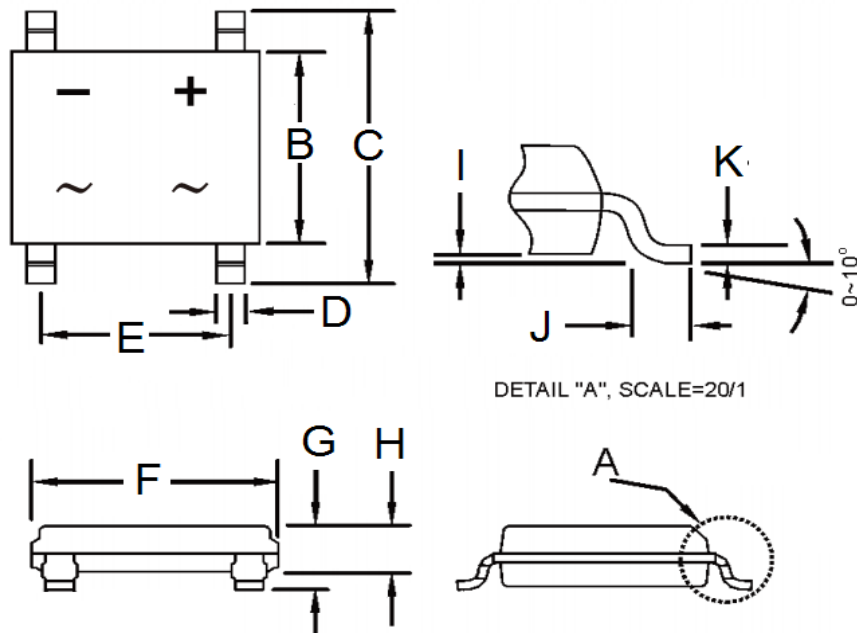

FIG. 5 TYPICAL FORWARD CHARACTERISTICS



PACKAGE OUTLINE DIMENSIONS

ABS-L



DIM.	Unit (mm)		Unit (inch)	
	Min	Max	Min	Max
B	4.30	4.50	0.169	0.177
C	6.25	6.65	0.246	0.262
D	0.60	0.70	0.024	0.028
E	3.90	4.10	0.154	0.161
F	4.90	5.10	0.193	0.201
G	1.25	1.35	0.049	0.053
H	1.20	1.30	0.047	0.051
I	0.05	0.15	0.002	0.006
J	0.30	0.70	0.012	0.028
K	0.15	0.25	0.006	0.010

SUGGESTED PAD LAYOUT

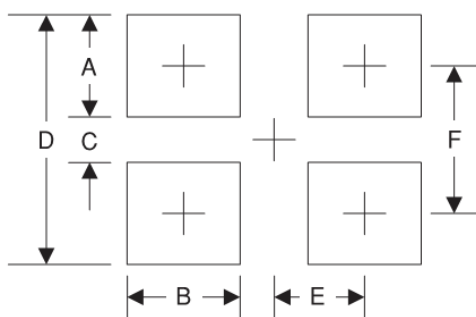

Symbol	Unit (mm)	Unit (inch)
A	1.50	0.059
B	0.90	0.035
C	4.22	0.166
D	7.22	0.284
E	2.05	0.081
F	5.72	0.225

MARKING DIAGRAM



P/N = Specific Device Code
 YW = Date Code
 F = Factory Code

Notice

Specifications of the products displayed herein are subject to change without notice. TSC or anyone on its behalf, assumes no responsibility or liability for any errors or inaccuracies.

Information contained herein is intended to provide a product description only. No license, express or implied, to any intellectual property rights is granted by this document. Except as provided in TSC's terms and conditions of sale for such products, TSC assumes no liability whatsoever, and disclaims any express or implied warranty, relating to sale and/or use of TSC products including liability or warranties relating to fitness for a particular purpose, merchantability, or infringement of any patent, copyright, or other intellectual property right.

The products shown herein are not designed for use in medical, life-saving, or life-sustaining applications. Customers using or selling these products for use in such applications do so at their own risk and agree to fully indemnify TSC for any damages resulting from such improper use or sale.