

FEATURES

Nonreflective 50 Ω design

Positive control range: 0 V to 3.3 V

Low insertion loss: 0.8 dB at 8.0 GHz

High isolation: 34 dB at 8.0 GHz

High power handling

33 dBm through path

27 dBm termination path

High linearity

1 dB compression (P1dB): 37 dBm typical

Input third-order intercept (IIP3): 58 dBm typical at 8.0 GHz

ESD rating: 4 kV human body model (HBM)

4 mm \times 4 mm, 24-lead LFCSP package

No low frequency spurious

RF settling time (0.05 dB margin of final RF_{OUT}): 9 μ s

APPLICATIONS

Test instrumentation

Microwave radios and very small aperture terminals (VSATs)

Military radios, radars, and electronic counter measures (ECMs)

Fiber optics and broadband telecommunications

GENERAL DESCRIPTION

The **ADRF5040** is a general-purpose, broadband high isolation, nonreflective single-pole, quad-throw (SP4T) switch in an LFCSP surface-mount package. Covering the 9 kHz to 12.0 GHz range, the switch offers high isolation and low insertion loss. The switch features 34 dB isolation and 0.8 dB insertion loss up to

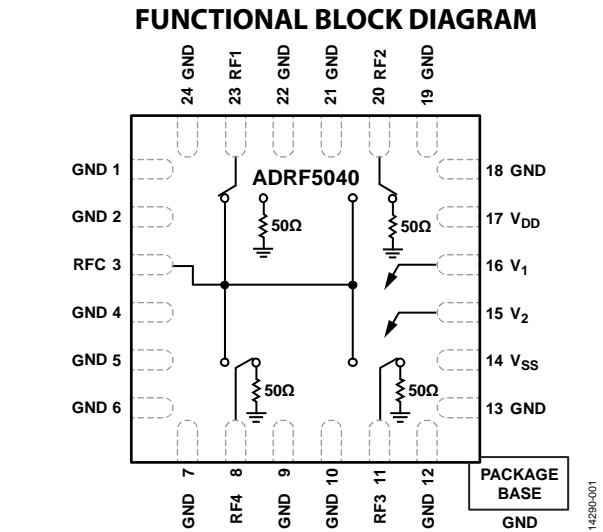

8.0 GHz, and a 9 μ s settling time of 0.05 dB margin of the final radio frequency output (RF_{OUT}). The switch operates using positive control voltage of 3.3 V and 0 V and requires +3.3 V and -3.3 V supplies. The **ADRF5040** is packaged in a 4 mm \times 4 mm, surface-mount LFCSP package.

ADRF5040* PRODUCT PAGE QUICK LINKS

Last Content Update: 02/23/2017

COMPARABLE PARTS

View a parametric search of comparable parts.

EVALUATION KITS

- ADRF5040 Evaluation Board

DOCUMENTATION

Data Sheet

- ADRF5040: High Isolation, Silicon SP4T, Nonreflective Switch, 9 kHz to 12.0 GHz Data Sheet

TOOLS AND SIMULATIONS

- ADRF5040 S-parameters

DESIGN RESOURCES

- ADRF5040 Material Declaration
- PCN-PDN Information
- Quality And Reliability
- Symbols and Footprints

DISCUSSIONS

View all ADRF5040 EngineerZone Discussions.

SAMPLE AND BUY

Visit the product page to see pricing options.

TECHNICAL SUPPORT

Submit a technical question or find your regional support number.

DOCUMENT FEEDBACK

Submit feedback for this data sheet.

TABLE OF CONTENTS

Features	1	Interface Schematics	7
Applications.....	1	Typical Performance Characteristics	8
Functional Block Diagram	1	Insertion Loss, Return Loss, and Isolation	8
General Description	1	Input Power Compression and Input Third-Order Intercept ...	10
Revision History	2	Input Power Compression and Input Third-Order Intercept,	
Specifications.....	3	10 kHz to 1 GHz	11
Electrical Specifications.....	3	Theory of Operation	12
Digital Control Voltage Specifications.....	4	Applications Information	13
Bias and Supply Current Specifications.....	4	Evaluation Board	13
Absolute Maximum Ratings.....	5	Outline Dimensions	14
ESD Caution.....	5	Ordering Guide	14
Pin Configuration and Function Descriptions.....	6		

REVISION HISTORY

2/2017—Rev. 0 to Rev. A
 Changes to Ordering Guide 14

7/2016—Revision 0: Initial Version

SPECIFICATIONS

ELECTRICAL SPECIFICATIONS

$V_{DD} = 3.3\text{ V}$, $V_{SS} = -3.3\text{ V}$, V_1 and $V_2 = 0\text{ V}$ or V_{DD} , $T_A = 25^\circ\text{C}$, $50\ \Omega$ system, unless otherwise noted.

Table 1.

Parameter	Test Conditions/Comments	Min	Typ	Max	Unit	
INSERTION LOSS	9 kHz to 4.0 GHz		0.7		dB	
	9 kHz to 8.0 GHz		0.8		dB	
	9 kHz to 10.0 GHz		1.1		dB	
	9 kHz to 12.0 GHz		2		dB	
ISOLATION, RFC TO RF1 TO RF4 (WORST CASE)	9 kHz to 4.0 GHz		44		dB	
	9 kHz to 8.0 GHz		34		dB	
	9 kHz to 10.0 GHz		29.2		dB	
	9 kHz to 12.0 GHz		20		dB	
RETURN LOSS	On State	9 kHz to 4.0 GHz	21		dB	
		9 kHz to 8.0 GHz	19		dB	
		9 kHz to 10.0 GHz	13.5		dB	
		9 kHz to 12.0 GHz	8		dB	
	Off State	9 kHz to 4.0 GHz	25		dB	
		9 kHz to 8.0 GHz	18.6		dB	
		9 kHz to 10.0 GHz	15.5		dB	
		9 kHz to 12.0 GHz	14.5		dB	
RADIO FREQUENCY (RF) SETTLING TIME	50% V_1/V_2 to 0.05 dB margin of final RF_{OUT}		9		μs	
	50% V_1/V_2 to 0.1 dB margin of final RF_{OUT}		7		μs	
SWITCHING SPEED	10% to 90% RF_{OUT}		1.3		μs	
	50% V_1/V_2 to 90%/10% RF		3.5		μs	
INPUT POWER	9 kHz to 12.0 GHz					
	1 dB Compression (P1dB)		37		dBm	
	0.1 dB Compression (P0.1dB)		34		dBm	
INPUT THIRD-ORDER INTERCEPT (IIP3)	Two-tone input power = 14 dBm at each tone					
	1 MHz to 2.0 GHz		62		dBm	
	1 MHz to 8.0 GHz		58		dBm	
	1 MHz to 12.0 GHz		53		dBm	
RECOMMENDED OPERATING CONDITIONS	Positive Supply Voltage (V_{DD})		3.0	3.6	V	
	Negative Supply Voltage (V_{SS})		-3.6	-3.0	V	
	Control Voltage (V_1, V_2) Range		0	V_{DD}	V	
	RF Input Power	$V_{DD} = 3.3\text{ V}$, $V_{SS} = -3.3\text{ V}$, $T_A = 85^\circ\text{C}$, frequency = 2 GHz				
	Through Path			33	dBm	
	Termination Path			27	dBm	
	Hot Switch Power Level	$V_{DD} = 3.3\text{ V}$, $T_A = 85^\circ\text{C}$, frequency = 2 GHz		27		dBm
Case Temperature Range (T_{CASE})		-40		+85	$^\circ\text{C}$	

DIGITAL CONTROL VOLTAGE SPECIFICATIONS

$V_{DD} = 3.3\text{ V} \pm 10\%$, $V_{SS} = -3.3\text{ V} \pm 10\%$, $T_{CASE} = -40^{\circ}\text{C}$ to $+85^{\circ}\text{C}$, unless otherwise noted.

Table 2.

Parameter	Symbol	Min	Typ	Max	Unit	Test Condition/Comments
INPUT CONTROL VOLTAGE (V_1, V_2)						<1 μA typical
Low	V_{IL}	0		0.8	V	
High	V_{IH}	1.4		$V_{DD} + 0.3$	V	

BIAS AND SUPPLY CURRENT SPECIFICATIONS

$T_{CASE} = -40^{\circ}\text{C}$ to $+85^{\circ}\text{C}$, unless otherwise noted.

Table 3.

Parameter	Symbol	Min	Typ	Max	Unit
SUPPLY CURRENT					
$V_{DD} = 3.3\text{ V}$	I_{DD}		20	100	μA
$V_{SS} = -3.3\text{ V}$	I_{SS}		20	100	μA

ABSOLUTE MAXIMUM RATINGS

Table 4.

Parameter	Rating
Positive Supply Voltage (V_{DD}) Range	-0.3 V to +3.7 V
Negative Supply Voltage (V_{SS}) Range	-3.7 V to +0.3 V
Control Voltage (V_1, V_2) Range	-0.3 V to $V_{DD} + 0.3$ V
RF Input Power ¹ ($V_{DD}, V_1, V_2 = 3.3$ V, $V_{SS} = -3.3$ V, $T_A = 85^\circ\text{C}$, Frequency = 2 GHz)	
Through Path	34 dBm
Termination Path	28 dBm
Hot Switch Power Level ($V_{DD} = 3.3$ V, $T_A = 85^\circ\text{C}$, Frequency = 2 GHz)	30 dBm
Storage Temperature Range	-65°C to +150°C
Channel Temperature	135°C
Thermal Resistance (Channel to Package Bottom)	
Through Path	83°C/W
Terminated Path	100°C/W
MSL Rating	MSL3
ESD Sensitivity	
Human Body Model (HBM)	4 kV (Class 3)
Charged Device Model (CDM)	1.25 kV

¹ For the recommended operating conditions, see Table 1.

Stresses at or above those listed under Absolute Maximum Ratings may cause permanent damage to the product. This is a stress rating only; functional operation of the product at these or any other conditions above those indicated in the operational section of this specification is not implied. Operation beyond the maximum operating conditions for extended periods may affect product reliability.

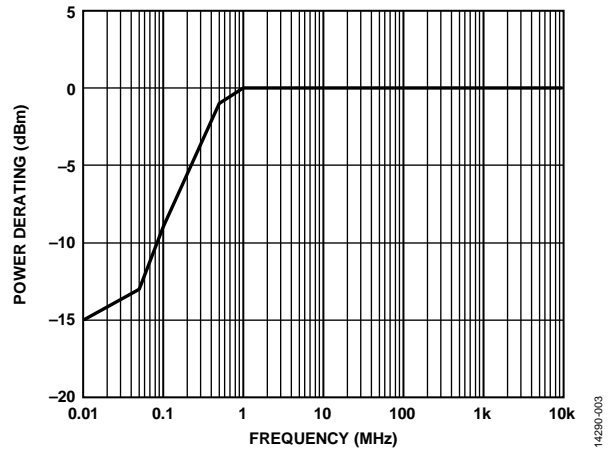

Figure 3. Power Derating for Terminated Path

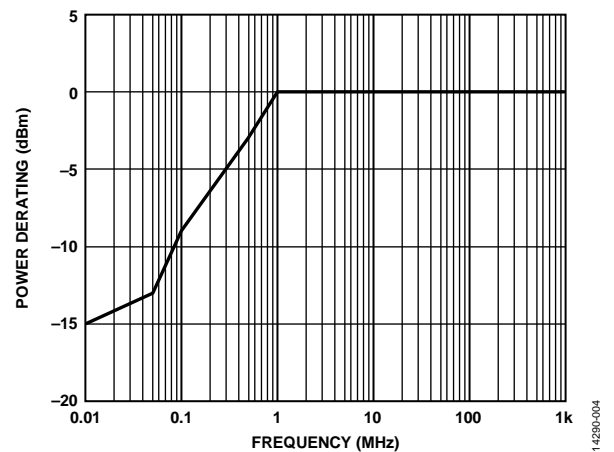

Figure 4. Power Derating for Hot Switching Power

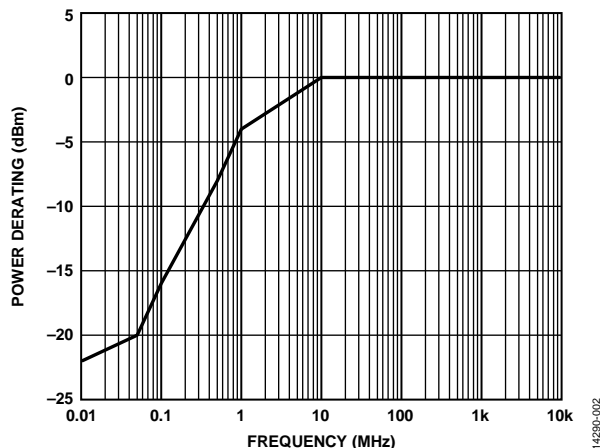

Figure 2. Power Derating for Through Path

ESD CAUTION



ESD (electrostatic discharge) sensitive device. Charged devices and circuit boards can discharge without detection. Although this product features patented or proprietary protection circuitry, damage may occur on devices subjected to high energy ESD. Therefore, proper ESD precautions should be taken to avoid performance degradation or loss of functionality.

PIN CONFIGURATION AND FUNCTION DESCRIPTIONS

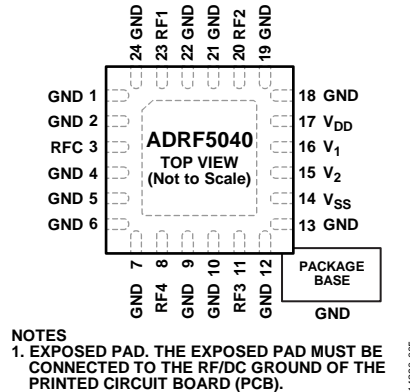

Figure 5. Pin Configuration

Table 5. Pin Function Descriptions

Pin No.	Mnemonic	Description
1, 2, 4 to 7, 9, 10, 12, 13, 18, 19, 21, 22, 24	GND	Ground. The package bottom has an exposed metal pad that must connect to the printed circuit board (PCB) RF/dc ground. See Figure 6 for the GND interface schematic.
3	RFC	RF Common Port. This pin is dc-coupled and matched to 50 Ω. A dc blocking capacitor is required if the RF line potential is not equal to 0 V dc.
8	RF4	RF4 Port. This pin is dc-coupled and matched to 50 Ω. A dc blocking capacitor is required if the RF line potential is not equal to 0 V dc.
11	RF3	RF3 Port. This pin is dc-coupled and matched to 50 Ω. A dc blocking capacitor is required if the RF line potential is not equal to 0 V dc.
14	V _{SS}	Negative Supply Voltage Pin.
15	V ₂	Control Input Pin 2. See Table 2 and Table 6.
16	V ₁	Control Input Pin 1. See Table 2 and Table 6.
17	V _{DD}	Positive Supply Voltage.
20	RF2	RF2 Port. This pin is dc-coupled and matched to 50 Ω. A dc blocking capacitor is required if the RF line potential is not equal to 0 V dc.
23	RF1	RF1 Port. This pin is dc-coupled and matched to 50 Ω. A dc blocking capacitor is required if the RF line potential is not equal to 0 V dc.
	EPAD	Exposed Pad. The exposed pad must be connected to the RF/dc ground of the PCB.

Table 6. Truth Table

Digital Control Inputs		Signal Path State
V ₁	V ₂	
Low	Low	RFC to RF1
High	Low	RFC to RF2
Low	High	RFC to RF3
High	High	RFC to RF4

INTERFACE SCHEMATICS



Figure 6. GND Interface Schematic

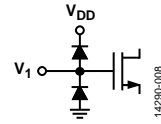

Figure 8. V1 Interface Schematic

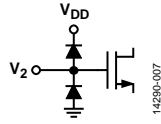

Figure 7. V2 Interface Schematic

TYPICAL PERFORMANCE CHARACTERISTICS

INSERTION LOSS, RETURN LOSS, AND ISOLATION

$V_{DD} = 3.3\text{ V}$, $V_{SS} = -3.3\text{ V}$, $T_{CASE} = 25^\circ\text{C}$, unless otherwise specified.

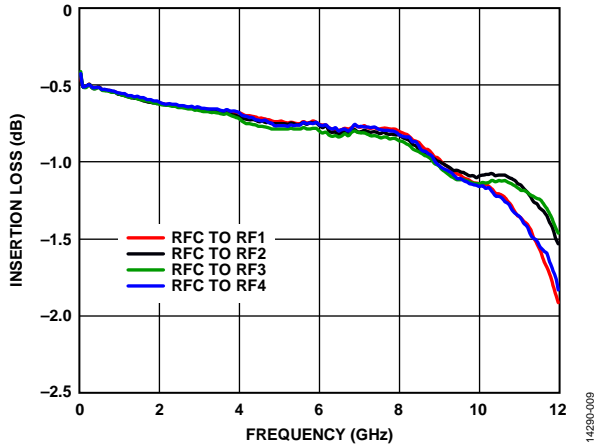

Figure 9. Insertion Loss vs. Frequency

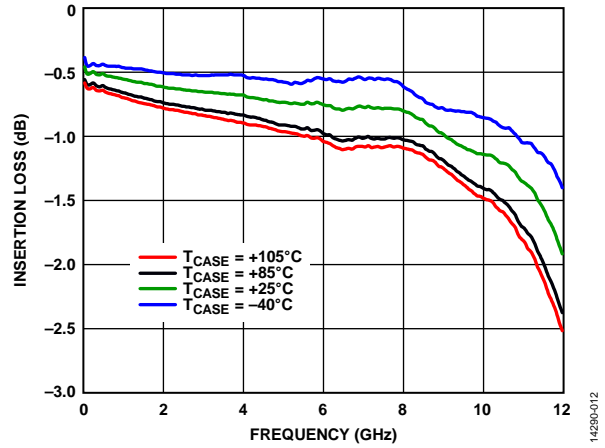

Figure 12. Insertion Loss vs. Frequency, RFC to RF1 On or RFC to RF4 On

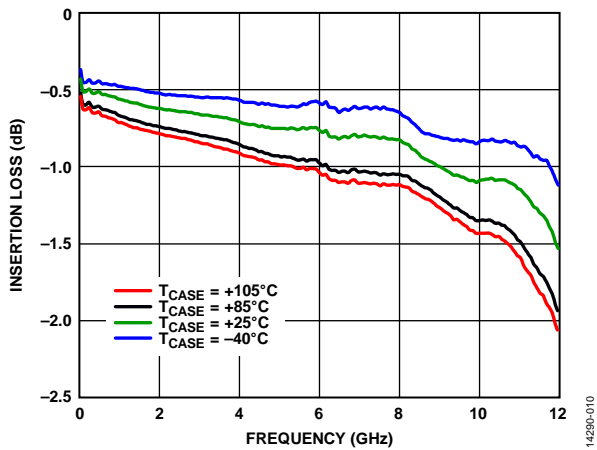

Figure 10. Insertion Loss vs. Frequency, RFC to RF2 On or RFC to RF3 On

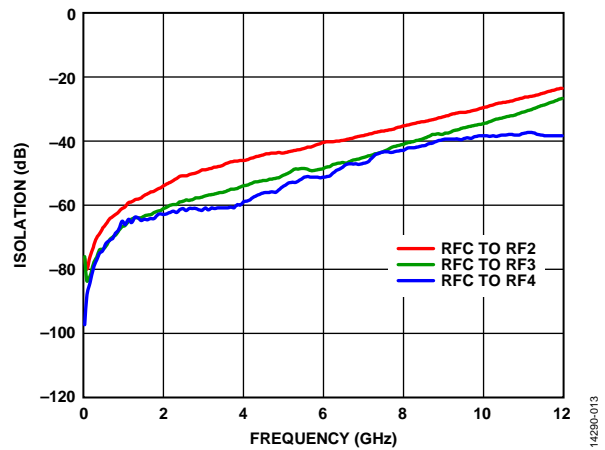

Figure 13. Isolation vs. Frequency, RFC to RF1 On

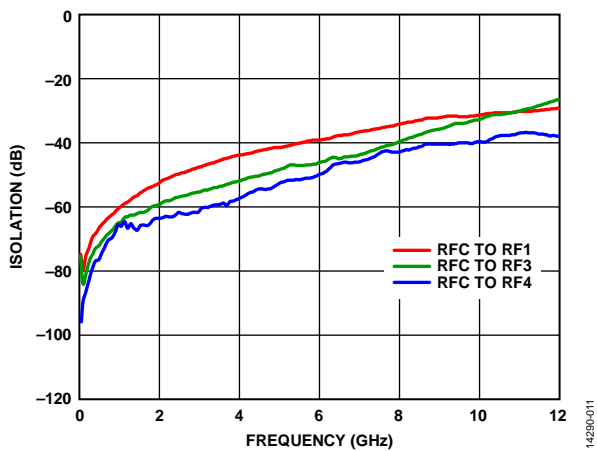

Figure 11. Isolation vs. Frequency, RFC to RF2 On

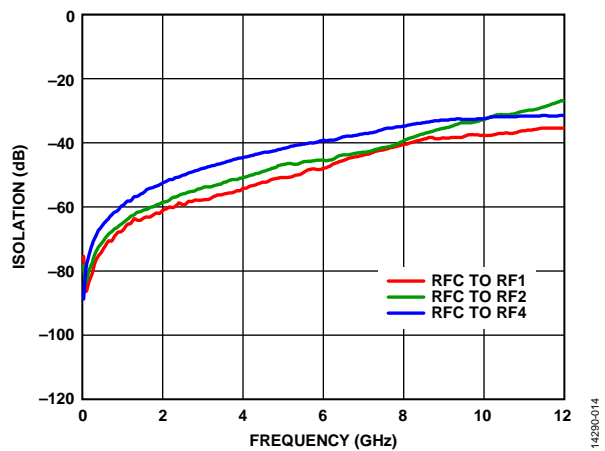

Figure 14. Isolation vs. Frequency, RFC to RF3 On

$V_{DD} = 3.3\text{ V}$, $V_{SS} = -3.3\text{ V}$, $T_{CASE} = 25^{\circ}\text{C}$, unless otherwise specified.

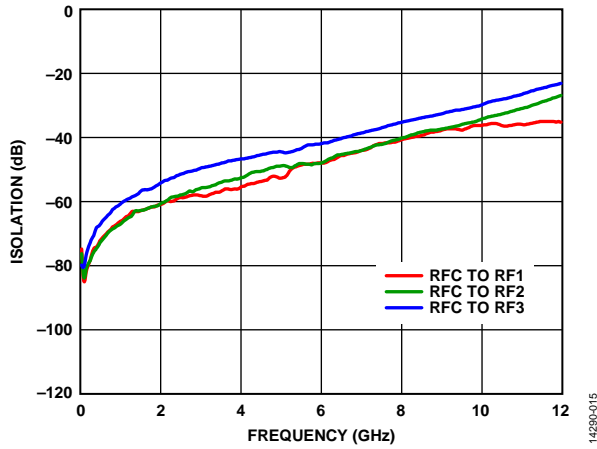

Figure 15. Isolation vs. Frequency, RFC to RF4 On

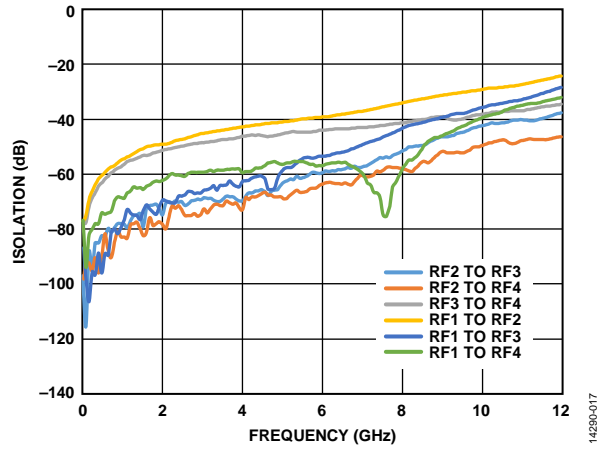

Figure 17. Channel to Channel Isolation vs. Frequency, RFC to RF1 On

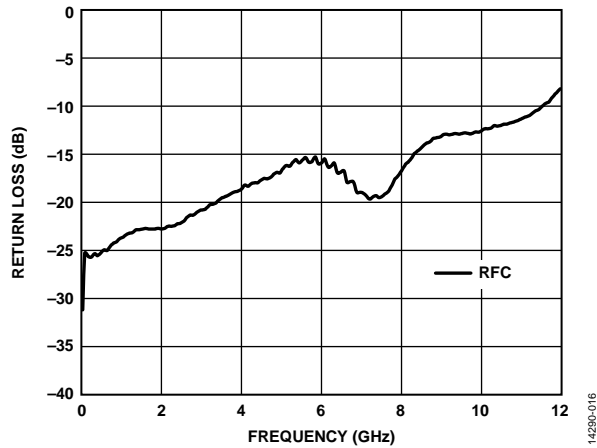

Figure 16. Return Loss vs. Frequency, RFC to RF4 On

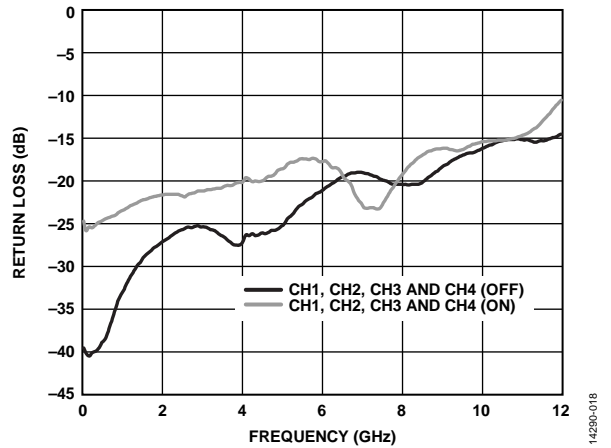

Figure 18. Return Loss vs. Frequency, RFC to RF4 On

INPUT POWER COMPRESSION AND INPUT THIRD-ORDER INTERCEPT

$V_{DD} = 3.3\text{ V}$, $V_{SS} = -3.3\text{ V}$, $T_{CASE} = 25^\circ\text{C}$, unless otherwise specified.

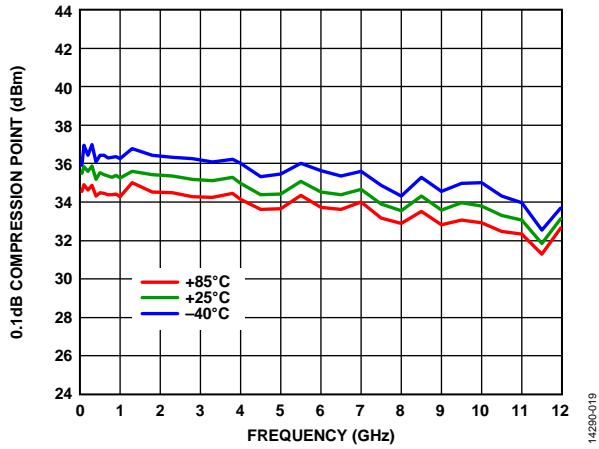

Figure 19. 0.1 dB Compression Point vs. Frequency over Temperature, $V_{DD} = 3.3\text{ V}$, $V_{SS} = -3.3\text{ V}$

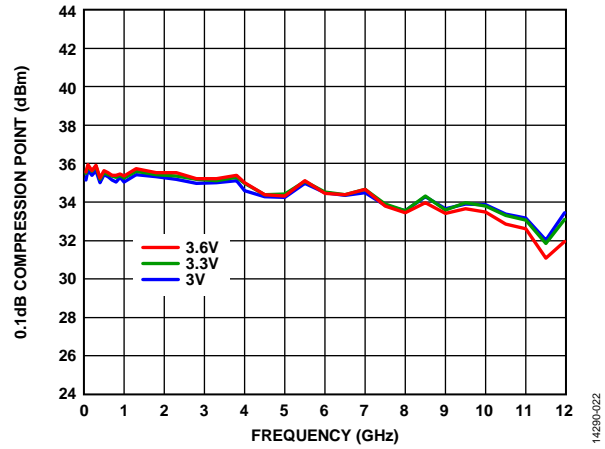

Figure 22. 0.1 dB Compression Point vs. Frequency over Voltage, $T_{CASE} = 25^\circ\text{C}$

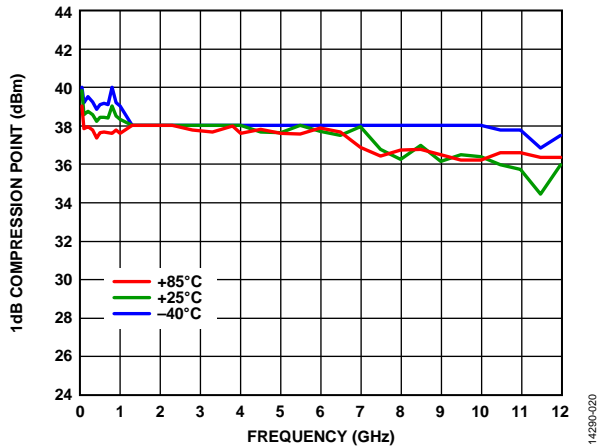

Figure 20. 1 dB Compression Point vs. Frequency over Temperature, $V_{DD} = 3.3\text{ V}$, $V_{SS} = -3.3\text{ V}$

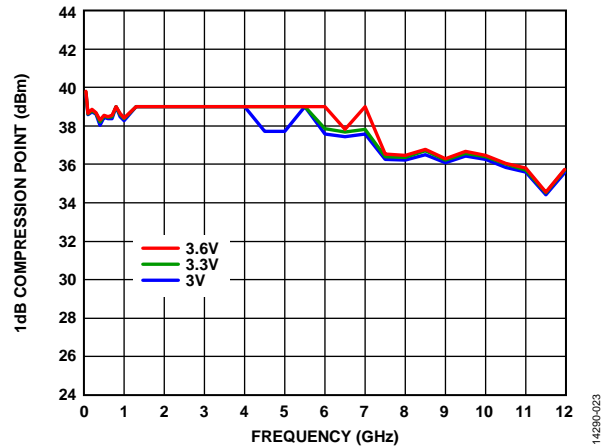

Figure 23. 1 dB Compression Point vs. Frequency over Voltage, $T_{CASE} = 25^\circ\text{C}$

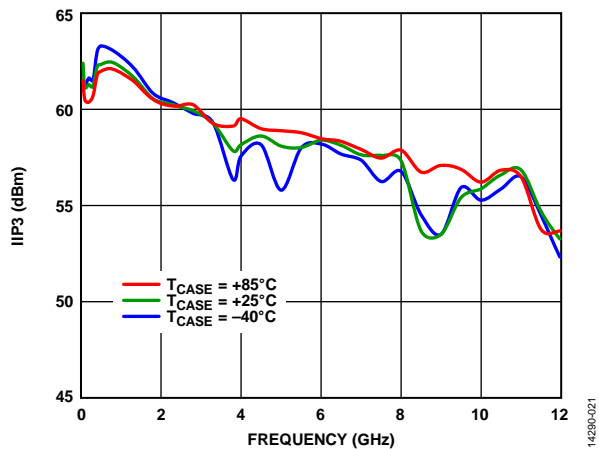

Figure 21. Input Third-Order Intercept (IIP3) vs. Frequency over Temperature, $V_{DD} = 3.3\text{ V}$, $V_{SS} = -3.3\text{ V}$

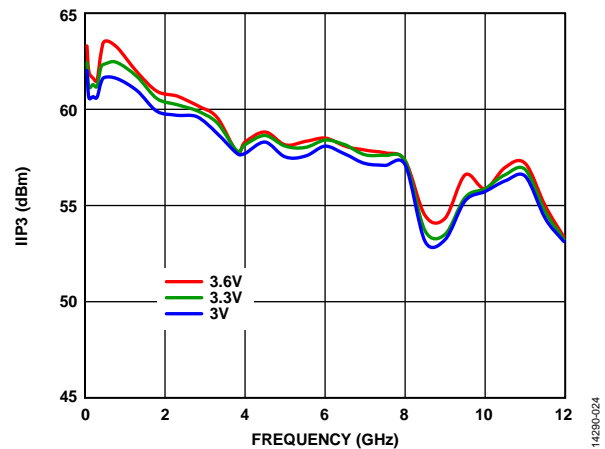

Figure 24. Input Third-Order Intercept (IIP3) vs. Frequency over Voltage, $T_{CASE} = 25^\circ\text{C}$

INPUT POWER COMPRESSION AND INPUT THIRD-ORDER INTERCEPT, 10 kHz TO 1 GHz

$V_{DD} = 3.3\text{ V}$, $V_{SS} = -3.3\text{ V}$ at $T_{CASE} = 25^{\circ}\text{C}$.

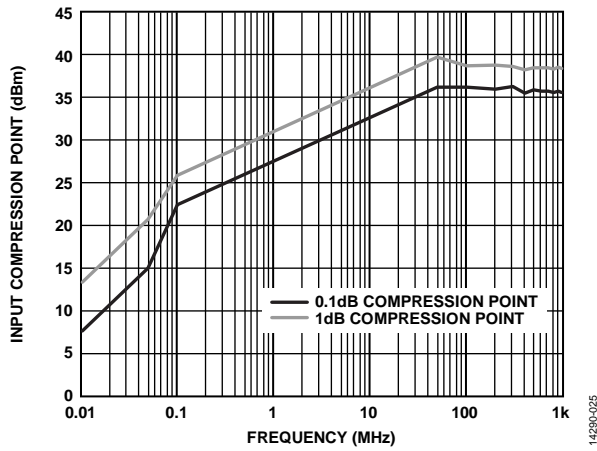

Figure 25. Input Compression Point vs. Frequency

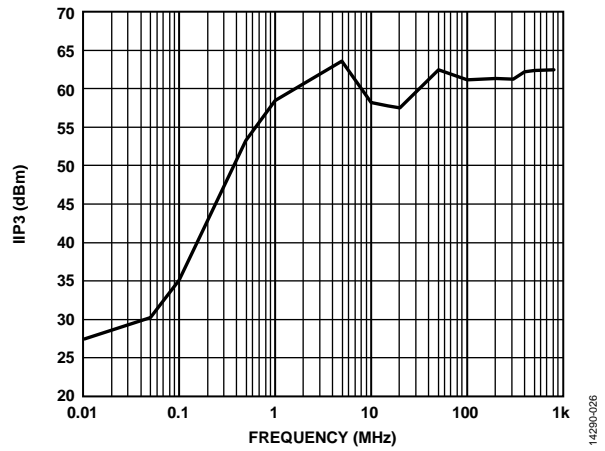

Figure 26. Input Third-Order Intercept (IIP3) vs. Frequency

THEORY OF OPERATION

The [ADRF5040](#) requires a positive supply voltage applied to the V_{DD} pin and a negative voltage supply applied to the V_{SS} pin. Bypassing capacitors are recommended on the supply lines to minimize RF coupling.

The [ADRF5040](#) is controlled via two digital control voltages applied to the V_1 pin and the V_2 pin. A small value bypassing capacitor is recommended on these digital signal lines to improve the RF signal isolation.

The [ADRF5040](#) is internally matched to $50\ \Omega$ at the RF input port (RFC) and the RF output ports (RF1, RF2, RF3, and RF4); therefore, no external matching components are required. The

RF1 through RF4 pins are dc-coupled, and dc blocking capacitors are required on the RF paths. The design is bidirectional; the input and outputs are interchangeable.

The [ADRF5040](#) does not need any special power-up sequencing, and the relative order to power up the V_{DD} and V_{SS} supplies is not important. The V_1 and V_2 control signals can be applied only after V_{DD} is powered up; this sequence avoids forward biasing and causing damage to the internal ESD protection circuits. Turn on the RF signal after the device supply settles to a steady state.

APPLICATIONS INFORMATION

EVALUATION BOARD

The [ADRF5040-EVALZ](#) evaluation board shown in Figure 27 is designed using proper RF circuit design techniques. Signal lines at the RF port have 50 Ω impedance, and the package ground

leads and backside ground slug must be connected directly to the ground plane. The evaluation board is available from Analog Devices, Inc. upon request.

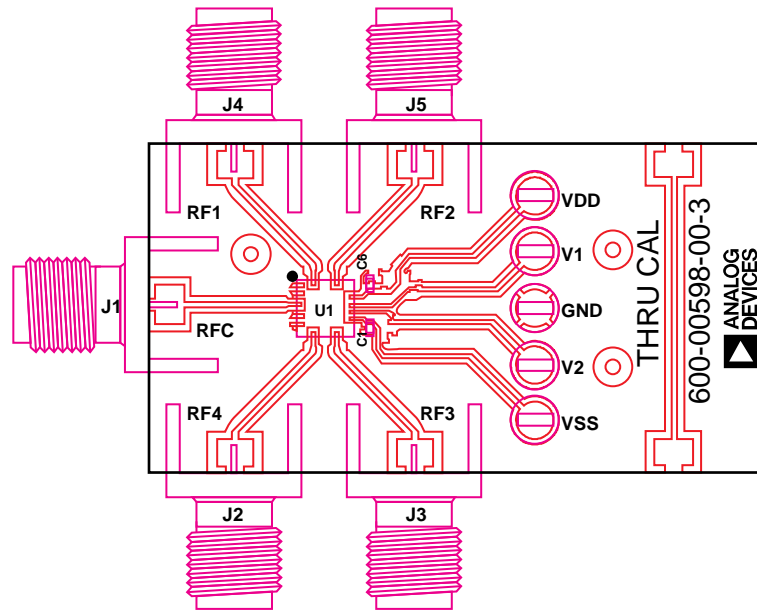

Figure 27. Evaluation PCB

14296-027

Table 7. Bill of Materials for the [ADRF5040-EVALZ](#) Evaluation Board

Item	Description
J1 to J5	PC mount SMA RF connectors
TP1 to TP5	Through hole mount test points
C1, C6	100 pF capacitors, 0402 package
U1	ADRF5040 SP4T switch
PCB	600-00598-00-3 evaluation PCB, Rogers 4350 circuit board material

OUTLINE DIMENSIONS

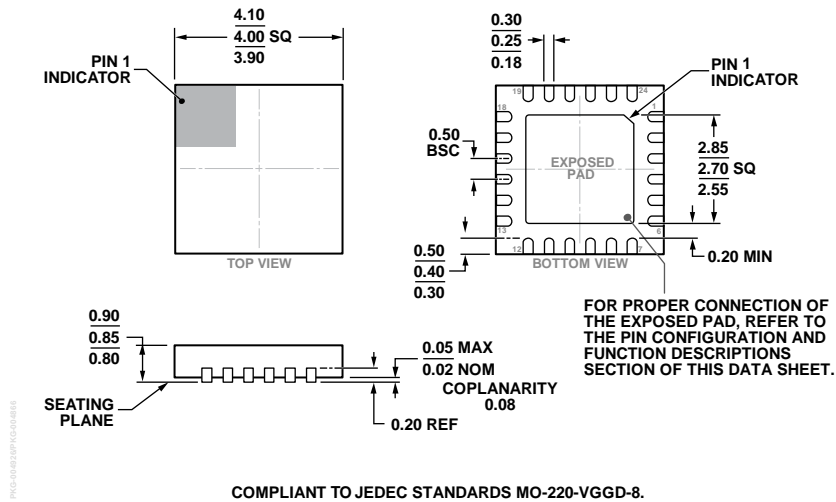

Figure 28. 24-Lead Lead Frame Chip Scale Package [LFCSP]
4 mm × 4 mm Body and 0.85 mm Package Height
(CP-24-16)
Dimensions shown in millimeters

ORDERING GUIDE

Model ¹	Temperature Range	MSL Rating ²	Package Description	Package Option	Branding ³
ADRF5040BCPZ	-40°C to +85°C	MSL3	24-Lead Lead Frame Chip Scale Package [LFCSP]	CP-24-16	ADRF 5040 #XXXXX
ADRF5040BCPZ-R7	-40°C to +85°C	MSL3	24-Lead Lead Frame Chip Scale Package [LFCSP]	CP-24-16	ADRF 5040 #XXXXX
ADRF5040-EVALZ			Evaluation Board		

¹ These models are RoHS Compliant Parts.

² See the Absolute Maximum Ratings section.

³ XXXXX is the 5-digit lot number.