

IS474

Linear Output Type OPIC Light Detector

■ Features

1. Linear output conforming to illuminance
(50 lx to 50000 lx)
2. Conforming to required visual sensitivity characteristics
by means of built-in filter
Peak sensitivity wavelength : TYP. 550 nm
3. Not dependent on kind of light source such as
incandescent lamp and fluorescent lamp
4. Easy-to-mount holder-integral side view type

■ Applications

1. TV sets
2. CRTs of personal computers and others

■ Outline Dimensions

(Unit : mm)

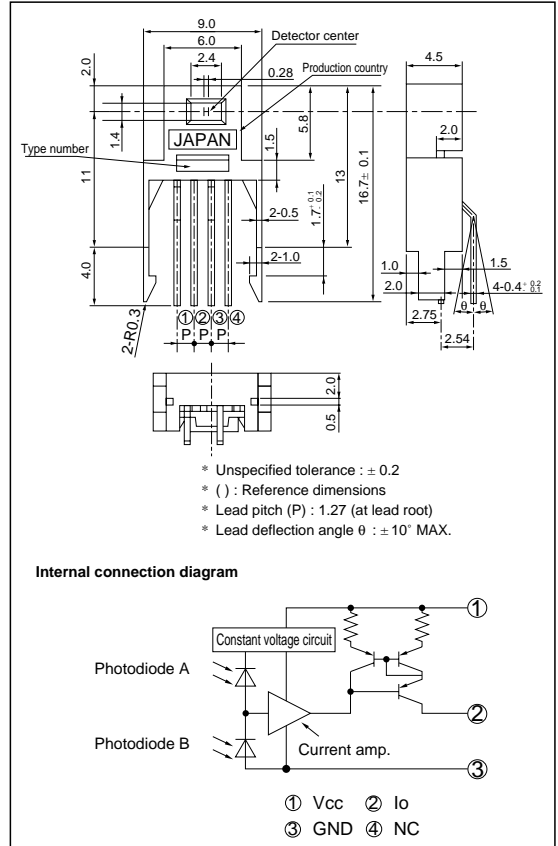

* OPIC (Optical IC) is a trademark of SHARP corporation. An OPIC consists of a light-detecting element and signal-processing circuit integrated onto a single chip.

■ Absolute Maximum Ratings

(Ta=25°C)

| Parameter | Symbol | Rating | Unit |
|-------------------------------------|------------------|-------------------------|------|
| Supply voltage | V _{CC} | -0.5 to 8 | V |
| Output current | I _O | -10 | mA |
| Output voltage | V _O | -0.5 to V _{CC} | V |
| Power dissipation | P | 150 | mW |
| Operating temperature | T _{opr} | -25 to +85 | °C |
| Storage temperature | T _{stg} | -40 to +85 | °C |
| ^{*1} Soldering temperature | T _{sol} | 260 | °C |

*1 For MAX. 3 seconds at the position shown in the right drawing

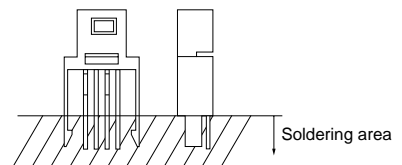

Recommended Operating Conditions

| Parameter | Symbol | MIN. | MAX. | Unit |
|-----------------------|-----------|------|----------------|------|
| Supply voltage | V_{CC} | 4.5 | 5.5 | V |
| Illuminance | E_v *1 | 100 | 50 000 | lx |
| Output voltage | V_o | 0 | $V_{CC} - 1.5$ | V |
| Operating temperature | T_{opr} | - 10 | 70 | °C |

*1 CIE standard light source A (tungsten lamp)

Electro-optical Characteristics

($V_{CC}=5V, T_a=25^\circ C$)

| Parameter | Symbol | Conditions | MIN. | TYP. | MAX. | Unit | Test circuit |
|---------------------------------------|-------------|---|-------|-------|-------|---------|--------------|
| Supply current | I_{CC} | *1 $E_v = 0$ lx | 0.2 | 0.55 | 1.0 | mA | 1 |
| Output current 1 | I_{O1} | *1 $E_v = 100$ lx | - 6.0 | - 10 | - 14 | μA | 2 |
| Output current 2 | I_{O2} | *1 $E_v = 1000$ lx | - 60 | - 100 | - 140 | μA | 2 |
| Output current ratio 1 | RI_{O1} | I_{O2}/I_{O1} | 9.0 | 10 | 11 | - | - |
| Output current 3 | I_{O3} | *2 $E_v = 100$ lx | - | - 11 | - | μA | 2 |
| Output current 4 | I_{O4} | *3 $E_v = 100$ lx | - | - 10 | - | μA | 2 |
| Output current ratio 2 | RI_{O2} | I_{O3}/I_{O4} | (0.9) | (1.1) | (1.3) | - | - |
| Dark output current | I_{od} | *1 $E_v = 0$ lx | - | - 10 | - 500 | nA | 2 |
| Peak sensitivity wavelength | λ_p | - | - | (550) | - | nm | - |
| Response time (rise) | t_r | $R_L = 3.3k\Omega$ | - | 12 | - | μs | 3 |
| Response time (fall) | t_f | $R_L = 3.3k\Omega$ | - | 30 | - | μs | 3 |
| Power source fluctuation removability | PSRR1 | $E_v = 0$ lx $R_L = 3.3k\Omega$ at 10kHz | - | 48 | - | dB | - |
| | PSRR2 | $E_v = 0$ lx $R_L = 3.3k\Omega$ at 100kHz | - | 39 | - | dB | - |
| | PSRR3 | $E_v = 1000$ lx $R_L = 3.3k\Omega$ at 10kHz | - | 11 | - | dB | - |

*4

*1 Illuminance by CIE standard light source A (tungsten lamp)

*2 Illuminance by incandescent lamp

*3 Illuminance by fluorescent lamp

*4 Power source fluctuation removability PSRR is defined according to the following formula.

$$PSRR = 20 \log \frac{V_{CC} \text{ ripple voltage}}{V_o \text{ ripple voltage}}$$

Test circuit 1

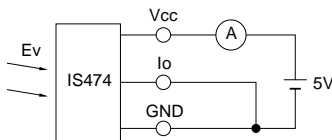

Test circuit 2

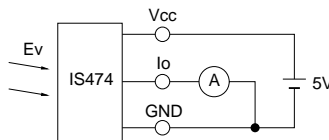

Test circuit 3

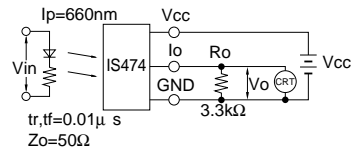

$T = 500 \mu s$
Adjust V_{in} so that V_o waveform may be of 1.0V amplitude

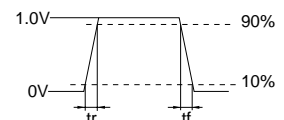

Fig. 1 Total Power Dissipation vs. Ambient Temperature

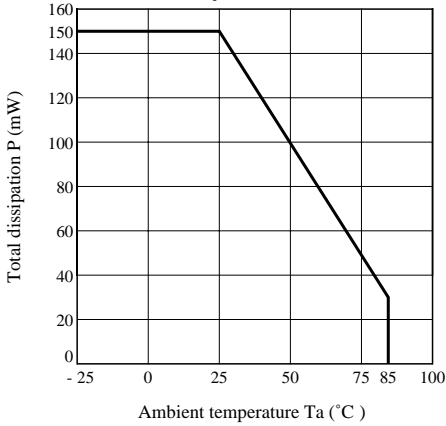

Fig. 2 Output Current vs. Illuminance

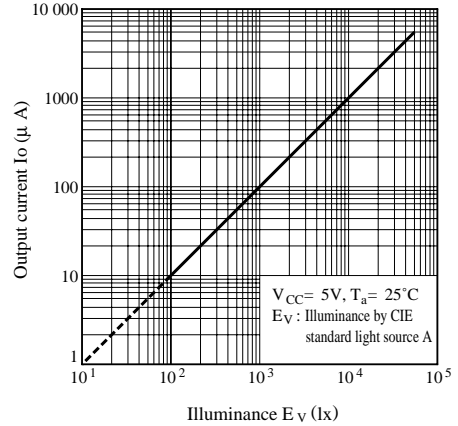

Fig. 3 Spectral Sensitivity

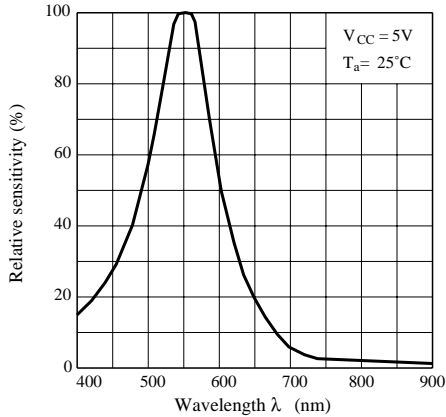

Fig. 4 Relative Output Current vs. Ambient Temperature

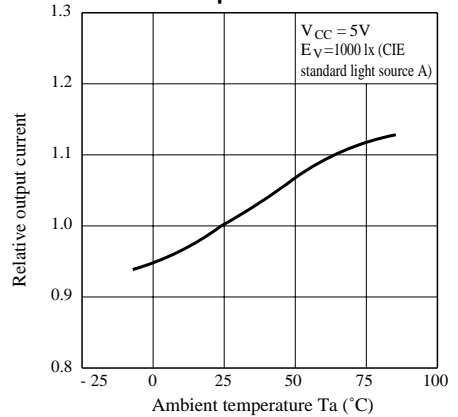

Fig. 5 Dark Output Current vs. Ambient Temperature

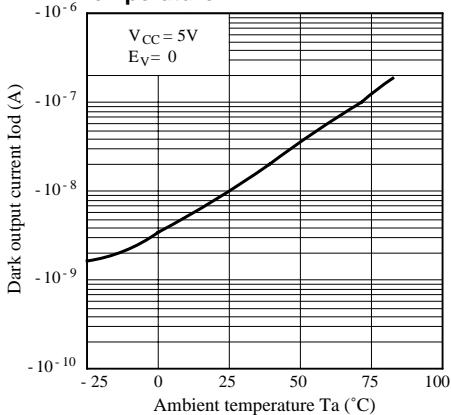

Fig. 6 Output Current vs. Supply Voltage

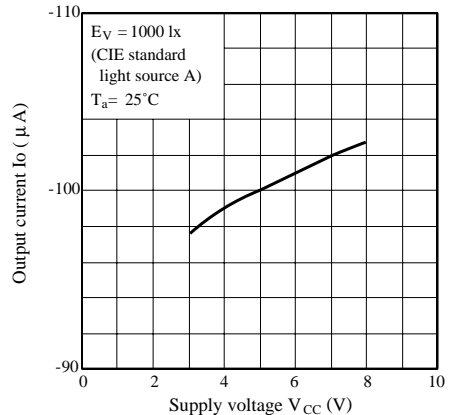
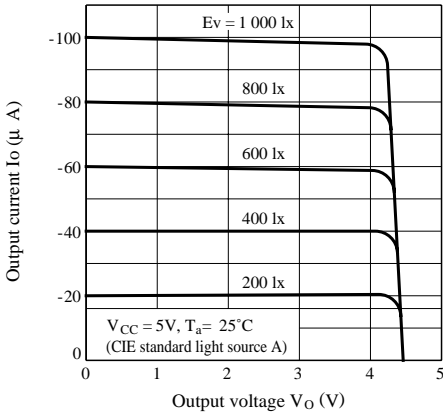

Fig. 7 Output Current vs. Output Voltage



Output Current vs. Output Voltage Test Circuit

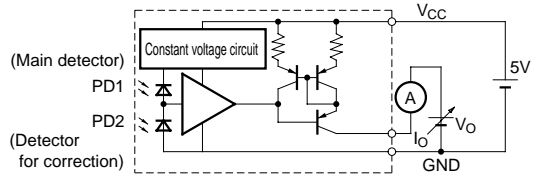

Fig. 8 Supply Current vs. Supply Voltage

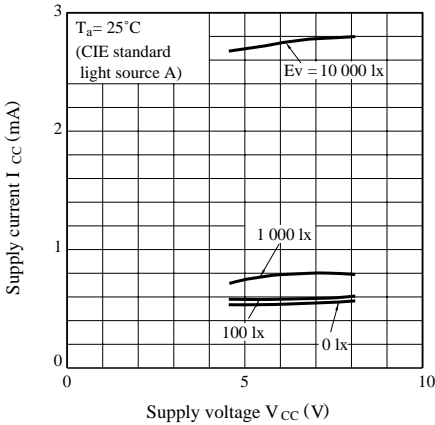

Fig. 9 Supply Current vs. Illuminance

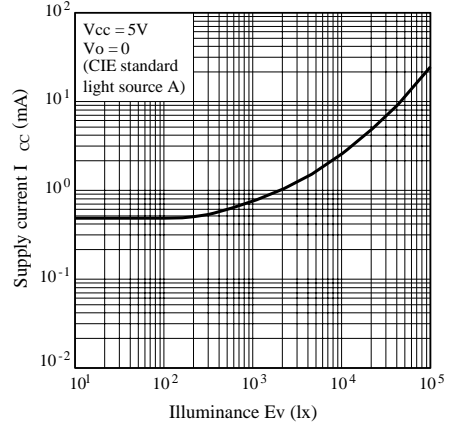
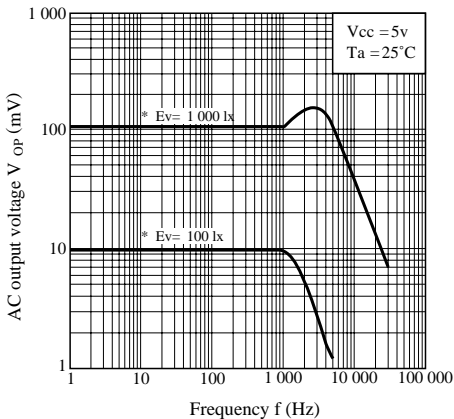
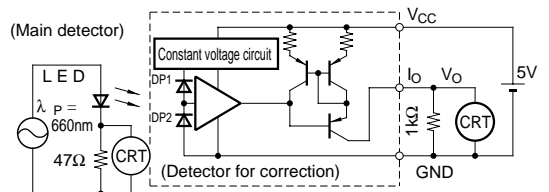

Fig. 10 Frequency Characteristics



Frequency Characteristics Test Circuit



* Incident light quantity E_v : Converted value of DC component of output voltage V_o

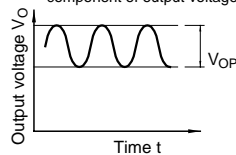

Fig. 11 Radiation Diagram (Right/Left Direction)

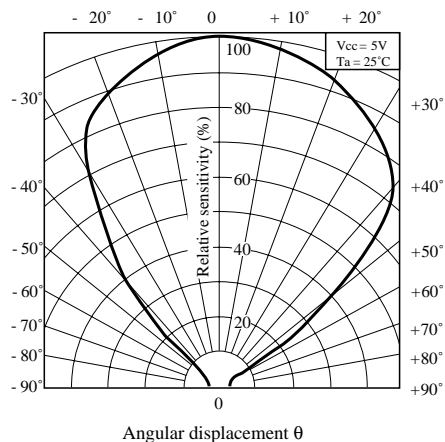
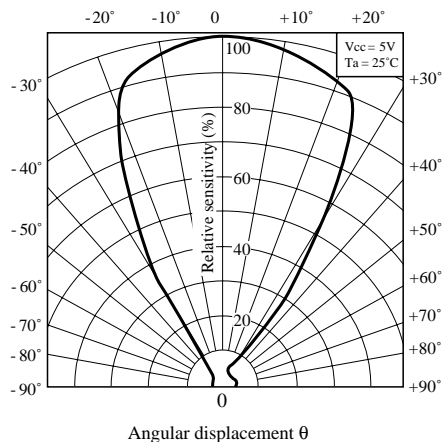
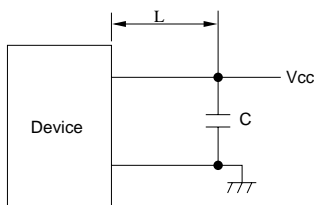

Fig. 12 Radiation Diagram (Top/Bottom Direction)



■ Precautions for Operation

- (1) It is recommended to connect a capacitor between V_{CC} and GND near the device in order to stabilize power supply line



$$L \leq 20 \text{ mm}$$

$$C \geq 0.01 \mu\text{F}$$

2 pieces of photodiodes are built in this device to amplify difference in collector current between them.

Radiation of even light to 2 pieces of photodiodes is recommended.

Radiation of uneven light may cause change of spectral sensitivity or starting failure of the circuit after power is supplied.

(2) Cleaning

- Conduct cleaning as follows.

Solvent dip cleaning : Solvent temperature of 45°C max., dipping time : Within 3 minutes

Ultrasonic cleaning : Elements are affected differently depending on the size of cleaning bath, ultrasonic output, time, size of PWB and mounting method of elements. Conduct trial cleaning on actual operating conditions in advance to make sure that no problem results.

- Use following solvents only.

Solvents : Ethyl alcohol, methyl alcohol and isopropyl alcohol

(3) Soldering

Be sure to perform soldering at values within the maximum ratings. Take care so that not external force is applied to the lead during and immediately after soldering. Do not perform reflow soldering.

- Please refer to the chapter "Precautions for Use". (Page 78 to 93)

NOTICE

- The circuit application examples in this publication are provided to explain representative applications of SHARP devices and are not intended to guarantee any circuit design or license any intellectual property rights. SHARP takes no responsibility for any problems related to any intellectual property right of a third party resulting from the use of SHARP's devices.
- Contact SHARP in order to obtain the latest device specification sheets before using any SHARP device. SHARP reserves the right to make changes in the specifications, characteristics, data, materials, structure, and other contents described herein at any time without notice in order to improve design or reliability. Manufacturing locations are also subject to change without notice.
- Observe the following points when using any devices in this publication. SHARP takes no responsibility for damage caused by improper use of the devices which does not meet the conditions and absolute maximum ratings to be used specified in the relevant specification sheet nor meet the following conditions:
 - (i) The devices in this publication are designed for use in general electronic equipment designs such as:
 - Personal computers
 - Office automation equipment
 - Telecommunication equipment [terminal]
 - Test and measurement equipment
 - Industrial control
 - Audio visual equipment
 - Consumer electronics
 - (ii) Measures such as fail-safe function and redundant design should be taken to ensure reliability and safety when SHARP devices are used for or in connection with equipment that requires higher reliability such as:
 - Transportation control and safety equipment (i.e., aircraft, trains, automobiles, etc.)
 - Traffic signals
 - Gas leakage sensor breakers
 - Alarm equipment
 - Various safety devices, etc.
 - (iii) SHARP devices shall not be used for or in connection with equipment that requires an extremely high level of reliability and safety such as:
 - Space applications
 - Telecommunication equipment [trunk lines]
 - Nuclear power control equipment
 - Medical and other life support equipment (e.g., scuba).
- Contact a SHARP representative in advance when intending to use SHARP devices for any "specific" applications other than those recommended by SHARP or when it is unclear which category mentioned above controls the intended use.
- If the SHARP devices listed in this publication fall within the scope of strategic products described in the Foreign Exchange and Foreign Trade Control Law of Japan, it is necessary to obtain approval to export such SHARP devices.
- This publication is the proprietary product of SHARP and is copyrighted, with all rights reserved. Under the copyright laws, no part of this publication may be reproduced or transmitted in any form or by any means, electronic or mechanical, for any purpose, in whole or in part, without the express written permission of SHARP. Express written permission is also required before any use of this publication may be made by a third party.
- Contact and consult with a SHARP representative if there are any questions about the contents of this publication.