

## DAC 2 click

### 2. Soldering the headers

Before using your click board™, make sure to solder 1x8 male headers to both left and right side of the board. Two 1x8 male headers are included with the board in the package.

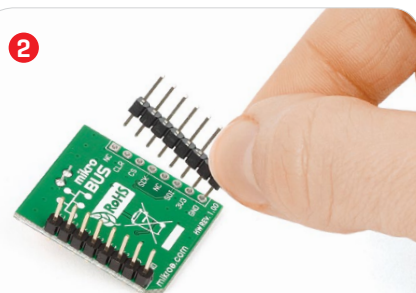
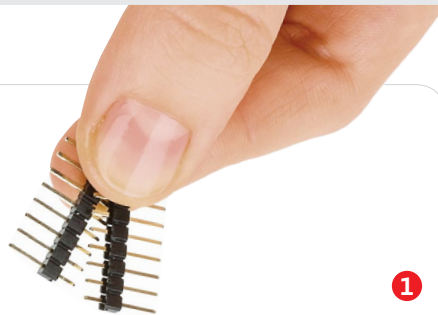

Turn the board upside down so that the bottom side is facing you upwards. Place shorter pins of the header into the appropriate soldering pads.

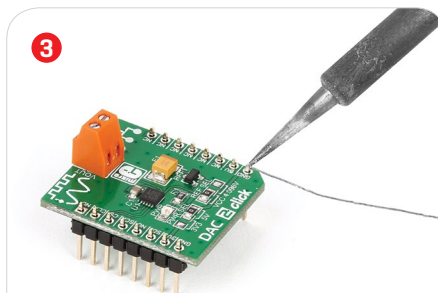

Turn the board upward again. Make sure to align the headers so that they are perpendicular to the board, then solder the pins carefully.

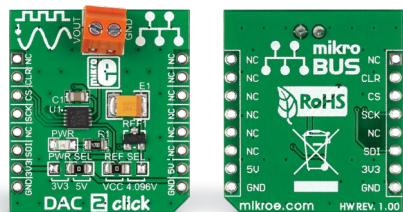

### 1. Introduction

DAC 2 click carries LTC2601CDD, a 16-bit digital-to-analog converter, along with voltage output screw terminals. The chip has high rail-to-rail output drives [ $\pm 15\text{mA}$ , Min] and double-buffered data latches. The click board communicates with the target MCU through the mikroBUS™ SPI interface (MISO, MOSI pins) with clock rates up to 50MHz. Additionally, the CLR pin, in place of default mikroBUS™ RST pin, clears all the registers. The board uses either a 3.3V or 5V power supply.

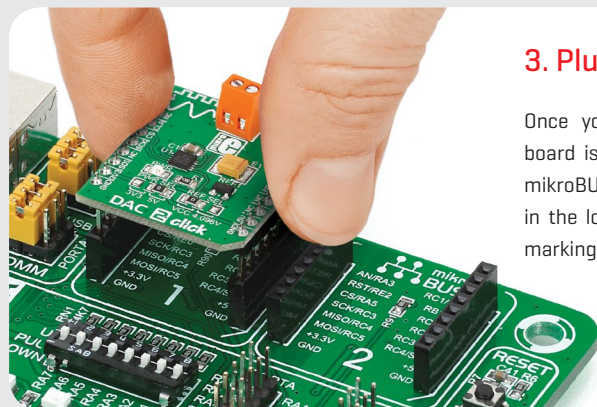

### 3. Plugging the board in

Once you have soldered the headers your board is ready to be placed into the desired mikroBUS™ socket. Make sure to align the cut in the lower-right part of the board with the markings on the silkscreen at the mikroBUS™ socket. If all the pins are aligned correctly, push the board all the way into the socket.

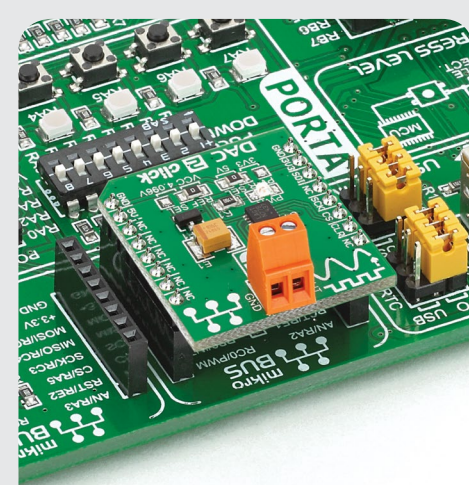

## 5. Schematic

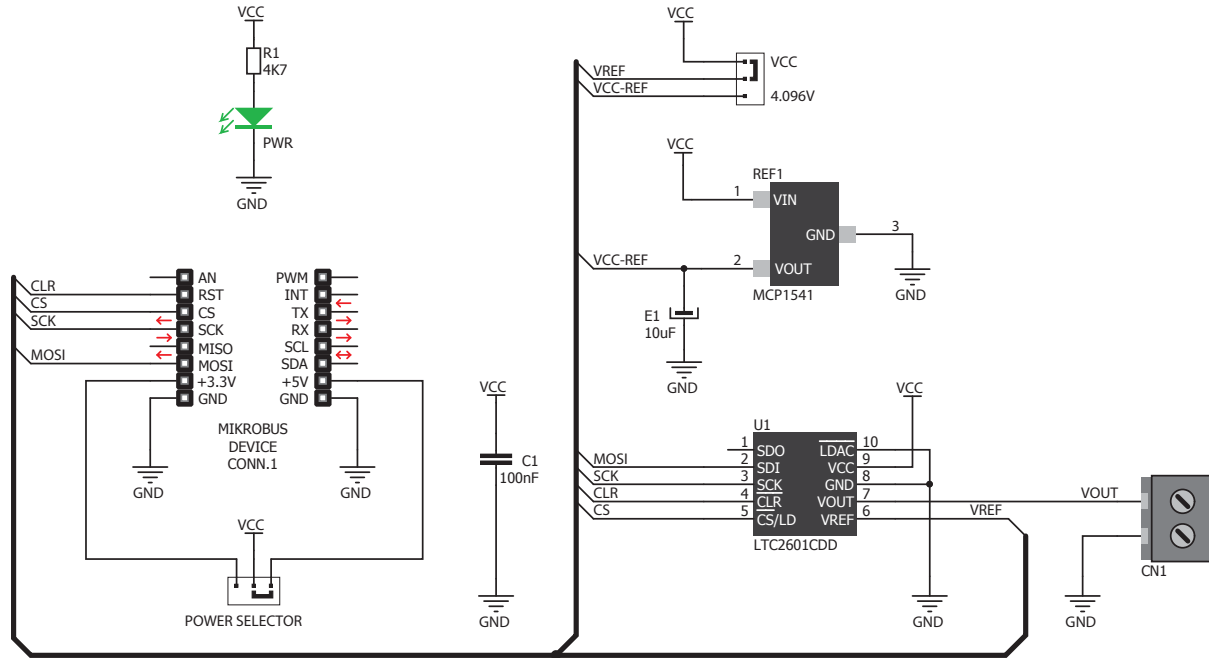

## 6. Dimensions

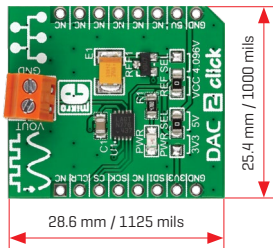

	mm	mils
LENGTH	28.6	1125
WIDTH	25.4	1000
HEIGHT*	10.15	400

\* without headers

## 7. SMD jumpers

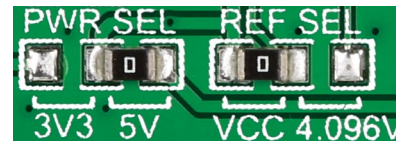

DAC 2 click features two SMD jumpers: PWR SEL for switching between a 3.3V or a 5V power supply, and REF SEL for choosing either VCC or 4.096V as a reference voltage.

## 8. Code examples

Once you have done all the necessary preparations, it's time to get your click board™ up and running. We have provided examples for mikroC™, mikroBasic™ and mikroPascal™ compilers on our **Libstock** website. Just download them and you are ready to start.



## 9. Support

MikroElektronika offers **free tech support** [[www.mikroe.com/support](http://www.mikroe.com/support)] until the end of the product's lifetime, so if something goes wrong, we're ready and willing to help!



## 10. Disclaimer

MikroElektronika assumes no responsibility or liability for any errors or inaccuracies that may appear in the present document. Specification and information contained in the present schematic are subject to change at any time without notice.

Copyright © 2015 MikroElektronika.  
All rights reserved.