

# Micropower Constant Frequency Step-Down DC/DC Controllers in ThinSOT

## FEATURES

- **High Efficiency: Up to 94%**
- **Very Low No-Load Quiescent Current: Only 16 $\mu$ A (LTC3801)**
- **High Output Currents Easily Achieved**
- **Internal Soft-Start**
- **Wide  $V_{IN}$  Range: 2.4V to 9.8V**
- **Low Dropout: 100% Duty Cycle**
- **Constant Frequency 550kHz Operation**
- **Burst Mode<sup>®</sup> Operation for High Efficiency at Light Loads (LTC3801)**
- **Burst Mode Operation Disabled for Lower Output Ripple at Light Loads (LTC3801B)**
- **Output Voltage as Low as 0.8V**
- **$\pm 1.5\%$  Voltage Reference Accuracy**
- **Current Mode Operation for Excellent Line and Load Transient Response**
- **Only 6 $\mu$ A Supply Current in Shutdown (LTC3801)**
- **Low Profile (1mm) SOT-23 Package**

## APPLICATIONS

- 1- or 2-Cell Li-Ion Battery-Powered Applications
- Wireless Devices
- Portable Computers
- Distributed Power Systems

## DESCRIPTION

The LTC<sup>®</sup>3801/LTC3801B are constant frequency current mode step-down DC/DC controllers in a low profile (1mm max) 6-lead SOT-23 (ThinSOT<sup>™</sup>) package. The parts provide excellent AC and DC load and line regulation with  $\pm 1.5\%$  output voltage accuracy. The LTC3801 consumes only 195 $\mu$ A of quiescent current in normal operation, dropping to 16 $\mu$ A under no-load conditions.

The LTC3801/LTC3801B incorporate an undervoltage lock-out feature that shuts down the device when the input voltage falls below 2.2V. The LTC3801 automatically switches into Burst Mode operation at light loads which enhances efficiency at low output current. In the LTC3801B, Burst Mode operation is disabled for lower output ripple at light loads.

To further maximize the life of a battery source, the external P-channel MOSFET is turned on continuously in dropout (100% duty cycle). High switching frequency of 550kHz allows the use of a small inductor.

LT, LTC and LT are registered trademarks of Linear Technology Corporation. Burst Mode is a registered trademark of Linear Technology Corporation. ThinSOT is a trademark of Linear Technology Corporation.

## TYPICAL APPLICATION

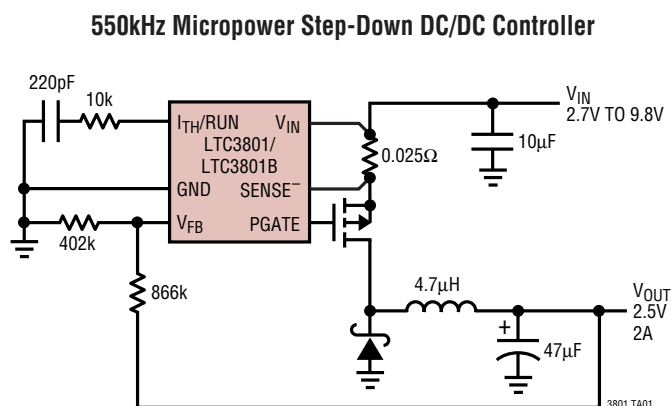

**LTC3801 Efficiency vs Load Current\***

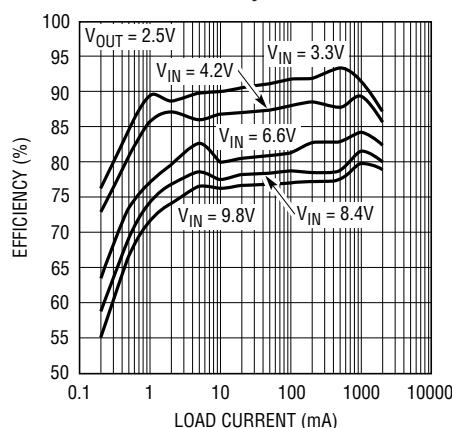

\*SEE NO-LOAD  $I_Q$  vs INPUT VOLTAGE ON THE LAST PAGE OF THIS DATA SHEET  
sn3801 3801fs

## ABSOLUTE MAXIMUM RATINGS

(Note 1)

|                                         |                              |
|-----------------------------------------|------------------------------|
| Input Supply Voltage ( $V_{IN}$ )       | -0.3V to 10V                 |
| SENSE <sup>-</sup> , PGATE Voltages     | -0.3V to ( $V_{IN} + 0.3V$ ) |
| $V_{FB}$ , $I_{TH}/RUN$ Voltages        | -0.3V to 2.4V                |
| PGATE Peak Output Current (<10 $\mu$ s) | 1A                           |
| Operating Temperature Range (Note 2)    | -40°C to 85°C                |
| Junction Temperature (Note 3)           | 150°C                        |
| Storage Temperature Range               | -65°C to 150°C               |
| Lead Temperature (Soldering, 10 sec)    | 300°C                        |

## PACKAGE/ORDER INFORMATION

|  |                           |
|--|---------------------------|
|  | ORDER PART NUMBER         |
|  | LTC3801ES6<br>LTC3801BES6 |
|  | S6 PART MARKING           |
|  | LTACR<br>LTAHN            |

Consult LTC Marketing for parts specified with wider operating temperature ranges.

## ELECTRICAL CHARACTERISTICS

The ● indicates specifications which apply over the full operating temperature range, otherwise specifications are at  $T_A = 25^\circ\text{C}$ .  $V_{IN} = 4.2V$  unless otherwise noted. (Note 2)

| PARAMETER                                          | CONDITIONS                                                   | MIN     | TYP   | MAX   | UNITS             |
|----------------------------------------------------|--------------------------------------------------------------|---------|-------|-------|-------------------|
| Input Voltage Range                                |                                                              | ● 2.4   |       | 9.8   | V                 |
| Input DC Supply Current                            | Typicals at $V_{IN} = 4.2V$ (Note 4)                         |         |       |       |                   |
| Normal Operation                                   | $2.4V \leq V_{IN} \leq 9.8V$ , $V_{ITH}/RUN = 1.3V$          |         | 195   | 300   | $\mu\text{A}$     |
| SLEEP Mode                                         | $2.4V \leq V_{IN} \leq 9.8V$ (LTC3801 Only)                  |         | 16    | 30    | $\mu\text{A}$     |
| Shutdown                                           | $2.4V \leq V_{IN} \leq 9.8V$ , $V_{ITH}/RUN = 0V$ (LTC3801)  |         | 6     | 15    | $\mu\text{A}$     |
| UVLO                                               | $2.4V \leq V_{IN} \leq 9.8V$ , $V_{ITH}/RUN = 0V$ (LTC3801B) |         | 8     | 17    | $\mu\text{A}$     |
| UVLO                                               | $V_{IN} < UVLO$ Threshold                                    |         | 1     | 2     | $\mu\text{A}$     |
| Undervoltage Lockout Threshold                     | $V_{IN}$ Rising                                              | ● 1.8   |       | 2.3   | V                 |
|                                                    | $V_{IN}$ Falling                                             | ● 1.7   |       | 2.2   | V                 |
| Start-Up Current Source                            | $V_{ITH}/RUN = 0V$ (LTC3801)                                 | 0.5     | 1     | 1.5   | $\mu\text{A}$     |
|                                                    | $V_{ITH}/RUN = 0V$ (LTC3801B)                                | 1.0     | 2     | 3.0   | $\mu\text{A}$     |
| Shutdown Threshold (at $I_{TH}/RUN$ )              | $V_{ITH}/RUN$ Rising                                         | ● 0.3   | 0.6   | 0.95  | V                 |
| Regulated Feedback Voltage                         | $0^\circ\text{C} \leq T_A \leq 85^\circ\text{C}$ (Note 5)    | ● 0.788 | 0.800 | 0.812 | V                 |
|                                                    | $-40^\circ\text{C} \leq T_A \leq 85^\circ\text{C}$ (Note 5)  | ● 0.780 | 0.800 | 0.812 | V                 |
| Feedback Voltage Line Regulation                   | $2.4V \leq V_{IN} \leq 9.8V$ (Note 5)                        |         | 0.05  |       | mV/V              |
| Feedback Voltage Load Regulation                   | $I_{TH}/RUN$ Sinking $5\mu\text{A}$ (Note 5)                 |         | 2     |       | mV/ $\mu\text{A}$ |
|                                                    | $I_{TH}/RUN$ Sourcing $5\mu\text{A}$ (Note 5)                |         | 2     |       | mV/ $\mu\text{A}$ |
| $V_{FB}$ Input Current                             | (Note 5)                                                     |         | 2     | 10    | nA                |
| Overshoot Protection Threshold                     | Measured at $V_{FB}$                                         | 0.850   | 0.880 | 0.910 | V                 |
| Overshoot Protection Hysteresis                    |                                                              |         | 40    |       | mV                |
| Oscillator Frequency                               | $V_{FB} = 0.8V$                                              | 500     | 550   | 650   | kHz               |
| Normal Operation                                   | $V_{FB} = 0V$                                                |         | 210   |       | kHz               |
| Output Short Circuit                               |                                                              |         |       |       |                   |
| Gate Drive Rise Time                               | $C_{LOAD} = 3000pF$                                          |         | 40    |       | ns                |
| Gate Drive Fall Time                               | $C_{LOAD} = 3000pF$                                          |         | 40    |       | ns                |
| Peak Current Sense Voltage                         | Duty Cycle < 40% (Note 6)                                    |         |       |       |                   |
|                                                    | LTC3801                                                      | ● 109   | 117   | 125   | mV                |
|                                                    | LTC3801B                                                     | ● 95    | 104   | 113   | mV                |
| Peak Current Sense Voltage in Burst Mode Operation | LTC3801 Only                                                 |         | 26    |       | mV                |
| Default Soft-Start Time                            |                                                              |         | 0.6   |       | ms                |

**Note 1:** Absolute Maximum Ratings are those values beyond which the life of a device may be impaired.

**Note 2:** The LTC3801ES6/LTC3801BES6 are guaranteed to meet specifications from  $0^\circ\text{C}$  to  $70^\circ\text{C}$ . Specifications over the  $-40^\circ\text{C}$  to  $85^\circ\text{C}$  operating temperature range are assured by design, characterization and correlation with statistical process controls.

**Note 3:**  $T_J$  is calculated from the ambient temperature  $T_A$  and power dissipation  $P_D$  according to the following formula:

$$T_J = T_A + (P_D \cdot \theta_{JA})/W$$

**Note 4:** Dynamic supply current is higher due to the gate charge being delivered at the switching frequency.

**Note 5:** The LTC3801/LTC3801B are tested in a feedback loop that serves  $V_{FB}$  to the output of the error amplifier while maintaining  $I_{TH}/RUN$  at the midpoint of the current limit range.

**Note 6:** Peak current sense voltage is reduced dependent on duty cycle as given in Figure 1.

# TYPICAL PERFORMANCE CHARACTERISTICS

**Input DC Supply Current (Normal) vs Input Voltage**

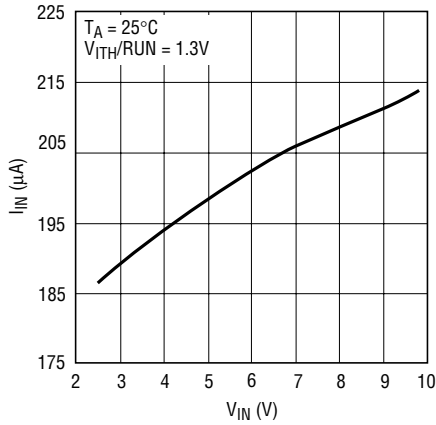

3801 G01

**Input DC Supply Current (SLEEP) vs Input Voltage (LTC3801 Only)**

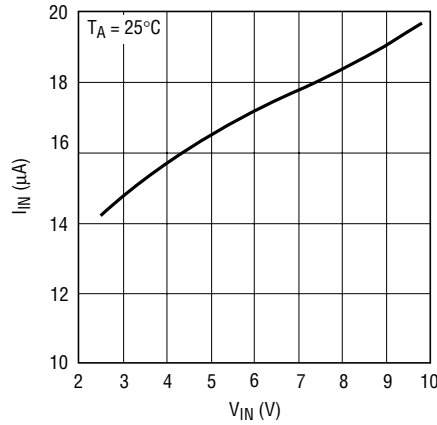

3801 G02

**Input DC Supply Current (Shutdown) vs Input Voltage**

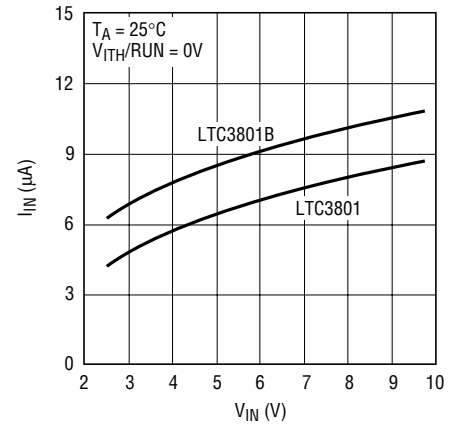

3801 G03

**Undervoltage Lockout Threshold vs Temperature**

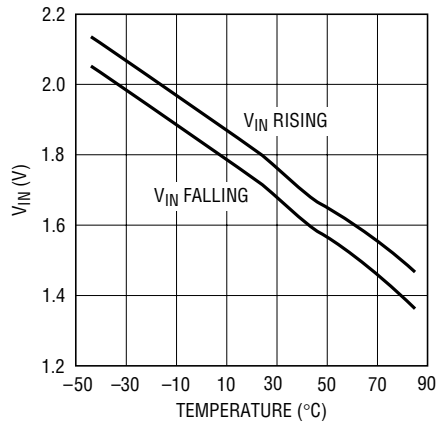

3801 G04

**Shutdown Threshold vs Temperature**

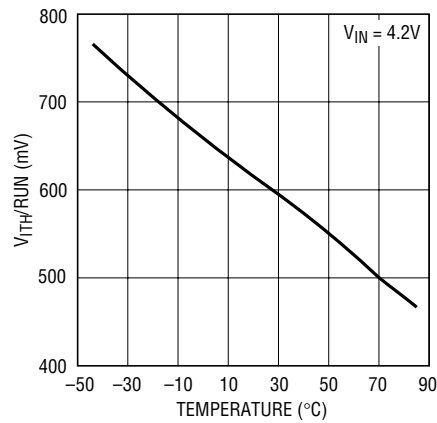

3801 G05

**Regulated Feedback Voltage vs Temperature**

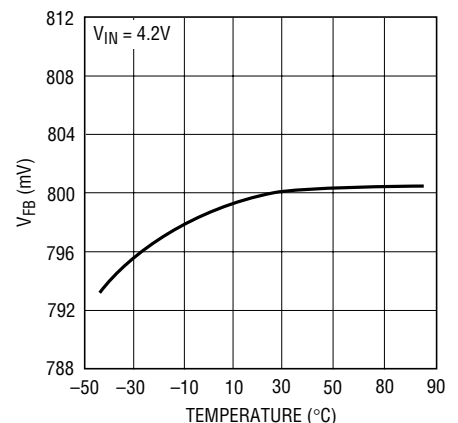

3801 G06

**Regulated Feedback Voltage vs Input Voltage**

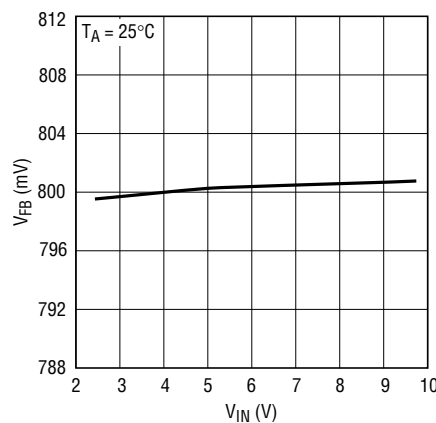

3801 G07

**Oscillator Frequency vs Temperature**

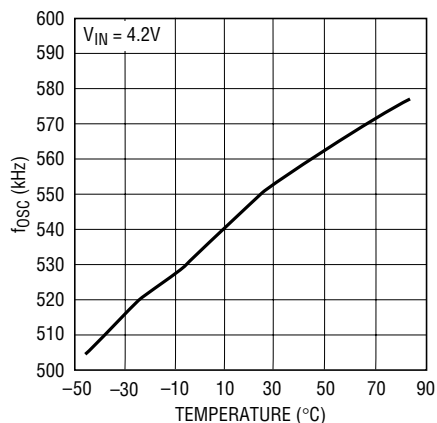

3801 G08

**Oscillator Frequency vs Input Voltage**

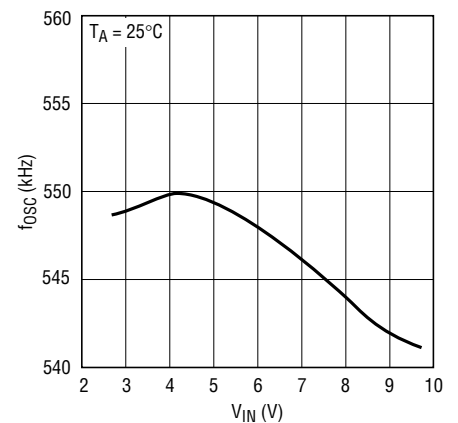

3801 G09

## PIN FUNCTIONS

**$I_{TH}/RUN$  (Pin 1):** This pin performs two functions. It serves as the error amplifier compensation point as well as the run control input. Nominal voltage range for this pin is 0.7V to 1.9V. Forcing this pin below 0.6V causes the device to be shut down. In shutdown, all functions are disabled and the PGATE pin is held high.

**GND (Pin 2):** Ground Pin.

**$V_{FB}$  (Pin 3):** Receives the feedback voltage from an external resistor divider across the output.

**$SENSE^-$  (Pin 4):** Current Sense Pin. An external sense resistor is connected between this pin and  $V_{IN}$  (Pin 5).

**$V_{IN}$  (Pin 5):** Supply Pin. This pin must be closely decoupled to GND (Pin 2).

**PGATE (Pin 6):** Gate Drive for the External P-Channel MOSFET. This pin swings from 0V to  $V_{IN}$ .

## FUNCTIONAL DIAGRAM

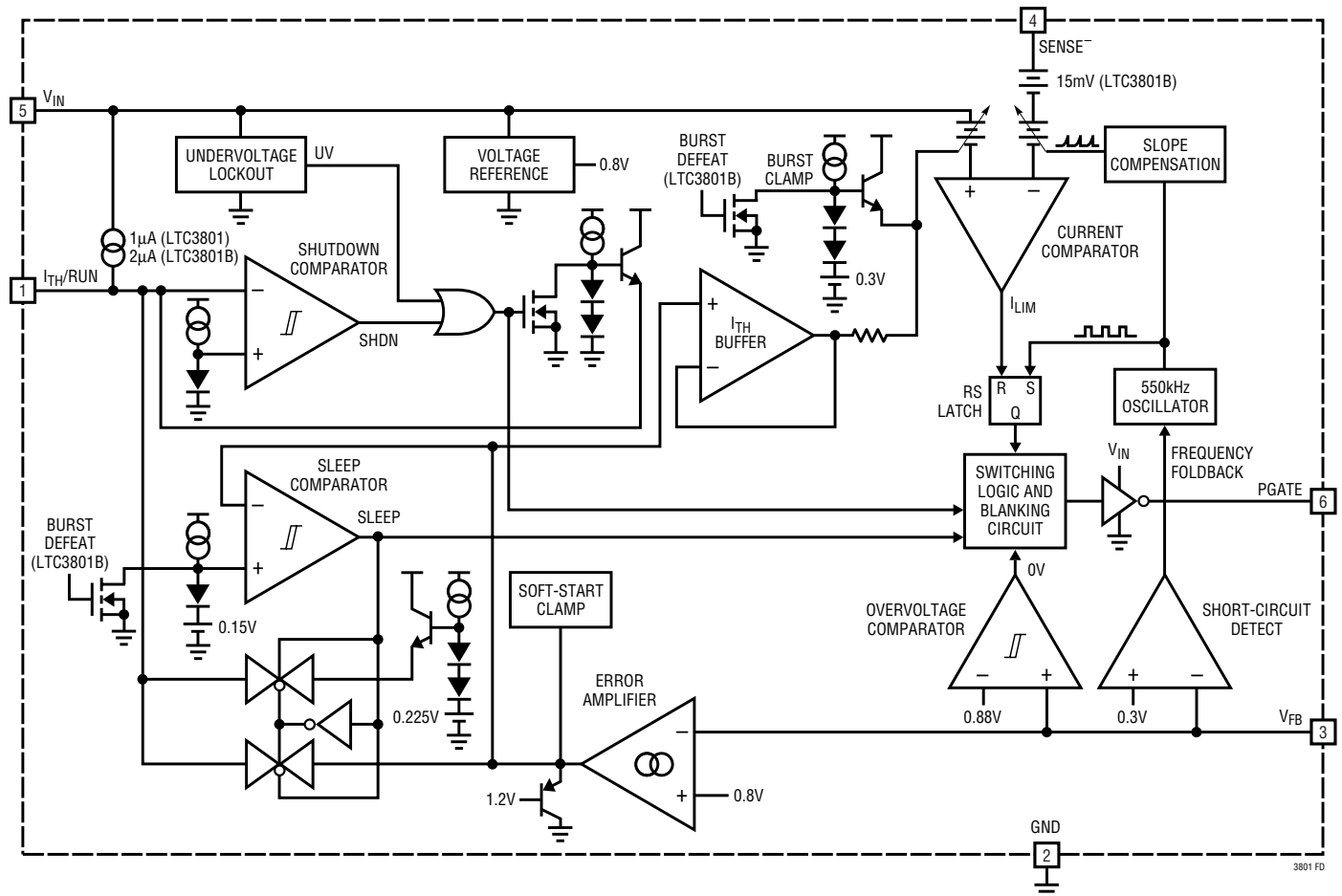

## OPERATION (Refer to the Functional Diagram)

### Main Control Loop (Normal Operation)

The LTC3801/LTC3801B are constant frequency current mode step-down switching regulator controllers. During normal operation, an external P-channel MOSFET is turned on each cycle when the oscillator sets the RS latch and turned off when the current comparator resets the latch. The peak inductor current at which the current comparator trips is controlled by the voltage on the  $I_{TH}/RUN$  pin, which is the output of the error amplifier. The negative input to the error amplifier is the output feedback voltage  $V_{FB}$  which is generated by an external resistor divider connected between  $V_{OUT}$  and ground. When the load current increases, it causes a slight decrease in  $V_{FB}$  relative to the 0.8V reference, which in turn causes the  $I_{TH}/RUN$  voltage to increase until the average inductor current matches the new load current.

The main control loop is shut down by pulling the  $I_{TH}/RUN$  pin to ground. Releasing the  $I_{TH}/RUN$  pin allows an internal  $1\mu A$  current source ( $2\mu A$  on LTC3801B) to charge up the external compensation network. When the  $I_{TH}/RUN$  pin voltage reaches approximately 0.6V, the main control loop is enabled and the  $I_{TH}/RUN$  voltage is pulled up by a clamp to its zero current level of approximately one diode voltage drop (0.7V). As the external compensation network continues to charge up, the corresponding peak inductor current level follows, allowing normal operation. The maximum peak inductor current attainable is set by a clamp on the  $I_{TH}/RUN$  pin at 1.2V above the zero current level (approximately 1.9V).

### Burst Mode Operation (LTC3801 Only)

The LTC3801 incorporates Burst Mode operation at low load currents (<25% of  $I_{MAX}$ ). In this mode, an internal clamp sets the peak current of the inductor at a level corresponding to an  $I_{TH}/RUN$  voltage 0.3V above its zero current level (approximately 1V), even though the actual  $I_{TH}/RUN$  voltage is lower. When the inductor's average current is greater than the load requirement, the voltage at the  $I_{TH}/RUN$  pin will drop. When the  $I_{TH}/RUN$  voltage falls to 0.15V above its zero current level (approximately 0.85V), the sleep comparator will trip, turning off the external MOSFET. In sleep, the input DC supply current to the IC is reduced to  $16\mu A$  from  $195\mu A$  in normal operation. With the switch held off, average inductor current will decay to zero

and the load will eventually cause the error amplifier output to start drifting higher. When the error amplifier output rises to 0.225V above its zero current level (approximately 0.925V), the sleep comparator will untrip and normal operation will resume. The next oscillator cycle will turn the external MOSFET on and the switching cycle will repeat.

### Low Load Current Operation (LTC3801B Only)

Under very light load current conditions, the  $I_{TH}/RUN$  pin voltage will be very close to the zero current level of 0.85V. As the load current decreases further, an internal offset at the current comparator input will ensure that the current comparator remains tripped (even at zero load current) and the regulator will start to skip cycles, as it must, in order to maintain regulation. This behavior allows the regulator to maintain constant frequency down to very light loads, resulting in less low frequency noise generation over a wide load current range.

Figure 1 illustrates this result for the circuit on the front page of this data sheet using both an LTC3801 (in Burst Mode operation) and an LTC3801B (with Burst Mode operation disabled). At an output current of 100mA, the LTC3801 exhibits an output ripple of  $81.6mV_{P-P}$ , whereas the LTC3801B has an output ripple of only  $17.6mV_{P-P}$ . At lower output current levels, the improvement is even greater. This comes at a tradeoff of lower efficiency for the non Burst Mode part at light load currents (see Figure 2). Also notice the constant frequency operation of the LTC3801B, even at 5% of maximum output current.

### Dropout Operation

When the input supply voltage decreases towards the output voltage, the rate of change of inductor current during the on cycle decreases. This reduction means that at some input-output differential, the external P-channel MOSFET will remain on for more than one oscillator cycle (start dropping off-cycles) since the inductor current has not ramped up to the threshold set by the error amplifier. Further reduction in input supply voltage will eventually cause the external P-channel MOSFET to be turned on 100%, i.e., DC. The output voltage will then be determined by the input voltage minus the voltage drop across the sense resistor, the MOSFET and the inductor.

## OPERATION (Refer to the Functional Diagram)

**V<sub>OUT</sub> Ripple for Front Page Circuit Using the LTC3801 (with Burst Mode Operation)**

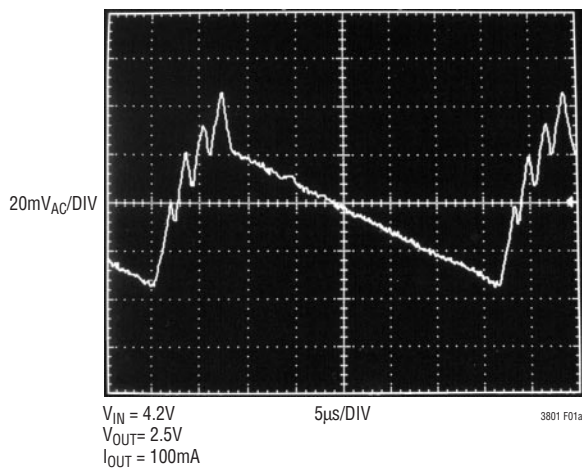

**V<sub>OUT</sub> Ripple for Front Page Circuit Using the LTC3801B (Burst Mode Operation Disabled)**

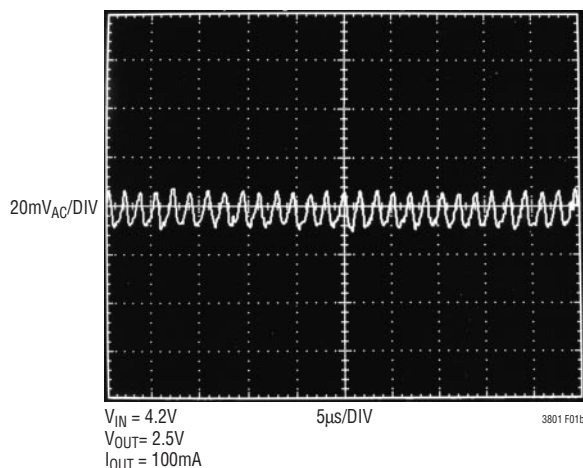

**Figure 1. Output Ripple Waveforms for the Front Page Circuit**

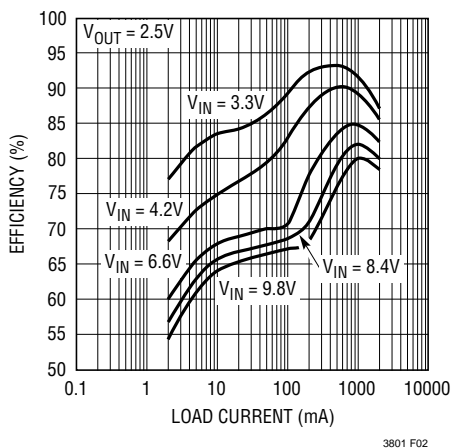

**Figure 2. LTC3801B Efficiency vs Load Current**

### Undervoltage Lockout Protection

To prevent operation of the external P-channel MOSFET with insufficient gate drive, an undervoltage lockout circuit is incorporated into the LTC3801/LTC3801B. When the input supply voltage drops below approximately 1.7V, the P-channel MOSFET and all internal circuitry other than the undervoltage block itself are turned off. Input supply current in undervoltage is approximately 1µA.

### Short-Circuit Protection

If the output is shorted to ground, the frequency of the oscillator is folded back from 550kHz to approximately 210kHz while maintaining the same minimum on time.

This lower frequency allows the inductor current to safely discharge, thereby preventing current runaway. After the short is removed, the oscillator frequency will gradually increase back to 550kHz as  $V_{FB}$  rises through 0.3V on its way back to 0.8V.

### Overvoltage Protection

If  $V_{FB}$  exceeds its regulation point of 0.8V by more than 10% for any reason, such as an output short circuit to a higher voltage, the overvoltage comparator will hold the external P-channel MOSFET off. This comparator has a typical hysteresis of 40mV.

### Slope Compensation and Inductor's Peak Current

The switch on duty cycle in normal operation is given by:

$$\text{Duty Cycle} = \frac{V_{OUT} + V_D}{V_{IN} + V_D}$$

where  $V_D$  is the forward voltage drop of the external diode at the average inductor current. For duty cycles less than 40%, the inductor's peak current is determined by:

$$I_{MAX} = \frac{V_{ITH/RUN} - 0.7V}{10R_{SENSE}}$$

However, for duty cycles greater than 40%, slope compensation begins and effectively reduces the peak

sn3801 3801fs

## OPERATION (Refer to the Functional Diagram)

inductor current. The amount of reduction is given by the curve in Figure 3.

### Soft-Start

An internal default soft-start circuit is employed at power-up and/or when coming out of shutdown. The soft-start circuit works by internally clamping the voltage at the I<sub>TH</sub>/RUN pin to the corresponding zero current level and gradually raising the clamp voltage such that the minimum time required for the programmed switch current to reach its maximum is approximately 0.6ms. After the soft-start circuit has timed out, it is disabled until the part is put in shutdown again or the input supply is cycled.

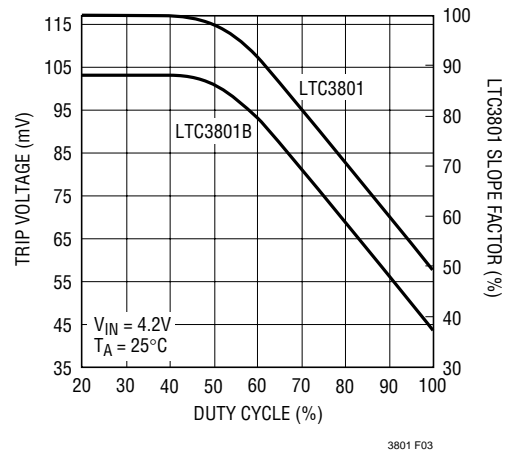

Figure 3. Maximum Current Limit Trip Voltage vs Duty Cycle

## APPLICATIONS INFORMATION

The basic LTC3801/LTC3801B application circuit is shown on the front page of this data sheet. External component selection is driven by the load requirement and begins with the selection of the inductor and R<sub>SENSE</sub>. Next, the power MOSFET and the output diode are selected followed by the input bypass capacitor C<sub>IN</sub> and output bypass capacitor C<sub>OUT</sub>.

### R<sub>SENSE</sub> Selection for Output Current

R<sub>SENSE</sub> is chosen based on the required output current. With the current comparator monitoring the voltage developed across R<sub>SENSE</sub>, the threshold of the comparator determines the inductor's peak current. The output current the LTC3801 can provide is given by:

$$I_{OUT} = \frac{0.117}{R_{SENSE}} - \frac{I_{RIPPLE}}{2}$$

where I<sub>RIPPLE</sub> is the inductor peak-to-peak ripple current (see Inductor Value Calculation section). For the LTC3801B use 104mV in the previous equation and follow through the analysis using that number.

A reasonable starting point for setting ripple current is I<sub>RIPPLE</sub> = (0.4)(I<sub>OUT</sub>). Rearranging the above equation, it becomes:

$$R_{SENSE} = \frac{1}{(10)(I_{OUT})} \text{ for Duty Cycle } < 40\%$$

However, for operation that is above 40% duty cycle, slope compensation effect has to be taken into consideration to select the appropriate value to provide the required amount of current. Using Figure 3, the value of R<sub>SENSE</sub> is:

$$R_{SENSE} = \frac{SF}{(10)(I_{OUT})(100)}$$

where SF is the "Slope Factor."

### Inductor Value Calculation

The operating frequency and inductor selection are inter-related in that higher operating frequencies permit the use of a smaller inductor for the same amount of inductor ripple current. However, this is at the expense of efficiency due to an increase in MOSFET gate charge losses.

The inductance value also has a direct effect on ripple current. The ripple current, I<sub>RIPPLE</sub>, decreases with higher inductance or frequency and increases with higher V<sub>IN</sub> or V<sub>OUT</sub>. The inductor's peak-to-peak ripple current is given by:

$$I_{RIPPLE} = \frac{V_{IN} - V_{OUT}}{f(L)} \left( \frac{V_{OUT} + V_D}{V_{IN} + V_D} \right)$$

where f is the operating frequency. Accepting larger values of I<sub>RIPPLE</sub> allows the use of low inductances, but results in higher output voltage ripple and greater core losses. A reasonable starting point for setting ripple current is

sn3801 3801fs

## APPLICATIONS INFORMATION

$I_{\text{RIPPLE}} = 0.4(I_{\text{OUT(MAX)}})$ . Remember, the maximum  $I_{\text{RIPPLE}}$  occurs at the maximum input voltage.

In Burst Mode operation on the LTC3801, the ripple current is normally set such that the inductor current is continuous during the burst periods. Therefore, the peak-to-peak ripple current must not exceed:

$$I_{\text{RIPPLE}} \leq \frac{0.03}{R_{\text{SENSE}}}$$

This implies a minimum inductance of:

$$L_{\text{MIN}} = \frac{V_{\text{IN}} - V_{\text{OUT}}}{f} \left( \frac{0.03}{R_{\text{SENSE}}} \right) \left( \frac{V_{\text{OUT}} + V_{\text{D}}}{V_{\text{IN}} + V_{\text{D}}} \right)$$

(Use  $V_{\text{IN(MAX)}} = V_{\text{IN}}$ )

A smaller value than  $L_{\text{MIN}}$  could be used in the circuit; however, the inductor current will not be continuous during burst periods.

### Inductor Core Selection

Once the value for  $L$  is known, the type of inductor must be selected. High efficiency converters generally cannot afford the core loss found in low cost powdered iron cores, forcing the use of more expensive ferrite, molypermalloy or Kool M $\mu$ ® cores. Actual core loss is independent of core size for a fixed inductor value, but it is very dependent on inductance selected. As inductance increases, core losses go down. Unfortunately, increased inductance requires more turns of wire and therefore copper losses will increase. Ferrite designs have very low core losses and are preferred at high switching frequencies, so design goals can concentrate on copper loss and preventing saturation. Ferrite core material saturates “hard,” which means that inductance collapses abruptly when the peak design current is exceeded. This results in an abrupt increase in inductor ripple current and consequent output voltage ripple. Do not allow the core to saturate!

Molypermalloy (from Magnetics, Inc.) is a very good, low loss core material for toroids, but it is more expensive than ferrite. A reasonable compromise from the same

manufacturer is Kool M $\mu$ . Toroids are very space efficient, especially when you can use several layers of wire. Because they generally lack a bobbin, mounting is more difficult. However, new designs for surface mount that do not increase the height significantly are available.

### Power MOSFET Selection

An external P-channel power MOSFET must be selected for use with the LTC3801/LTC3801B. The main selection criteria for the power MOSFET are the threshold voltage  $V_{\text{GS(TH)}}$  and the “on” resistance  $R_{\text{DS(ON)}}$ , reverse transfer capacitance  $C_{\text{RSS}}$  and total gate charge.

Since the LTC3801/LTC3801B are designed for operation down to low input voltages, a sublogic level threshold MOSFET ( $R_{\text{DS(ON)}}$  guaranteed at  $V_{\text{GS}} = 2.5\text{V}$ ) is required for applications that work close to this voltage. When these MOSFETs are used, make sure that the input supply to the LTC3801/LTC3801B is less than the absolute maximum  $V_{\text{GS}}$  rating, typically 8V.

The required minimum  $R_{\text{DS(ON)}}$  of the MOSFET is governed by its allowable power dissipation. For applications that may operate the LTC3801/LTC3801B in dropout, i.e., 100% duty cycle, at its worst case the required  $R_{\text{DS(ON)}}$  is given by:

$$R_{\text{DS(ON)DC=100\%}} = \frac{P_{\text{P}}}{(I_{\text{OUT(MAX)}})^2 (1 + \delta p)}$$

where  $P_{\text{P}}$  is the allowable power dissipation and  $\delta p$  is the temperature dependency of  $R_{\text{DS(ON)}}$ .  $(1 + \delta p)$  is generally given for a MOSFET in the form of a normalized  $R_{\text{DS(ON)}}$  vs temperature curve, but  $\delta p = 0.005/^{\circ}\text{C}$  can be used as an approximation for low voltage MOSFETs.

In applications where the maximum duty cycle is less than 100% and the LTC3801/LTC3801B are in continuous mode, the  $R_{\text{DS(ON)}}$  is governed by:

$$R_{\text{DS(ON)}} \cong \frac{P_{\text{P}}}{(\text{DC}) I_{\text{OUT}}^2 (1 + \delta p)}$$

where DC is the maximum operating duty cycle of the LTC3801/LTC3801B.



## APPLICATIONS INFORMATION

### Output Diode Selection

The catch diode carries load current during the off-time. The average diode current is therefore dependent on the P-channel switch duty cycle. At high input voltages the diode conducts most of the time. As  $V_{IN}$  approaches  $V_{OUT}$  the diode conducts only a small fraction of the time. The most stressful condition for the diode is when the output is short-circuited. Under this condition the diode must safely handle  $I_{PEAK}$  at close to 100% duty cycle. Therefore, it is important to adequately specify the diode peak current and average power dissipation so as not to exceed the diode ratings.

Under normal load conditions, the average current conducted by the diode is:

$$I_D = \left( \frac{V_{IN} - V_{OUT}}{V_{IN} + V_D} \right) I_{OUT}$$

The allowable forward voltage drop in the diode is calculated from the maximum short-circuit current as:

$$V_F \approx \frac{P_D}{I_{SC(MAX)}}$$

where  $P_D$  is the allowable power dissipation and will be determined by efficiency and/or thermal requirements.

A fast switching diode must also be used to optimize efficiency. Schottky diodes are a good choice for low forward drop and fast switching times. Remember to keep lead length short and observe proper grounding to avoid ringing and increased dissipation.

An additional consideration in applications where low no-load quiescent current is critical is the reverse leakage current of the diode at the regulated output voltage. A leakage greater than several microamperes can represent a significant percentage of the total input current.

### $C_{IN}$ and $C_{OUT}$ Selection

In continuous mode, the source current of the P-channel MOSFET is a square wave of duty cycle  $(V_{OUT} + V_D)/(V_{IN} + V_D)$ . To prevent large voltage transients, a low ESR

input capacitor sized for the maximum RMS current must be used. The maximum RMS capacitor current is given by:

$$C_{IN} \text{ Required } I_{RMS} \approx I_{MAX} \frac{[V_{OUT}(V_{IN} - V_{OUT})]^{1/2}}{V_{IN}}$$

This formula has a maximum value at  $V_{IN} = 2V_{OUT}$ , where  $I_{RMS} = I_{OUT}/2$ . This simple worst-case condition is commonly used for design because even significant deviations do not offer much relief. Note that capacitor manufacturer's ripple current ratings are often based on 2000 hours of life. This makes it advisable to further derate the capacitor, or to choose a capacitor rated at a higher temperature than required. Several capacitors may be paralleled to meet the size or height requirements in the design. Due to the high operating frequency of the LTC3801/LTC3801B, ceramic capacitors can also be used for  $C_{IN}$ . Always consult the manufacturer if there is any question.

The selection of  $C_{OUT}$  is driven by the required effective series resistance (ESR). Typically, once the ESR requirement is satisfied, the capacitance is adequate for filtering. The output ripple ( $\Delta V_{OUT}$ ) is approximated by:

$$\Delta V_{OUT} \approx I_{RIPPLE} \left( ESR + \frac{1}{8fC_{OUT}} \right)$$

where  $f$  is the operating frequency,  $C_{OUT}$  is the output capacitance and  $I_{RIPPLE}$  is the ripple current in the inductor. The output ripple is highest at maximum input voltage since  $\Delta I_L$  increases with input voltage.

Manufacturers such as Nichicon, United Chemicon and Sanyo should be considered for high performance through-hole capacitors. The OS-CON semiconductor dielectric capacitor available from Sanyo has the lowest ESR (size) product of any aluminum electrolytic at a somewhat higher price. Once the ESR requirement for  $C_{OUT}$  has been met, the RMS current rating generally far exceeds the  $I_{RIPPLE(P-P)}$  requirement.

In surface mount applications, multiple capacitors may have to be paralleled to meet the ESR or RMS current handling requirements of the application. Aluminum electrolytic and dry tantalum capacitors are both available in

## APPLICATIONS INFORMATION

surface mount configurations. In the case of tantalum, it is critical that the capacitors are surge tested for use in switching power supplies. An excellent choice is the AVX TPS, AVX TPSV and KEMET T510 series of surface mount tantalum, available in case heights ranging from 2mm to 4mm. Other capacitor types include Sanyo OS-CON, Nichicon PL series and Panasonic SP.

### Setting Output Voltage

The LTC3801/LTC3801B develop a 0.8V reference voltage between the feedback (Pin 3) terminal and ground (see Figure 4). By selecting resistor R1, a constant current is caused to flow through R1 and R2 to set the overall output voltage. The regulated output voltage is determined by:

$$V_{OUT} = 0.8 \left( 1 + \frac{R2}{R1} \right)$$

For most applications, an 80k resistor is suggested for R1. In applications where low no-load quiescent current is critical, R1 should be made >400k to limit the feedback divider current to approximately 10% of the chip quiescent current. If R2 then results in a very high impedance, it may be beneficial to bypass R2 with a 5pF to 10pF capacitor. To prevent stray pickup, locate resistors R1 and R2 close to LTC3801/LTC3801B.

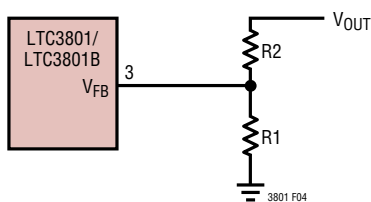

Figure 4. Setting Output Voltage

### Efficiency Considerations

The efficiency of a switching regulator is equal to the output power divided by the input power times 100%. It is often useful to analyze individual losses to determine what is limiting the efficiency and which change would produce the most improvement. Efficiency can be expressed as:

$$\text{Efficiency} = 100\% - (\eta_1 + \eta_2 + \eta_3 + \dots)$$

where  $\eta_1$ ,  $\eta_2$ , etc. are the individual losses as a percentage of input power.

Although all dissipative elements in the circuit produce losses, four main sources usually account for most of the losses in LTC3801/LTC3801B circuits: 1) LTC3801/LTC3801B DC bias current, 2) MOSFET gate charge current, 3)  $I^2R$  losses and 4) voltage drop of the output diode.

1. The  $V_{IN}$  current is the DC supply current, given in the electrical characteristics, that excludes MOSFET driver and control currents.  $V_{IN}$  current results in a small loss which increases with  $V_{IN}$ .
2. MOSFET gate charge current results from switching the gate capacitance of the power MOSFET. Each time a MOSFET gate is switched from low to high to low again, a packet of charge  $dQ$  moves from  $V_{IN}$  to ground. The resulting  $dQ/dt$  is a current out of  $V_{IN}$  which is typically much larger than the DC supply current. In continuous mode,  $I_{GATECHG} = (f)(dQ)$ .
3.  $I^2R$  losses are predicted from the DC resistances of the MOSFET, inductor and current shunt. In continuous mode the average output current flows through L but is "chopped" between the P-channel MOSFET (in series with  $R_{SENSE}$ ) and the output diode. The MOSFET  $R_{DS(ON)}$  plus  $R_{SENSE}$  multiplied by duty cycle can be summed with the resistances of L and  $R_{SENSE}$  to obtain  $I^2R$  losses.
4. The output diode is a major source of power loss at high currents and gets worse at high input voltages. The diode loss is calculated by multiplying the forward voltage times the diode duty cycle multiplied by the load current. For example, assuming a duty cycle of 50% with a Schottky diode forward voltage drop of 0.4V, the loss increases from 0.5% to 8% as the load current increases from 0.5A to 2A.
5. Transition losses apply to the external MOSFET and increase at higher operating frequencies and input voltages. Transition losses can be estimated from:

$$\text{Transition Loss} = 2(V_{IN})^2 I_{O(MAX)} C_{RSS}(f)$$

Other losses including  $C_{IN}$  and  $C_{OUT}$  ESR dissipative losses, and inductor core losses, generally account for less than 2% total additional loss.

## APPLICATIONS INFORMATION

### Foldback Current Limiting

As described in the Output Diode Selection, the worst-case dissipation occurs with a short-circuited output when the diode conducts the current limit value almost continuously. To prevent excessive heating in the diode, foldback current limiting can be added to reduce the current in proportion to the severity of the fault.

Foldback current limiting is implemented by adding diodes  $D_{FB1}$  and  $D_{FB2}$  between the output and the  $I_{TH}/RUN$  pin as shown in Figure 5. In a hard short ( $V_{OUT} = 0V$ ), the current will be reduced to approximately 50% of the maximum output current.

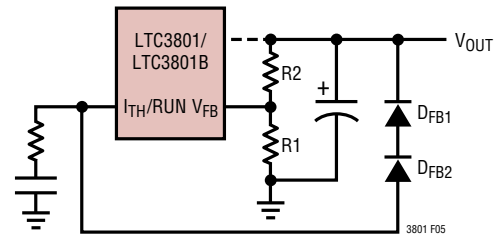
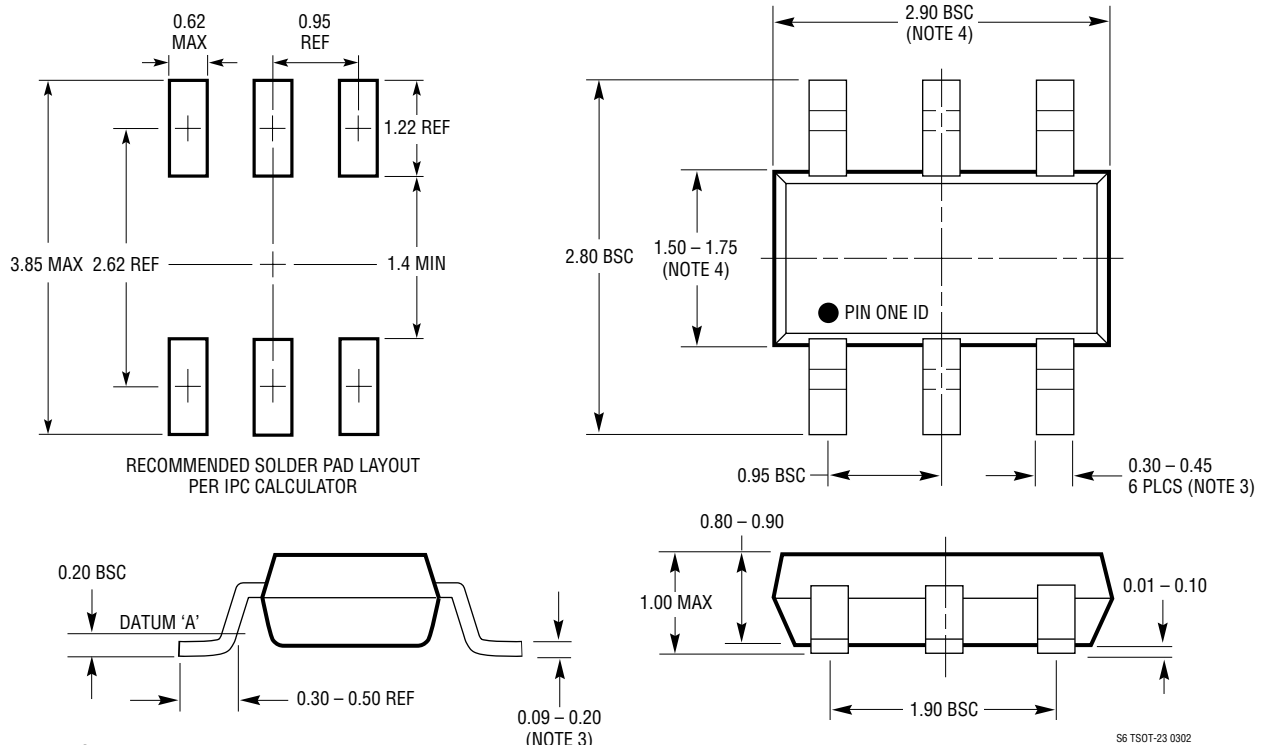

Figure 5. Foldback Current Limiting

## PACKAGE DESCRIPTION

**S6 Package**  
**6-Lead Plastic TSOT-23**  
 (Reference LTC DWG # 05-08-1636)



**NOTE:**

1. DIMENSIONS ARE IN MILLIMETERS
2. DRAWING NOT TO SCALE
3. DIMENSIONS ARE INCLUSIVE OF PLATING
4. DIMENSIONS ARE EXCLUSIVE OF MOLD FLASH AND METAL BURR
5. MOLD FLASH SHALL NOT EXCEED 0.254mm
6. JEDEC PACKAGE REFERENCE IS MO-193

# LTC3801/LTC3801B

## TYPICAL APPLICATION

### 550kHz Micropower Step-Down DC/DC Controller

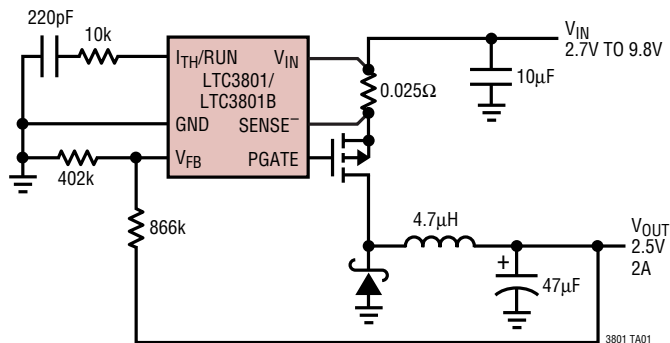

### LTC3801 No-Load $I_Q$ vs Input Voltage\*

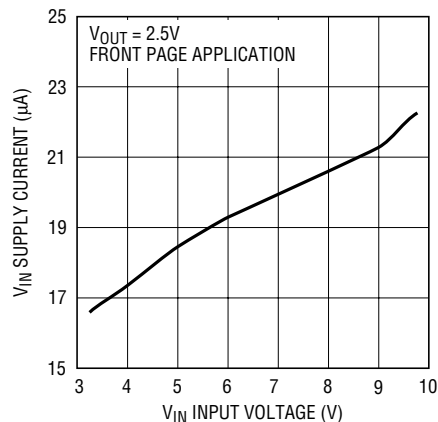

\*SEE THE FRONT PAGE OF THIS DATA SHEET FOR THE EFFICIENCY vs LOAD CURRENT CURVE

## RELATED PARTS

| PART NUMBER          | DESCRIPTION                                                      | COMMENTS                                                                                                      |
|----------------------|------------------------------------------------------------------|---------------------------------------------------------------------------------------------------------------|
| LTC1147 Series       | High Efficiency Step-Down Switching Regulator Controllers        | 100% Duty Cycle, $3.5V \leq V_{IN} \leq 16V$                                                                  |
| LTC1622              | Low Input Voltage Current Mode Step-Down DC/DC Controller        | $V_{IN}$ 2V to 10V, $I_{OUT}$ Up to 4.5A, Synchronizable to 750kHz Optional Burst Mode Operation, 8-Lead MSOP |
| LTC1624              | High Efficiency SO-8 N-Channel Switching Regulator Controller    | N-Channel Drive, $3.5V \leq V_{IN} \leq 36V$                                                                  |
| LTC1625              | No $R_{SENSE}^{\text{TM}}$ Synchronous Step-Down Regulator       | 97% Efficiency, No Sense Resistor                                                                             |
| LTC1702A             | 550kHz, 2 Phase, Dual Synchronous Controller                     | Two Channels; Minimum $C_{IN}$ and $C_{OUT}$ , $I_{OUT}$ up to 15A                                            |
| LTC1733              | Li-Ion Linear Battery Charger                                    | Standalone Charger with Charge Termination, Integrated MOSFET, Thermal Regulator Prevents Overheating         |
| LT <sup>®</sup> 1765 | 25V, 2.75A ( $I_{OUT}$ ), 1.25MHz Step-Down Converter            | $3V \leq V_{IN} \leq 25V$ , $V_{OUT} \geq 1.2V$ , SO-8 and TSSOP16 Packages                                   |
| LTC1771              | Ultra-Low Supply Current Step-Down DC/DC Controller              | 10 $\mu A$ Supply Current, 93% Efficiency, $1.23V \leq V_{OUT} \leq 18V$ ; $2.8V \leq V_{IN} \leq 20V$        |
| LTC1772/LTC1772B     | 550kHz ThinSOT Step-Down DC/DC Controllers                       | $2.5V \leq V_{IN} \leq 9.8V$ , $V_{OUT} \geq 0.8V$ , $I_{OUT} \leq 6A$                                        |
| LTC1778/LTC1778-1    | No $R_{SENSE}$ Current Mode Synchronous Step-Down Controllers    | $4V \leq V_{IN} \leq 36V$ , $0.8V \leq V_{OUT} \leq (0.9)(V_{IN})$ , $I_{OUT}$ Up to 20A                      |
| LTC1779              | 250mA Monolithic Step-Down Converter in ThinSOT                  | $2.5V \leq V_{IN} \leq 9.8V$ , 550kHz, $V_{OUT} \geq 0.8V$                                                    |
| LTC1872/LTC1872B     | 550kHz ThinSOT Step-Up DC/DC Controllers                         | $2.5V \leq V_{IN} \leq 9.8V$ ; 90% Efficiency                                                                 |
| LTC3411/LTC3412      | 1.25/2.5A Monolithic Synchronous Step-Down Converter             | 95% Efficiency, $2.5V \leq V_{IN} \leq 5.5V$ , $V_{OUT} \geq 0.8V$ , TSSOP16 Exposed Pad Package              |
| LTC3440              | 600mA ( $I_{OUT}$ ), 2MHz Synchronous Buck-Boost DC/DC Converter | $2.5V \leq V_{IN} \leq 5.5V$ , Single Inductor                                                                |

No  $R_{SENSE}$  is a trademark of Linear Technology Corporation.

sn3801 3801fs