

SMOV25S[®] Varistor Series

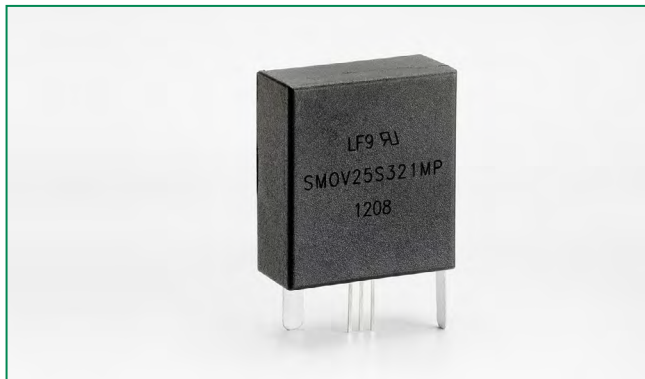

Agency Approvals

Agency	Agency Approval	Agency File Number
	UL1449	E320116

Additional Information



Datasheet



Resources



Samples

Description

The Littelfuse SMOV[®]25S thermally protected varistor is a self-protected device. It consists of a 25mm square varistor with an integral thermal disconnect designed to open in the event of overheating due to abnormal overvoltage as outlined in UL1449. The SMOV[®] helps facilitate SPD module compliance to UL1449 and offers quick thermal response due to the close proximity of the integrated thermal element to the MOV body. This configuration also offers lower inductance than most discreet solutions resulting in improved clamping performance to fast over voltage transients.

The device has a separate micro-switch, which can be used to indicate that the MOV has been disconnected from the circuit. This separate switch makes the monitoring circuitry completely isolated from the main power which ensures indicator circuit safety and simplifies the customers circuit design.

Features

- Maximum single surge capability 20 kA, 8/20 waveshape.
- Nominal Discharge Current Value: 10kA.
- Intermediate current rating: 50A/150A.
- -45°C to +75°C operating temperature.
- Recognized to UL 1449.
- Lead-Free and RoHS compliant.
- Integrated micro-switch for indication circuitry/design.

Applications

- SPD applications
- AC/DC distribution
- IT/Data center
- Power supplier
- Telecommunication

Absolute Maximum Ratings

• For ratings of individual members of a series, see Device Ratings and Specifications chart.

	SMOV25S Varistor Series	Units
Continuous:		
Steady State Applied Voltage:		
DC Voltage Range (VM(DC))	150 to 970	V
AC Voltage Range (V _{M(AC)RMS})	115 to 750	V
Transient:		
Non-Repetitive Surge Current, 8/20µs Waveform (I _{TM})	20,000	A
Non-Repetitive Energy Capability, 2ms Waveform (W _{TM})	170 to 670	J
Operating Ambient Temperature Range (T _A)	-45 to +75	°C
Storage Temperature Range (T _{STG})	-45 to +85	°C
Hi-Pot Encapsulation (Isolation Voltage Capability)	2500	V
Isolation Voltage Capability (when the thermal disconnect opens)	1500	V
Housing Insulation Resistance	>1,000	MΩ

CAUTION: Stresses above those listed in "Absolute Maximum Ratings" may cause permanent damage to the device. This is a stress only rating and operation of the device at these or any other conditions above those indicated in the operational sections of this specification is not implied.

Device Ratings & Specifications

Part Number	Maximum Rating (75°C)					Specifications (25 °C)				
	Continuous		Transient			Varistor Voltage at 1mA Test Current		Maximum Clamping Voltage 8/20µs		Typical Capacitance f = 1MHz
	AC Volts	DC Volts	Energy 2ms	Peak Surge Current 8/20µs	Nominal Discharge Current (In)					
	$V_{M(AC)}$	$V_{M(DC)}$	W_{TM}	I_{TM} 1 x Pulse	I_n	$V_{N(DC)}$ Min	$V_{N(DC)}$ Max	V_c	I_{PK}	C
	(V)	(V)	(J)	(A)	(A)		(V)	(V)	(A)	(pF)
SMOV25S111MP	115	150	170	20000	10000	162	198	295	100	3200
SMOV25S111NP										
SMOV25S131MP	130	170	190	20000	10000	184.5	225.5	335	100	2800
SMOV25S131NP										
SMOV25S151MP	150	200	220	20000	10000	216	264	390	100	2300
SMOV25S151NP										
SMOV25S181MP	175	225	250	20000	10000	243	297	450	100	1900
SMOV25S181NP										
SMOV25S251MP	250	320	330	20000	10000	351	429	640	100	1400
SMOV25S251NP										
SMOV25S271MP	275	350	350	20000	10000	387	473	700	100	1250
SMOV25S271NP										
SMOV25S301MP	300	385	370	20000	10000	423	517	765	100	1150
SMOV25S301NP										
SMOV25S321MP	320	420	390	20000	10000	459	561	825	100	1080
SMOV25S321NP										
SMOV25S421MP	420	560	460	20000	10000	612	748	1100	100	820
SMOV25S421NP										
SMOV25S461MP	460	615	490	20000	10000	675	825	1220	100	750
SMOV25S461NP										
SMOV25S511MP	510	670	520	20000	10000	738	902	1335	100	680
SMOV25S511NP										
SMOV25S551MP	550	745	550	20000	10000	819	1001	1475	100	630
SMOV25S551NP										
SMOV25S621MP	620	800	600	20000	10000	900	1100	1625	100	550
SMOV25S621NP										
SMOV25S751MP	750	970	670	20000	10000	1080	1320	1950	100	460
SMOV25S751NP										

Average power dissipation of transients should not exceed 1.5 watts

Same ratings and specifications apply to Non Isolated Monitored Switch alternative design. Replace "M" with "N" in the part number. e.g.: SMOV25S111NP.

Refer to Part Number System at the end of this document.

Thermal Characteristics

Typical time to open circuit under UL 1449 Limited Current Abnormal Overvoltage Test:

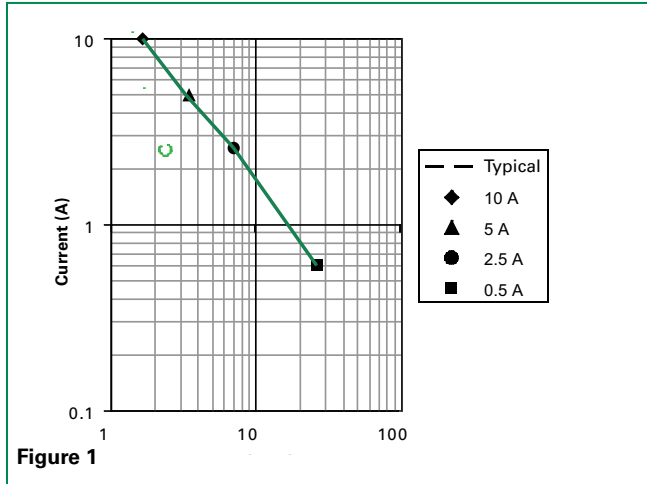

Peak Current & Energy Derating Curve

For applications exceeding 75°C ambient temperature, the peak surge current and energy ratings must be reduced as shown below.

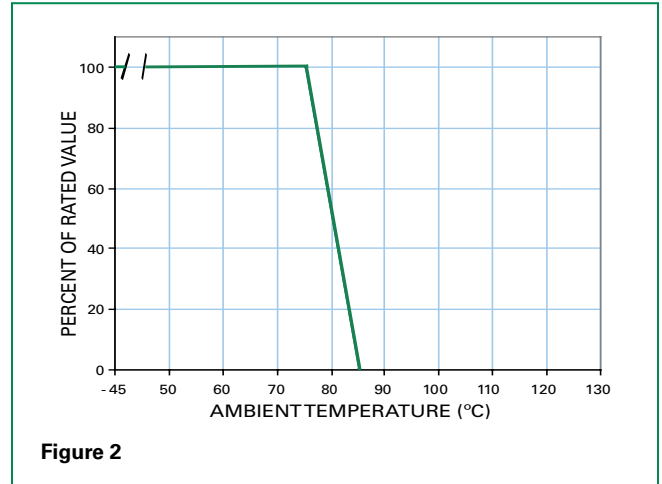

Transient V-I Characteristic Curves

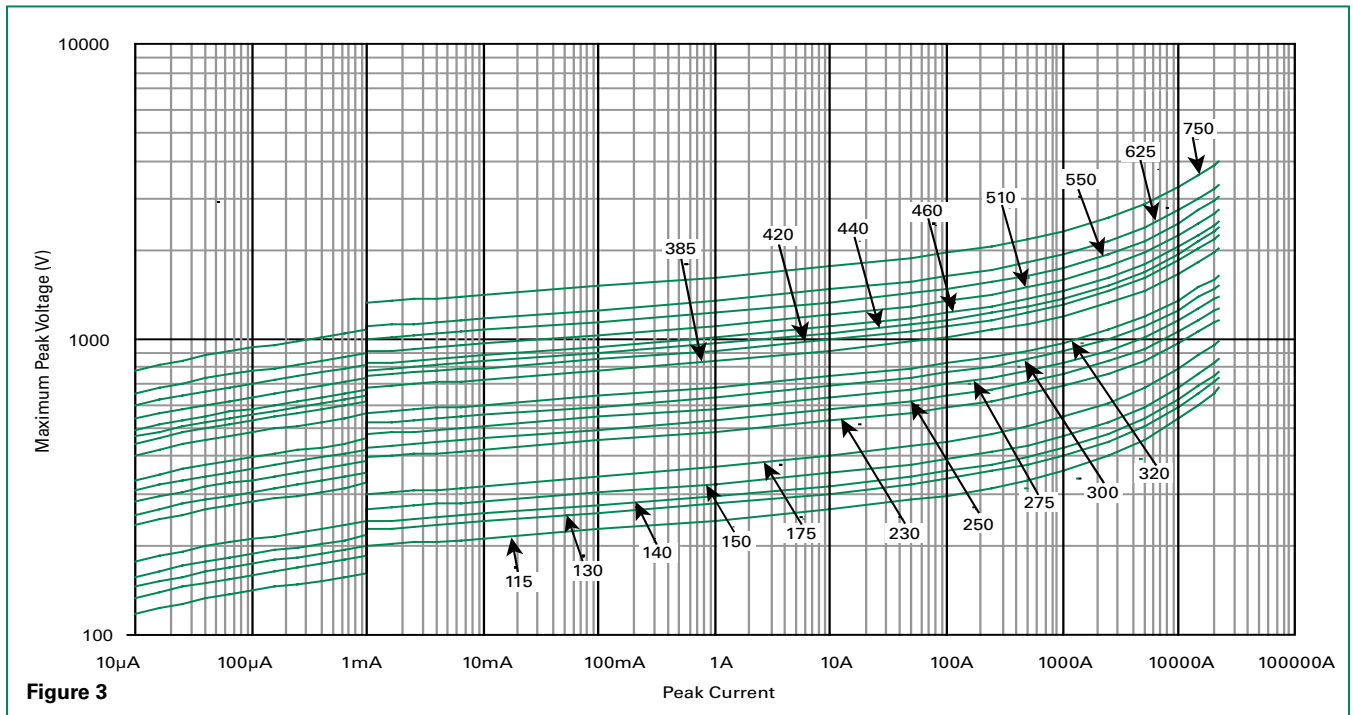

Pulse Rating Curve

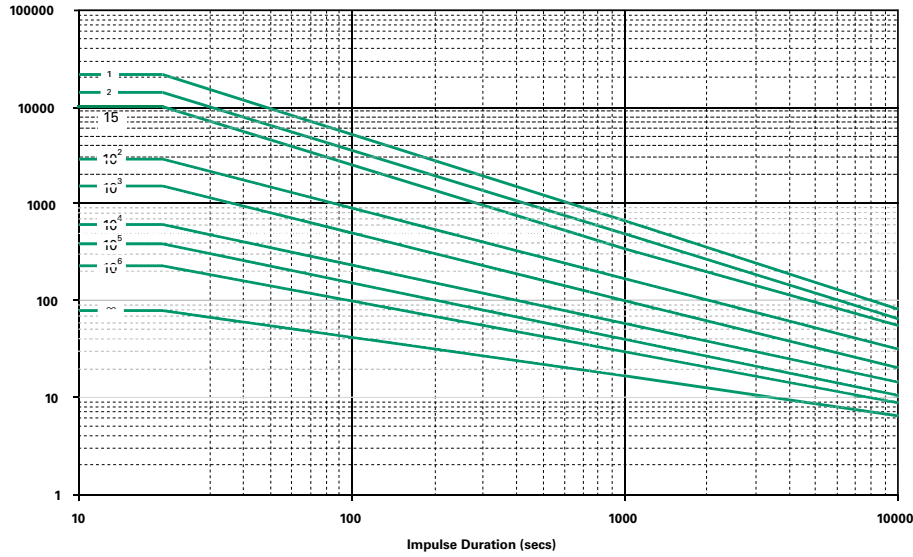

Figure 4

Wave Solder Profile

Because the SMOV®25S Varistors contain a thermal protection device, care must be taken when soldering the devices into place. Two soldering methods are possible. Firstly, hand soldering: It is

recommended to heat-sink the leads of the device. Secondly, wave-soldering: It is critically important that all preheat stage and the solder bath temperatures are rigidly controlled.

Non Lead-free Profile

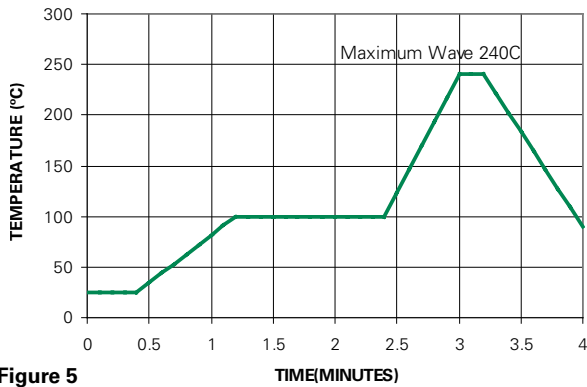

Figure 5

Lead-free Profile

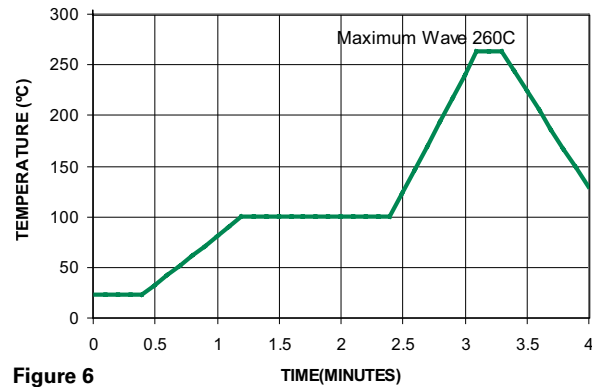

Figure 6

Physical Specifications

Lead Material	Tin-plated
Soldering Characteristics	Solderability per MIL-STD-202, Method 208
Insulating Material	Cured, flame retardant epoxy polymer meets UL94V-0 requirements
Device Labeling	Marked with LF, voltage, UL logos, and date code

Environmental Specifications

Operating/Storage Temp.	-45°C to +75°C
Passive Aging	+75°C, 1000 hours -/+10% typical voltage change
Humidity Aging	+75°C, 85%R.H., 1000 hours -/+10% typical voltage change
Thermal Shock	+75°C to -40°C 5 times -/+10% typical voltage change
Solvent Resistance	MIL-STD-202, Method 215
Moisture Sensitivity	Level 1, J-STD-020

Product Dimensions

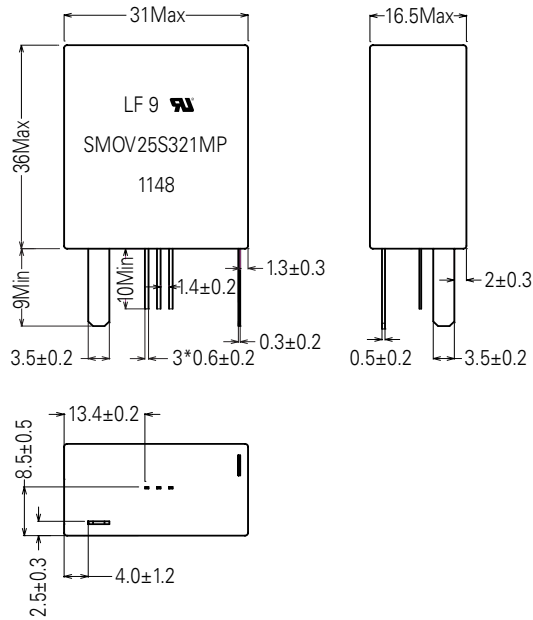

Lead Configuration

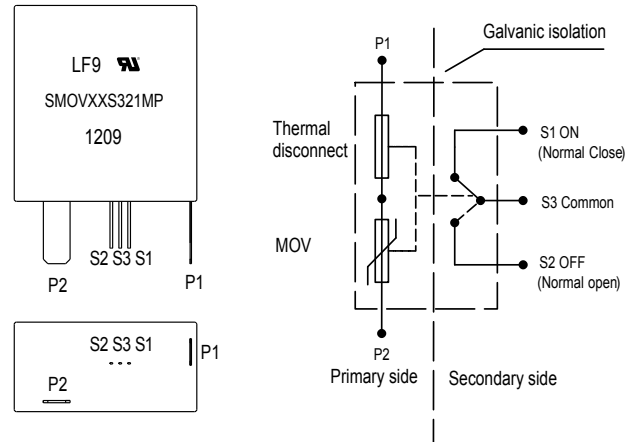

Application Example

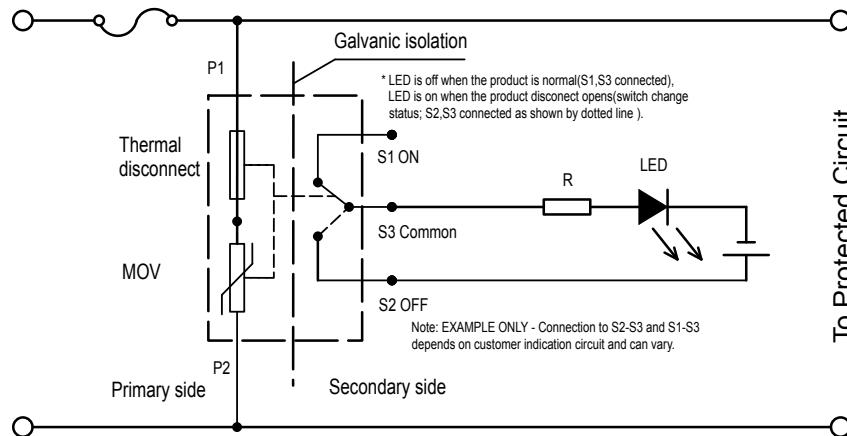

Switch Specification

SMOV Switch	Voltage DC	Current (Amps)	Contact Resistance Max.	Insulation Resistance Min.	Dialectric Strength 0.5mA/Minute
Switch	12V	0.1A	70mΩ	100MΩ	500VAC

Part Numbering System

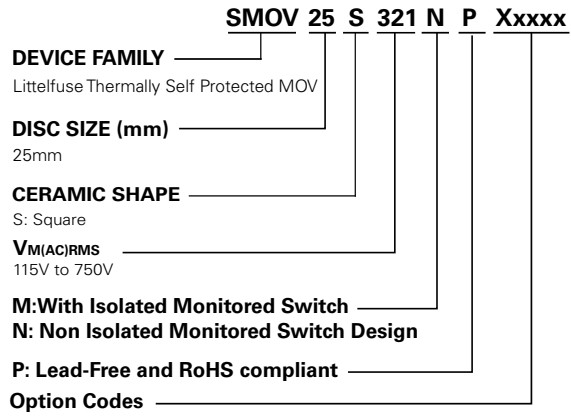

Part Marking System

