

GaAs pHEMT MMIC 1 WATT POWER AMPLIFIER, 40 - 43.5 GHz

Typical Applications

The HMC5929LS6 is ideal for:

- Point-to-Point Radios
- Point-to-Multi-Point Radios
- VSAT & SATCOM
- Military & Space

Features

- Saturated Output Power: +30 dBm @ 15% PAE
- Output IP3: +36 dBm
- High Gain: 19 dB
- DC Supply: +6V @ 900 mA
- No External Matching Required
- 16 Lead Ceramic 6x6 mm SMT Package: 36 mm²

Functional Diagram

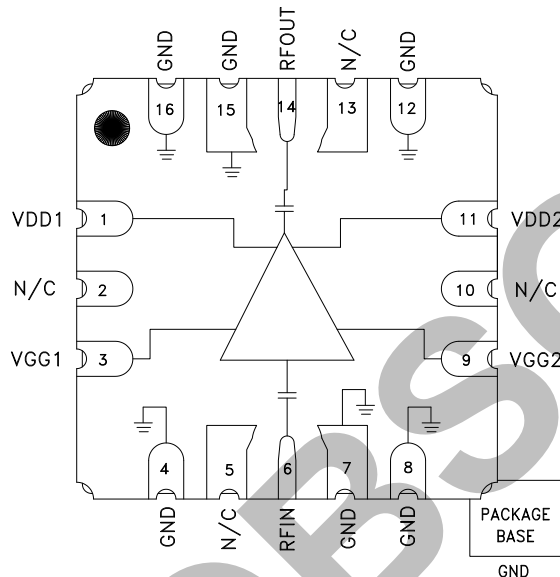

General Description

The HMC5929LS6 is a 4 stage GaAs pHEMT MMIC 1 Watt Power Amplifier which operates between 40 and 43.5 GHz. The amplifier provides 19 dB of gain, +30 dBm of saturated output power, and 15% PAE from a +6V supply. With an excellent IP3 of +36 dBm, the HMC5929LS6 is ideal for high linearity applications in military and space as well as point-to-point and point-to-multi-point radios. The HMC5929LS6 is housed in a ceramic air cavity package which exhibits low thermal resistance and is compatible with surface mount manufacturing techniques. The RF I/Os are internally matched and DC blocked for ease of integration into higher level assemblies.

Electrical Specifications

$T_A = +25^\circ\text{C}$, $V_{dd} = V_{dd1} = V_{dd2} = +6\text{V}$, $I_{dd} = 900\text{ mA}$ [1]

Parameter	Min.	Typ.	Max.	Units
Frequency Range		40 - 43.5		GHz
Gain	16	19		dB
Gain Variation Over Temperature		0.04		dB/°C
Input Return Loss		9		dB
Output Return Loss		12		dB
Output Power for 1 dB Compression (P1dB)	24.5	27		dBm
Saturated Output Power (P _{sat})		30		dBm
Output Third Order Intercept (IP3) ^[2]		36		dBm
Total Supply Current (I _{dd})		900		mA

[1] Adjust V_{gg} between -2 to 0V to achieve I_{dd} = 900 mA typical.

[2] Measurement taken at +6V @ 900 mA, P_{out} / Tone = +18 dBm

**GaAs pHEMT MMIC 1 WATT
POWER AMPLIFIER, 40 - 43.5 GHz**

**Broadband Gain &
Return Loss vs. Frequency**

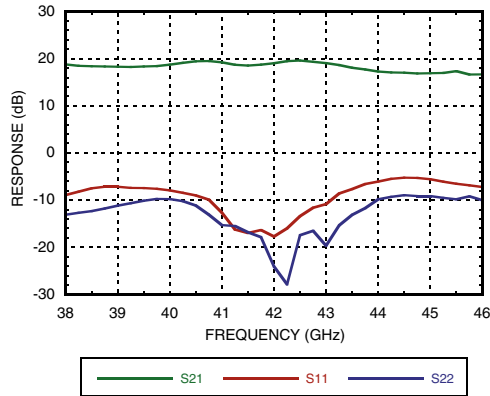

Gain vs. Temperature

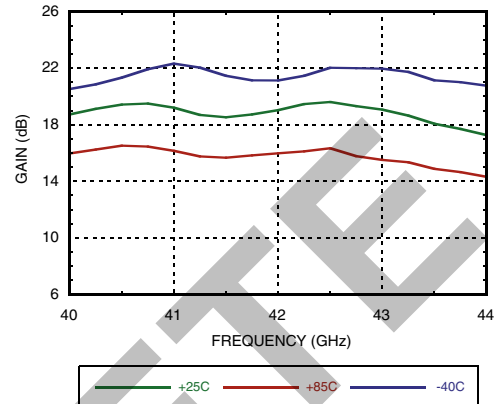

Input Return Loss vs. Temperature

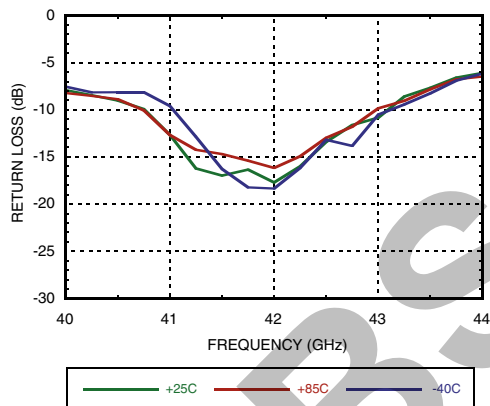

Output Return Loss vs. Temperature

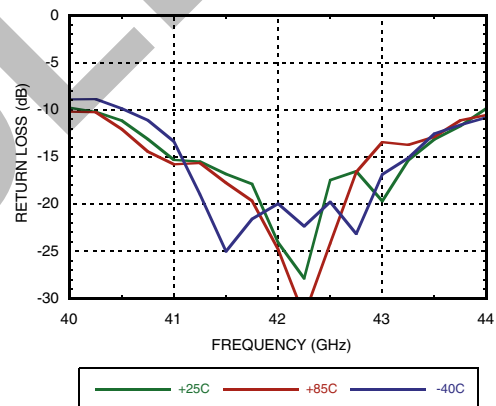

P1dB vs. Temperature

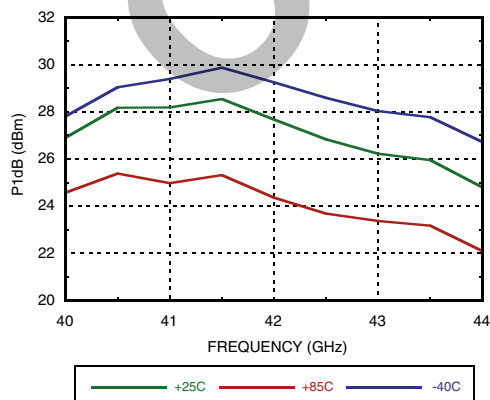

P1dB vs. Supply Voltage

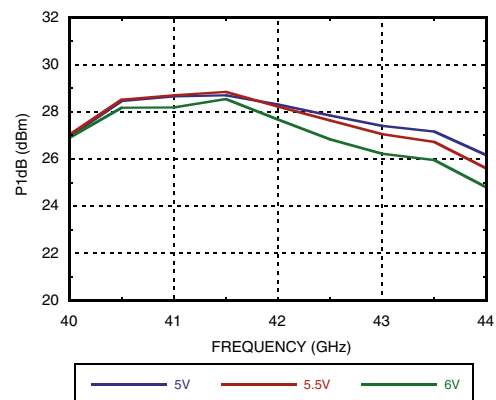

Information furnished by Analog Devices is believed to be accurate and reliable. However, no responsibility is assumed by Analog Devices for its use, nor for any infringements of patents or other rights of third parties that may result from its use. Specifications subject to change without notice. No license is granted by implication or otherwise under any patent or patent rights of Analog Devices. Trademarks and registered trademarks are the property of their respective owners.

For price, delivery, and to place orders: Analog Devices, Inc., One Technology Way, P.O. Box 9106, Norwood, MA 02062-9106 Phone: 781-329-4700 • Order online at www.analog.com Application Support: Phone: 1-800-ANALOG-D

**GaAs pHEMT MMIC 1 WATT
POWER AMPLIFIER, 40 - 43.5 GHz**

Psat vs. Temperature

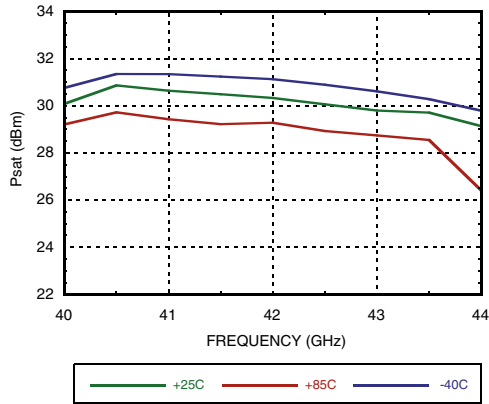

Psat vs. Supply Voltage

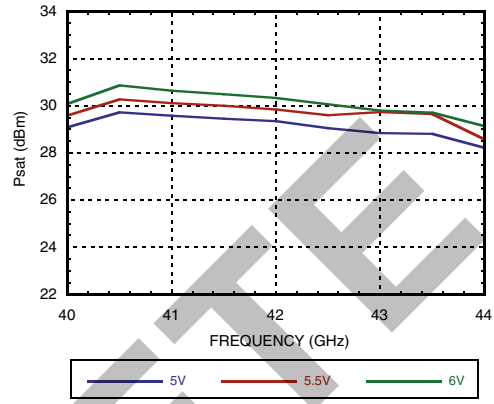

P1dB vs. Supply Current (Idd)

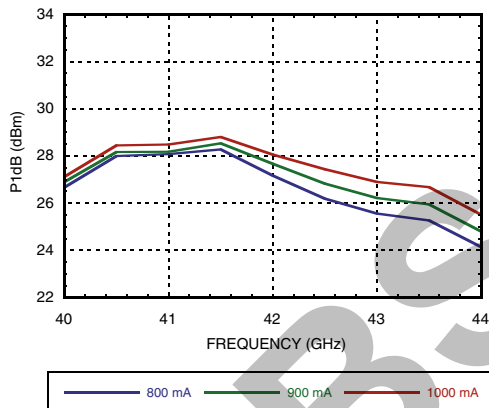

Psat vs. Supply Current (Idd)

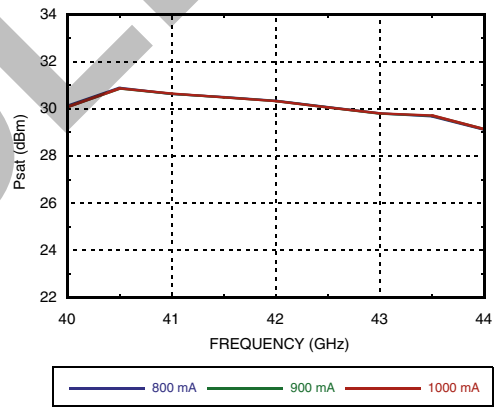

Output IP3 vs. Temperature, Pout/Tone = +18 dBm

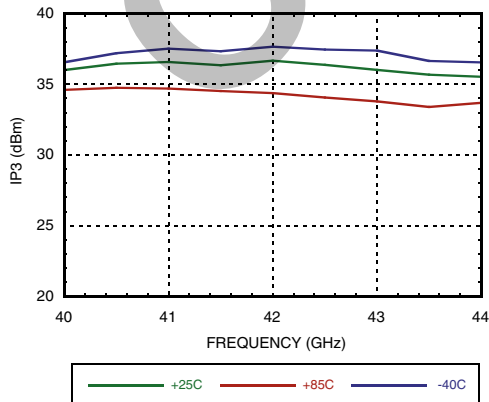

Output IP3 vs. Supply Current, Pout/Tone = +18 dBm

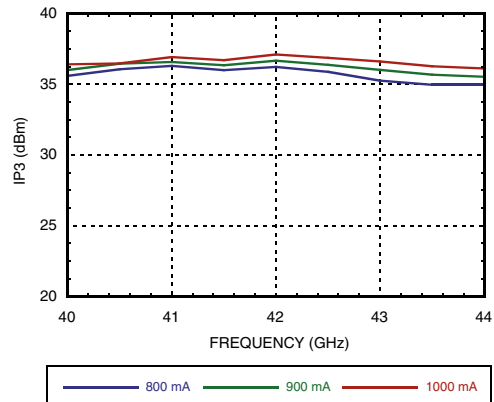

Information furnished by Analog Devices is believed to be accurate and reliable. However, no responsibility is assumed by Analog Devices for its use, nor for any infringements of patents or other rights of third parties that may result from its use. Specifications subject to change without notice. No license is granted by implication or otherwise under any patent or patent rights of Analog Devices. Trademarks and registered trademarks are the property of their respective owners.

For price, delivery, and to place orders: Analog Devices, Inc., One Technology Way, P.O. Box 9106, Norwood, MA 02062-9106 Phone: 781-329-4700 • Order online at www.analog.com Application Support: Phone: 1-800-ANALOG-D

GaAs pHEMT MMIC 1 WATT POWER AMPLIFIER, 40 - 43.5 GHz

Output IP3 vs. Supply Voltage, Pout/Tone = +18 dBm

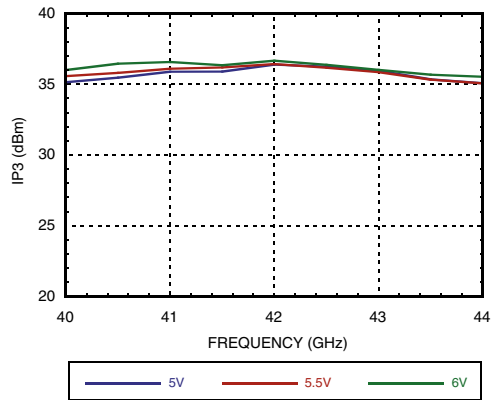

Output IM3 @ Vdd = +5V

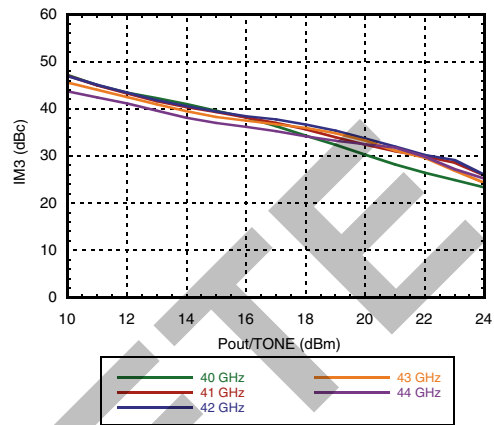

Output IM3 @ Vdd = +5.5V

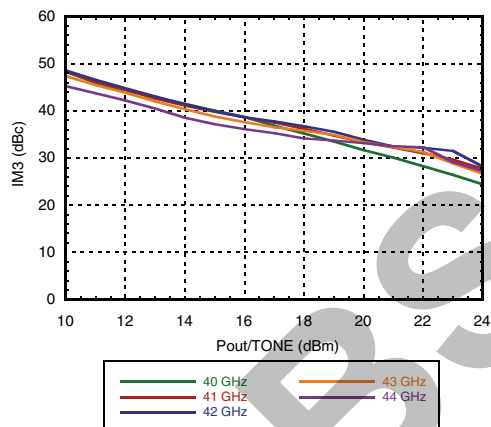

Output IM3 @ Vdd = +6V

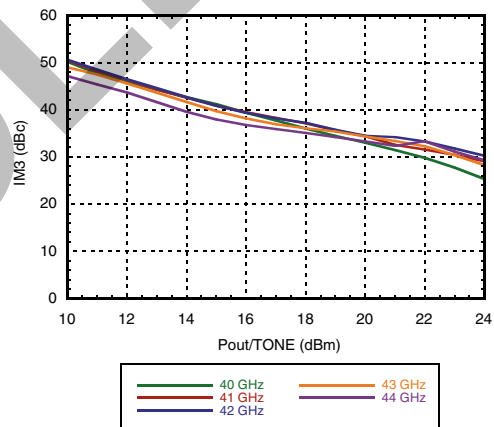

Power Compression @ 41 GHz

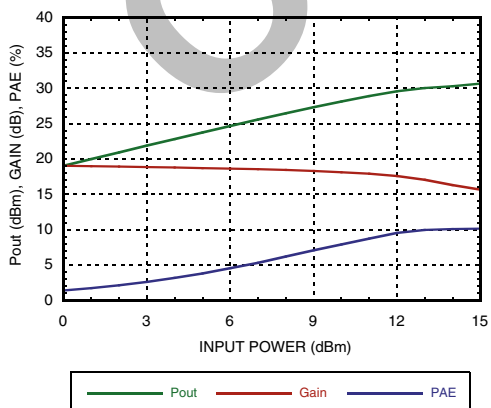

Power Compression @ 42 GHz

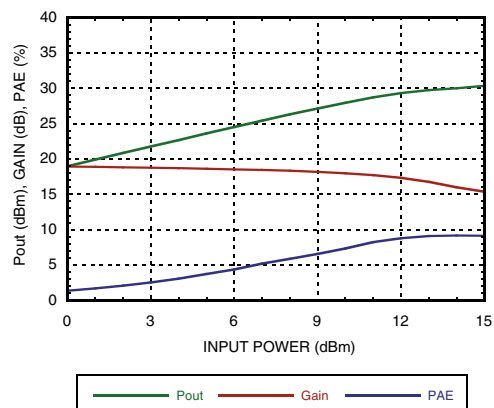

Information furnished by Analog Devices is believed to be accurate and reliable. However, no responsibility is assumed by Analog Devices for its use, nor for any infringements of patents or other rights of third parties that may result from its use. Specifications subject to change without notice. No license is granted by implication or otherwise under any patent or patent rights of Analog Devices. Trademarks and registered trademarks are the property of their respective owners.

For price, delivery, and to place orders: Analog Devices, Inc., One Technology Way, P.O. Box 9106, Norwood, MA 02062-9106 Phone: 781-329-4700 • Order online at www.analog.com Application Support: Phone: 1-800-ANALOG-D

GaAs pHEMT MMIC 1 WATT POWER AMPLIFIER, 40 - 43.5 GHz

Reverse isolation vs. Temperature

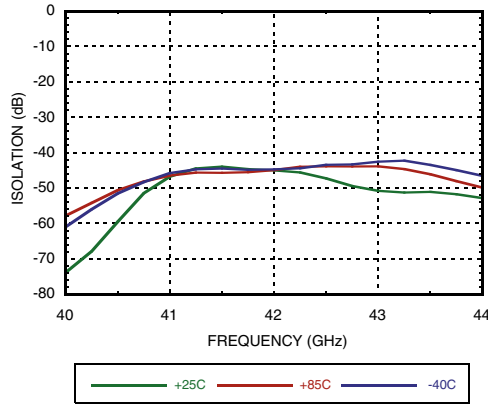

Gain & Power vs. Supply Current @ 41 GHz

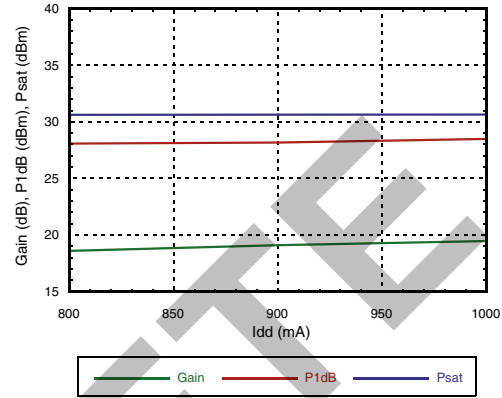

Gain & Power vs. Supply Voltage @ 41 GHz

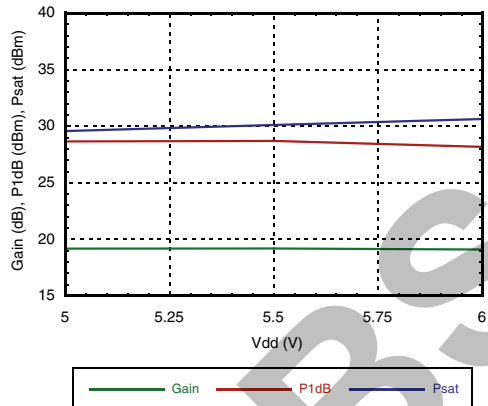

Power Dissipation

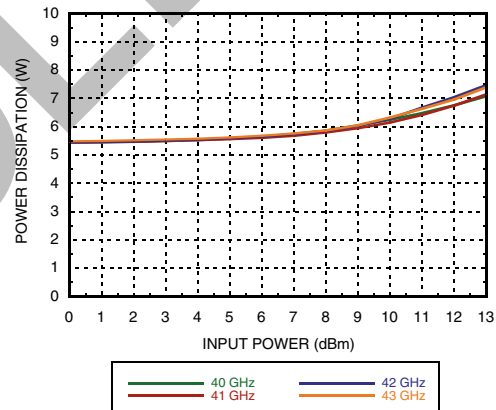

Absolute Maximum Ratings

Drain Bias Voltage (V _{dd})	+7V
RF Input Power (RFIN)	+20 dBm
Channel Temperature	150 °C
Continuous Pdiss (T= 85 °C) (derate 95 mW/°C above 85 °C)	6.2 W
Thermal Resistance (channel to die bottom)	10.5 °C/W
Storage Temperature	-65 to +150 °C
Operating Temperature	-40 to +85 °C
ESD Sensitivity (HBM)	Class 1A

Typical Supply Current vs. V_{dd}

V _{dd} (V)	I _{dd} (mA)
+5.0	900
+5.5	900
+6.0	900

Note: Amplifier will operate over full voltage ranges shown above. V_{gg} adjusted to achieve I_{dd} = 900 mA



ELECTROSTATIC SENSITIVE DEVICE
OBSERVE HANDLING PRECAUTIONS

Information furnished by Analog Devices is believed to be accurate and reliable. However, no responsibility is assumed by Analog Devices for its use, nor for any infringements of patents or other rights of third parties that may result from its use. Specifications subject to change without notice. No license is granted by implication or otherwise under any patent or patent rights of Analog Devices. Trademarks and registered trademarks are the property of their respective owners.

For price, delivery, and to place orders: Analog Devices, Inc., One Technology Way, P.O. Box 9106, Norwood, MA 02062-9106
Phone: 781-329-4700 • Order online at www.analog.com
Application Support: Phone: 1-800-ANALOG-D

**GaAs pHEMT MMIC 1 WATT
POWER AMPLIFIER, 40 - 43.5 GHz**

Outline Drawing

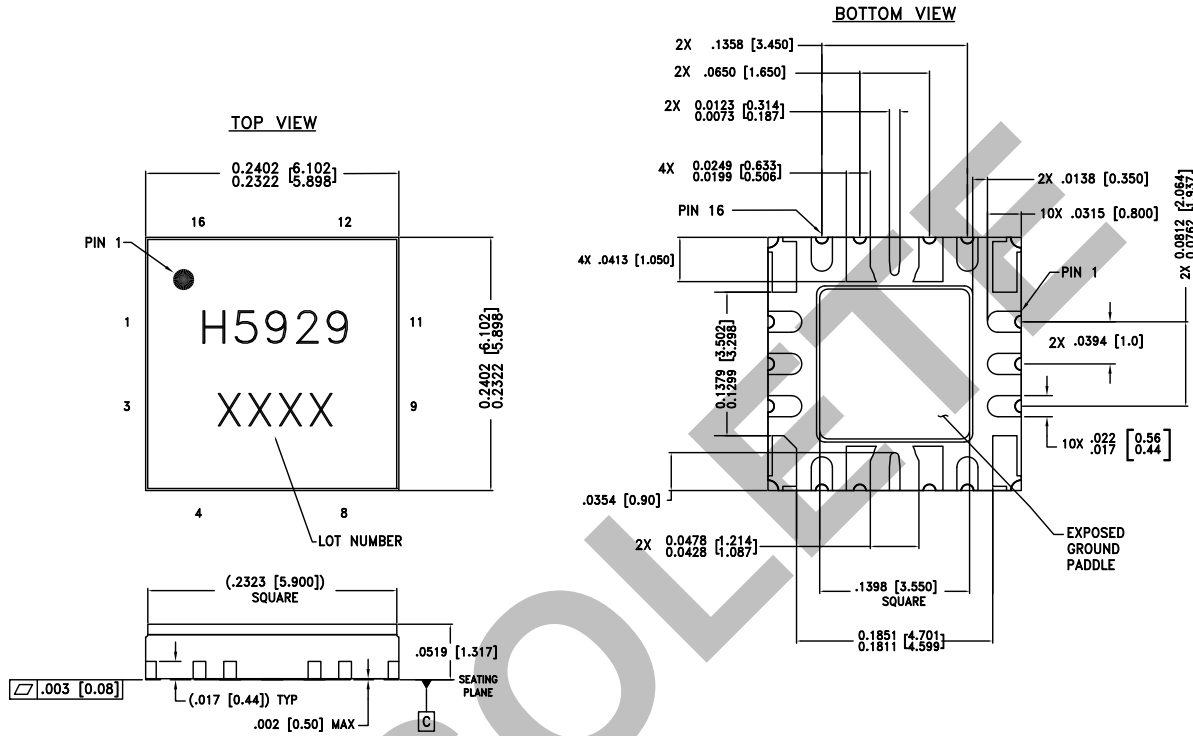

NOTES:

1. PACKAGE BODY MATERIAL: ALUMINA, WHITE
2. LEAD AND GROUND PADDLE PLATING: GOLD OVER NICKEL.
3. CHARACTERS TO BE BLACK INK MARKED WITH .018"MIN to .030"MAX HEIGHT REQUIREMENTS. UTILIZE MAXIMUM CHARACTER HEIGHT BASED ON LID DIMENSIONS AND BEST FIT. LOCATE APPROX. AS SHOWN.
4. ALL GROUND LEADS AND GROUND PADDLE MUST BE SOLDERED TO PCB RF GROUND.
5. REFER TO HITTITE APPLICATION NOTE FOR SUGGESTED PCB LAND PATTERN.

Table 1. Package Information

Part Number	Package Body Material	Lead Finish	MSL Rating	Package Marking ^[1]
HMC5929LS6	ALUMINA, WHITE	Gold over Nickel	N/A	H5929 XXXX

[1] 4-Digit lot number XXXX

GaAs pHEMT MMIC 1 WATT POWER AMPLIFIER, 40 - 43.5 GHz

Pin Descriptions

Pin Number	Function	Description	Interface Schematic
1, 11	Vdd1, Vdd2	Drain bias voltage. External bypass capacitors of 100 pF, 10 nF and 4.7 μF are required for each pin.	
2, 5, 10, 13	N/C	These pins are not connected internally; however, all data shown herein was measured with these pins connected to RF/DC ground externally.	
3, 9	Vgg1, Vgg2	Gate control for PA. Adjust Vgg to achieve recommended bias current. External bypass caps 100 pF, 10 nF and 4.7 μF are required. Apply Vgg bias to either pin 3 or pin 9.	
4, 7, 8, 12, 15, 16	GND	These pins and the exposed ground paddle must be connected to RF/DC ground.	
6	RFIN	This pin is AC coupled and matched to 50 Ohms.	
14	RFOUT	This pin is AC coupled and matched to 50 Ohms.	

Application Circuit

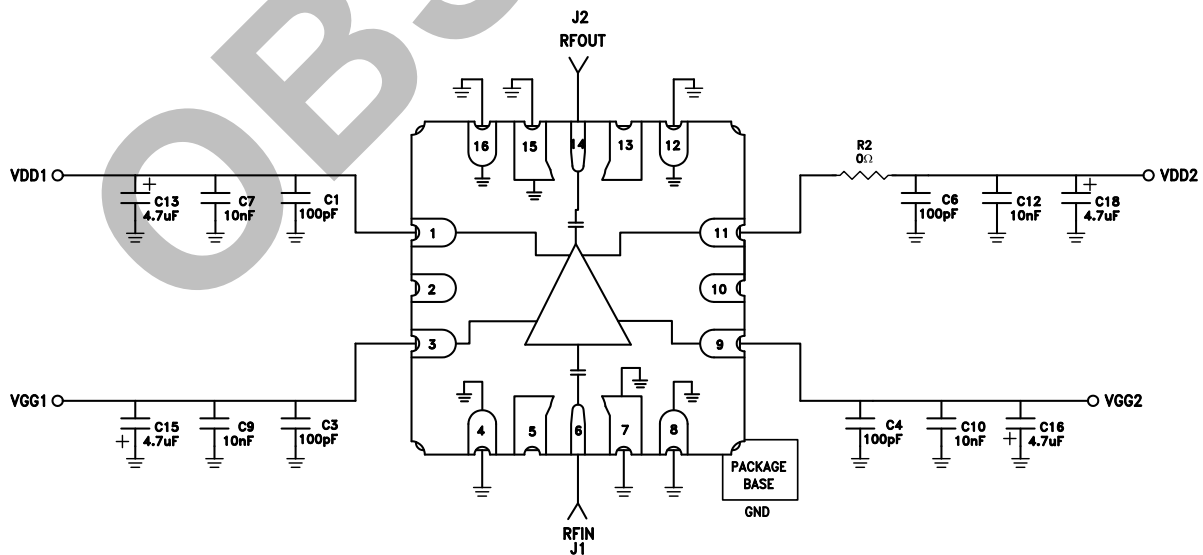

Information furnished by Analog Devices is believed to be accurate and reliable. However, no responsibility is assumed by Analog Devices for its use, nor for any infringements of patents or other rights of third parties that may result from its use. Specifications subject to change without notice. No license is granted by implication or otherwise under any patent or patent rights of Analog Devices. Trademarks and registered trademarks are the property of their respective owners.

For price, delivery, and to place orders: Analog Devices, Inc., One Technology Way, P.O. Box 9106, Norwood, MA 02062-9106
Phone: 781-329-4700 • Order online at www.analog.com
Application Support: Phone: 1-800-ANALOG-D

**GaAs pHEMT MMIC 1 WATT
POWER AMPLIFIER, 40 - 43.5 GHz**

Evaluation PCB

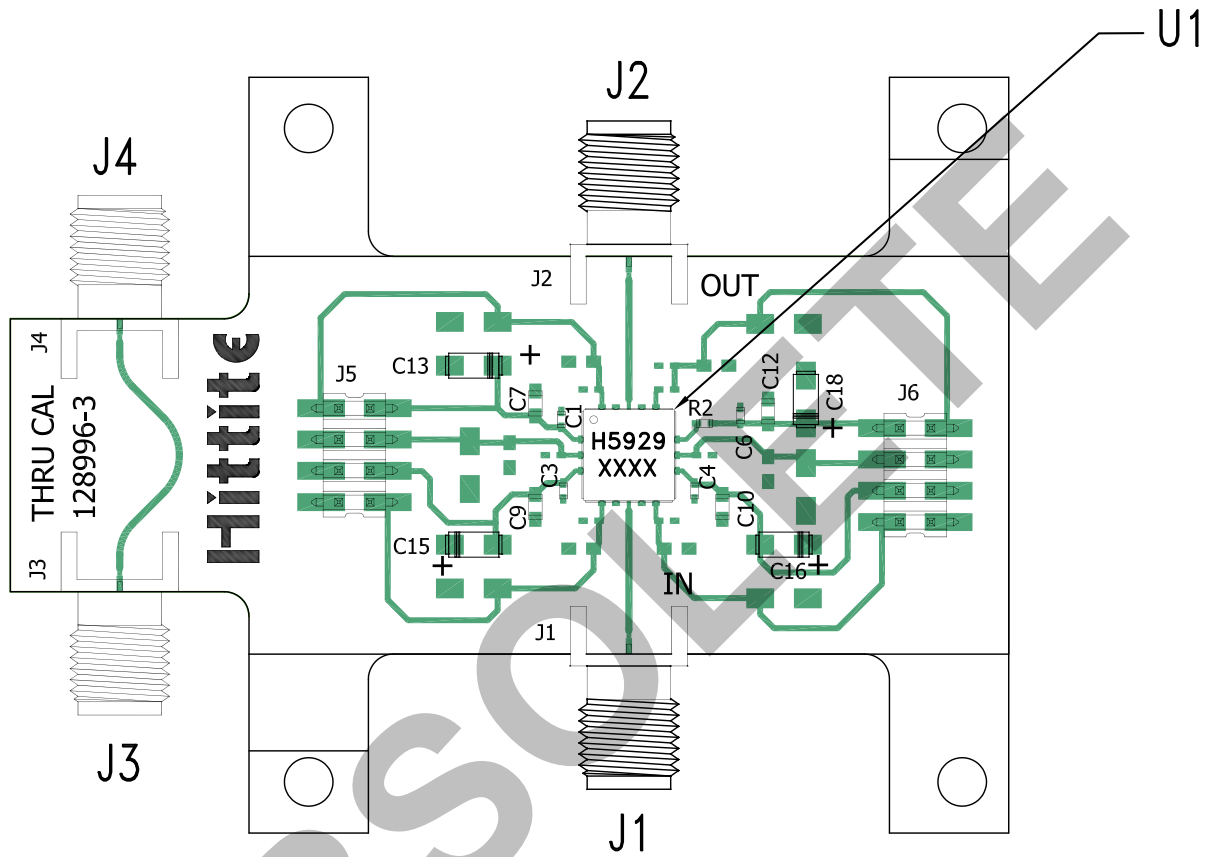

List of Materials for Evaluation PCB EVAL01-HMC5929LS6 [1]

Item	Description
J1 - J4	"K" Connector, SRI
J5, J6	DC Pin
C1, C3, C4, C6	100 pF Capacitor, 0402 Pkg.
C7, C9, C10, C12	10000 pF Capacitor, 0603 Pkg.
C13, C15, C16, C18	4.7 uF Capacitor, Case A Pkg.
R2	0 Ohm Resistor, 0402 Pkg.
U1	HMC5929LS6 Amplifier
PCB [2]	128996 Eval Board

[1] Reference this number when ordering complete evaluation PCB

[2] Circuit Board Material: Rogers 4350

The circuit board used in the application should use RF circuit design techniques. Signal lines should have 50 Ohm impedance while the package ground leads and exposed paddle should be connected directly to the ground plane similar to that shown. A sufficient number of via holes should be used to connect the top and bottom ground planes. The evaluation board should be mounted to an appropriate heat sink. The evaluation circuit board shown is available from Hittite upon request.