

Dual, 2-Wire Hall-Effect Sensor Interface with Analog and Digital Outputs

MAX9621

ABSOLUTE MAXIMUM RATINGS

BAT to GND.....	-0.3V to +60V
ISET to BAT.....	-2.0V to +0.3V
IN1, IN2 to GND.....	-3V to lower of +60V or (VBAT + 1V)
AOUT1, DOUT1, AOUT2, DOUT2, SLEEP to GND.....	-0.3V to +6V
Short-Circuit Duration AOUT1, DOUT1, AOUT2, DOUT2 to GND or to 5.5V (individually).....	Continuous
Current In to IN1, IN2.....	±100mA
Current In to Any Other Pin.....	±20mA

Continuous Power Dissipation for a Single-Layer Board (TA = +70°C)	
10-Pin μMAX (derate 5.6mW/°C) above +70°C.....	444.4mW
Continuous Power Dissipation for a Multilayer Board (TA = +70°C)	
10-Pin μMAX (derate 8.8mW/°C) above +70°C.....	707.3mW
Operating Temperature Range.....	-40°C to +125°C
Junction Temperature.....	+150°C
Storage Temperature Range.....	-65°C to +160°C
Lead Temperature (soldering, 10s).....	+300°C
Soldering Temperature (reflow).....	+260°C

Stresses beyond those listed under "Absolute Maximum Ratings" may cause permanent damage to the device. These are stress ratings only, and functional operation of the device at these or any other conditions beyond those indicated in the operational sections of the specifications is not implied. Exposure to absolute maximum rating conditions for extended periods may affect device reliability.

DC ELECTRICAL CHARACTERISTICS

(VBAT = 13.6V, VSLEEP = 5V, IN1 = IN2 = no connection, RSET = 61.9kΩ to BAT, RPU = 10kΩ at DOUT1 and DOUT2, RL = 5kΩ to GND at AOUT1 and AOUT2, unless otherwise noted, TA = -40°C to +125°C. Typical values are at TA = +25°C.) (Note 1)

PARAMETER	SYMBOL	CONDITIONS	MIN	TYP	MAX	UNITS
GENERAL						
BAT Supply Range	VBAT	Guaranteed by functional test of I _{IH} , I _{IL} , and GEI	5.5		18	V
BAT Supply Current	IBAT	Normal mode			1	mA
	ISD	VSLEEP = 0V		1	10	μA
Hall Input Voltage Dropout	V _{DO}	VBAT = 5.5V, at IN1 and IN2, I _{IN} = -14mA		0.59	1.26	V
		VBAT = 5.5V, at IN1 and IN2, I _{IN} = -20mA		0.86	1.86	
ESD Protection		Machine Model		±200		V
		Human Body Model		±2000		
INPUT THRESHOLDS FOR DOUT1, DOUT2 SWITCHING						
Input Current for Output High (Note 2)	I _{IH}	RSET = 95.3kΩ			-7.7	mA
		RSET = 52.3kΩ			-14	
Input Current for Output Low (Note 2)	I _{IL}	RSET = 95.3kΩ	-5			mA
		RSET = 52.3kΩ	-9			
Input Current Hysteresis for High/Low Detection	I _{IN_HYS}	Peak-to-peak as percent of average high/low threshold (Note 2)		8		%
Channel-to-Channel Input Threshold Variation		High threshold		0.02		mA
		Low threshold		0.02		
Short-Circuit Current Limit	I _{SC}	A short to GND is not a sustained condition, Hall input reverts to -50μA when detected (Note 2)	-20			mA
AOUT1, AOUT2 ANALOG OUTPUTS						
Current Gain for AOUT1 and AOUT2 Outputs	G _I	-18mA ≤ I _{IN} ≤ -2mA		0.05		mA/mA
Current Gain Error for AOUT1 and AOUT2 Outputs	G _{EI}	I _{IN} = -5mA, -14mA		0.2	±1.7	%

Dual, 2-Wire Hall-Effect Sensor Interface with Analog and Digital Outputs

MAX9621

DC ELECTRICAL CHARACTERISTICS (continued)

(V_{BAT} = 13.6V, V_{SLEEP} = 5V, IN1 = IN2 = no connection, R_{SET} = 61.9kΩ to BAT, R_{PU} = 10kΩ at DOUT1 and DOUT2, R_L = 5kΩ to GND at AOUT1 and AOUT2, unless otherwise noted, T_A = -40°C to +125°C. Typical values are at T_A = +25°C.) (Note 1)

PARAMETER	SYMBOL	CONDITIONS	MIN	TYP	MAX	UNITS
Input Referred Current Offset	I _{OS}	Inferred from measurements at I _{IN} = -5mA, -14mA	-120		+120	μA
AOUT_ Dropout Voltage		V _{BAT} = 5.5V, for 5% current reduction	I _{IN} = -14mA	0.85	1.6	V
			I _{IN} = -20mA	1.09	1.75	
AOUT_ Output Impedance				500		MΩ
LOGIC I/O (DOUT1, DOUT2)						
Output-Voltage Low DOUT1, DOUT2	V _{OL}	Sink current = 1mA			0.4	V
Three-State Output Current DOUT1, DOUT2	I _{OZ}	V _{SLEEP} = 0V, 0V ≤ V _{DOUT_} ≤ 5V			±1	μA
SLEEP						
Input-Voltage High	V _{IH}		2.0			V
Input-Voltage Low	V _{IL}				0.8	V
Input Resistance to GND	R _{IN}		50	100		kΩ
AC TIMING CHARACTERISTICS						
Shutdown Delay from SLEEP Low to IN_ Shutoff	t _{SHDN}	I _{IH} = -14mA to GND, time from SLEEP low to IN_ drop 500mV, C _L = 20pF	33	40	46	μs
IN_, Blanking Time at Hall Sensor Power-Up	t _{BL}	I _{IH} = -14mA to GND, time from V _{IN_} = 500mV until DOUT_ high, C _L = 20pF (Notes 2, 3)	76	89	103	μs
IN_, Current Ramp Rate After Turn-On	t _{TRAMP}	IN_ = GND (Note 2)	3.6	5	6.7	mA/μs
Delay from IN_ to DOUT_ (Filter Delay)	t _{DEL}	From I _{IH} to I _{IL} or from I _{IL} to I _{IH} , C _L = 20pF, Figure 1 (Note 2)	10.8	13.5	16	μs
Delay Difference Between Rising and Falling Edges of Both Channels	t _{DM}	CHALL-BYPASS = 0.01μF, I _{IH} = -11.5mA and I _{IL} = -7.5mA, C _L = 20pF		1		μs
Delay Difference Between Channels	t _{CC}	CHALL-BYPASS = 0.01μF, I _{IH} = -11.5mA and I _{IL} = -7.5mA, C _L = 20pF		500		ns
Maximum Frequency on Hall Inputs	f _{MAX}	CHALL-BYPASS = 0.01μF, I _{IH} = -11.5mA and I _{IL} = -7.5mA, C _L = 20pF (Note 2)	34	39		kHz
Maximum Analog Output Current During Short-to-GND Fault	I _{MAO}			-1.4		mA
IN_ Pulse Length Rejected by Filter to DOUT_	P _R	Figure 2 (Note 2)	7.8	11.5	14.6	μs

Note 1: All DC specifications are 100% production tested at T_A = +25°C. AC specifications are guaranteed by design at T_A = +25°C.

Note 2: Parameters that change with the value of the R_{SET} resistor: I_{IH}, I_{IL}, I_{IN_HYS}, I_{SC}, t_{BL}, t_{TRAMP}, t_{DEL}, f_{MAX}, and P_R.

Note 3: Following power-up or startup from sleep mode, the start of the blanking period is delayed 20μs.

Dual, 2-Wire Hall-Effect Sensor Interface with Analog and Digital Outputs

Timing Diagrams

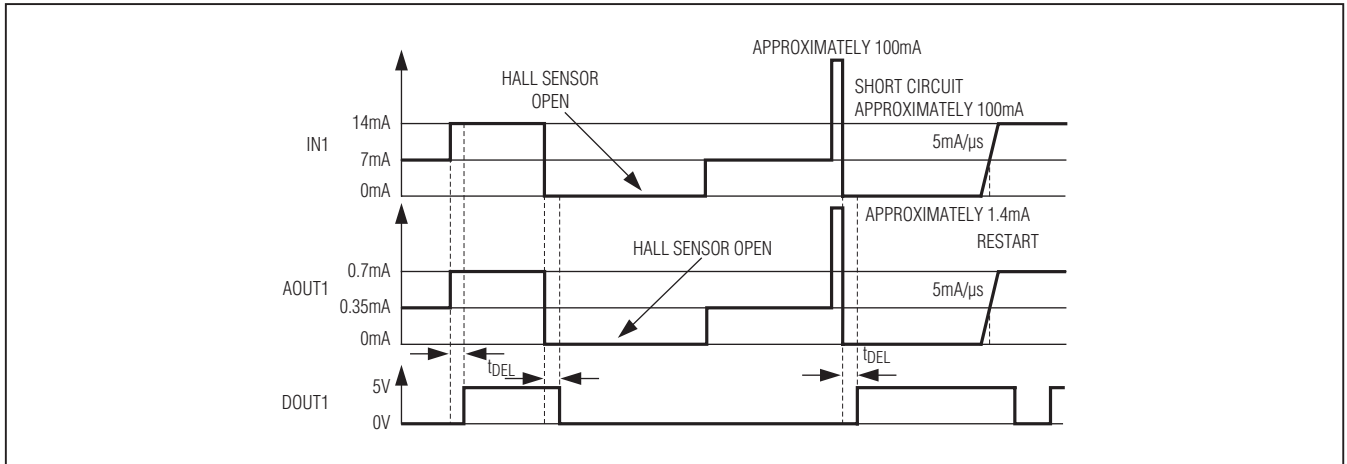

Figure 1. Timing Diagram

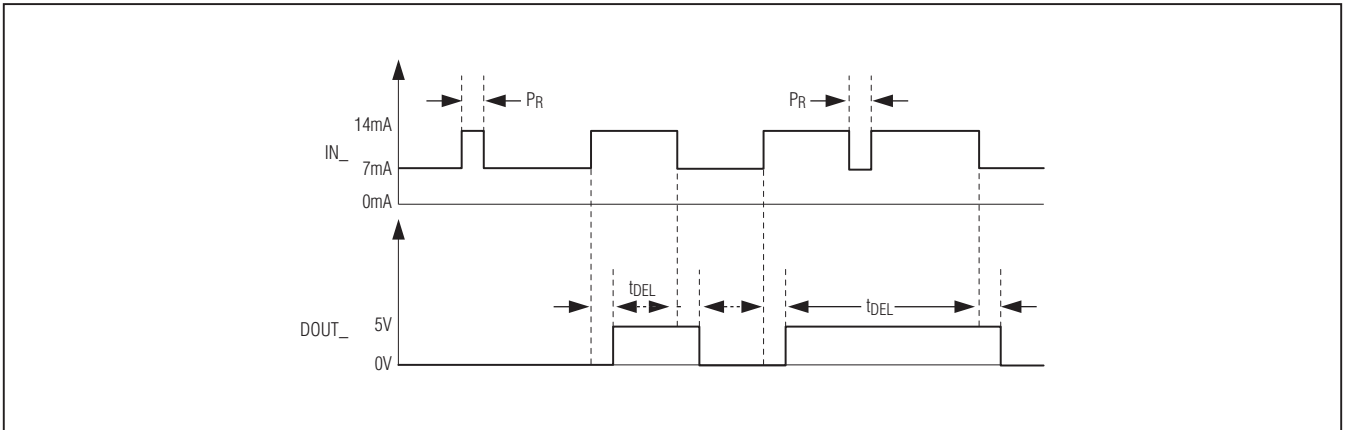

Figure 2. Hall Input Pulse Rejection

Dual, 2-Wire Hall-Effect Sensor Interface with Analog and Digital Outputs

Typical Operating Characteristics

($V_{BAT} = 13.6V$, $R_{SET} = 61.9k\Omega$, $R_L = 5k\Omega$ to GND at AOUT_, $V_{SLEEP} = 5V$, $T_A = +25^\circ C$, unless otherwise noted.)

MAX9621

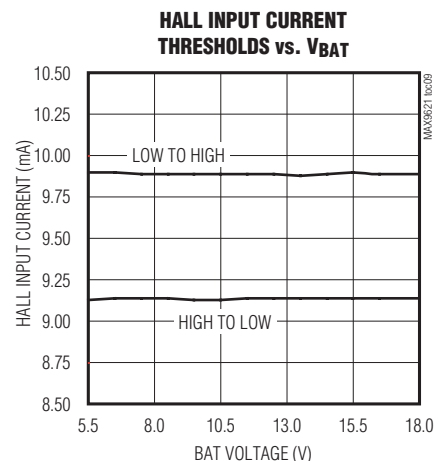
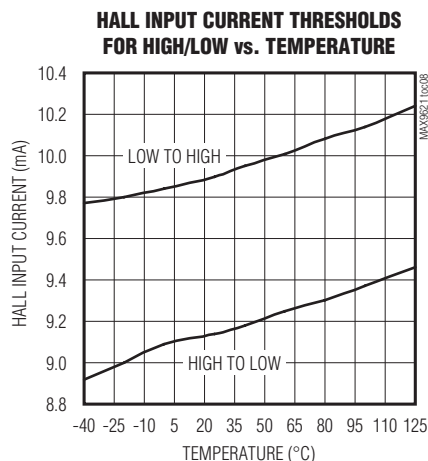
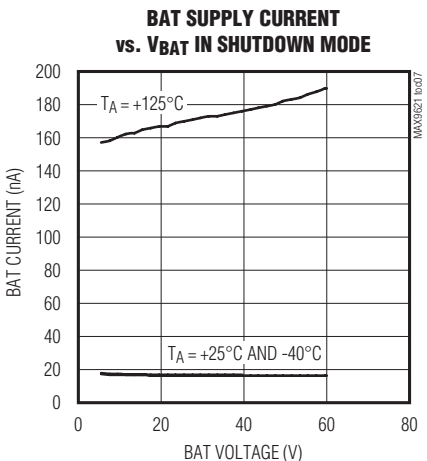
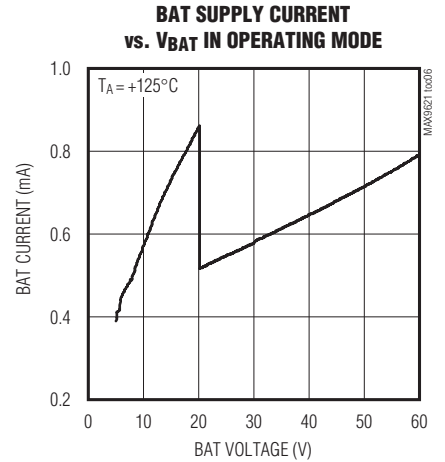
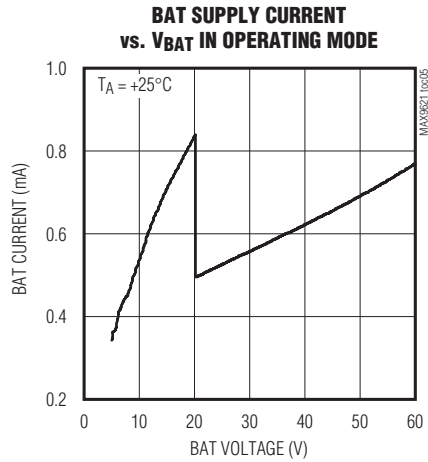
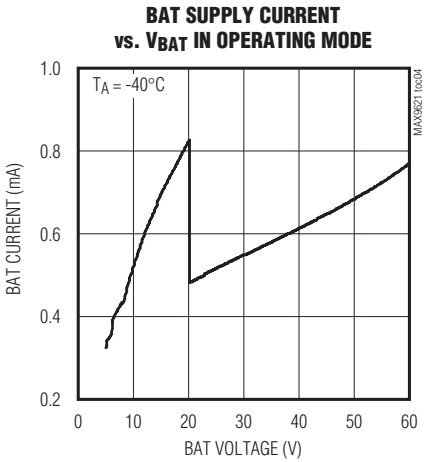
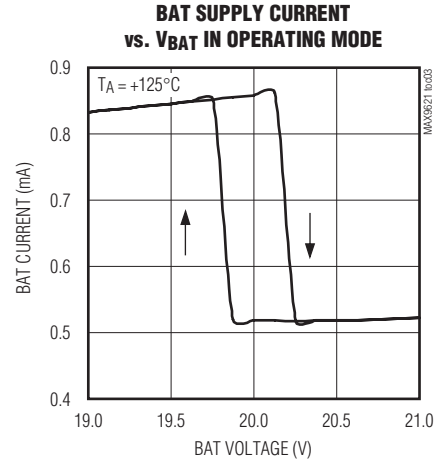
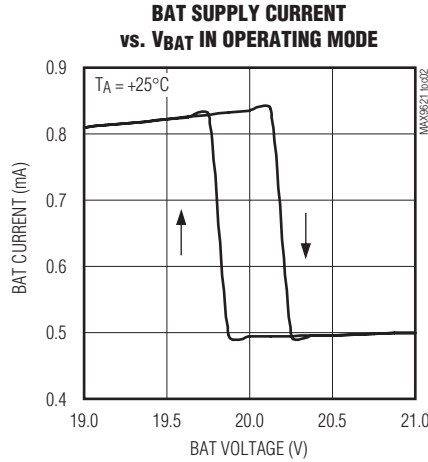
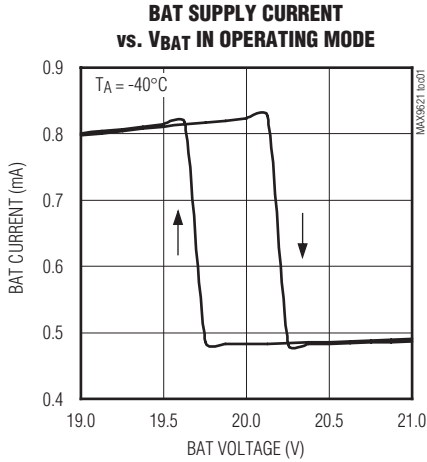

Dual, 2-Wire Hall-Effect Sensor Interface with Analog and Digital Outputs

Typical Operating Characteristics (continued)

($V_{BAT} = 13.6V$, $R_{SET} = 61.9k\Omega$, $R_L = 5k\Omega$ to GND at AOUT_, $V_{SLEEP} = 5V$, $T_A = +25^\circ C$, unless otherwise noted.)

HALL INPUT CURRENT THRESHOLDS vs. ISET RESISTOR

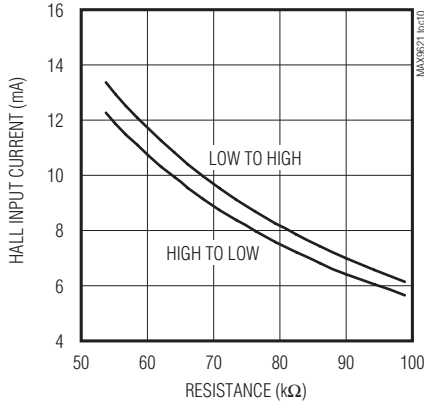

INPUT BLANKING TIME AT RESTART FROM SLEEP MODE (OR POWER-UP) vs. TEMPERATURE

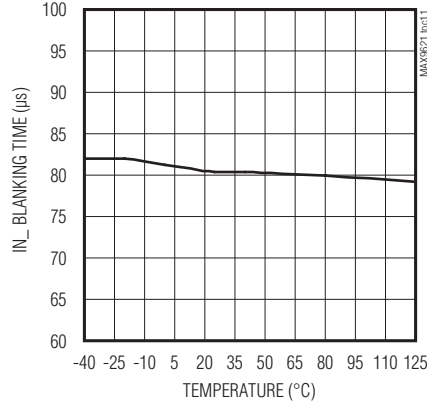

IN-CURRENT RAMP RATE AFTER TURN-ON vs. TEMPERATURE

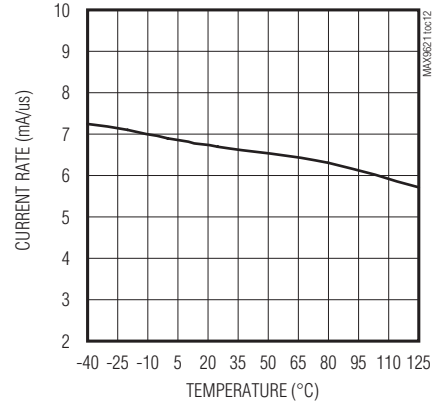

DELAY FROM IN_ TO DOUT_ (FILTER DELAY) vs. TEMPERATURE

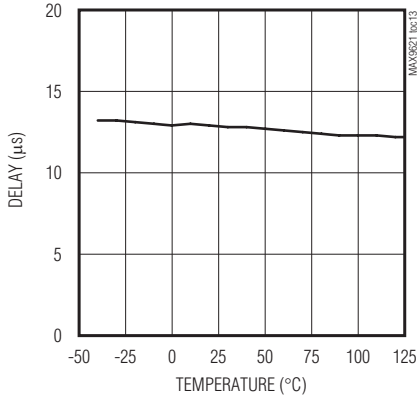

DELAY DIFFERENCE BETWEEN CHANNELS vs. TEMPERATURE

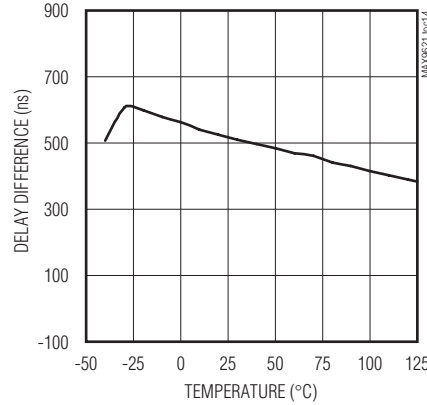

MAXIMUM FREQUENCY ON HALL INPUTS vs. TEMPERATURE

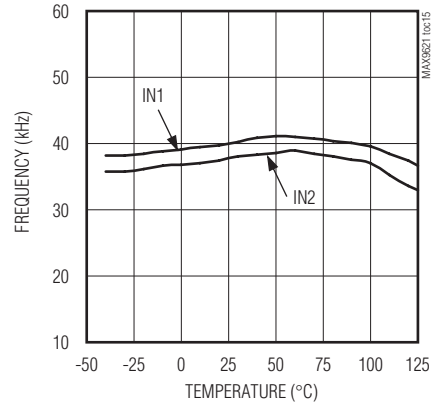

IN_ PULSE LENGTH REJECTED BY FILTER TO DOUT_ vs. TEMPERATURE

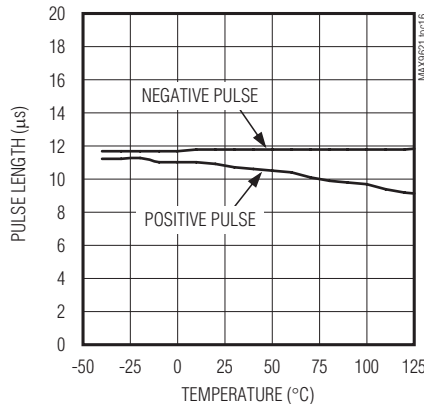

INPUT DROPOUT VOLTAGE vs. TEMPERATURE

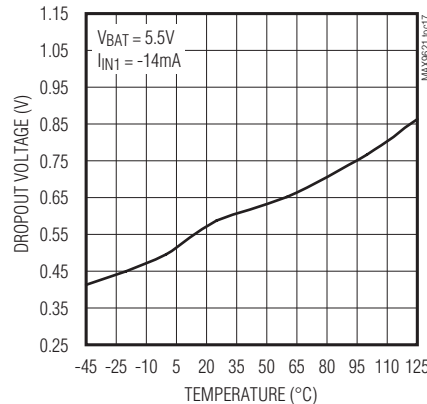

INPUT DROPOUT VOLTAGE vs. VBAT

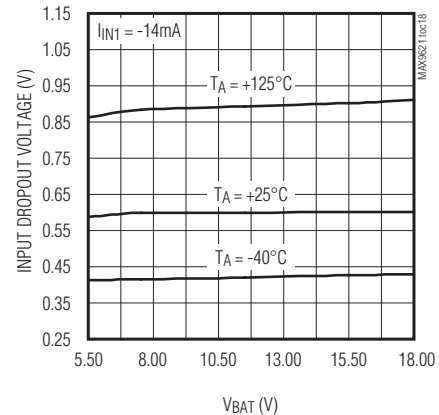

Dual, 2-Wire Hall-Effect Sensor Interface with Analog and Digital Outputs

MAX9621

Typical Operating Characteristics (continued)

($V_{BAT} = 13.6V$, $R_{SET} = 61.9k\Omega$, $R_L = 5k\Omega$ to GND at $AOUT_+$, $V_{SLEEP} = 5V$, $T_A = +25^\circ C$, unless otherwise noted.)

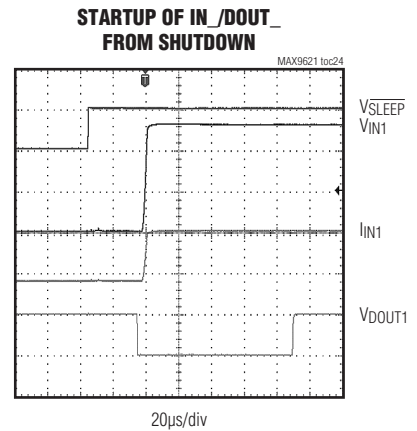
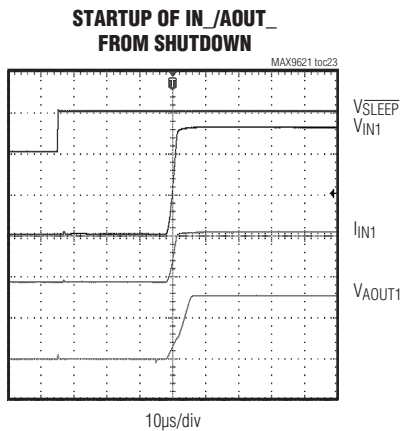
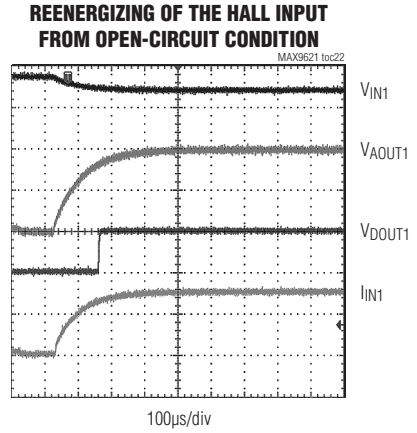
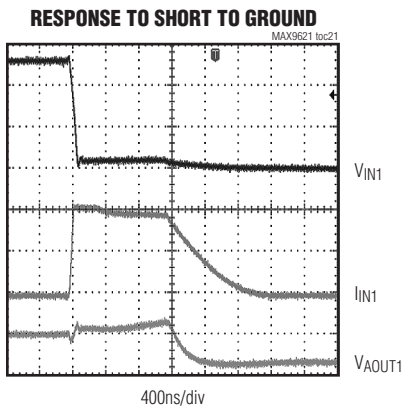
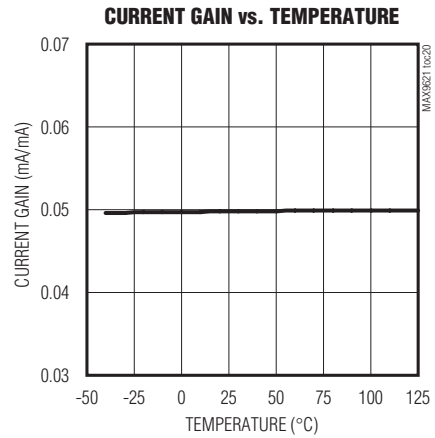
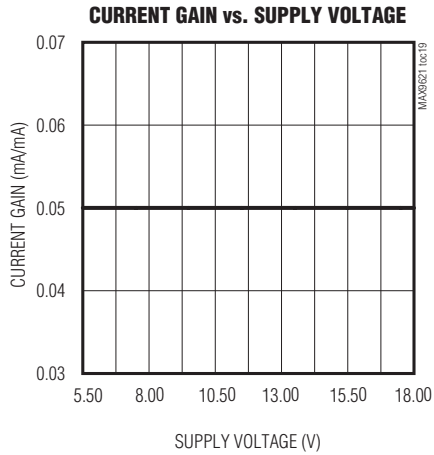

Dual, 2-Wire Hall-Effect Sensor Interface with Analog and Digital Outputs

Pin Configuration

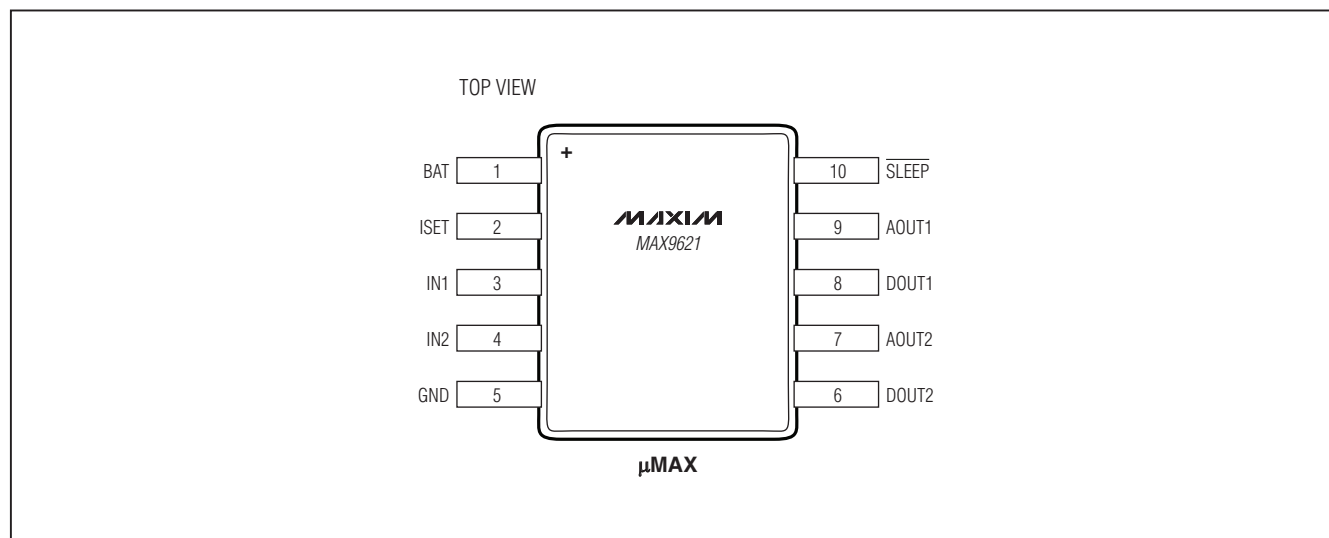

Pin Description

PIN	NAME	FUNCTION
1	BAT	Battery Power Supply. Connect to the positive supply through an external reverse-polarity diode. Bypassed to GND with a 0.1µF capacitor.
2	ISET	Current Setting Input. Place a 1% resistor (R _{SET}) between BAT and ISET to set the desired input current threshold range for the DOUT_ outputs. See the <i>Typical Operating Characteristics</i> section for the correct value of R _{SET} for the desired range. Make no other connections to this pin. All routing must have low parasitic capacitance. See the <i>Input Current Thresholds and Short to Ground</i> section.
3	IN1	Hall-Effect Sensor Input 1. Supplies current to the Hall sensor and monitors the current level drawn to determine the high/low state of the sensor. Bypass to GND with a 0.01µF capacitor. Connect an unused input to BAT pin.
4	IN2	Hall-Effect Sensor Input 2. Supplies current to the Hall sensor and monitors the current level drawn to determine the high/low state of the sensor. Bypass to GND with a 0.01µF capacitor. Connect an unused input to BAT pin.
5	GND	Ground

Dual, 2-Wire Hall-Effect Sensor Interface with Analog and Digital Outputs

MAX9621

Pin Description (continued)

PIN	NAME	FUNCTION
6	DOUT2	Open-Drain Output. Signal translated from Hall sensor 2. DOUT2 is high when the current flowing out of IN2 exceeds the input current threshold high, and is low when less than the input current threshold low. See Table 1 for output response to operating conditions.
7	AOUT2	Analog Current Output. Mirrors the current to the corresponding Hall sensor at IN2. When IN2 has been shut down due to a short to GND a current of zero is supplied to AOUT2. See Table 1 for output response to operating conditions. To obtain a voltage output, connect a resistor from AOUT_ to ground.
8	DOUT1	Open-Drain Output. Signal translated from Hall sensor 1. DOUT1 is high when the current flowing out of IN1 exceeds the input current threshold high, and is low when less than the input current threshold low. See Table 1 for output response to operating conditions.
9	AOUT1	Analog Current Output. Mirrors the current to the corresponding Hall sensor at IN1. When IN1 has been shut down due to a short to GND a current of zero is supplied to AOUT1. See Table 1 for output response to operating conditions. To obtain a voltage output, connect a resistor from AOUT_ to ground.
10	$\overline{\text{SLEEP}}$	Sleep Mode Input. The part is placed in sleep mode when the $\overline{\text{SLEEP}}$ input is low for more than 40 μs . If the $\overline{\text{SLEEP}}$ input is low for less than 20 μs and then goes high, the part restarts any Hall input that has been shut off due to a detected short to GND. Any Hall input that is operational is not affected when $\overline{\text{SLEEP}}$ is cycled low for less than 20 μs . There is an internal 100k Ω pulldown resistance to GND.

Detailed Description

The MAX9621, an interface between two 2-wire Hall-effect sensors and a low-voltage microprocessor, supplies and monitors current through IN1 and IN2 to two Hall sensors.

The MAX9621 complements Maxim's existing family of Hall-effect sensor interfaces that includes the MAX9921.

The MAX9621 provides two independent channels with two outputs for each channel, a digital output, and an analog output. The digital outputs (DOUT1 and DOUT2) are open-drain and indicate a logic level that corresponds to the Hall sensor status. DOUT1 or DOUT2 outputs high when the current out of IN1 or IN2, respectively, exceeds the high-input current threshold. DOUT1 or DOUT2

outputs low when the current flowing out of IN1 or IN2, respectively, is lower than the low-input current threshold. DOUT1 and DOUT2 provide a time domain output filter for robust noise immunity. See Figure 2.

The analog outputs (AOUT1 and AOUT2) mirror the current flowing out to the corresponding inputs IN1 and IN2 with a nominal gain of 0.05mA/mA.

Hall Sensor Protection from Supply Transients

The MAX9621 protects the hall sensors from supply transients by shutting off current at IN1 and IN2 when the BAT voltage is 18V. The digital outputs go low and analog outputs have zero output current. When VBAT returns to the proper operating range, both inputs restart following a blanking cycle.

Dual, 2-Wire Hall-Effect Sensor Interface with Analog and Digital Outputs

Table 1. AOUT_/DOUT_ Truth Table

CONDITION	AOUT_	DOUT_
IN_ Short to GND	0	High-Z
IN_ Short to BAT or IN_ Open	0	Low*
SLEEP Low	0	High-Z
V _{BAT} > 18V	0	Low*

*If IN_ is already shorted to BAT or open during power-up, DOUT_ goes to high-Z until IN_ is loaded.

Hall Input Short-to-Battery Condition

The MAX9621 interprets a short to battery when the voltage at IN1 or IN2 is higher than V_{BAT} - 100mV. The digital outputs go low and the analog outputs are set to zero output current. If IN1 or IN2 is more than 1V above V_{BAT}, it back-drives current into BAT. The MAX9621 restarts the Hall inputs when the Hall input is loaded again.

Hall Input Short to Ground

The Hall input short-to-ground fault is effectively a latched condition if the input remains loaded by the Hall switch. The current required to power the Hall switch is shut off and only a 50μA pullup current remains. The Hall input can be manually reenergized or it can be reenergized by the μP. A 10μs to 20μs negative pulse at SLEEP restarts with a blanking cycle any Hall input that has been shut down due to the short-to-ground condition. During startup or restart, it is possible for a Hall input to charge up an external capacitance of 0.02μF without

tripping into a short-to-ground latched state. During the short-to-ground fault, DOUT1 and DOUT2 are high impedance (pulled high by the pullup resistors), while AOUT1 and AOUT2 are set to zero-output current.

Manual Method for Reenergizing Hall Sensor and Means for Diagnosing an Intermittent Hall Sensor Connection

Figure 3 shows the behavior of the MAX9621 when a Hall input is open. Figure 4 shows the behavior of the MAX9621 when the open input is reconnected to a Hall sensor. Figures 3 and 4 demonstrate how a short-to-ground Hall input can be reset. Resetting a short-to-ground Hall input involves three steps:

- 1) Relieve the short to ground at the Hall sensor.
- 2) Disconnect the Hall input from the Hall sensor (open-input fault condition).
- 3) Reconnect the Hall input to the Hall sensor.

The MAX9621 restarts the Hall input with a blanking cycle. If the Hall input is disconnected from the Hall sensor for 10ms, it allows the Hall input to be pulled up by the 50μA pullup current to register the open-input fault condition. Reconnecting the Hall input to the Hall sensor restarts the Hall input with a blanking cycle. This provides a manual means of reenergizing a Hall input without having to resort to the μP to restart it. This also demonstrates the behavior of an intermittent connection to a Hall sensor.

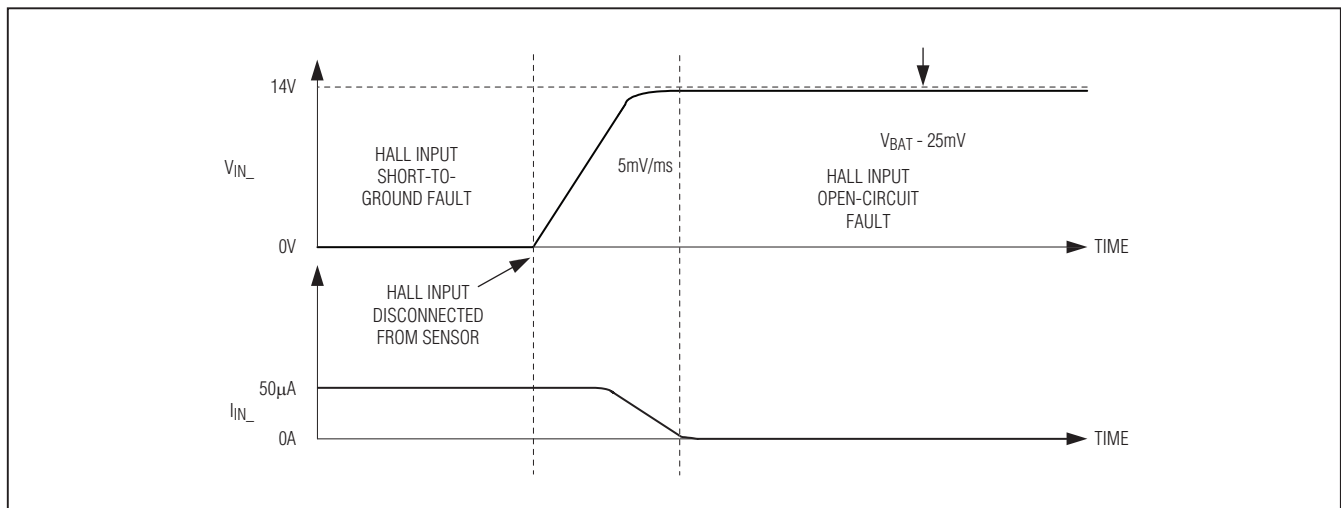

Figure 3. Hall Input Ramps to Open-Circuit Fault When a Short to Ground Is Relieved

Dual, 2-Wire Hall-Effect Sensor Interface with Analog and Digital Outputs

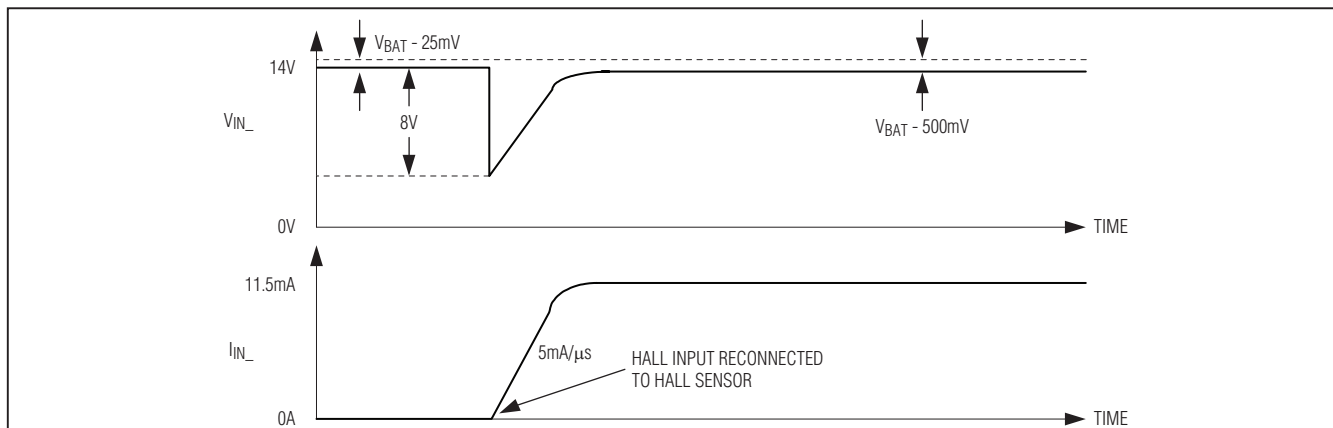

Figure 4. Hall Input Reenergized When Open Input Is Reconnected to Hall Sensor

Sleep Mode Input ($\overline{\text{SLEEP}}$)

The MAX9621 features an active-low $\overline{\text{SLEEP}}$ input. Pull $\overline{\text{SLEEP}}$ low for more than 40 μs to put the device into sleep mode for power saving. In sleep mode, the DOUT1 and DOUT2 outputs are high impedance and are pulled high by pullup resistors. AOUT1 and AOUT2 are set to zero-output current.

Hall Input Restart

When an input has been shut down due to a short to ground, cycle $\overline{\text{SLEEP}}$ for 10 μs to 20 μs to restart the input. If the other input is operational it is not affected. The restart happens on the rising edge of $\overline{\text{SLEEP}}$.

Input Current Thresholds and Short to Ground

The input current high and low thresholds that determine the logic level of the digital outputs are adjusted by changing the RSET value. When the RSET value changes, the following parameters change as well: IIN_HYS, ISC, tBL, tRAMP, tDEL, fMAX, and PR.

I_{IH}, I_{IL}, I_{IN_HYS}, ISC, tRAMP, and fMAX are inversely proportional to RSET and decrease as RSET increases. This inverse relationship is linear. For example, a 10% change in (1/RSET) results in a 10% change in current parameters. Conversely, time and delay parameters are linear and directly proportional to RSET, and a 10% change in RSET results in a 10% change in time parameters.

The difference between the maximum and minimum threshold current limits is the min/max limit spread, which is greater than the threshold hysteresis. The min/max spread and the hysteresis both change by the same percentage as the mean of the threshold current limits. The following equation is useful for finding the mean of the threshold current limits given a value of RSET resistance:

$$I = I_0 + \frac{1}{R \times m} \quad (I < 0)$$

I is the mean of the threshold current limits, R is the value of the RSET resistance in k Ω , the constant I₀ = 0.03717mA, and the constant m = -0.001668 (1/(k Ω x mA)).

The following equation is useful for finding the value of RSET resistance given a mean of the threshold current limits:

$$Y = Y_0 + m \times I \quad (I < 0)$$

$$R = \frac{1}{Y}$$

$$Y_0 = 6.2013 \times 10^{-5} \text{ units of } (1/\text{k}\Omega)$$

To compute the typical input current thresholds from the mean input current, it is necessary to obtain the hysteresis. The following equation finds the hysteresis given the mean threshold current, I:

$$H = H_0 + k \times I \quad (I < 0)$$

where H₀ = -0.033463 in mA, and k = -0.08414 in mA/mA.

Input current threshold high = I - H/2, input current threshold low = I + H/2.

Application Information

Use of Digital and Analog Outputs

The digital output can be used to provide the μP with an interrupt signal that can represent a Hall sensor change of status. DOUT1 and DOUT2 provide a time domain output filter for robust noise immunity. See Figure 2. The analog output can be connected to an ADC with an appropriate load resistor, and can be used to perform custom diagnostics.

Dual, 2-Wire Hall-Effect Sensor Interface with Analog and Digital Outputs

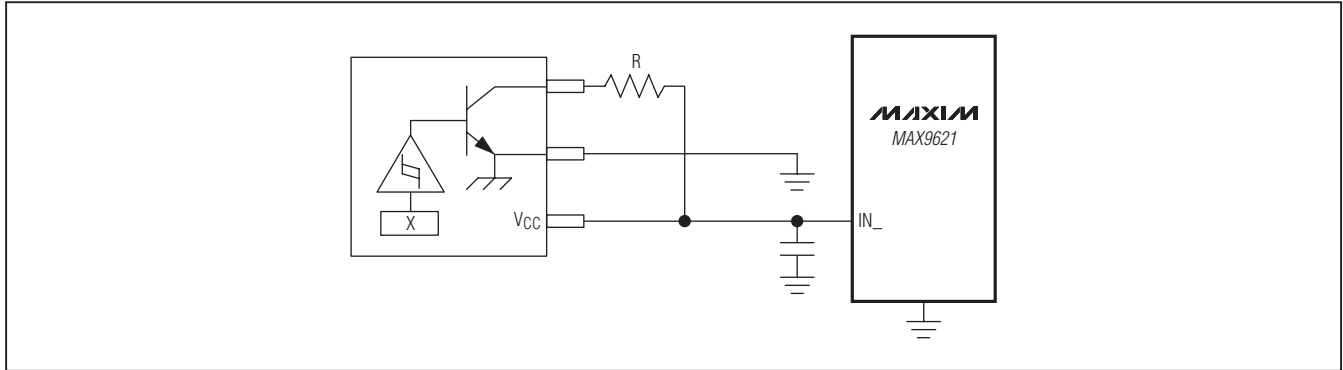

Figure 5. 3-Wire Hall-Effect Switches Configured as 2-Wire

Table 2. A Partial List of Compatible Hall Switches

PART NO.	MANUFACTURER	WEBSITE	COMMENTS
HAL573-6	Micronas	www.micronas.com	2-wire
HAL556/560/566	Micronas	www.micronas.com	2-wire
HAL579/581/584	Micronas	www.micronas.com	2-wire
A1140/1/2/3	Allegro	www.allegromicro.com	2-wire
A3161	Allegro	www.allegromicro.com	3-wire, optimized for 2-wire use without added resistor
TLE4941/C	Infineon	www.infineon.com	2-wire

Sleep Mode

Sleep mode can be used in applications that do not continuously require the polling of the Hall sensors. In such cases, the μ P can enable the MAX9621 for a short time, check the sensor status, and then put the MAX9621 back to sleep. A blanking period follows upon exiting sleep mode.

Remote Ground

The MAX9621 targets applications with 2-wire Hall-effect sensors. 2-wire sensors have connections for supply and ground. The output level is signaled by means of modulation of the current drawn by the Hall sensor from its supply. The two threshold currents for high/low are generally in the range of 5mA to 14mA. Thus, the interfacing of a 2-wire sensor is not simply a matter of detecting two voltage thresholds, but requires a coarse current-sense function.

Because of the high-side current-sense structure of the MAX9621, the device is immune to shifts between the

sensor ground, the ground of the MAX9621 and μ P. This ground-shift immunity eliminates the need for a ground-connection wire, allowing a single-wire interface to the Hall sensor.

Hall-Effect Sensor Selection

The MAX9621 is optimized for use with 2-wire Hall-effect switches or with 3-wire Hall-effect switches connected as 2-wire (Figure 5). When using a 3-wire Hall sensor the resistor R is chosen so that the current drawn by the Hall sensor crosses the MAX9621 current threshold when the magnetic threshold of the Hall sensor is exceeded. A partial list of Hall switches that can be used with the MAX9621 is given in Table 2.

Input Current Threshold Precision

To get the best input current threshold precision, it is recommended that the R_{SET} resistor be directly connected to the BAT pin. A true Kelvin type connection is best.

Dual, 2-Wire Hall-Effect Sensor Interface with Analog and Digital Outputs

Typical Application Circuit

MAX9621

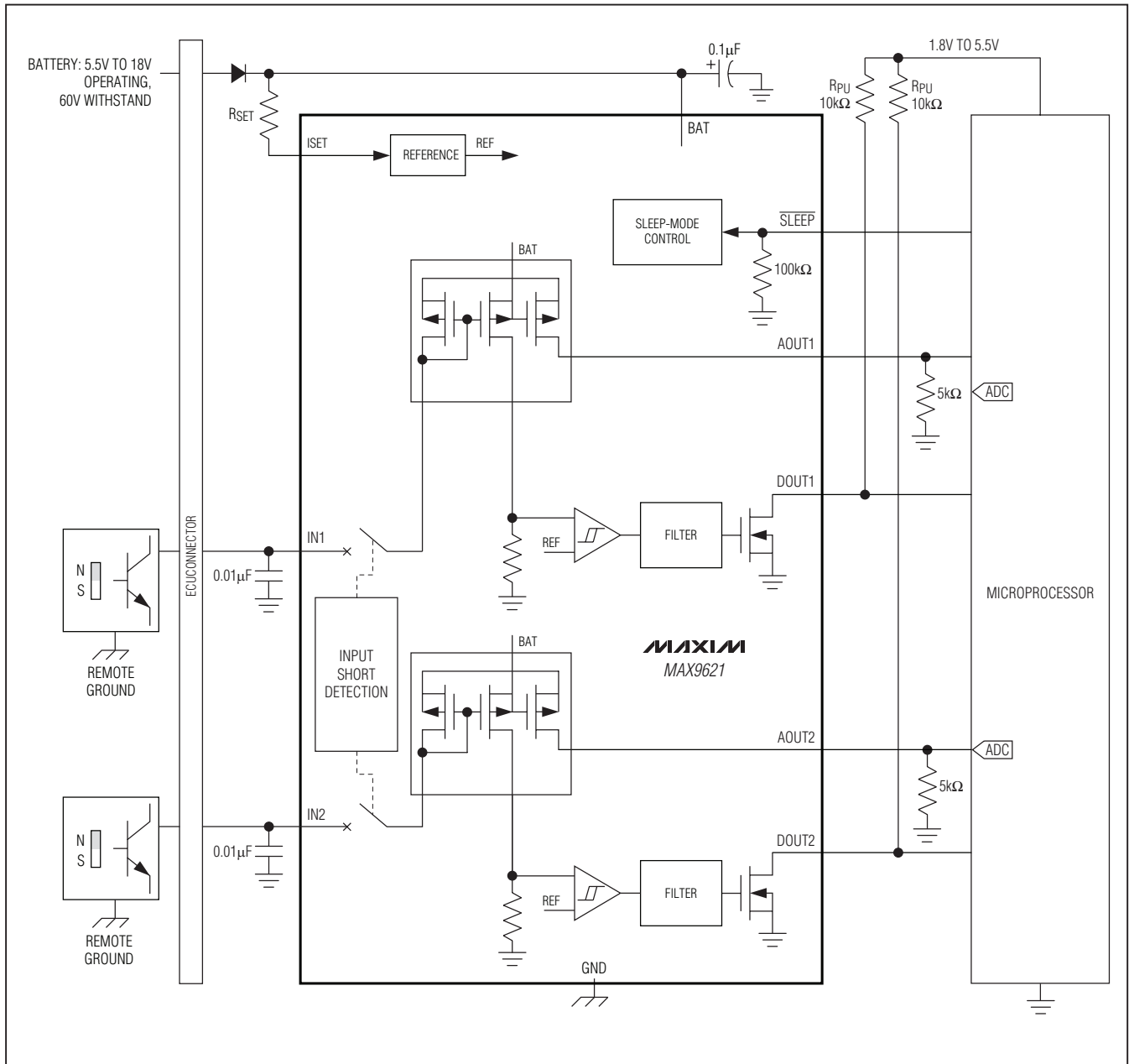

Chip Information

PROCESS: BiCMOS

Dual, 2-Wire Hall-Effect Sensor Interface with Analog and Digital Outputs

Package Information

For the latest package outline information and land patterns (footprints), go to www.maxim-ic.com/packages. Note that a "+", "#", or "-" in the package code indicates RoHS status only. Package drawings may show a different suffix character, but the drawing pertains to the package regardless of RoHS status.

PACKAGE TYPE	PACKAGE CODE	OUTLINE NO.	LAND PATTERN NO.
10 μ MAX	U10+2	21-0061	90-0330

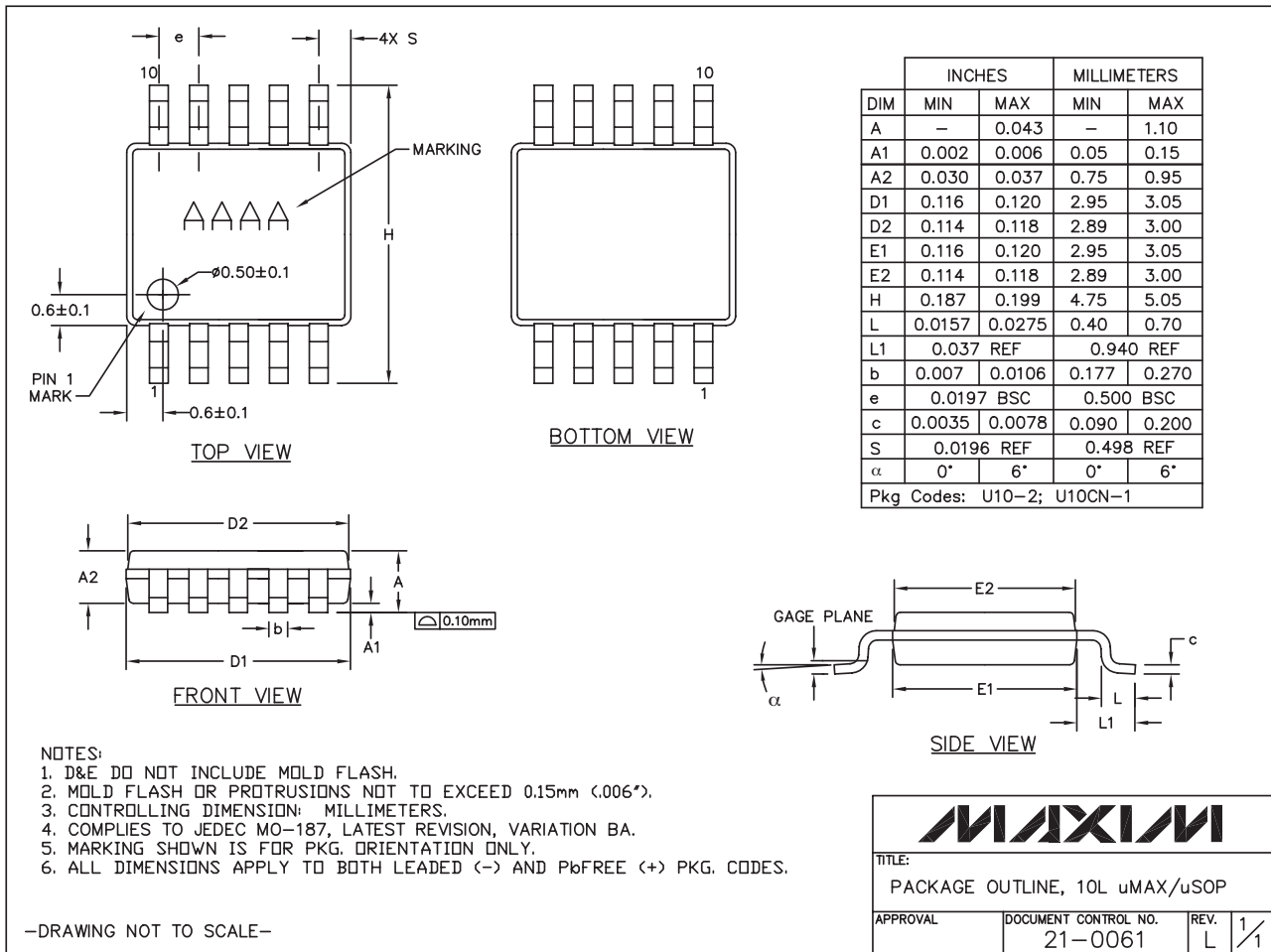

10LUMAX.EPS

Dual, 2-Wire Hall-Effect Sensor Interface with Analog and Digital Outputs

Revision History

REVISION NUMBER	REVISION DATE	DESCRIPTION	PAGES CHANGED
0	11/09	Initial release	—
1	9/11	Added automotive qualified part	1

MAX9621

Maxim cannot assume responsibility for use of any circuitry other than circuitry entirely embodied in a Maxim product. No circuit patent licenses are implied. Maxim reserves the right to change the circuitry and specifications without notice at any time.

Maxim Integrated Products, 120 San Gabriel Drive, Sunnyvale, CA 94086 408-737-7600 _____ **15**