

GEMINI 4100/4200 - 6-DIGIT PRESETTABLE COUNTER/RATE OR DUAL COUNTER INDICATORS GEMINI 4100 - SINGLE LEVEL & GEMINI 4200 - DUAL LEVEL



- 6-DIGIT, 0.56" (14.2 mm) HIGH LED DISPLAY WITH NEGATIVE SIGN OVERFLOW & DISPLAYED VALUE INDICATORS
- TWO DISPLAY CHANNELS: A[rate or count], B[count]
- SEPARATE INPUT SCALING FOR BOTH CHANNELS



- ACCEPTS COUNT RATES TO 10 KHz
- BI-DIRECTIONAL COUNTING, UP/DN CONTROL
- QUADRATURE SENSING (Up to 4 times resolution)
- SOLID-STATE CURRENT SINK OUTPUT(S)
- OUTPUT(S) ASSIGNABLE TO EITHER CHANNEL
- OPTIONAL 20 mA CURRENT LOOP FOR SERIAL DATA COMMUNICATION
- RELAY OUTPUT(S) (Field Replaceable)
- PROGRAMMABLE TIMED OUTPUT(S) (0.01 to 599.99 sec.)
- ABILITY TO LOCK OUT FRONT PANEL FUNCTIONS
- SEALED FRONT PANEL CONSTRUCTION (NEMA 4/IP65)
- NON-VOLATILE MEMORY (E²PROM)
- PROGRAMMABILITY OF DECIMAL POINT LOCATION & LEADING ZERO BLANKING

DESCRIPTION

The Gemini 4100 and 4200 offer the features of a single (4100) or dual (4200) level, dual function Counter and Rate instrument or Dual Counter instrument in one economically priced package. The Gemini 4000 Series is ideally suited for applications where rate and count indication or control of a process is desired or where batching and totalizing is needed.

The reliability of solid-state MOS technology coupled with the flexibility of user programmability makes these units suited to handle practically any preset control application.

There are two signal inputs to which the count or count control signals for both channels are applied. The Gemini can operate under any one of six input response modes: Count with Inhibit, Count with Up/Dn Control, Anti-Coincidence Add/Subtract, Separate Input mode, or Quadrature modes. As a Counter/Rate instrument, the rate indicator will utilize the same count signal input as the counter except when in "Separate Input" mode, where the rate channel will use one input and the counter channel the other. As a dual counter instrument, both counters will utilize the signal inputs in the same manner. In other words, in all modes except the "Separate Input" mode, a count pulse applied to the input will affect both counters in the same manner.

The choice of several reset cycle modes along with the compatibility of count and control inputs to other RLC products, provides added versatility for both stand-alone and system counter needs.

The Rate Indicator portion uses a time interval method (1/tau) to calculate the rate value. This method enables high resolution at all input rates. The unit counts input pulses and after a programmable minimum update time has occurred, it waits until the next count edge occurs, then takes the elapsed time and number of edges and calculates the rate value.

At slower rates, averaging can be accomplished by programming the "Rate Minimum Update Time" (0.5 sec. to 16 sec.) for the desired response. The minimum input frequency is 0.03 counts/sec. or one pulse every 32 seconds. Extensive scaling capabilities allow practically any desired reading at very slow input rates.

The output(s) can be assigned to either the Rate or Count channel, or one output to each. When programmed as a Dual Counter, both outputs can be assigned to Counter B or Output 1 to Counter A and Output 2 to Counter B.

The 20 mA Current Loop Communications Option provides the capability of two-way serial communications between the Gemini and a variety of equipment, such as a printer, remote terminal, programmable controller, or host computer. The baud rate can be set to 300, 600, 1200, or 2400 baud. The format for transmitted and received data is 1 start bit, 7 data bits, 1 parity bit (odd) and 1 stop bit. When utilizing an external power supply (30 VDC max), up to sixteen units can be installed in the loop, each with an individual address. When utilizing the Gemini's 20 mA current source, up to seven units can be installed in a loop. The Preset and Scale Factor can be changed by sending the proper command codes and numerical data to the unit. Other functions, such as resetting the various counters, can also be performed. Various "Print Options" can be selected to automatically interrogate the Count Values, Presets, and Scale Factor by activating the "Print Request" terminal or by sending a "Transmit Per Print Option" (P) command.

The construction of the Gemini 4000 Series features a metal die-cast bezel offering maximum durability with a high quality appearance. The sealed front panel meets NEMA 4/IP65 specifications for wash-down and/or dust when properly installed. Electrical connections are made via plug-in terminal strips. Clamp-type pressure plate terminals accept stripped #14 AWG wire without lugs.

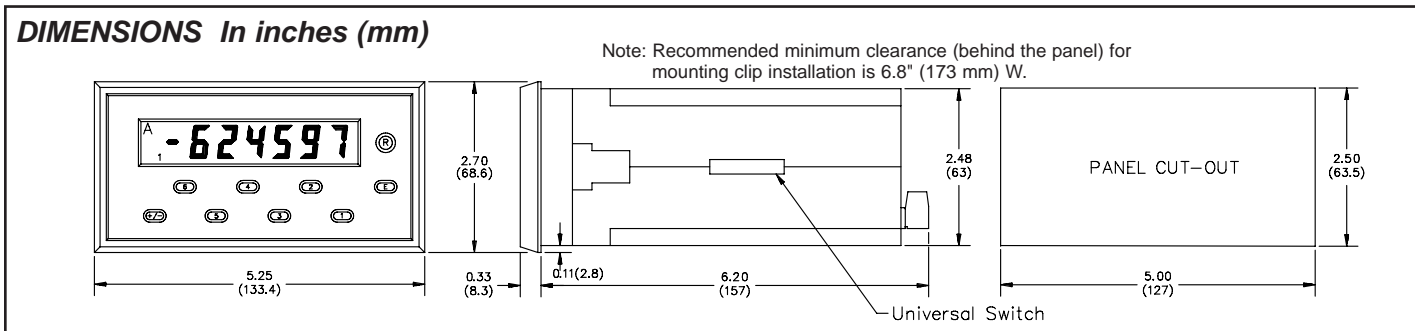

SPECIFICATIONS

1. **DISPLAY:** 6-Digit 0.56" (14.2 mm) High LED display

2. POWER REQUIREMENTS:

AC Versions:

AC Power: Switch selectable 115/230 VAC, ($\pm 10\%$), 50/60 Hz, 20 VA.

DC Power: 11 to 14 VDC @ 0.7 amp max.

3. **SENSOR POWER:** +12 VDC ($\pm 25\%$) @ 100 mA.

Note: The sensor supply voltage varies $\pm 25\%$ due to line and internal load variations. All RLC sensors will accommodate this variation.

4. **MEMORY:** Non-volatile E²PROM memory retains all programming information and count values (*except Counter Load Values*) when power is removed or interrupted.

Power Cycles: 100,000 min.

Data Retention: 10 years min.

5. **INPUTS 1 AND 2:** Switch selectable to accept count pulses from a variety of sources including switch contacts, outputs from CMOS or TTL circuits, and all standard RLC sensors.

Current Sourcing: Unit provides 3.9 K Ω pull-down resistor for sensors with current sourcing outputs. Max. input voltage = 28 VDC @ 7 mA.

Current Sinking: Unit provides 7.8 K Ω pull-up resistor for sensors with current sinking outputs. Max. sensor current = 1.6 mA.

Debounce: Damping capacitor provides for switch contact debounce. Limits count speed to 100 Hz max. with 50% duty cycle.

Lo Bias: Input trigger levels $V_{IL} = 1.5$ V, $V_{IH} = 3.75$ V.

Hi Bias: Input trigger levels $V_{IL} = 5.5$ V, $V_{IH} = 7.5$ V.

Note: Bias levels given are $\pm 10\%$ @ 12 VDC. These levels vary proportionally with sensor supply voltage at "DC OUT" terminal.

6. MAGNETIC PICKUP INPUT:

Sensitivity: 150 mV peak (typical @ 12 VDC)

Hysteresis: 100 mV

Input Impedance: 26.5 K Ω @ 60 Hz

Maximum Input Voltage: ± 50 V peak

7. **RATE ACCURACY AND REPEATABILITY:** 0.012%

8. **RATE MINIMUM INPUT FREQUENCY:** 0.03 Hz

Note: At frequencies below 0.03 Hz (1 pulse every 32 sec.) the rate display will go to zero.

9. MAXIMUM COUNT RATES:

COUNTER/RATE MODE [41 1]			
MODE	X1	X2	X4
Uni or Bi-directional	10 KHz	5 KHz	
Anti-Coincidence Add/Subtract	4 KHz	2.5 KHz	
Separate Input	8 KHz	4 KHz	
Quadrature	5 KHz	4.5 KHz	2.5 KHz
DUAL COUNTER MODE [41 2]			
MODE	X1	X2	X4
Uni or Bi-directional	9 KHz	4.5 KHz	
Anti-Coincidence Add/Subtract	5 KHz	2.5 KHz	
Separate Input	7.5 KHz	3.5 KHz	
Quadrature	4.5 KHz	4 KHz	2.5 KHz

10. CONTROL INPUTS:

Reset: Active low ($V_{IL} = 1.5$ V max.) internally pulled up to +12 VDC ($I_{SNK} = 3$ mA), activation and de-activation response time = 10 msec.

Program Disable: Active low ($V_{IL} = 1.5$ V max.) internally pulled up to +5 VDC ($I_{SNK} = 1$ mA).

Print Request: Active low ($V_{IL} = 1.5$ V max.) internally pulled up to +5 VDC ($I_{SNK} = 1$ mA).

11. SERIAL COMMUNICATIONS (Optional):

Type: Bi-directional 20 mA current loop, 20 mA source provided. (*Powers up to 7 units in a loop with internal current source.*)

Baud Rate: Programmable 300 to 2400

Maximum Address: 16 units. (*Actual number in a single loop is limited by serial hardware specifications.*)

Data Format: 10 bit frame, Odd parity (*one start bit, 7 data bits, one odd parity bit, and one stop bit.*)

Serial Hardware Specifications:

SO - Output Transistor Rating: $V_{MAX} = 30$ VDC, $V_{SAT} = 1V_{MAX}$ @ 20 mA.

SI - Input Diode Rating: $V_F = 1.25$ V_{TYP}; 1.5 V_{MAX}.

Note: The compliance voltage rating of the source must be greater than the sum of the voltage drops around the loop.

12. OUTPUT(S):

Solid-State: Current sinking NPN Open Collector Transistor(s). $I_{SNK} = 100$ mA max. @ $V_{CE} = 1$ V. $V_{OH} = 30$ VDC max. (Internal Zener Diode Protection).

Relays: Mounted on a field-replaceable PC board. Form C contacts rated at 5 amps @ 120/240 VAC, 28 VDC (resistive load), 1/8 H.P. @ 120 VAC (inductive load). The operate time is 5 msec nominal and the release time is 3 msec nominal.

Relay Life Expectancy: 100,000 cycles @ max. rating. (*As load level decreases, life expectancy increases.*)

Programmed Timed Output: The timed output can be set from 0.01 to 599.99 seconds, $\pm(0.01\% + 10$ msec)

13. CERTIFICATIONS AND COMPLIANCES:

SAFETY:

IEC 1010-1, EN 61010-1: Safety requirements for electrical equipment for measurement, control, and laboratory use, Part 1.

IP65 Enclosure rating (Face only), IEC 529

Type 4 Enclosure rating (Face only), UL50

ELECTROMAGNETIC COMPATIBILITY

Immunity to EN 50082-2

Electrostatic discharge	EN 61000-4-2	Level 2; 4 Kv contact ¹ Level 3; 8 Kv air
Electromagnetic RF fields	EN 61000-4-3	Level 3; 10 V/m 80 MHz - 1 GHz
Fast transients (burst)	EN 61000-4-4	Level 4; 2 Kv I/O Level 3; 2 Kv power ²
RF conducted interference	EN 61000-4-6	Level 3; 10 V/rms 150 KHz - 80 MHz
Power frequency magnetic fields	EN 61000-4-8	Level 4; 30 A/m
Emissions to EN 50081-2		
RF interference	EN 55011	Enclosure class A Power mains class A

Notes:

1. Metal bezel of unit connected with ground from rear bezel screw to metal mounting panel.

2. When the unit is DC powered, a power line filter (RLC# FLFI0000 or equivalent) was installed, so as not to impair the function of the unit.

Refer to the EMC Compliance Installation section of the manual for additional information.

14. ENVIRONMENTAL CONDITIONS:

Operating Temperature: 0 to 50°C

Storage Temperature: -40 to 70°C

Operating and Storage Humidity: 85% max. relative humidity (non-condensing) from 0°C to 50°C.

Altitude: Up to 2000 meters

15. CONSTRUCTION:

Metal die-cast bezel, plastic case. This unit is rated for NEMA 4/IP65 indoor use. Installation Category II, Pollution Degree 2

16. **WEIGHT:** 2.1 lbs. (0.9 kg)

PROGRAMMABLE FUNCTIONS

UNIT PERSONALITY

Functions as a Counter and Rate Indicator or as two counters.

PRESET(S)

Range 0 to ±999999

SCALE FACTORS

Separate 5-digit input scaling for each channel. Range ±0.0001 to 5.9999.

SCALE MULTIPLIER

Multiplies the actual count or rate input by 1, 0.1, 0.01, or 0.001 (counter) or 1000, 100, 10, 1, 0.1, 0.01 (rate), to view the desired number of significant digits on the 6-digit display.

INPUTS 1 & 2 RESPONSE MODES

- Count (1) with Inhibit (2)
- Count (1) with Up/Down Control (2)
- 2-Input Anti-Coincidence Add (1)/Subtract (2)
- Separate Inputs
- Quadrature
- Quadrature X4

NUMBER OF COUNT EDGES

Register counts on one or both edges of input signal (counter only).

RESET ACTION

Reset-to-Zero; Output activates when count equals the preset value. Counter returns to zero when reset.

Reset-to-Preset; Output activates when count equals zero. Counter returns to preset when reset.

RESET MODES

- Manual Reset
- Automatic Reset at Preset or Zero
- Automatic Reset after Timed Output

Manual reset via front panel pushbutton or remote "RST." terminal can be programmed to act on one or both count channels with either momentary or maintained action. A separate "RST. A" terminal is available to provide independent reset of each channel. Front panel pushbutton reset may be disabled by a switch at the rear of the unit.

COUNTER LOAD

Allows counter value(s) to be changed via the front panel.

RATE RIGHT-HAND DUMMY ZEROS

Up to three non-functional zeros may be placed on the least significant end of the display.

RATE UPDATE TIME

"Rate Minimum Update Time" is programmable from 0.5 to 16 seconds which allows averaging capability for non-consistent pulse spacing. Rate maximum update time will vary with the minimum update time selected.

RATE CONVERSION FACTOR

Provides easy display conversion for readout in Rate Per Second, Rate Per Minute, or Rate Per Hour.

DECIMAL POINT & LEADING ZERO BLANKING

Decimal point programmable to desired location. Leading zero blanking, when selected, begins with second digit to the left of the decimal point.

OUTPUT TERMINATION MODES

- Terminate at "other" Output Start (Gemini 4200 only)
- Terminate at "other" Output End (Gemini 4200 only)
- Terminate at Manual Reset
- Terminate at Manual Reset End
- Terminate after Time Delay
- Boundary
- For positive preset value: Output terminates when Display is less than Preset.
- For negative preset value: Output terminates when Display is greater than Preset, (i.e. more positive). Negative preset values apply only to counter mode.

Note: In any of the above modes, the unit may be programmed for "Reverse Phase" operation which complements the logic state of the output.

TIMED OUTPUT(S)

- Programmable from 0.01 to 599.99 seconds.
- Accurate to ±(0.01% + 10 msec.).

FRONT PANEL LOCKOUT MODES

When the "Program Disable" control input is activated, the ability to change front panel programmed functions will be prevented as per the following modes:

- Complete Front Panel Disabled
- Preset(s) Enabled Only
- Scale Factors Enabled Only
- Preset(s) and Scale Factors Enabled
- Preset(s) and Counter Load Enabled
- Preset(s), Scale Factors, and Counter Load Enabled

Note: Manual Reset may be independently enabled or disabled in any of the above modes.

SELF-TEST

Performs a complete check on the display and output circuitry along with a functional check on the CPU. Self-test is non-destructive and may be performed during a process without losing counts.

PROGRAMMING

The Gemini 4000 Series input circuit set-up is programmed using DIP switches on the rear of the unit. All other functions are programmed through the front panel pushbuttons.

To program or interrogate a function, the user first enters a two-digit function code. The unit will then display that function code along with a single-digit mode identifier.

EXAMPLE: The function code representing the "Inputs 1 & 2 Response Modes" is 43. The mode identifiers for this function are:

1. Count with Inhibit
2. Count with Up/Down Control
3. 2-Input Anti-Coincidence Add/Subtract
4. Separate Inputs
5. Quadrature
6. Quadrature X4

To interrogate the counting modes,

Press "4", then "3":

Unit displays the function code along with mode identifier 1 (Count with Inhibit)

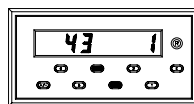

To change the counting mode to "Count with Up/Dn control", Press "2":

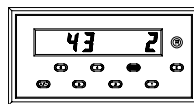

To enter and save the new mode, Press "E":

Unit enters new mode and returns display to the present selected display value.

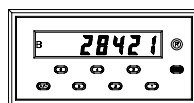

The most commonly used functions, Preset(s) and Scale Factors, are initialized through single front panel pushbuttons rather than a two-digit function code. Pressing the "1" or "3" pushbuttons will immediately display the current Preset or Scale Factor value for the selected display. To change any digit, the user presses the pushbutton directly below that particular digit, which is then scrolled until the desired value is obtained. Each digit is changed, if necessary, in the same manner until the complete Preset or Scale Factor value is registered on the display. Pressing the "E" pushbutton completes the entry sequence.

To interrogate the Preset value, Press "1":

Unit displays current Preset value.

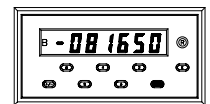

To change the Preset value:

Any digit may be changed by pressing the pushbutton directly below it. Release the pushbutton when the digit reaches the desired value.

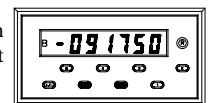

Press "E":

Unit enters new Preset value and returns display to the present selected display value.

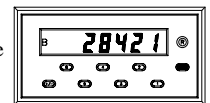

The Gemini 4000 Series can display either of two selected display values as indicated by LEDs along the left side of the display.

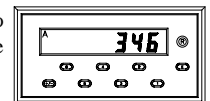

To display a different count value:

Press the "+/-" pushbutton repeatedly until the indicator corresponding to the desired value turns on.

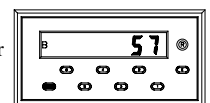

TYPICAL COUNTER/RATE APPLICATION

COAL FEED RATE & USAGE INDICATION

An industrial plant has an in-house coal fired boiler which provides heating and powers an electric generator used for secondary power. An auger feeds the coal into the boiler furnace. The actual pressure of the boiler is controlled by the feed rate of the auger. An indication is required when the feed rate falls below or exceeds the desired RPM levels. The plant manager also wants an indication of the amount of coal that is used. The normal desired auger revolution rate is between 30 and 40 RPM. A shaft rotation speed of 30 RPM is equal to a feed rate of 1.8 tons of coal per hour. Rate and usage indication is to be in 10ths of tons per hour.

Since the application requires two presets (upper and lower limits) the Gemini 4200 programmed as a Counter/Rate indicator is used. An LMPC can be used to sense a bolt head located on the auger shaft. Both outputs of the Gemini 4200 are assigned to the Rate channel. First the scaling required for the counter will be calculated. At 30 RPM the pulse rate per minute is the same since a single bolthead is being sensed once each revolution. Since it takes one hour at 30 RPM to use 1.8 tons of coal, the number of pulses accumulated in that hour will be 1800 (30 PPM x 60 min/hr = 1800). The Scale Factor needed is 0.01 (SF = desired reading/# of pulses = 18/1800 = 0.01). Since the same information rate and desired reading applies to the rate indication, the same Scale Factor value will be used. It is then only necessary to program the Rate Conversion Factor for Rate per Hour. Both Presets are programmed for boundary operation and the Relay outputs are connected to overspeed and underspeed indicator lights.

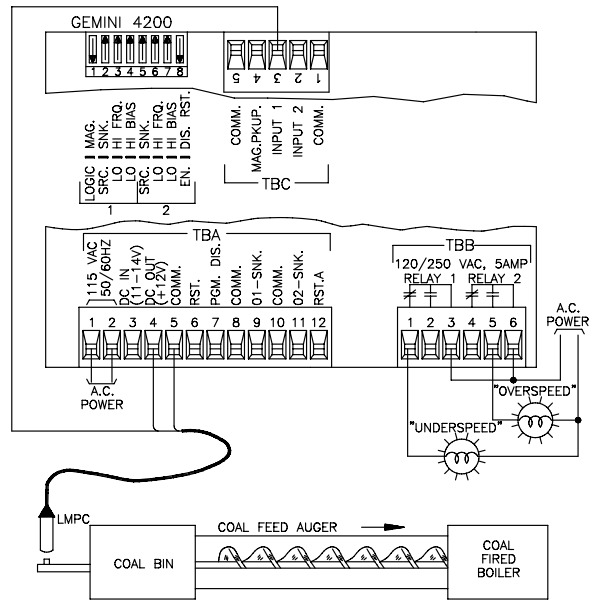

TYPICAL DUAL COUNTER APPLICATION

PERCENTAGE OF USABLE PARTS VERSUS PARTS PRODUCED

A manufacturer of molded plastic parts wants to track the percentage of usable parts versus parts produced to determine if a defect has developed in the mold or some other malfunction is occurring which requires corrective action.

From the molding press, parts pass through an inspection station and exit on one of two conveyors depending on whether the part is accepted or rejected. A Gemini 4100 programmed as a dual counter is used in the separate inputs mode. Count Channel B tabulates the number of acceptable parts via a photo sensor mounted on the conveyor. Likewise, count Channel A tabulates the

number of rejected parts from a second photo sensor. A system computer constantly monitors the two count values through the Gemini Serial Communications Loop and performs the percentage calculation required.

The single preset output of the Gemini 4100 is assigned to count Channel B and is set for the number of acceptable pieces required to fill the order. The preset value could be entered by the operator through the front panel pushbuttons or could be entered into the system computer and down loaded to the Gemini.

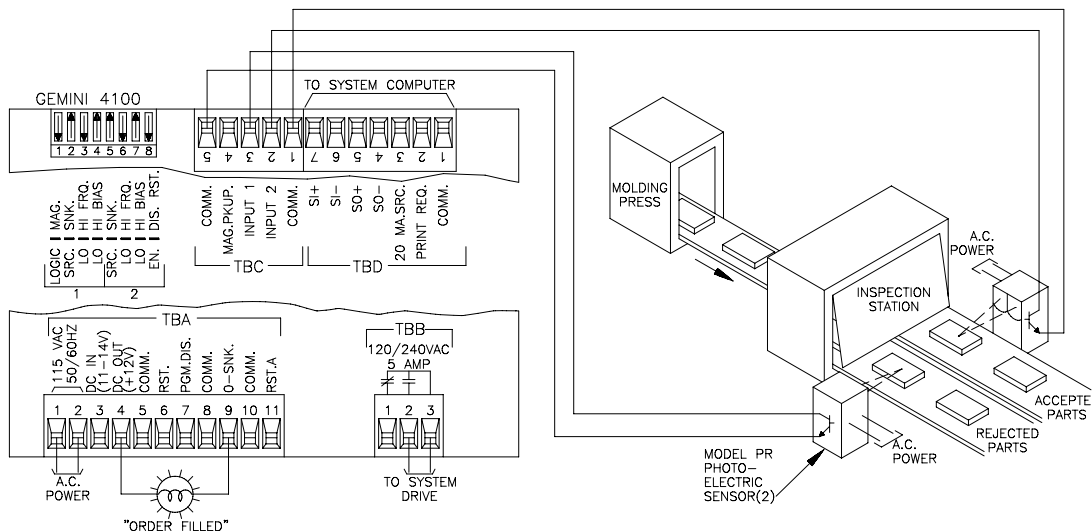

ORDERING INFORMATION

MODEL NO.	DESCRIPTION	w/20 mA CURRENT LOOP	PART NUMBERS
			115/230 VAC
GEM41	Gemini 4100	No	GEM41060
		Yes	GEM41160
GEM42	Gemini 4200	No	GEM42060
		Yes	GEM42160
-	Gemini 4100 Relay Board	N/A	RLYBD001
-	Gemini 4200 Relay Board	N/A	RLYBD002

For more information on Pricing, Enclosures, & Panel Mount Kits, refer to the RLC Catalog or contact your local RLC distributor.

GEMINI 4100 DUAL COUNTER PROGRAMMING CHART

FEATURE & MODE SELECTION (See Programming Procedure)

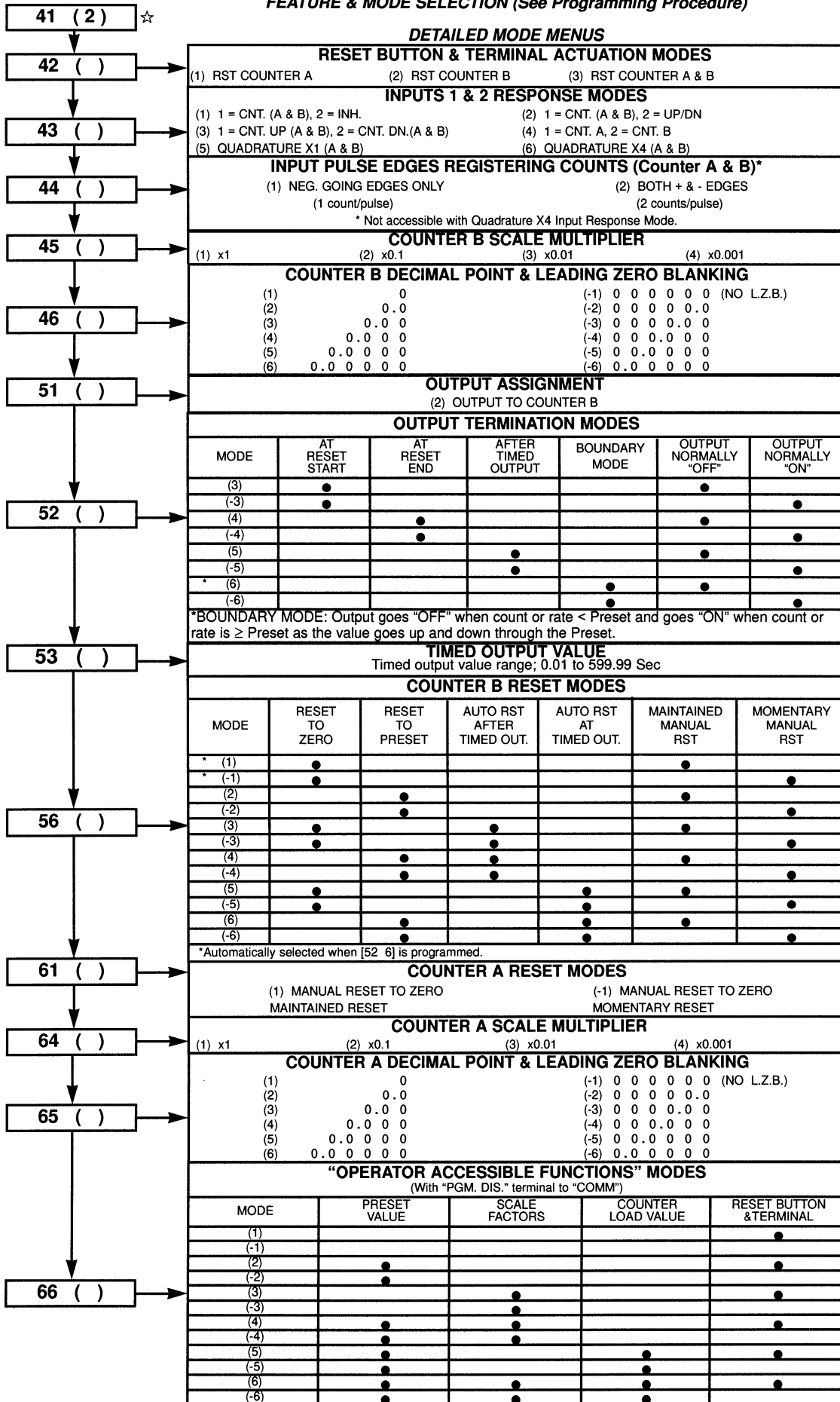

☆ Entering a [41 -2], at any time will load factory settings for all modes.

GEMINI 4100 PROGRAMMING

SOME NOTES & HINTS ON PROGRAMMING THE GEMINI 4100

1. Be systematic about programming! Plan out the exact features & functions you need for your application. Write out the code entries you need from start to finish, and then enter the codes completely. Don't start in the middle of the program codes & make arbitrary entries to "see what it will do." This is a sure way to create confusing results. Finally, after you are done, record your program & file it where you can find it later if you want to make changes. You can use this card to write in your codes in the program ladder on the reverse side, together with any fixed data entries, for convenient future reference.

2. Watch out for conflicting modes! The programs in the GEMINI 4100 have been written to prevent illegal code entry.

However, to provide optimum flexibility, some reliance must be placed on the programmer to avoid conflicting codes.

3. The GEMINI 4100 can be interrogated at any time to see what modes & data entries have been made. Such interrogation can be made during a counting cycle or a sample time run without interrupting the normal counting process. In the lockout mode, all functions can also be interrogated, but those functions locked out cannot be changed. Making changes in program modes or data during a run is not recommended since mid-cycle changes can result in unanticipated outputs for that particular cycle.

PROGRAMMING PROCEDURE FOR FUNCTION & MODE SELECTION ☆ (Applies To Programming Chart)

To enter a programmable function or mode, enter the function selector code desired and then select the particular mode identifier required.

For example, to set up a decimal point to display a reading in 1/100ths with leading zero blanking, function selector code #46 must be entered. (See codes on reverse side.)

Press button #4, then button #6. The display will temporarily interrupt its normal readout (without interfering with the normal operation of the unit).

It will then display the entered code on the L.H. side.

[46] (DISPLAY READOUT)

Next, enter the mode identifier (button #3) that defines the decimal point location & LZB condition. This code is displayed on the right.

[46 3] (DISPLAY READOUT)

Now, enter this new selection by pressing the "E" button.

PROGRAMMING PROCEDURE FOR DATA ENTRY

In data entry, the front panel pushbuttons are identified by two different sets of references and will cause two different reactions in the course of making a data entry.

In the first phase of a data entry cycle, the particular data entry mode is called up by pushing the buttons identified by their panel markings. (i.e. Buttons "5", "3", or "1"). Once the data entry mode has been entered, the existing data appears on the display and the buttons below the display reference themselves to the digits directly above each button. The data can then be changed a digit at a time by depressing the button directly below the digits to be changed.

After the new data value is obtained, the "E" button is depressed to enter the new value.

[53] TIMED OUTPUT VALUE ☆

Entering Code "53" will call up the Timed Output Value in seconds & hundredths. The value can be set to the new value by incrementing each digit with the button underneath that digit.

Press the "E" button to enter the new Timed Output value. (Max. Timed Output value = 599.99 sec.)

[3] SCALE FACTOR

One stroke of the "3" button calls up the existing Scale Factor for the currently displayed count or rate value. (The Scale Factor is the multiplier used to convert the actual count or rate to the direct readout display). The value can be changed by incrementing each digit with the button below it. Pressing the "E" key enters the new S.F. The S.F. can be set at any value from +/- 0.0001 to +/-5.9999. (Positive only for Rate Scale Factor A.)

[1] PRESET

One stroke of the "1" button calls up the preset value, which can then be changed by incrementing each digit with the button below it. Press the "E" button to enter the new Preset.

☆ Program before connecting "PGM. DIS." to "COMMON".

SELF TEST ROUTINE 6, +/-

Depressing "6" & then "+/-" starts the self test routine by lighting all decimal points, then all 9's, all 8's, all 7's etc., until alternate 8's & 9's are displayed. At this time, the output can be manually activated for testing by pressing the "1" button. (The Output test is

disabled when "PGM. DIS." terminal is pulled to "COMMON".) An automatic exit will occur six (6) seconds after the Test Mode is completed. Test Mode can be run at any time and will not interfere with the normal operation of the Gemini 4100.

GEMINI 4200 COUNTER/RATE PROGRAMMING CHART

FEATURE & MODE SELECTION (See Programming Procedure)

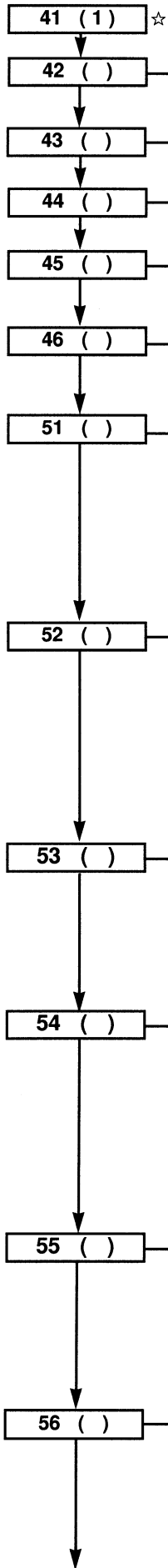

DETAILED MODE MENUS									
RESET BUTTON & TERMINAL ACTUATION MODES									
(1) RST RATE OUTPUT			(2) RST COUNTER			(3) RST RATE OUTPUT & COUNTER			
INPUTS 1 & 2 RESPONSE MODES									
(1) 1 = CNT. & RATE, 2 = INH. (CNT.)					(2) 1 = CNT. & RATE, 2 = UP/DN				
(3) 1 = CNT. UP & RATE, 2 = CNT. DN.					(4) 1 = RATE, 2 = CNT.				
(5) QUADRATURE X1 (1 = RATE)					(6) QUADRATURE X4 (1 = RATE)				
INPUT PULSE EDGES REGISTERING COUNTS (Counter B)*									
(1) NEG. GOING EDGES ONLY (1 count/pulse)					(2) BOTH + & - EDGES (2 counts/pulse)				
* Not accessible with Quadrature X4 Input Response Mode.									
COUNTER SCALE MULTIPLIER									
(1) x1		(2) x0.1		(3) x0.01		(4) x0.001			
COUNTER DECIMAL POINT & LEADING ZERO BLANKING									
(1) 0		(2) 0.0		(3) 0.00		(4) 0.000			
(5) 0.0000		(6) 0.00000		(-1) 0 0 0 0 0 0 (NO L.Z.B.)		(-2) 0 0 0 0 0.0			
						(-3) 0 0 0 0.0 0			
						(-4) 0 0 0.0 0 0			
						(-5) 0 0.0 0 0 0			
						(-6) 0 0 0 0 0 0			
OUTPUT ASSIGNMENT*									
(±1) OUT 1→RATE, OUT 2→CNTR			(±2) OUT 1 & 2→CNTR			(±3) OUT 1 & 2→RATE			
* A (-) preceding the mode identifier enables Preset 1 to track Preset 2.									
OUTPUT 1 TERMINATION MODES									
MODE	AT OUTPUT 2 START	AT OUTPUT 2 END	AT RESET START	AT RESET END	AFTER TIMED OUTPUT 1	BOUNDARY MODE	OUTPUT 1 NORMALLY "OFF"	OUTPUT 1 NORMALLY "ON"	
† (1)	●						●		
† (-1)	●							●	
† (2)		●					●		
† (-2)		●						●	
(3)			●				●		
(-3)			●					●	
(4)				●			●		
(-4)				●				●	
‡ (5)					●		●		
‡ (-5)					●			●	
* (6)						●	●		
* (-6)						●		●	
† These modes are available only when [51 2] is programmed.									
‡ Output 1 activates when Count or Rate ≥ Preset 1 [51 1,2].									
* Output 1 activates when Rate ≤ Preset 1 [51 3].									
* BOUNDARY MODE: Output goes "OFF" when Count or Rate < Preset and goes "ON" when Count or Rate is ≥ Preset as the value goes up and down through the Preset.									
TIMED OUTPUT 1 VALUE									
Timed Output Value range; 0.01 to 599.99 Sec									
OUTPUT 2 TERMINATION MODES									
MODE	AT OUTPUT 1 START	AT OUTPUT 1 END	AT RESET START	AT RESET END	AFTER TIMED OUTPUT 2	BOUNDARY MODE	OUTPUT 2 NORMALLY "OFF"	OUTPUT 2 NORMALLY "ON"	
† (1)	●						●		
† (-1)	●							●	
† (2)		●					●		
† (-2)		●						●	
(3)			●				●		
(-3)			●					●	
(4)				●			●		
(-4)				●				●	
‡ (5)					●		●		
‡ (-5)					●			●	
* (6)						●	●		
* (-6)						●		●	
† These modes are available only when [51 2] is programmed.									
‡ Output 2 activates when Count or Rate ≥ Preset 2.									
* BOUNDARY MODE: Output goes "OFF" when Count or Rate < Preset and goes "ON" when Count or Rate is ≥ Preset as the value goes up and down through the Preset. Automatically selects [56 1] if [51 1 or 2] is programmed.									
TIMED OUTPUT 2 VALUE									
Timed Output Value range; 0.01 to 599.99 Sec									
COUNTER RESET MODES									
MODE	RESET TO ZERO	RESET TO PRESET 2	AUTO RST AFTER TIMED OUT. 2	AUTO RST AT TIMED OUT. 2	MAINTAINED MANUAL RST	MOMENTARY MANUAL RST			
* (1)	●				●				
* (-1)	●					●			
(2)		●			●				
(-2)		●				●			
(3)	●		●		●				
(-3)	●		●			●			
(4)		●	●		●				
(-4)		●	●			●			
(5)	●			●	●				
(-5)	●			●		●			
(6)		●		●	●				
(-6)		●		●		●			
*Automatically selected when [54 6] or [51 3] is programmed.									

61 ()	RATE RIGHT HAND DUMMY ZEROS (1) 0 (2) 00 (3) 000 (4) NONE																																																																	
62 ()	RATE CONVERSION FACTOR (1) RATE/SEC (x1) (2) RATE/MINUTE (x60) (3) RATE/HR. (x3600)																																																																	
63 ()	RATE MINIMUM UPDATE TIME* (1) 0.5 Sec (2) 1 Sec (3) 2 Sec (4) 4 Sec (5) 8 Sec (6) 16 Sec * Maximum update time varies with each minimum update time.																																																																	
64 ()	RATE SCALE MULTIPLIER (1) x1000 (2) x100 (3) x10 (4) x1 (5) x0.1 (6) x0.01																																																																	
65 ()	RATE DECIMAL POINT & LEADING ZERO BLANKING (1) 0 (-1) 0 0 0 0 0 0 (NO L.Z.B.) (2) 0 . 0 (-2) 0 0 0 0 0 . 0 (3) 0 . 0 0 (-3) 0 0 0 0 . 0 0 (4) 0 . 0 0 0 (-4) 0 0 0 . 0 0 0 (5) 0 . 0 0 0 0 (-5) 0 0 . 0 0 0 0 (6) 0 . 0 0 0 0 0 (-6) 0 . 0 0 0 0 0																																																																	
66 ()	"OPERATOR ACCESSIBLE FUNCTIONS" MODES (With "PGM. DIS." terminal to "COMM")																																																																	
	<table border="1"> <thead> <tr> <th>MODE</th> <th>PRESET VALUE</th> <th>SCALE FACTORS</th> <th>COUNTER LOAD VALUE</th> <th>RESET BUTTON & TERMINAL</th> </tr> </thead> <tbody> <tr><td>(1)</td><td></td><td></td><td></td><td>●</td></tr> <tr><td>(-1)</td><td></td><td></td><td></td><td></td></tr> <tr><td>(2)</td><td>●</td><td></td><td></td><td>●</td></tr> <tr><td>(-2)</td><td>●</td><td></td><td></td><td>●</td></tr> <tr><td>(3)</td><td></td><td>●</td><td></td><td>●</td></tr> <tr><td>(-3)</td><td></td><td>●</td><td></td><td></td></tr> <tr><td>(4)</td><td>●</td><td>●</td><td></td><td>●</td></tr> <tr><td>(-4)</td><td>●</td><td>●</td><td></td><td></td></tr> <tr><td>(5)</td><td>●</td><td></td><td>●</td><td>●</td></tr> <tr><td>(-5)</td><td>●</td><td></td><td>●</td><td></td></tr> <tr><td>(6)</td><td>●</td><td>●</td><td>●</td><td>●</td></tr> <tr><td>(-6)</td><td>●</td><td>●</td><td>●</td><td></td></tr> </tbody> </table>	MODE	PRESET VALUE	SCALE FACTORS	COUNTER LOAD VALUE	RESET BUTTON & TERMINAL	(1)				●	(-1)					(2)	●			●	(-2)	●			●	(3)		●		●	(-3)		●			(4)	●	●		●	(-4)	●	●			(5)	●		●	●	(-5)	●		●		(6)	●	●	●	●	(-6)	●	●	●	
MODE	PRESET VALUE	SCALE FACTORS	COUNTER LOAD VALUE	RESET BUTTON & TERMINAL																																																														
(1)				●																																																														
(-1)																																																																		
(2)	●			●																																																														
(-2)	●			●																																																														
(3)		●		●																																																														
(-3)		●																																																																
(4)	●	●		●																																																														
(-4)	●	●																																																																
(5)	●		●	●																																																														
(-5)	●		●																																																															
(6)	●	●	●	●																																																														
(-6)	●	●	●																																																															

☆ Entering a [41 -1], at any time will load factory settings for all modes.

GEMINI 4200 DUAL COUNTER PROGRAMMING CHART

FEATURE & MODE SELECTION (See Programming Procedure)

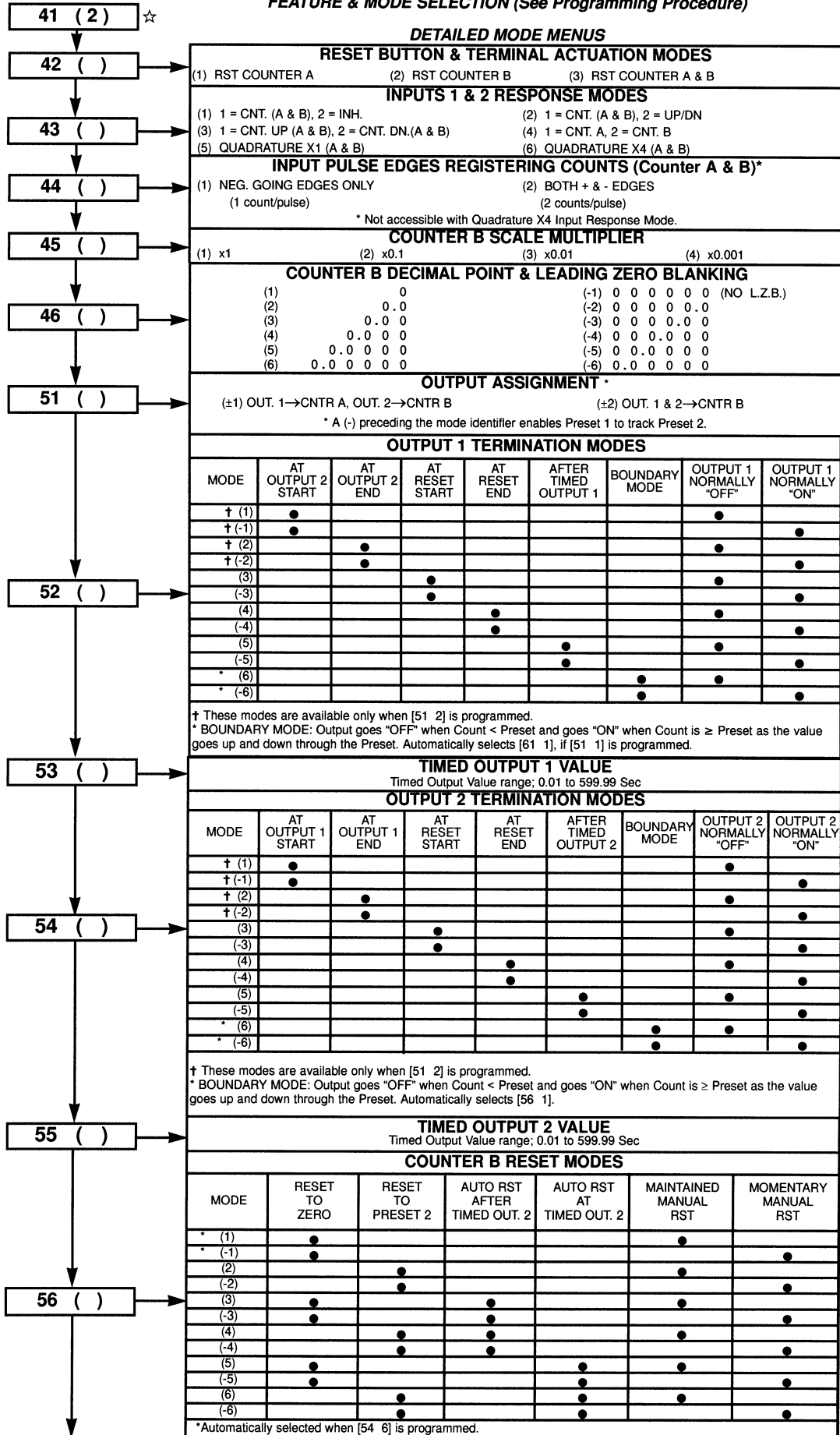

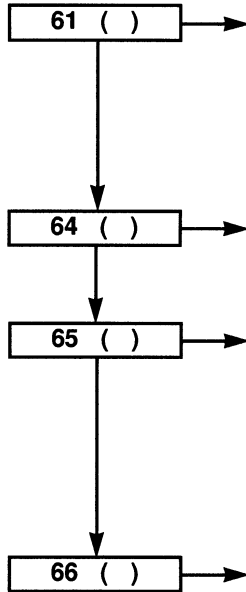

COUNTER A RESET MODES						
MODE	RESET TO ZERO	RESET TO PRESET 1	AUTO RST AFTER TIMED OUT. 1	AUTO RST AT TIMED OUT. 1	MAINTAINED MANUAL RST	MOMENTARY MANUAL RST
* (1)	●				●	
* (-1)	●					●
(2)		●			●	
(-2)		●				●
(3)	●		●		●	
(-3)	●		●			●
(4)		●	●		●	
(-4)		●	●			●
(5)	●			●	●	
(-5)	●			●		●
(6)		●			●	
(-6)		●			●	●

*Automatically selected when [51 2] or [52 6] is programmed.

COUNTER A SCALE MULTIPLIER			
(1) x1	(2) x0.1	(3) x0.01	(4) x0.001
COUNTER A DECIMAL POINT & LEADING ZERO BLANKING			
(1) 0		(-1) 0 0 0 0 0 0	(NO L.Z.B.)
(2) 0.0		(-2) 0 0 0 0 0.0	
(3) 0.0 0		(-3) 0 0 0 0.0 0	
(4) 0.0 0 0		(-4) 0 0 0.0 0 0	
(5) 0.0 0 0 0		(-5) 0 0.0 0 0 0	
(6) 0.0 0 0 0 0		(-6) 0.0 0 0 0 0	

"OPERATOR ACCESSIBLE FUNCTIONS" MODES				
(With "PGM. DIS." terminal to "COMM")				
MODE	PRESET VALUE	SCALE FACTORS	COUNTER LOAD VALUE	RESET BUTTON & TERMINAL
(1)				●
(-1)				
(2)	●			●
(-2)	●			
(3)		●		●
(-3)		●		
(4)	●	●		●
(-4)	●	●		
(5)	●		●	●
(-5)	●		●	
(6)	●	●	●	●
(-6)	●	●	●	

☆ Entering a [41 -1], at any time will load factory settings for all modes.

GEMINI 4200 PROGRAMMING

SOME NOTES & HINTS ON PROGRAMMING THE GEMINI 4200

1. Be systematic about programming! Plan out the exact features & functions you need for your application. Write out the code entries you need from start to finish, and then enter the codes completely. Don't start in the middle of the program codes & make arbitrary entries to "see what it will do." This is a sure way to create confusing results. Finally, after you are done, record your program & file it where you can find it later if you want to make changes. You can use this card to write in your codes in the program ladder on the reverse side, together with any fixed data entries, for convenient future reference.

2. Watch out for conflicting modes! The programs in the GEMINI 4200 have been written to prevent illegal code entry.

However, to provide optimum flexibility, some reliance must be placed on the programmer to avoid conflicting codes.

3. The GEMINI 4200 can be interrogated at any time to see what modes & data entries have been made. Such interrogation can be made during a counting cycle without interrupting the normal counting process. In the lockout mode, all functions can also be interrogated, but those functions locked out cannot be changed. Making changes in program modes or data during a run is not recommended since mid-cycle changes can result in unanticipated outputs for that particular cycle.

PROGRAMMING PROCEDURE FOR FUNCTION & MODE SELECTION ☆ (Applies To Programming Chart)

To enter a programmable function or mode, enter the function selector code desired and then select the particular mode identifier required.

For example, to set up a decimal point to display a reading in 1/100ths with leading zero blanking, function selector code #46 must be entered. (See codes on reverse side.)

Press button #4, then button #6. The display will temporarily interrupt its normal readout (without interfering with the normal operation of the unit).

It will then display the entered code on the L.H. side.

[46] (DISPLAY READOUT)

Next, enter the mode identifier (button #3) that defines the decimal point location & LZB condition. This code is displayed on the right.

[46 3] (DISPLAY READOUT)

Now, enter this new selection by pressing the "E" button.

PROGRAMMING PROCEDURE FOR DATA ENTRY

In data entry, the front panel pushbuttons are identified by two different sets of references and will cause two different reactions in the course of making a data entry.

In the first phase of a data entry cycle, the particular data entry mode is called up by pushing the buttons identified by their panel markings. (i.e. Buttons "5", "3", or "1"). Once the data entry mode has been entered, the existing data appears on the display and the buttons below the display reference themselves to the digits directly above each button. The data can then be changed a digit at a time by depressing the button directly below the digits to be changed.

After the new data value is obtained, the "E" button is depressed to enter the new value.

[53,55] TIMED OUTPUT VALUES ☆

Entering Code "53" or "55" will call up the Timed Output 1 or 2 Value in seconds & hundredths. The value can be set to the new value by incrementing each digit with the button underneath that digit.

Press the "E" button to enter the new Timed Output value. (Max. Timed Output value = 599.99 sec.)

[3] SCALE FACTORS

One stroke of the "3" button calls up the existing Scale Factor for the currently displayed count or rate value. (The Scale Factor is the multiplier used to convert the actual count or rate to the direct readout display). The value can be changed by incrementing each digit with the button below it. Pressing the "E" key enters the new S.F. The S.F. can be set at any value from +/- 0.0001 to +/-5.9999. (Positive only for Rate Scale Factor A.)

[1,2] PRESETS

One stroke of the "1" or "2" button calls up the preset 1 or 2 value, which can then be changed by incrementing each digit with the button below it. Press the "E" button to enter the new Preset.

☆ Program before connecting "PGM. DIS." to "COMMON".

SELF TEST ROUTINE 6, +/-

Depressing "6" & then "+/-" starts the self test routine by lighting all decimal points, then all 9's, all 8's, all 7's etc., until alternate 8's & 9's are displayed. At this time, the output can be manually activated for testing by pressing the "1" or "2" button. (The Output test is disable when

"PGM. DIS." terminal is pulled to "COMMON".) An automatic exit will occur six (6) seconds after the Test Mode is completed. Test Mode can be run at any time and will not interfere with the normal operation of the Gemini 4200.