

I/O SSRs That Mount to OMRON's G7TC I/O Block

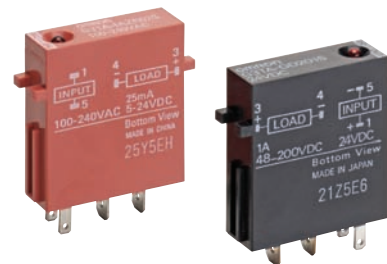

- Input and output modules are available in wide variety.
- Snaps easily into P7TF I/O Terminals and can be used together with G7T I/O relays.
- Operation of each SSR can be monitored easily through an LED indicator.
- Models certified for UL and CSA added to the series ("-US" models).

Refer to *Safety Precautions for All Solid State Relays*.



For the most recent information on models that have been certified for safety standards, refer to your OMRON website.

Model Number Structure

Model Number Legend

G3TA□□□□□□□□-□

1 2 3 4 5 6 7 8 9 10

1. Basic Model Name

G3T: I/O Solid State Relay

2. Structure

A: Socket type for PCB

3. I/O

I: Input models

O: Output models

4. Type

A: Input models: AC input
Output models: AC output

D: Input models: DC input
Output models: DC output

5. Rated Load Power Supply Voltage

2: 200 VAC/200 VDC

X: 50 to 100 V

Z: 26 V max.

6. Rated Load Current

01: 1 A

02: 2 A

R02: 25 mA

7. Terminal Type

S: Plug-in terminals

8. Zero Cross Function

Blank: DC output models

Z: Equipped with zero cross function

L: Not equipped with zero cross function

9. Operation Indicator

Blank: Equipped with operation indicator

M: Not equipped with operation indicator

10. Certification

US: Certified by UL and CSA

Ordering Information

List of Models

Input Modules

Isolation	Indicator	Logic level		Rated input voltage	Model
		Supply voltage	Supply current		
Photocoupler	Yes	4 to 32 VDC	25 mA	100 to 240 VAC	G3TA-IAZR02S-US
				5 to 24 VDC	G3TA-IDZR02S-US
	No		4 to 24 VDC	G3TA-IDZR02SM-US	

Note: When ordering, specify the rated input voltage.

Output Modules

Isolation	Zero cross function	Indicator	Rated output load	Rated input voltage	Model
Phototriac	Yes	Yes	2 A at 100 to 240 VAC at 60°C	12 VDC	G3TA-OA202SZ-US
				24 VDC	
	No			12 VDC	G3TA-OA202SL-US
				24 VDC	
Photocoupler	---	---	2 A at 5 to 48 VDC at 60°C	12 VDC	G3TA-ODX02S-US
				24 VDC	
			1 A at 48 to 200 VDC at 40°C	12 VDC	G3TA-OD201S-US
				24 VDC	

Note: 1. For information on products that are certified for international standards, consult your OMRON sales representatives. (Models certified for UL and CSA standards have "-US" at the end of the model number.)

2. Input Modules are mainly suitable for signal input to PLCs. For load switching, consider using an Output Module.

I/O Indication

The modules are classified as Input Modules and Output Modules according to the main application of the Module.

I/O module classification and AC/DC use are indicated on the mark affixed to the top of the product.

Mark attached to the top of product



Mark indication	Specification
AC IN	Input module, AC input
DC IN	Input module, DC input
AC OUT	Output module, AC output
DC OUT	Output module, DC output

■ Accessories (Order Separately)

Connecting Socket

I/O classification	Rated voltage	Model
Input (NPN, – common)	12 VDC	P7TF-IS16
	24 VDC	
	100/110 VDC	
	100/110 VAC	
	200/220 VAC	
Output (NPN, + common)	12 VDC	P7TF-OS16
	24 VDC	
Output (PNP, – common)	12 VDC	P7TF-OS16-1
	24 VDC	
Output (NPN, + common)	12 VDC	P7TF-OS08
	24 VDC	
---	---	P7TF-05

Specifications

■ Ratings (at an Ambient Temperature of 25°C)

Input Module

Input

Model	Rated voltage	Operating voltage	Input current	Voltage level	
				Must operate voltage	Must release voltage
G3TA-IAZR02S-US	100 to 240 VAC	80 to 264 VAC	5 mA max.	80 VAC max.	10 VAC min.
G3TA-IDZR02S-US	5 to 24 VDC	4 to 32 VDC		4 VDC max.	1 VDC min.
G3TA-IDZR02SM-US	4 to 24 VDC	3 to 32 VDC		3 VDC max.	

Output

Model	Logic level supply voltage	Output breakdown voltage	Output current	Output current (load current)	V _{CEO} (reference value)
G3TA-IAZR02S-US	4 to 32 VDC	32 VDC max.	25 mA max.	0.1 to 25 mA	80 V
G3TA-IDZR02S-US					
G3TA-IDZR02SM-US					

Output Module

Input

Model	Rated voltage	Operating voltage	Input impedance	Voltage level	
				Must operate voltage	Must release voltage
G3TA-OA202SZ-US	12 VDC	9.6 to 13.2 VDC	0.9 kΩ±20%	9.6 VDC max.	2 VDC min.
	24 VDC	19.2 to 26.4 VDC	1.7 kΩ±20%	19.2 VDC max.	
G3TA-OA202SL-US	12 VDC	9.6 to 13.2 VDC	0.9 kΩ±20%	9.6 VDC max.	
	24 VDC	19.2 to 26.4 VDC	1.7 kΩ±20%	19.2 VDC max.	
G3TA-ODX02S-US	12 VDC	9.6 to 13.2 VDC	3.5 kΩ±20%	9.6 VDC max.	
	24 VDC	19.2 to 26.4 VDC	6.5 kΩ±20%	19.2 VDC max.	
G3TA-OD201S-US	12 VDC	9.6 to 13.2 VDC	3.6 kΩ±20%	9.6 VDC max.	
	24 VDC	19.2 to 26.4 VDC	6.4 kΩ±20%	19.2 VDC max.	

Output

Model	Rated load voltage	Load voltage range	Load current (See note.)	Inrush current	V _{DRM} , V _{CEO} (reference value)
G3TA-OA202SZ-US	100 to 240 VAC	75 to 264 VAC	0.05 to 2 A	30 A (60 Hz, 1 cycle)	600 (V _{DRM})
G3TA-OA202SL-US	100 to 240 VAC	75 to 264 VAC			
G3TA-ODX02S-US	5 to 48 VDC	4 to 60 VDC	0.01 to 2 A	12 A (10 ms)	80 (V _{CEO})
G3TA-OD201S-US	48 to 200 VDC	40 to 200 VDC	0.01 to 1 A	6 A (10 ms)	400 (V _{CEO})

Note: The minimum current value is measured at 10°C min.

■ Characteristics

Input Module

Item	G3TA-IAZR02S-US	G3TA-IDZR02S-US	G3TA-IDZR02SM-US
Operate time	20 ms max.	0.5 ms max.	
Release time	20 ms max.	0.5 ms max.	
Output ON voltage drop	1.6 V max.	1.6 V max.	
Leakage current	5 μ A max.		
Insulation resistance	100 M Ω min. (at 500 VDC)		
Dielectric strength	4,000 VAC, 50/60 Hz for 1 min between input and output		
Vibration resistance	Malfunction: 10 to 55 to 10 Hz, 0.75-mm single amplitude		
Shock resistance	Malfunction: 1,000 m/s ²		
Ambient temperature	Operating: -30°C to 80°C (with no icing or condensation) Storage: -30°C to 100°C (with no icing or condensation)		
Ambient humidity	Operating: 45% to 85%		
Certified standards	UL508 file No. E64562/CSA C22.2 (No. 0, No. 14) file No. LR35535		
Weight	Approx. 16 g		

Output Module

Item	G3TA-OA202SZ-US	G3TA-OA202SL-US	G3TA-ODX02S-US	G3TA-OD201S-US
Operate time	1/2 of load power source cycle + 1 ms max.	1 ms max.	0.5 ms max.	2 ms max.
Release time	1/2 of load power source cycle + 1 ms max.		2 ms max.	2 ms max.
Output ON voltage drop	1.6 V rms max.		1.6 V max.	2.5 V max.
Leakage current	5 mA max. (at 200 VAC)		1 mA max.	
Insulation resistance	100 M Ω min. (at 500 VDC)			
Dielectric strength	4,000 VAC, 50/60 Hz for 1 min between input and output			
Vibration resistance	Malfunction: 10 to 55 to 10 Hz, 0.75-mm single amplitude			
Shock resistance	Malfunction: 1,000 m/s ²			
Ambient temperature	Operating: -30°C to 80°C (with no icing or condensation) Storage: -30°C to 100°C (with no icing or condensation)			
Ambient humidity	Operating: 45% to 85%			
Certified standards	UL508 file No. E64562, CSA C22.2 (No. 14) file No. LR3553			
Weight	Approx. 23 g			

With up to four G3TA SSRs mounted before G7T Relays, switching is possible at the rated load current for each Relay.

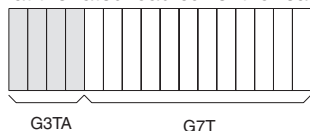

With G3TA SSRs mounted before every other G7T Relays, switching is possible at the rated load current for each Relay.

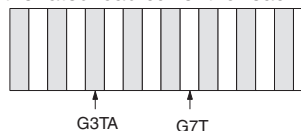

Engineering Data

Load Current vs. Ambient Temperature Characteristics

G3TA-OA202SZ/OA202SL/ODX02S-US

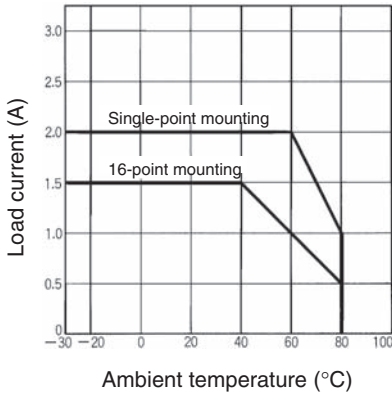

G3TA-OD201S-US

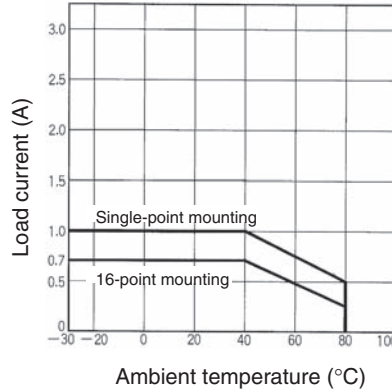

One Cycle Surge Current: Non-repetitive

Non-repetitive (Keep the inrush current to half the rated value if it occurs repetitively.)

G3TA-OA202SZ/OA202SL-US

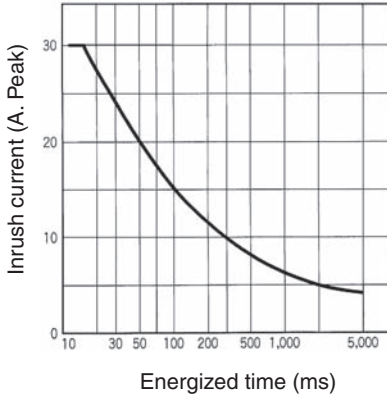

G3TA-ODX02S-US

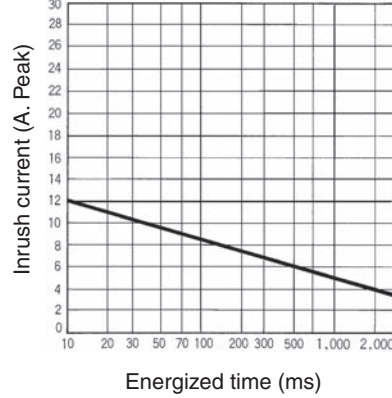

G3TA-OD201S-US

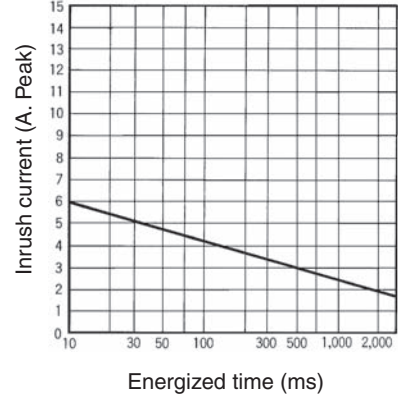

Connections

External Connections (Bottom View)

G3TA-IAZR02S

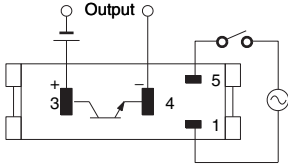

G3TA-IDZR02S/IDZR02SM

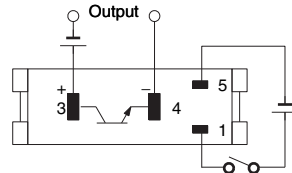

G3TA-OA

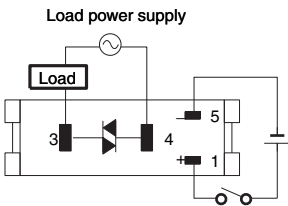

G3TA-OD

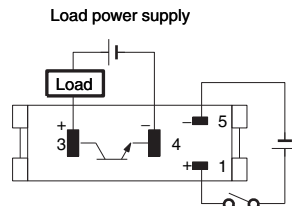

Note: The load is possible to connect either + side or - side.

Circuit Configurations

I/O module classification	Model	Case color	Operation indicator	Circuit
AC output	G3TA-OA202SZ (with zero cross) G3TA-OA202SL (without zero cross)	Black	yes	
DC output	G3TA-ODX02S G3TA-OD201S	Black	yes	
AC input	G3TA-IAZR02S	Red	yes	
DC input	G3TA-IDZR02S	Green	yes	
	G3TA-IDZR02SM		No	

Dimensions

Note: All units are in millimeters unless otherwise indicated.

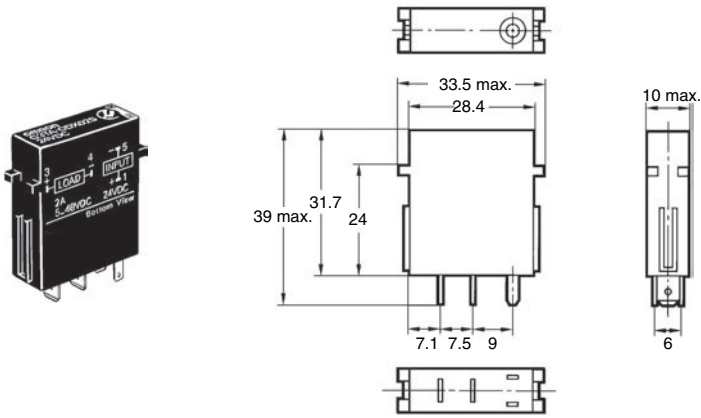

Connecting Sockets

For Input (NPN, - Common)
P7TF-IS16

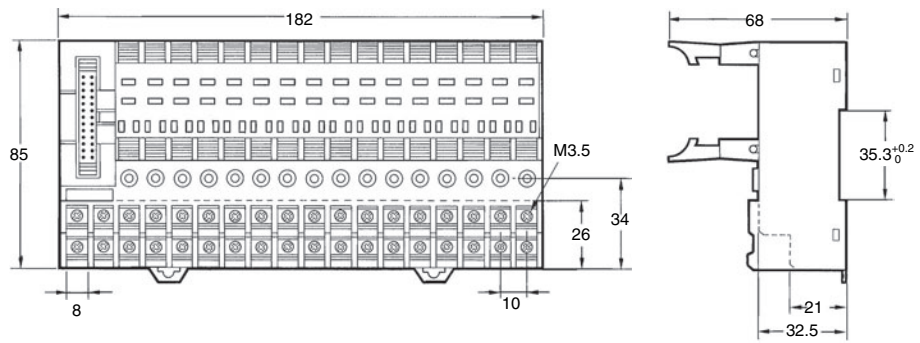
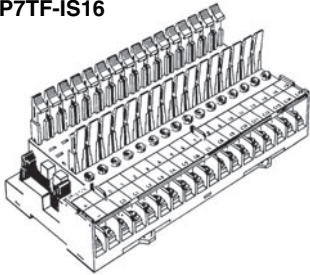

**For Output (NPN, + Common)
P7TF-OS16**

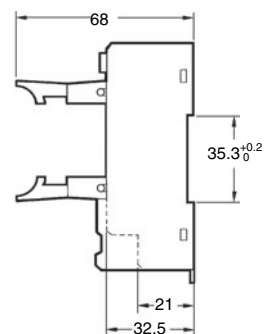
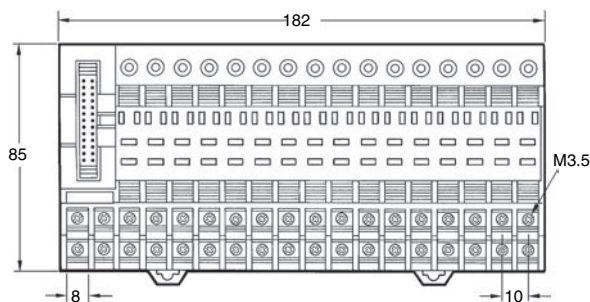
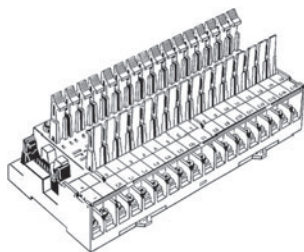

**For Output (PNP, + Common)
P7TF-OS08**

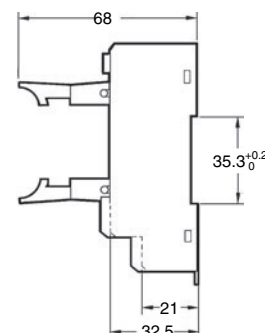
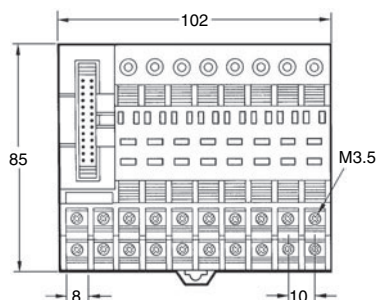
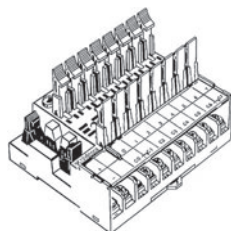

P7TF-O5

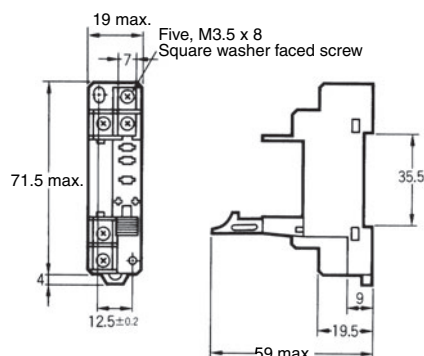
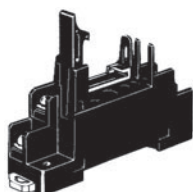

Safety Precautions

Refer to *Safety Precautions for All Solid State Relays*.

■ Precautions for Correct Use

Please observe the following precautions to prevent failure to operate, malfunction, or undesirable effect on product performance.

Connection

With the SSR for DC switching, the load can be connected to either positive or negative output terminal of the SSR.

Protective Component

Since the SSR does not incorporate an overvoltage absorption component, be sure to connect an overvoltage absorption component when using the SSR under an inductive load.

ALL DIMENSIONS SHOWN ARE IN MILLIMETERS.
To convert millimeters into inches, multiply by 0.03937. To convert grams into ounces, multiply by 0.03527.

In the interest of product improvement, specifications are subject to change without notice.

Terms and Conditions Agreement

Read and understand this catalog.

Please read and understand this catalog before purchasing the products. Please consult your OMRON representative if you have any questions or comments.

Warranties.

(a) Exclusive Warranty. Omron's exclusive warranty is that the Products will be free from defects in materials and workmanship for a period of twelve months from the date of sale by Omron (or such other period expressed in writing by Omron). Omron disclaims all other warranties, express or implied.

(b) Limitations. OMRON MAKES NO WARRANTY OR REPRESENTATION, EXPRESS OR IMPLIED, ABOUT NON-INFRINGEMENT, MERCHANTABILITY OR FITNESS FOR A PARTICULAR PURPOSE OF THE PRODUCTS. BUYER ACKNOWLEDGES THAT IT ALONE HAS DETERMINED THAT THE PRODUCTS WILL SUITABLY MEET THE REQUIREMENTS OF THEIR INTENDED USE.

Omron further disclaims all warranties and responsibility of any type for claims or expenses based on infringement by the Products or otherwise of any intellectual property right. (c) Buyer Remedy. Omron's sole obligation hereunder shall be, at Omron's election, to (i) replace (in the form originally shipped with Buyer responsible for labor charges for removal or replacement thereof) the non-complying Product, (ii) repair the non-complying Product, or (iii) repay or credit Buyer an amount equal to the purchase price of the non-complying Product; provided that in no event shall Omron be responsible for warranty, repair, indemnity or any other claims or expenses regarding the Products unless Omron's analysis confirms that the Products were properly handled, stored, installed and maintained and not subject to contamination, abuse, misuse or inappropriate modification. Return of any Products by Buyer must be approved in writing by Omron before shipment. Omron Companies shall not be liable for the suitability or unsuitability or the results from the use of Products in combination with any electrical or electronic components, circuits, system assemblies or any other materials or substances or environments. Any advice, recommendations or information given orally or in writing, are not to be construed as an amendment or addition to the above warranty.

See <http://www.omron.com/global/> or contact your Omron representative for published information.

Limitation on Liability: Etc.

OMRON COMPANIES SHALL NOT BE LIABLE FOR SPECIAL, INDIRECT, INCIDENTAL, OR CONSEQUENTIAL DAMAGES, LOSS OF PROFITS OR PRODUCTION OR COMMERCIAL LOSS IN ANY WAY CONNECTED WITH THE PRODUCTS, WHETHER SUCH CLAIM IS BASED IN CONTRACT, WARRANTY, NEGLIGENCE OR STRICT LIABILITY.

Further, in no event shall liability of Omron Companies exceed the individual price of the Product on which liability is asserted.

Suitability of Use.

Omron Companies shall not be responsible for conformity with any standards, codes or regulations which apply to the combination of the Product in the Buyer's application or use of the Product. At Buyer's request, Omron will provide applicable third party certification documents identifying ratings and limitations of use which apply to the Product. This information by itself is not sufficient for a complete determination of the suitability of the Product in combination with the end product, machine, system, or other application or use. Buyer shall be solely responsible for determining appropriateness of the particular Product with respect to Buyer's application, product or system. Buyer shall take application responsibility in all cases.

NEVER USE THE PRODUCT FOR AN APPLICATION INVOLVING SERIOUS RISK TO LIFE OR PROPERTY OR IN LARGE QUANTITIES WITHOUT ENSURING THAT THE SYSTEM AS A WHOLE HAS BEEN DESIGNED TO ADDRESS THE RISKS, AND THAT THE OMRON PRODUCT(S) IS PROPERLY RATED AND INSTALLED FOR THE INTENDED USE WITHIN THE OVERALL EQUIPMENT OR SYSTEM.

Programmable Products.

Omron Companies shall not be responsible for the user's programming of a programmable Product, or any consequence thereof.

Performance Data.

Data presented in Omron Company websites, catalogs and other materials is provided as a guide for the user in determining suitability and does not constitute a warranty. It may represent the result of Omron's test conditions, and the user must correlate it to actual application requirements. Actual performance is subject to the Omron's Warranty and Limitations of Liability.

Change in Specifications.

Product specifications and accessories may be changed at any time based on improvements and other reasons. It is our practice to change part numbers when published ratings or features are changed, or when significant construction changes are made. However, some specifications of the Product may be changed without any notice. When in doubt, special part numbers may be assigned to fix or establish key specifications for your application. Please consult with your Omron's representative at any time to confirm actual specifications of purchased Product.

Errors and Omissions.

Information presented by Omron Companies has been checked and is believed to be accurate; however, no responsibility is assumed for clerical, typographical or proofreading errors or omissions.