

THT Common Mode Chokes

PA4415NL and PA4416NL

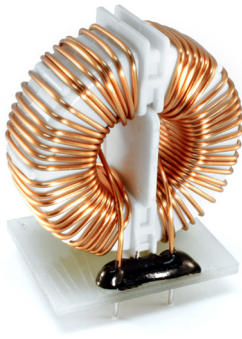

- Dielectric Strength: 1500Vrms
- Inductance Range: 14 mH (at 8A) to 35mH (at 5A)
- Height: 46.0 mm Max
- Footprint: 43.0 mm x 26.0 mm
- Voltage Rating: 250 Vac Max, 1500 Vrms Hi-pot

Electrical Specifications @ 25°C - Operating Temperature -40°C to +125°C

Part Number	Inductance (1-4)=(2-3) (mH Min)	Current Rating ¹ (1-4)=(2-3) (A)	DCR (1-4)=(2-3) (mΩ Max)	Self Resonant Frequency (1,2-4,3) (MHz Typ)	Impedance (kOhms Typ at SRF)
PA4415NL	24.5	5.00	90.0	0.92	29.4
PA4416NL	9.8	8.00	27.0	1.96	13.8

Notes:

- The current rating (I_{rated}) is based upon the temperature rise of the component and represents the rms current which will cause a typical temperature rise of 55°C.
- The temperature of the component (ambient plus temperature rise) must be within the stated operating temperature range.

Mechanical

Schematic

PA441xNL

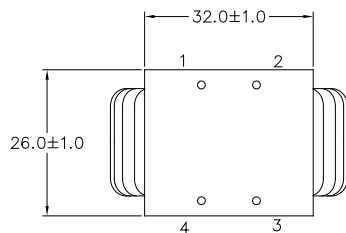
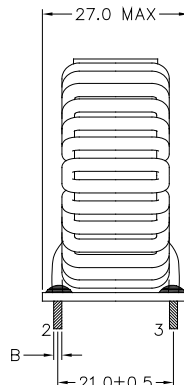
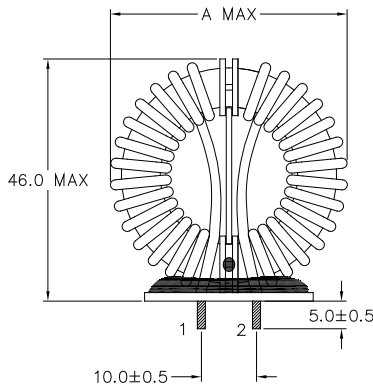

DIMENSION	"A"	"B"	"C"
PA4415NL	42MAX	∅0.8±0.1	∅1.2
PA4416NL	43MAX	∅1.2±0.1	∅1.6

ALL DIMENSIONS ARE IN MM.

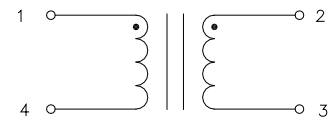

SCHEMATIC

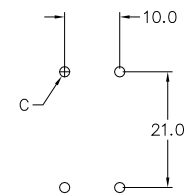

SUGGESTED LAND PATTERN

USA +858 674 8100

Germany +49 7032 7806 0

Singapore +65 6287 8998

Shanghai +86 21 62787060

China +86 755 33966678

Taiwan +886 3 4356768

THT Common Mode Chokes

PA4415NL and PA4416NL

Impedance vs Frequency, PA4415NL, PA4416NL

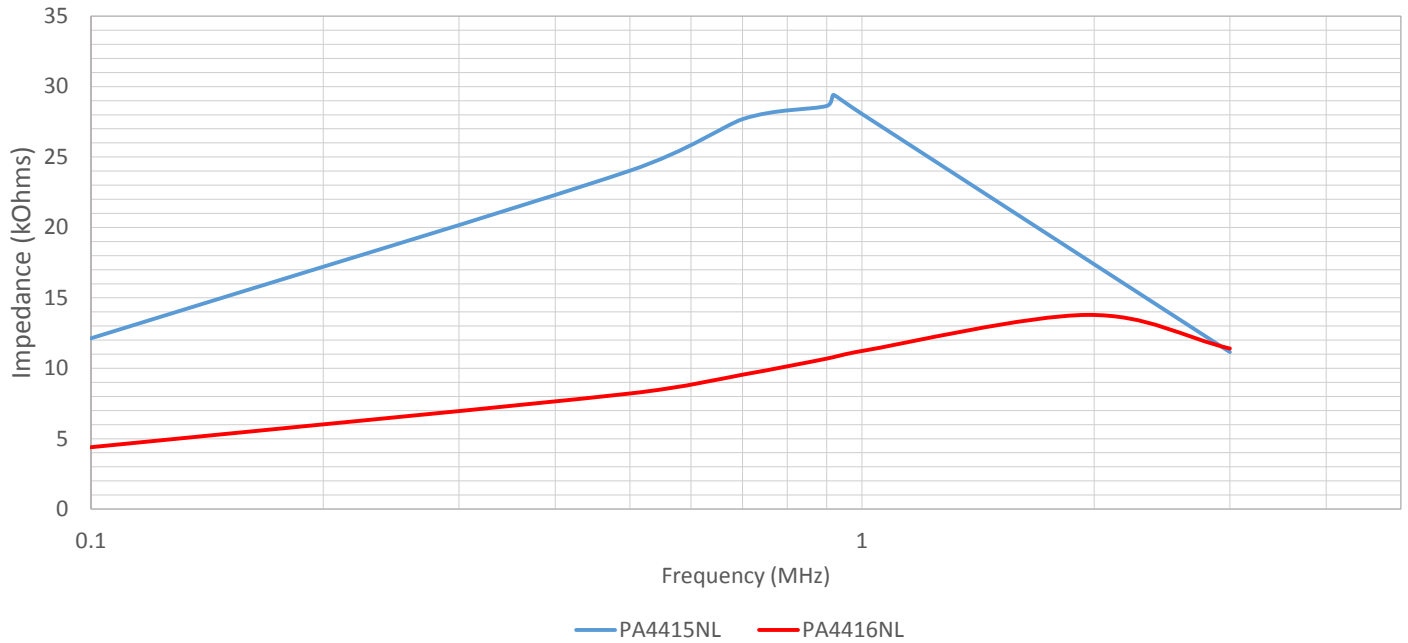

For More Information

Pulse Worldwide Headquarters

12220 World Trade Drive
San Diego, CA 92128
U.S.A.

Tel: 858 674 8100
Fax: 858 674 8262

Pulse Europe

Einsteinstrasse 1
D-71083 Herrenberg
Germany

Tel: 49 7032 7806 0
Fax: 49 7032 7806 135

Pulse China Headquarters

B402, Shenzhen Academy of
Aerospace Technology Bldg.
10th Kejinan Road
High-Tech Zone
Nanshan District
Shenzhen, PR China 518057

Tel: 86 755 33966678
Fax: 86 755 33966700

Pulse North China

Room 2704/2705
Super Ocean Finance Ctr.
2067 Yan An Road West
Shanghai 200336
China

Tel: 86 21 62787060
Fax: 86 21 62786973

Pulse South Asia

135 Joo Seng Road
#03-02
PM Industrial Bldg.
Singapore 368363

Tel: 65 6287 8998
Fax: 65 6287 8998

Pulse North Asia

3F, No. 198
Zhongyuan Road
Zhongli City
Taoyuan County 320
Taiwan R. O. C.

Tel: 886 3 4356768
Fax: 886 3 4356823 (Pulse)
Fax: 886 3 4356820 (FRE)

Performance warranty of products offered on this data sheet is limited to the parameters specified. Data is subject to change without notice. Other brand and product names mentioned herein may be trademarks or registered trademarks of their respective owners. © Copyright, 2016. Pulse Electronics, Inc. All rights reserved.