

### CMF16-153131

**Description:**

The CMF16 Series provides exceptional common-mode suppression and exceptional stray inductance to suppress differential-mode noise. In effect, the CMF16 Series combines the features of two separate components into one.

**Construction:**

Constructed with UL rated 130°C (Class B) materials.

**Electrical Specifications (@20°C) @ 10kHz**

Inductance(1)	L <sub>stray typ</sub>	Amps(2) (A)	Max. DC (Ω) Resistance
15mH	290uH	1.3	0.47

1. Inductance Tolerance: -30/+50%
2. Inductance per winding.
3. Operating Temperature: -40 – 105°C
4. Storage Temperature: -25°C – +40°C, ≤ 75% RH
5. Rated Voltage: 300VAC (50/60Hz)
6. Weight: 9g

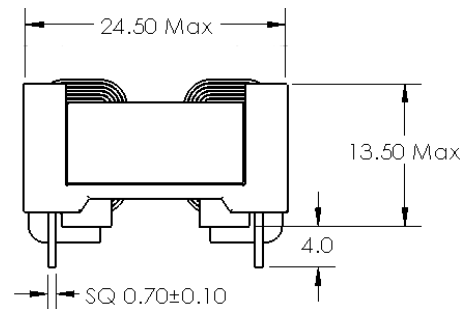

**CMF16 Series – Frequency Response Curve**

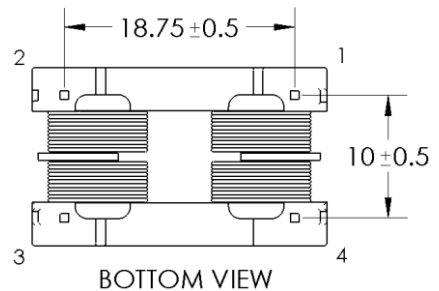
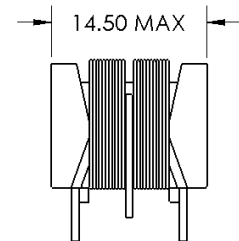
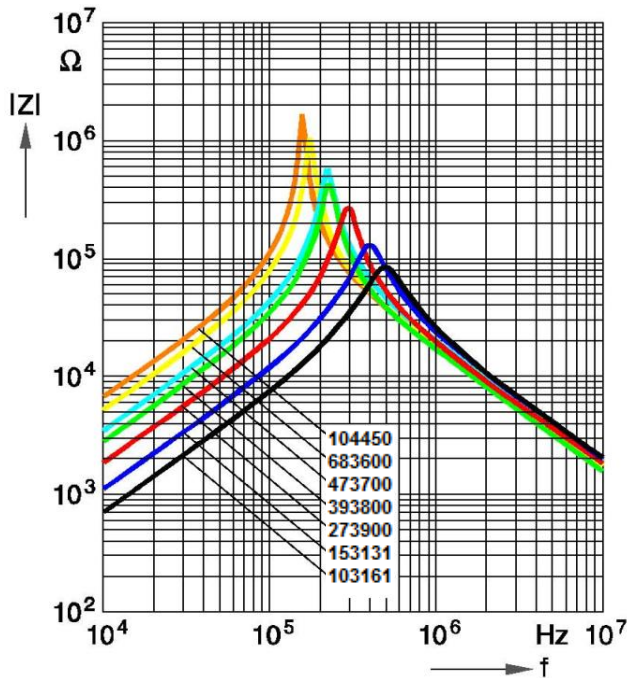

**Safety:** 2000VAC Dielectric Strength between windings.

**RoHS Compliance:** As of manufacturing date February 2005, all standard products meet the requirements of 2011/65/EU, known as the RoHS initiative.

\*Upon printing, this document is considered “uncontrolled”. Please contact Triad Magnetics website for the most current version. For soldering and washing information please see <http://www.triadmagnetics.com>

