

# LM561B – 5630 Middle Power LED



## Introduction

### Features

- Beam Angle: 120°
- Precondition : JEDEC Level 2a
- Dimension : 5.6 x 3.0 x 0.8 mm
- ESD withstand Voltage : up to  $\pm 5$ KV [HBM]

### Applications

- INDOOR LIGHTING : Ambient Light, LED tube, Down light, LED bulb and Ceiling Light

Simpex Electronic AG  
Binzackerstrasse 33  
CH-8622 Wetzikon  
Telefon +41-44-931 10 40  
Telefax +41-44-931 10 41

www.simpex.ch  
contact@simpex.ch  
MwSt Nr. 235 049



## SAMSUNG ELECTRONICS

95, Samsung2-Ro, Giheung-Gu,  
Yongin-City, Gyeonggi-Do 446-711, KOREA

Copyright © 1995-2013 SAMSUNG ELECTRONICS Co.,Ltd. All rights reserved. The information in this document is subject to change without notice. SAMSUNG,  SAMSUNG is a registered trademark of SAMSUNG ELECTRONICS.

## Contents

1. Product Code Information	-----	3
2. Characteristics	-----	9
3. Typical Characteristics Graph	-----	10
4. Outline Drawing & Dimension	-----	16
5. Reliability Test Items & Conditions	-----	17
6. Solder Conditions	-----	18
7. Tape & Reel	-----	19
8. Label Structure	-----	20
9. Packing Structure	-----	21
10. Precaution For Use	-----	23
11. Hazard Substance Analysis Report	-----	26
Revision History	-----	46

# 1. Product Code Information

## 1) Luminous Flux Bins ( $T_s = 25^\circ\text{C}$ )

Nominal CCT	Product Code	Flux Rank	Sorting Condition $I_m$ @65mA
			Flux Range ( $\Phi_v, I_m$ )
2700K	SPMWHT541MD5WAW0S1	S1	24.0 ~ 26.0
	SPMWHT541MD5WAW0S2	S2	26.0 ~ 28.0
	SPMWHT541MD5WAW0S3	S3	28.0 ~ 30.0
3000K	SPMWHT541MD5WAV0S1	S1	24.5 ~ 26.5
	SPMWHT541MD5WAV0S2	S2	26.5 ~ 28.5
	SPMWHT541MD5WAV0S3	S3	28.5 ~ 30.5
3500K	SPMWHT541MD5WAU0S1	S1	25.0 ~ 27.0
	SPMWHT541MD5WAU0S2	S2	27.0 ~ 29.0
	SPMWHT541MD5WAU0S3	S3	29.0 ~ 31.0
4000K	SPMWHT541MD5WAT0S1	S1	26.0 ~ 28.0
	SPMWHT541MD5WAT0S2	S2	28.0 ~ 30.0
	SPMWHT541MD5WAT0S3	S3	30.0 ~ 32.0
5000K	SPMWHT541MD5WAR0S1	S1	27.0 ~ 29.0
	SPMWHT541MD5WAR0S2	S2	29.0 ~ 31.0
	SPMWHT541MD5WAR0S3	S3	31.0 ~ 33.0
5700K	SPMWHT541MD5WAQ0S1	S1	26.5 ~ 28.5
	SPMWHT541MD5WAQ0S2	S2	28.5 ~ 30.5
	SPMWHT541MD5WAQ0S3	S3	30.5 ~ 32.5
6500K	SPMWHT541MD5WAP0S1	S1	26.0 ~ 28.0
	SPMWHT541MD5WAP0S2	S2	28.0 ~ 30.0
	SPMWHT541MD5WAP0S3	S3	30.0 ~ 32.0

**Notes:** SAMSUNG ELECTRONICS maintains a tolerance of  $\pm 5\%$  on Luminous Flux measurements

## 2) Color Bins ( $T_s = 25^\circ\text{C}$ )

### 1) Color Binning

Nominal CCT	Product Code	Color Rank	Chromaticity Bins
2700K	SPMWHT541MD5WAW0S1 SPMWHT541MD5WAW0S2 SPMWHT541MD5WAW0S3	W0(Whole bin)	W1, W2, W3, W4, W5, W6, W7, W8, W9, WA, WB, WC, WD, WE, WF, WG
3000K	SPMWHT541MD5WAV0S1 SPMWHT541MD5WAV0S2 SPMWHT541MD5WAV0S3	V0(Whole bin)	V1, V2, V3, V4, V5, V6, V7, V8, V9, VA, VB, VC, VD, VE, VF, VG
3500K	SPMWHT541MD5WAU0S1 SPMWHT541MD5WAU0S2 SPMWHT541MD5WAU0S3	U0(Whole bin)	U1, U2, U3, U4, U5, U6, U7, U8, U9, UA, UB, UC, UD, UE, UF, UG
4000K	SPMWHT541MD5WAT0S1 SPMWHT541MD5WAT0S2 SPMWHT541MD5WAT0S3	T0(Whole bin)	T1, T2, T3, T4, T5, T6, T7, T8, T9, TA, TB, TC, TD, TE, TF, TG
5000K	SPMWHT541MD5WAR0S1 SPMWHT541MD5WAR0S2 SPMWHT541MD5WAR0S3	R0(Whole bin)	R1, R2, R3, R4, R5 R6, R7, R8, R9 ,RA
5700K	SPMWHT541MD5WAQ0S1 SPMWHT541MD5WAQ0S2 SPMWHT541MD5WAQ0S3	Q0(Whole bin)	Q1, Q2, Q3, Q4, Q5 Q6, Q7, Q8, Q9, QA
6500K	SPMWHT541MD5WAP0S1 SPMWHT541MD5WAP0S2 SPMWHT541MD5WAP0S3	P0(Whole bin)	P1, P2, P3, P4, P5 P6, P7, P8, P9, PA

## 2) Chromaticity Region & Coordinates

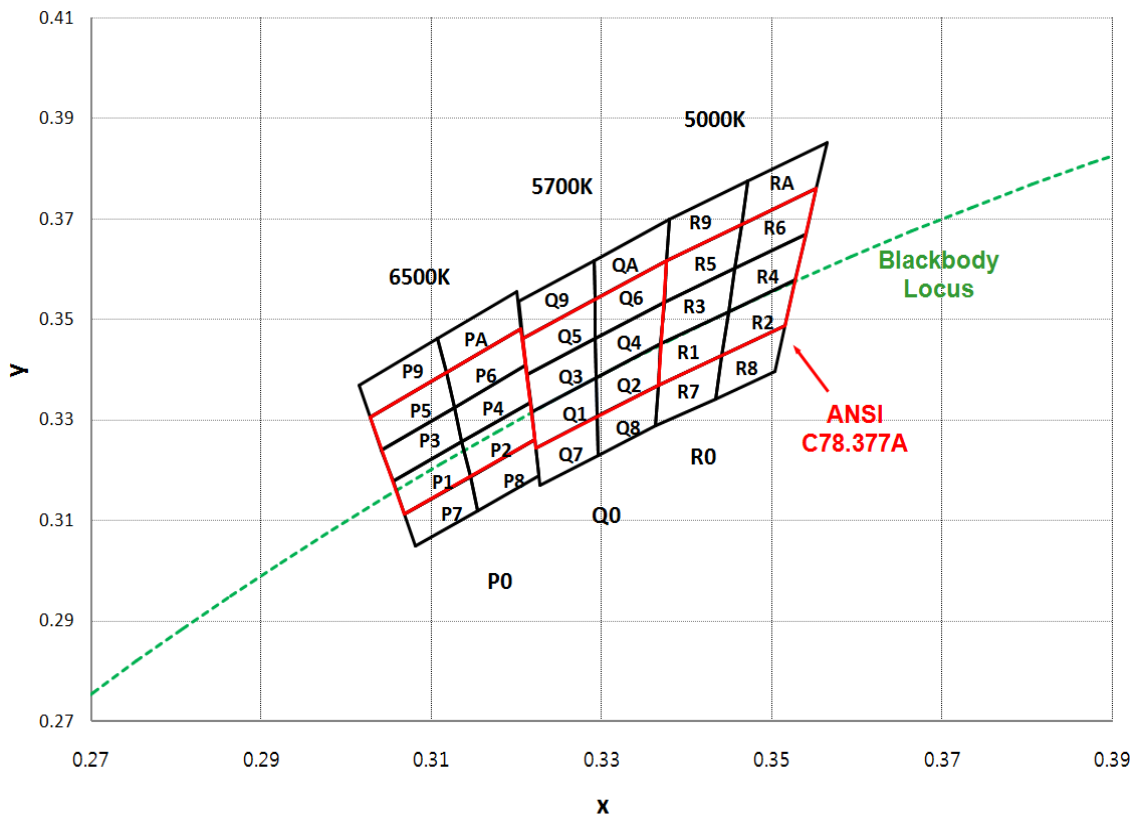
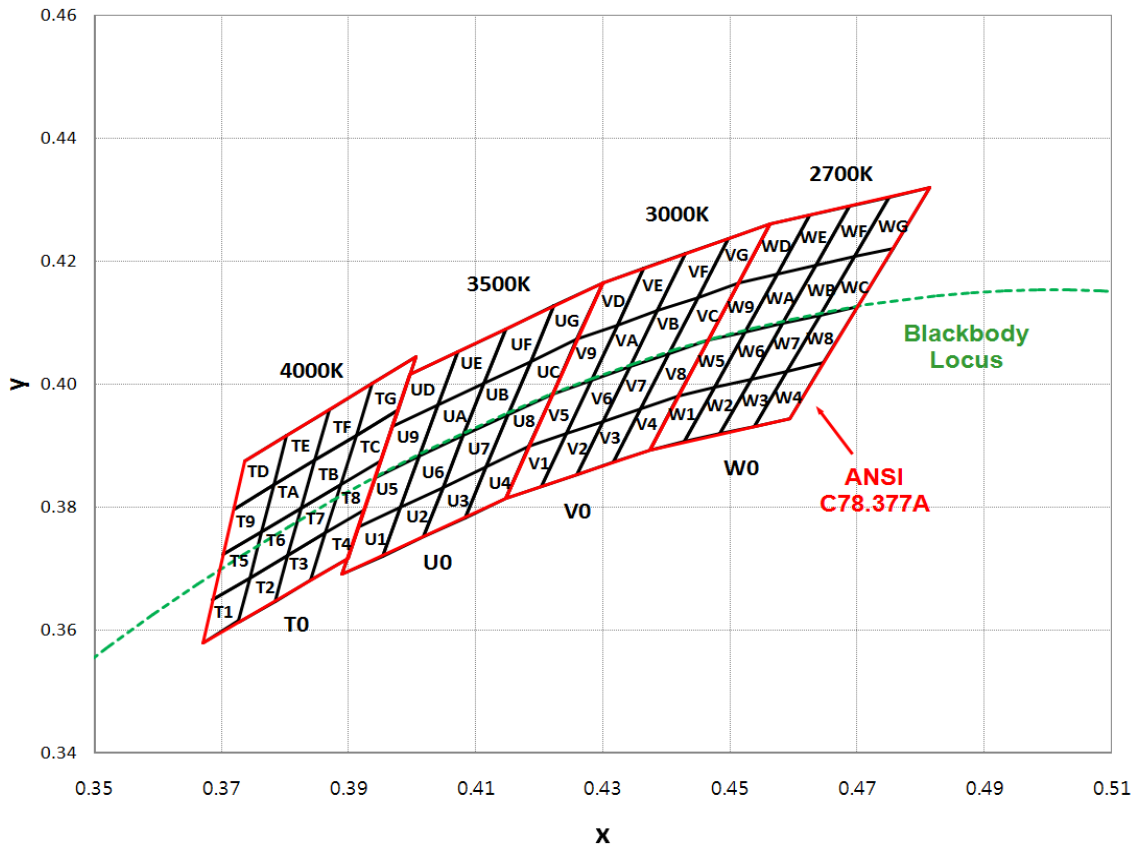



## 2) Chromaticity Region & Coordinates (Continued)

Region	CIE X	CIE Y	Region	CIE X	CIE Y
W rank (2700K)					
W1	0.4373	0.3893	W9	0.4465	0.4071
	0.4418	0.3981		0.4513	0.4164
	0.4475	0.3994		0.4573	0.4178
	0.4428	0.3906		0.4523	0.4085
W2	0.4428	0.3906	WA	0.4523	0.4085
	0.4475	0.3994		0.4573	0.4178
	0.4532	0.4008		0.4634	0.4193
	0.4483	0.3919		0.4582	0.4099
W3	0.4483	0.3919	WB	0.4582	0.4099
	0.4532	0.4008		0.4634	0.4193
	0.4589	0.4021		0.4695	0.4207
	0.4538	0.3931		0.4641	0.4112
W4	0.4538	0.3931	WC	0.4641	0.4112
	0.4589	0.4021		0.4695	0.4207
	0.4646	0.4034		0.4756	0.4221
	0.4593	0.3944		0.4700	0.4126
W5	0.4418	0.3981	WD	0.4513	0.4164
	0.4465	0.4071		0.4562	0.4260
	0.4523	0.4085		0.4624	0.4274
	0.4475	0.3994		0.4573	0.4178
W6	0.4475	0.3994	WE	0.4573	0.4178
	0.4523	0.4085		0.4624	0.4274
	0.4582	0.4099		0.4687	0.4289
	0.4532	0.4008		0.4634	0.4193
W7	0.4532	0.4008	WF	0.4634	0.4193
	0.4582	0.4099		0.4687	0.4289
	0.4641	0.4112		0.4750	0.4304
	0.4589	0.4021		0.4695	0.4207
W8	0.4589	0.4021	WG	0.4695	0.4207
	0.4641	0.4112		0.4750	0.4304
	0.4700	0.4126		0.4813	0.4319
	0.4646	0.4034		0.4756	0.4221

Region	CIE X	CIE Y	Region	CIE X	CIE Y
V rank (3000K)					
V1	0.4147	0.3814	V9	0.4221	0.3984
	0.4183	0.3898		0.4259	0.4073
	0.4242	0.3919		0.4322	0.4096
	0.4203	0.3833		0.4281	0.4006
V2	0.4203	0.3833	VA	0.4281	0.4006
	0.4242	0.3919		0.4322	0.4096
	0.4300	0.3939		0.4385	0.4119
	0.4259	0.3853		0.4342	0.4028
V3	0.4259	0.3853	VB	0.4342	0.4028
	0.4300	0.3939		0.4385	0.4119
	0.4359	0.3960		0.4449	0.4141
	0.4316	0.3873		0.4403	0.4049
V4	0.4316	0.3873	VC	0.4403	0.4049
	0.4359	0.3960		0.4449	0.4141
	0.4418	0.3981		0.4513	0.4164
	0.4373	0.3893		0.4465	0.4071
V5	0.4183	0.3898	VD	0.4259	0.4073
	0.4221	0.3984		0.4299	0.4165
	0.4281	0.4006		0.4364	0.4188
	0.4242	0.3919		0.4322	0.4096
V6	0.4242	0.3919	VE	0.4322	0.4096
	0.4281	0.4006		0.4364	0.4188
	0.4342	0.4028		0.4430	0.4212
	0.4300	0.3939		0.4385	0.4119
V7	0.4300	0.3939	VF	0.4385	0.4119
	0.4342	0.4028		0.4430	0.4212
	0.4403	0.4049		0.4496	0.4236
	0.4359	0.3960		0.4449	0.4141
V8	0.4359	0.3960	VG	0.4449	0.4141
	0.4403	0.4049		0.4496	0.4236
	0.4465	0.4071		0.4562	0.4260
	0.4418	0.3981		0.4513	0.4164

## 2) Chromaticity Region & Coordinates (Continued)

Region	CIE X	CIE Y	Region	CIE X	CIE Y
U rank (3500K)					
U1	0.3889	0.3690	U9	0.3941	0.3848
	0.3915	0.3768		0.3968	0.3930
	0.3981	0.3800		0.4040	0.3966
	0.3953	0.3720		0.4010	0.3882
U2	0.3953	0.3720	UA	0.4010	0.3882
	0.3981	0.3800		0.4040	0.3966
	0.4048	0.3832		0.4113	0.4001
	0.4017	0.3751		0.4080	0.3916
U3	0.4017	0.3751	UB	0.4080	0.3916
	0.4048	0.3832		0.4113	0.4001
	0.4116	0.3865		0.4186	0.4037
	0.4082	0.3782		0.4150	0.3950
U4	0.4082	0.3782	UC	0.4150	0.3950
	0.4116	0.3865		0.4186	0.4037
	0.4183	0.3898		0.4259	0.4073
	0.4147	0.3814		0.4221	0.3984
U5	0.3915	0.3768	UD	0.3968	0.3930
	0.3941	0.3848		0.3996	0.4015
	0.4010	0.3882		0.4071	0.4052
	0.3981	0.3800		0.4040	0.3966
U6	0.3981	0.3800	UE	0.4040	0.3966
	0.4010	0.3882		0.4071	0.4052
	0.4080	0.3916		0.4146	0.4089
	0.4048	0.3832		0.4113	0.4001
U7	0.4048	0.3832	UF	0.4113	0.4001
	0.4080	0.3916		0.4146	0.4089
	0.4150	0.3950		0.4222	0.4127
	0.4116	0.3865		0.4186	0.4037
U8	0.4116	0.3865	UG	0.4186	0.4037
	0.4150	0.3950		0.4222	0.4127
	0.4221	0.3984		0.4299	0.4165
	0.4183	0.3898		0.4259	0.4073

Region	CIE X	CIE Y	Region	CIE X	CIE Y
T rank (4000K)					
T1	0.367	0.3578	T9	0.3702	0.3722
	0.3726	0.3612		0.3763	0.376
	0.3744	0.3685		0.3782	0.3837
	0.3686	0.3649		0.3719	0.3797
T2	0.3726	0.3612	TA	0.3763	0.3760
	0.3783	0.3646		0.3825	0.3798
	0.3804	0.3721		0.3847	0.3877
	0.3744	0.3685		0.3782	0.3837
T3	0.3783	0.3646	TB	0.3825	0.3798
	0.3840	0.3681		0.3887	0.3836
	0.3863	0.3758		0.3912	0.3917
	0.3804	0.3721		0.3847	0.3877
T4	0.384	0.3681	TC	0.3887	0.3837
	0.3898	0.3716		0.395	0.3875
	0.3924	0.3794		0.3978	0.3958
	0.3863	0.3758		0.3912	0.3917
T5	0.3686	0.3649	TD	0.3719	0.3797
	0.3744	0.3685		0.3782	0.3837
	0.3763	0.376		0.3802	0.3916
	0.3702	0.3722		0.3736	0.3874
T6	0.3744	0.3685	TE	0.3782	0.3837
	0.3804	0.3721		0.3847	0.3877
	0.3825	0.3798		0.3869	0.3958
	0.3763	0.376		0.3802	0.3916
T7	0.3804	0.3721	TF	0.3847	0.3877
	0.3863	0.3758		0.3912	0.3917
	0.3887	0.3836		0.3937	0.4001
	0.3825	0.3798		0.3869	0.3958
T8	0.3863	0.3758	TG	0.3912	0.3917
	0.3924	0.3794		0.3978	0.3958
	0.395	0.3875		0.4006	0.4044
	0.3887	0.3836		0.3937	0.4001



## 2) Chromaticity Region & Coordinates (Continued)

Region	CIE X	CIE Y	Region	CIE X	CIE Y
R rank (5000K)					
R1	0.3366	0.3369	R6	0.3456	0.3601
	0.3441	0.3428		0.3539	0.3669
	0.3449	0.3515		0.3551	0.3760
	0.3369	0.3451		0.3464	0.3688
R2	0.3441	0.3428	R7	0.3363	0.3287
	0.3515	0.3487		0.3433	0.3341
	0.3527	0.3578		0.3441	0.3428
	0.3449	0.3515		0.3366	0.3369
R3	0.3369	0.3451	R8	0.3433	0.3341
	0.3449	0.3515		0.3503	0.3396
	0.3456	0.3601		0.3515	0.3487
	0.3373	0.3534		0.3441	0.3428
R4	0.3449	0.3515	R9	0.3376	0.3616
	0.3527	0.3578		0.3464	0.3688
	0.3539	0.3669		0.3471	0.3775
	0.3456	0.3601		0.3379	0.3698
R5	0.3373	0.3534	RA	0.3464	0.3688
	0.3456	0.3601		0.3551	0.3760
	0.3464	0.3688		0.3564	0.3851
	0.3376	0.3616		0.3471	0.3775
Q rank (5700K)					
Q1	0.3222	0.3243	Q6	0.3292	0.3461
	0.3294	0.3306		0.3373	0.3534
	0.3293	0.3384		0.3376	0.3616
	0.3217	0.3316		0.3292	0.3539
Q2	0.3294	0.3306	Q7	0.3227	0.3170
	0.3366	0.3369		0.3295	0.3228
	0.3369	0.3451		0.3294	0.3306
	0.3293	0.3384		0.3222	0.3243
Q3	0.3217	0.3316	Q8	0.3295	0.3228
	0.3293	0.3384		0.3363	0.3287
	0.3292	0.3461		0.3366	0.3369
	0.3212	0.3389		0.3294	0.3306
Q4	0.3293	0.3384	Q9	0.3207	0.3462
	0.3369	0.3451		0.3292	0.3539
	0.3373	0.3534		0.3291	0.3617
	0.3292	0.3461		0.3202	0.3535
Q5	0.3212	0.3389	QA	0.3292	0.3539
	0.3292	0.3461		0.3376	0.3616
	0.3292	0.3539		0.3379	0.3698
	0.3207	0.3462		0.3291	0.3617

Region	CIE X	CIE Y	Region	CIE X	CIE Y
P rank (6500K)					
P1	0.3068	0.3113	P6	0.3126	0.3324
	0.3145	0.3187		0.3210	0.3408
	0.3135	0.3256		0.3205	0.3481
	0.3055	0.3177		0.3117	0.3393
P2	0.3145	0.3187	P7	0.3081	0.3049
	0.3221	0.3261		0.3154	0.3119
	0.3216	0.3334		0.3145	0.3187
	0.3135	0.3256		0.3068	0.3113
P3	0.3055	0.3177	P8	0.3154	0.3119
	0.3135	0.3256		0.3226	0.3188
	0.3126	0.3324		0.3221	0.3261
	0.3041	0.3240		0.3145	0.3187
P4	0.3135	0.3256	P9	0.3028	0.3304
	0.3216	0.3334		0.3117	0.3393
	0.3210	0.3408		0.3107	0.3461
	0.3126	0.3324		0.3015	0.3368
P5	0.3041	0.3240	PA	0.3117	0.3393
	0.3126	0.3324		0.3205	0.3481
	0.3117	0.3393		0.3200	0.3554
	0.3028	0.3304		0.3107	0.3461

**Notes:** SAMSUNG ELECTRONICS maintains  $\pm 0.007$  tolerance of Cx, Cy



## 2. Characteristics

### 1) Absolute Maximum Rating

Item	Symbol	Rating	Condition
Operating temperature range	$T_{op}$	-40°C ~ +85°C	-
Storage temperature range	$T_{stg}$	-40°C ~ +120°C	-
LED junction temperature	$T_J$	110°C	-
Forward Current	$I_F$	150 mA	-
Peak Pulsed Forward Current	$I_{FP}$	300 mA	Duty 1/10 pulse width 10ms
Thermal resistance	$R_{th, j-s}$	16°C/W	Junction to solder point
Assembly Process Temperature	-	260°C, < 10sec	-
ESD	-	5kV	HBM

### 2) Electro-optical Characteristics

Item	Unit	Nominal CCT	Product Code	Rank	Min	Typ	Max		
Forward Voltage <sup>1)</sup> ( $V_F$ ) (@65 mA, $T_s = 25^\circ\text{C}$ )	V	-	-	WA	AZ	2.70	-	2.80	
				A1	2.80	-	2.90		
				A2	2.90	-	3.00		
				A3	3.00	-	3.10		
				A4	3.10	-	3.20		
Luminous Flux <sup>2)</sup> ( $\Phi_v$ ) (@65 mA, $T_s = 25^\circ\text{C}$ )	lm	2700K (W0)	*WAW0S1	S1	24.0	-	26.0		
			*WAW0S2	S2	26.0	-	28.0		
			*WAW0S3	S3	28.0	-	30.0		
		3000K (V0)	*WAV0S1	S1	24.5	-	26.5		
			*WAV0S2	S2	26.5	-	28.5		
			*WAV0S3	S3	28.5	-	30.5		
		3500K (U0)	*WAU0S1	S1	25.0	-	27.0		
			*WAU0S2	S2	27.0	-	29.0		
			*WAU0S3	S3	29.0	-	31.0		
		4000K (T0)	*WAT0S1	S1	26.0	-	28.0		
			*WAT0S2	S2	28.0	-	30.0		
			*WAT0S3	S3	30.0	-	32.0		
		5000K (R0)	*WAR0S1	S1	27.0	-	29.0		
			*WAR0S2	S2	29.0	-	31.0		
			*WAR0S3	S3	31.0	-	33.0		
		5700K (Q0)	*WAQ0S1	S1	26.5	-	28.5		
			*WAQ0S2	S2	28.5	-	30.5		
			*WAQ0S3	S3	30.5	-	32.5		
		6500K (P0)	*WAP0S1	S1	26.0	-	28.0		
			*WAP0S2	S2	28.0	-	30.0		
			*WAP0S3	S3	30.0	-	32.0		
		Reverse Voltage (@5 mA, $T_s = 25^\circ\text{C}$ )	V	-	-	-	0.7	-	1.2
		Color Rendering Index <sup>3)</sup> ( $R_a$ )	-	-	-	5	80	-	-
		Special CRI <sup>4)</sup> (R9)	-	-	-	-	0	-	-

#### Notes:

1)~4) SAMSUNG ELECTRONICS maintains a tolerance of  $V_F:\pm 0.1$  V,  $\Phi_v:\pm 5$  %,  $R_a : \pm 3.0$ ,  $R9 : \pm 6.5$  on measurements

5) " \* " is Product Code of "SPMWHT541MD5"

### 3. Typical Characteristics Graph ( $T_s = 25^\circ\text{C}$ )

#### 1) Spectrum Distribution

[CCT : 2700K & 3000K]

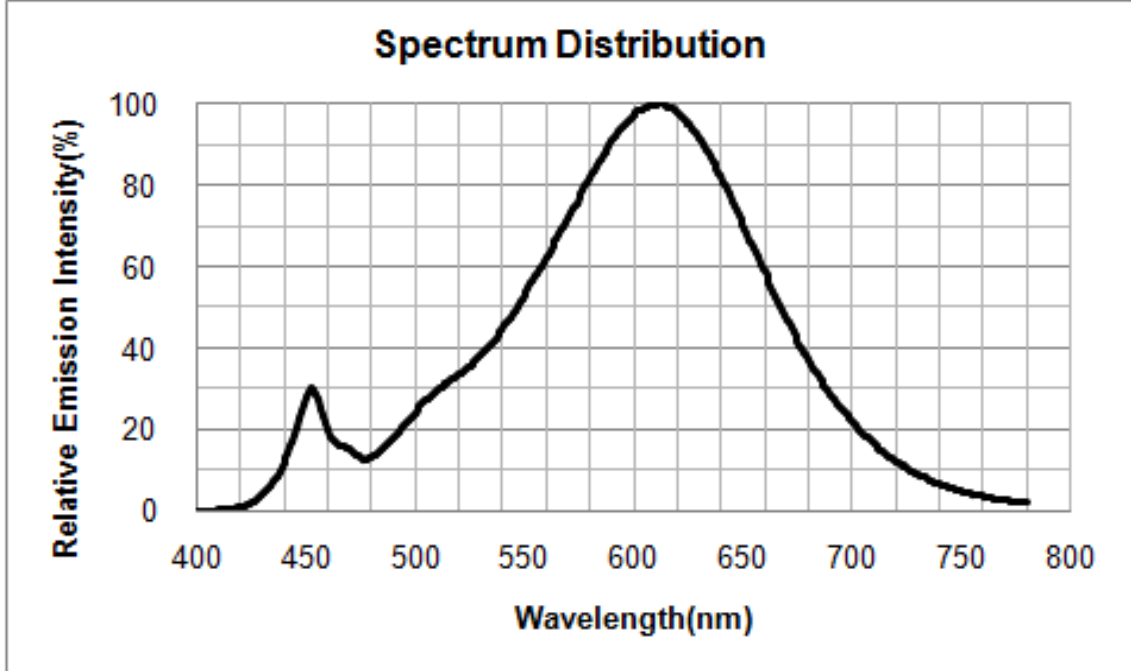

[CCT : 3500K & 4000K]

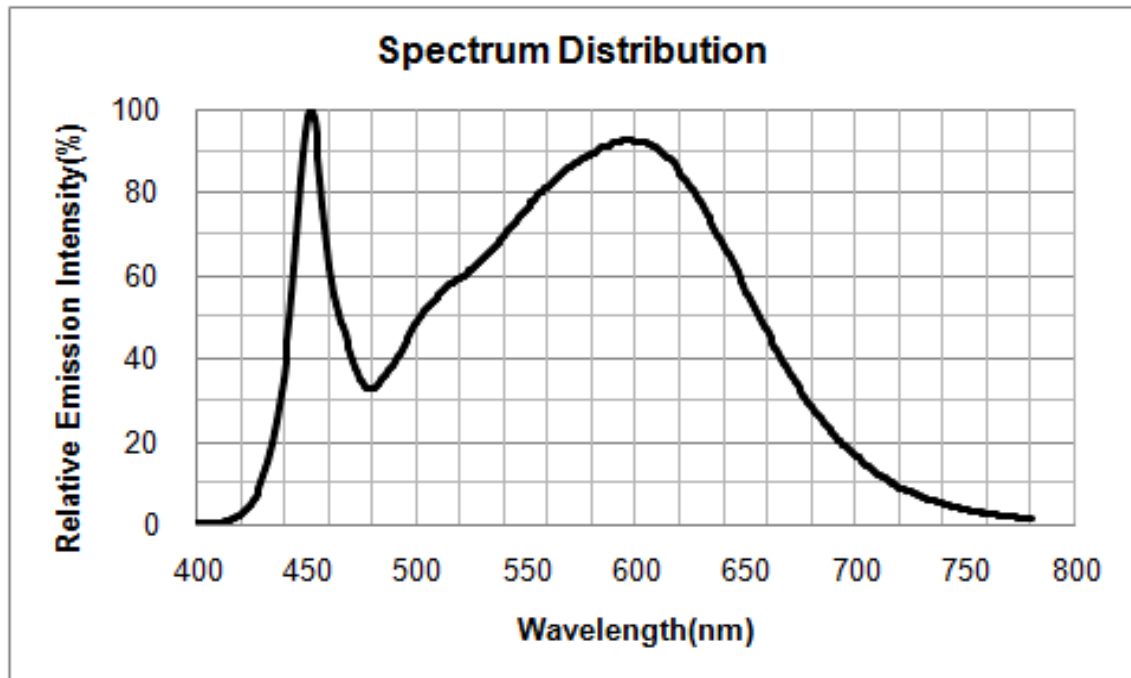

[CCT : 5000K & 5700K]

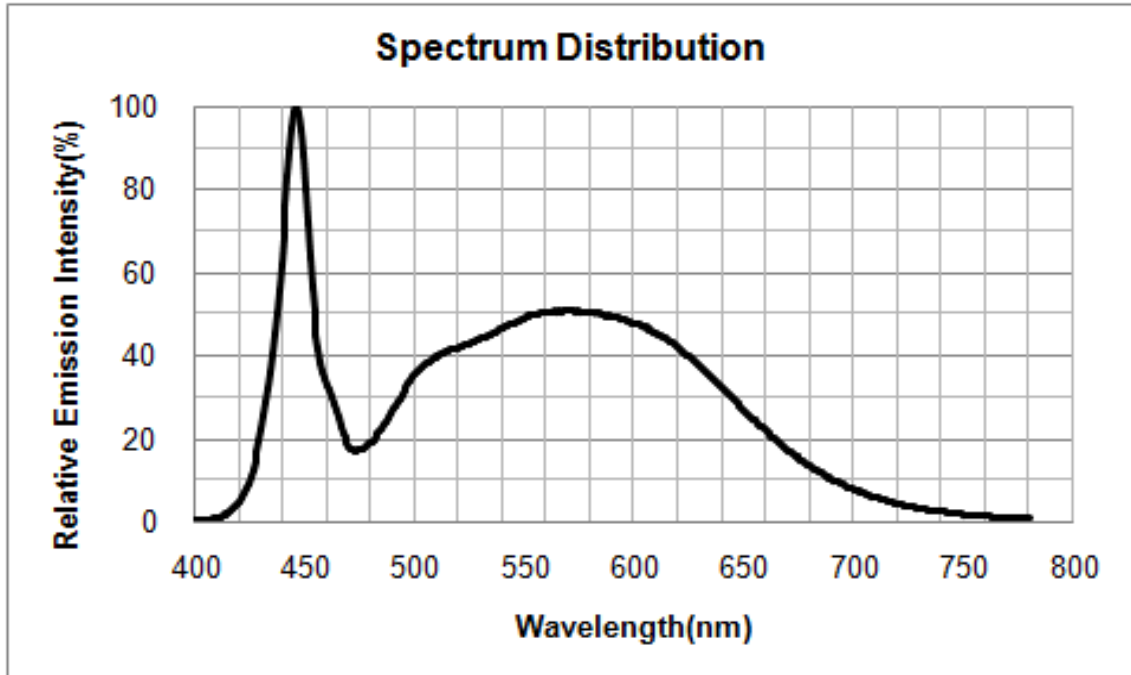

[CCT : 6500K]

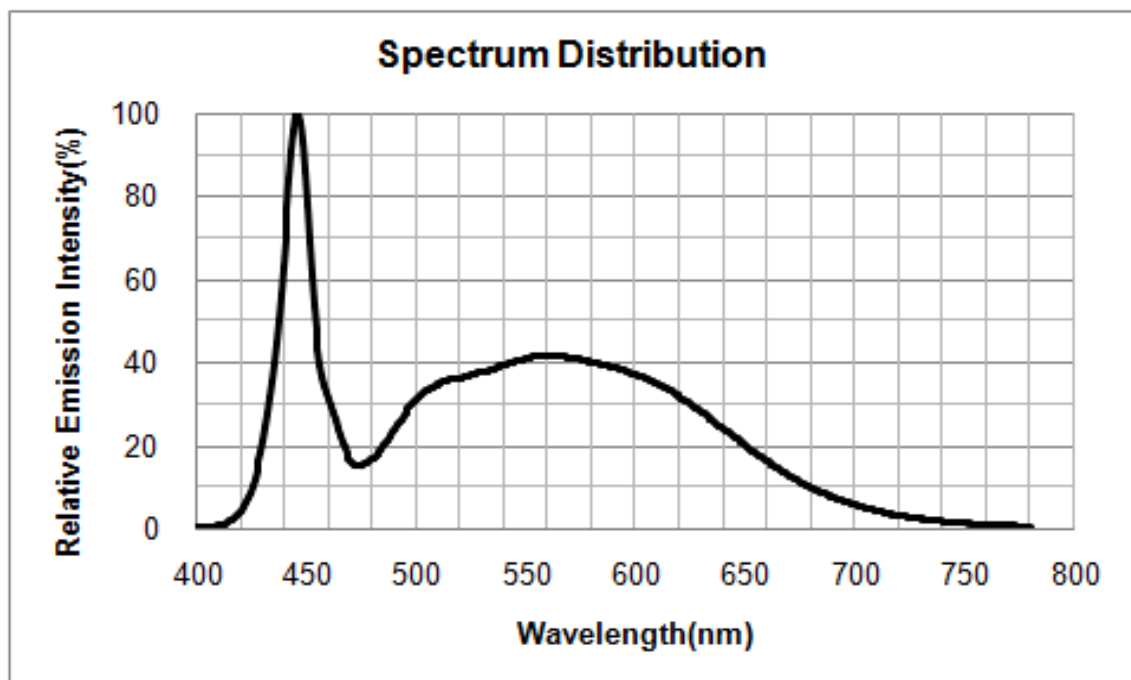

## 2) Forward Current Characteristics

[Relative Luminous Flux vs. Forward Current]

( $T_s = 25^\circ\text{C}$ )

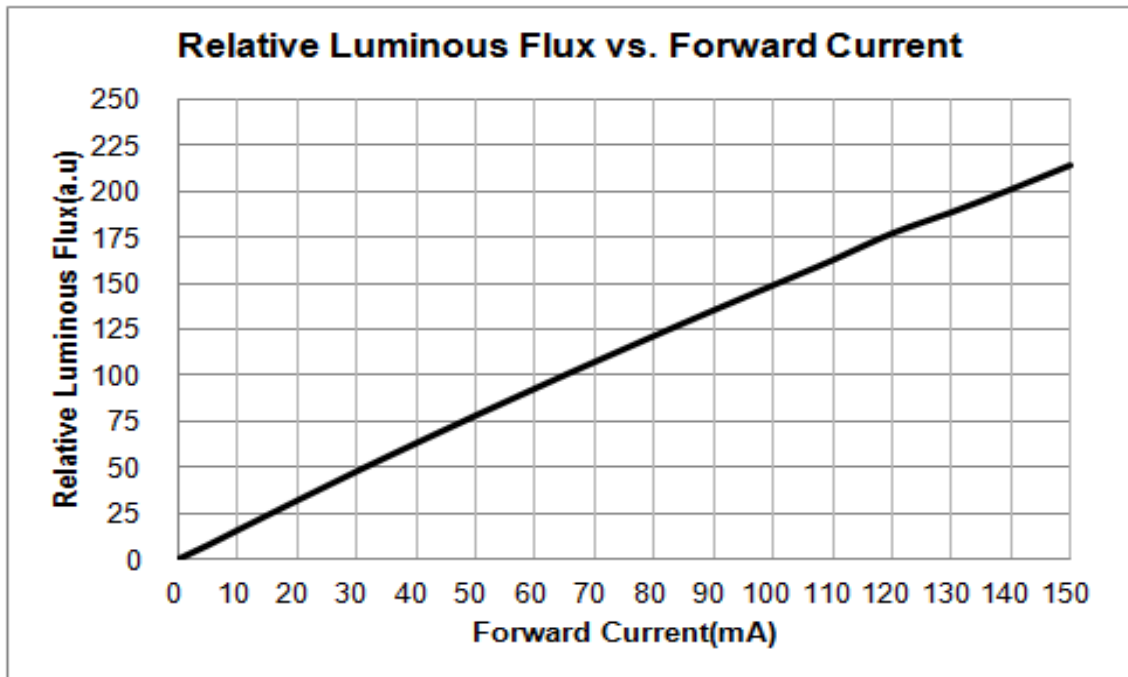

[Forward Current vs. Forward Voltage]

( $T_s = 25^\circ\text{C}$ )

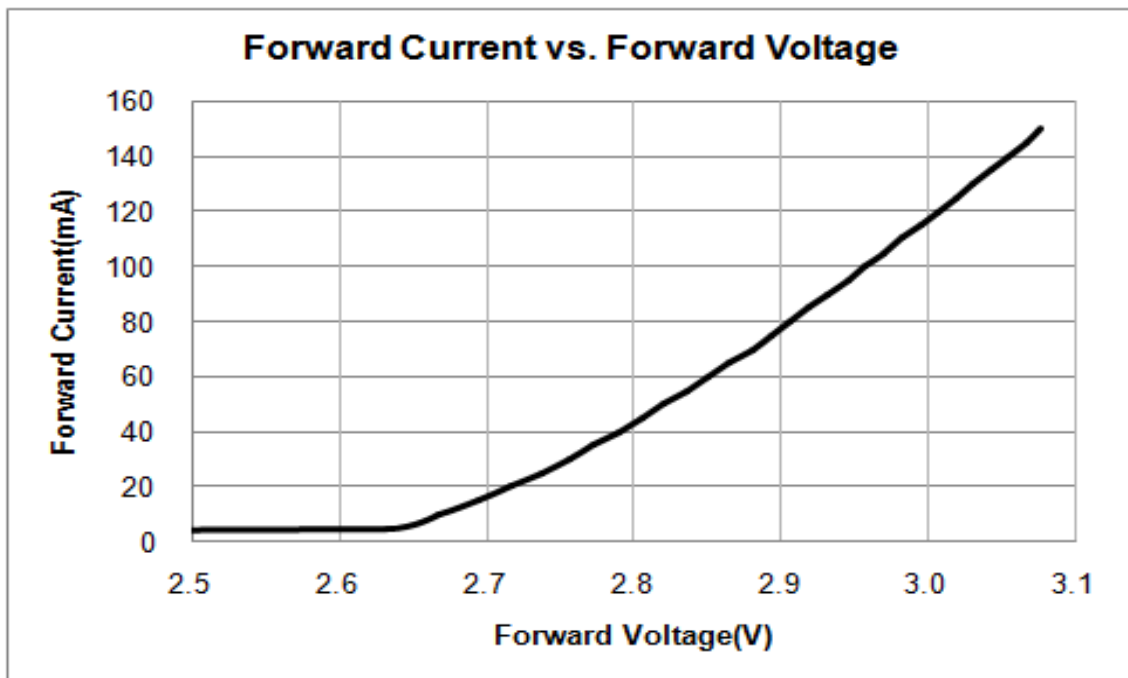

### 3) Temperature Characteristics

[Relative Luminous Flux vs.  $T_s$ ]

( $I_F = 65\text{mA}$ )

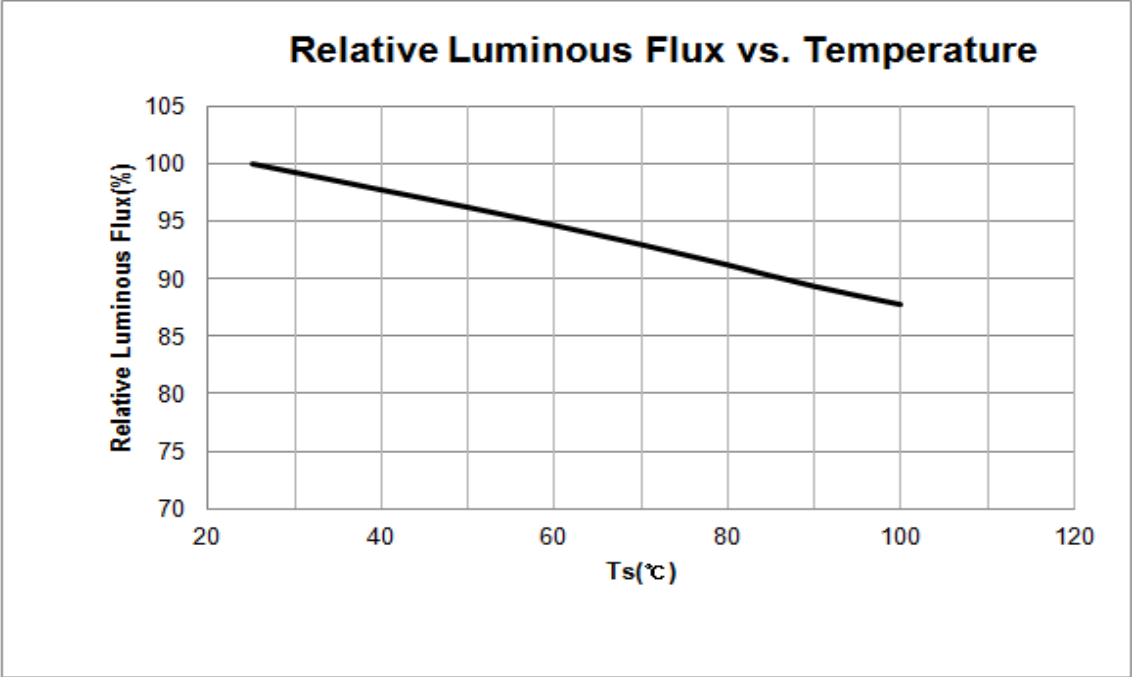

[Forward Voltage vs.  $T_s$ ]

( $I_F = 65\text{mA}$ )

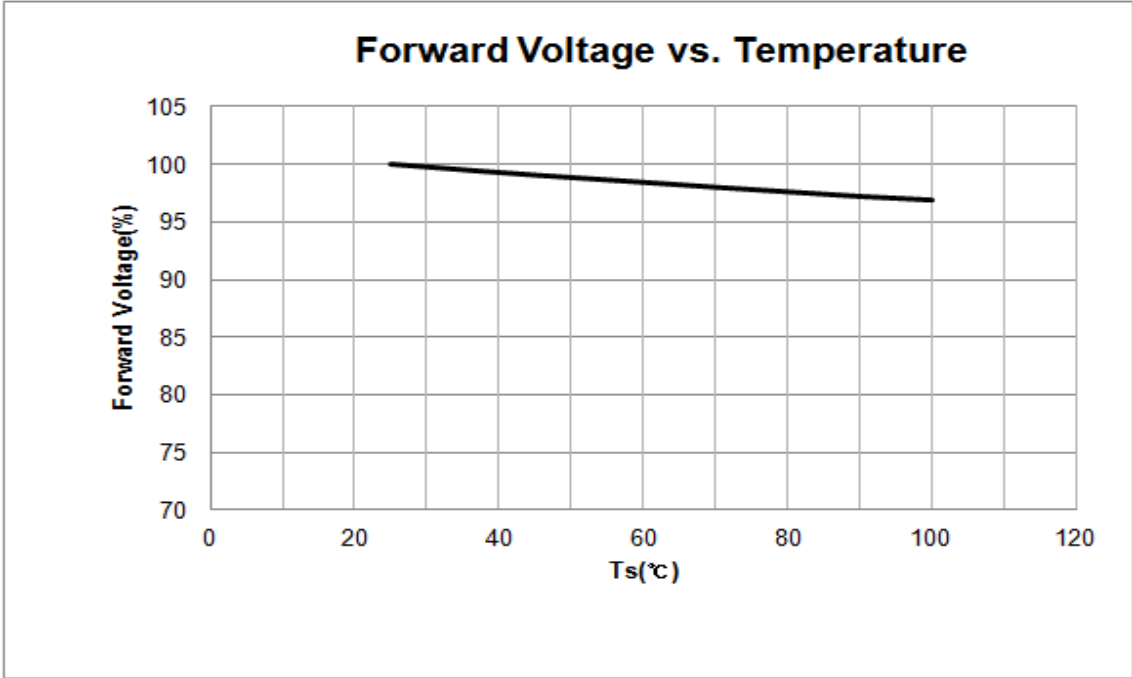

#### 4) Color shift Characteristics

[Forward Current vs. Color  $\Delta x$ ,  $\Delta y$ ]

( $T_s = 25^\circ\text{C}$ )

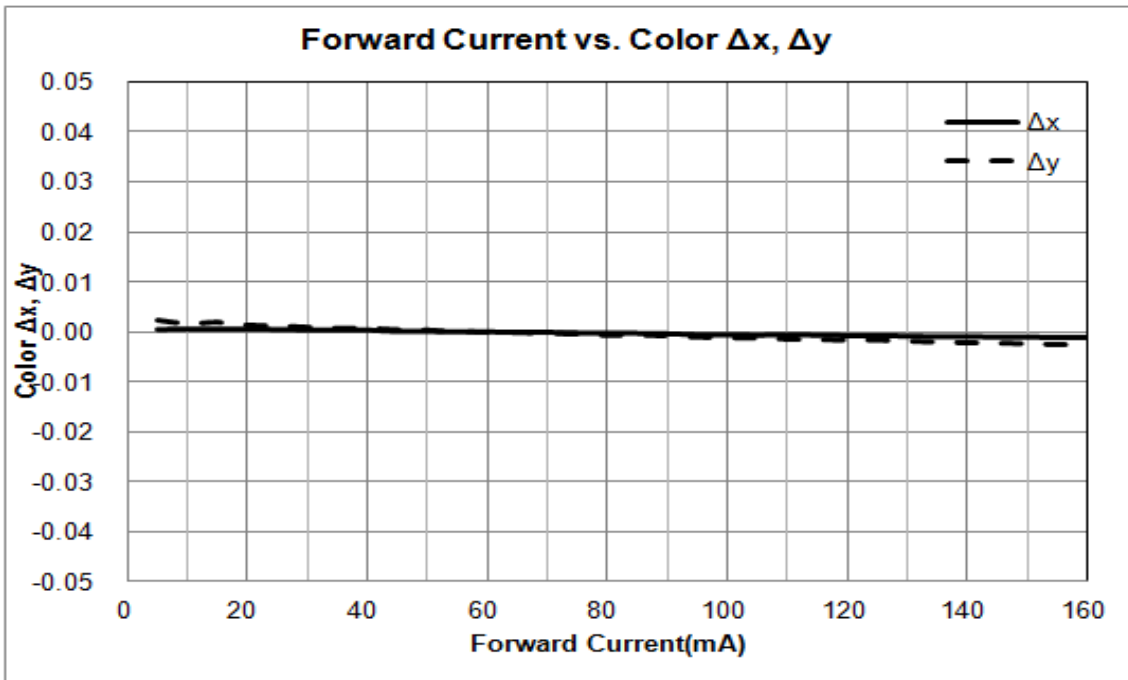

5) Derating Curve

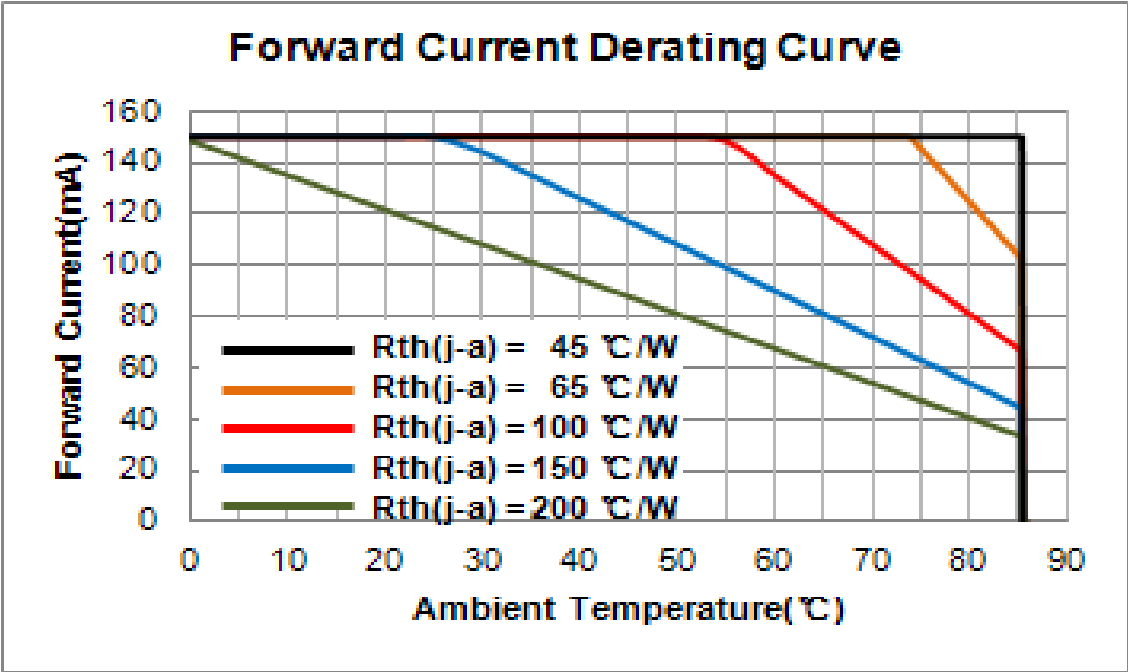

6) Beam Angle Characteristics

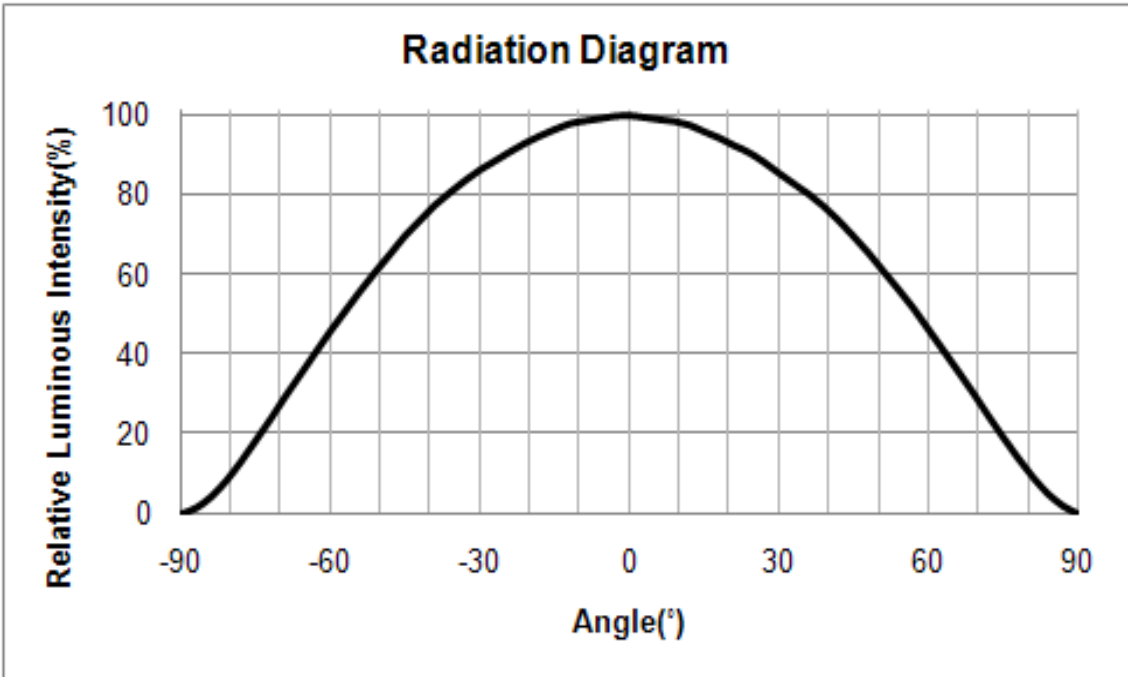

## 4. Outline Drawing & Dimension

1. Tolerance is  $\pm 0.10$  mm
2. The maximum compressing force is 15N on the body (a)
3. Do not place pressure on the encapsulation resin (b)

**Left Side View**

**Top View**

**Bottom View**

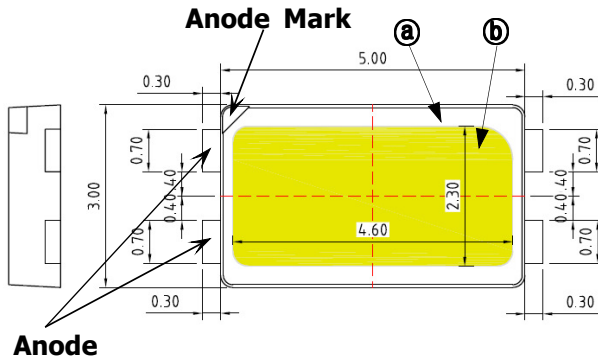

**Anode**

**Front View**

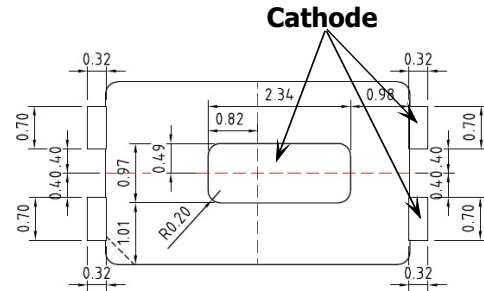
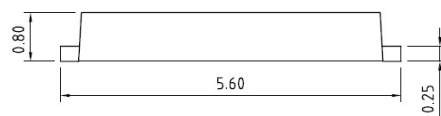

**Cathode**

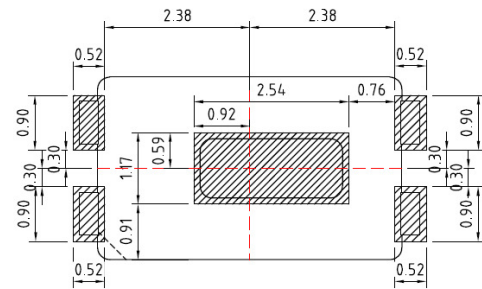

**Recommended Land Pattern**

### Notes:

- 1) This LED has built-in ESD protection device(s) connected in parallel to LED Chip(s).
- 2) Ts point & measurement method
  - ① Measure the nearest point to the thermal pad. If necessary, remove PSR of PCB to reach Ts point.
  - ② Thermal pad must be soldered to the PCB to dissipate heat properly. Otherwise, LED can be damaged.
- 3) Precautions
  - ① The pressure on the LEDs will influence to the reliability of the LEDs. Precautions should be taken to avoid the strong pressure on the LEDs. Do not put stress on the LEDs during heating.
  - ② Re-soldering should not be done after the LEDs have been soldered. If re-soldering is unavoidable, LED's characteristics should be carefully checked before and after such repair.
  - ③ Do not stack assembled PCBs together. Since materials of LEDs is soft, abrasion between two PCB assembled with LED might cause catastrophic failure of the LEDs.



## 5. Reliability Test Items and Conditions

### 1) Test Items

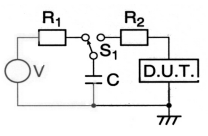
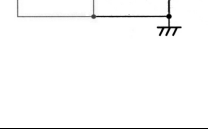
Test Item	Test Conditions	Test Hours/Cycles	Sample No	
MSL Test	125 °C 24hrs drying → 60 °C, 60 %RH 120hrs → 260 °C 10sec 3 cycles	1 cycle	11	
Room Temperature life test	25 °C±3 °C, DC150 mA	1,000 hrs	22	
High Temperature life test	85 °C±3 °C, DC150 mA	1,000 hrs	22	
High Temperature humidity life test	85 °C±3 °C, 85 %±2 %RH, DC150 mA	1,000 hrs	22	
Low Temperature life test	-40 °C±3 °C, DC150 mA	1,000 hrs	22	
Powered Temperature Cycle test	-45°C/20 min ↔ 85°C/20 min, Sweep 100min cycle on/off: each 5 min, DC 150mA	100 cycle	22	
Thermal Shock	-45 °C/15 min ↔ 125 °C/15 min → Hot plate 180 °C	500 cycle	100	
High Temperature Storage	Ta=120 °C±3 °C	1000 hrs	11	
Low Temperature Storage	Ta=-40 °C±3 °C	1000 hrs	11	
ESD(HBM)		R1:10 MΩ, R2:1.5 kΩ, C:100 pF, V = ±5 kV	5 times	5
ESD(MM)		R1:10 MΩ, R2: 0, C:200 pF, V = ±0.5 kV	5 times	5
Vibration Test	20~2000~20 Hz 200 m/s <sup>2</sup> , Sweep 4 min X, Y, Z 3 direction, each 1 cycle	4 cycles	11	
Mechanical Shock Test	1500G, 0.5 ms, 3 shocks each X-Y-Z axis	5 cycles	11	

### 2) Criteria for Judging the Damage

Item	Symbol	Test Condition	Limit	
			Min	Max
Forward Voltage	V <sub>F</sub>	I <sub>F</sub> = 65 mA	Init. Value*0.9	Init. Value*1.1
Luminous Flux	Φ <sub>v</sub>	I <sub>F</sub> = 65 mA	Init. Value*0.7	Init. Value*1.2

## 6. Solder Conditions

### 1) Reflow Conditions ( Pb Free )

Reflow Frequency : 2 times max.

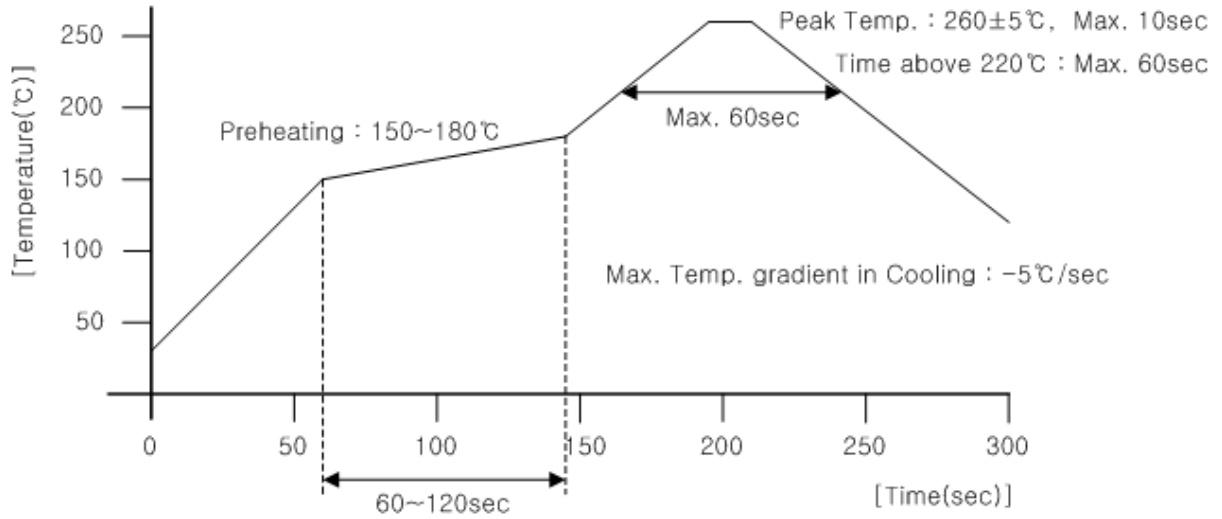

### 2) For Manual Soldering

Not more than 5 seconds @Max. 300°C, under soldering iron.

# 7. Tape & Reel

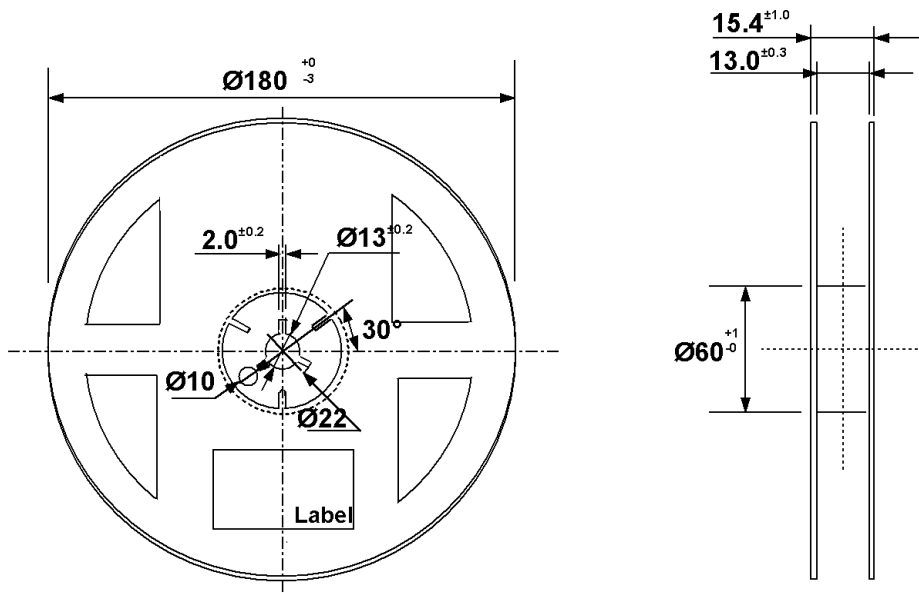
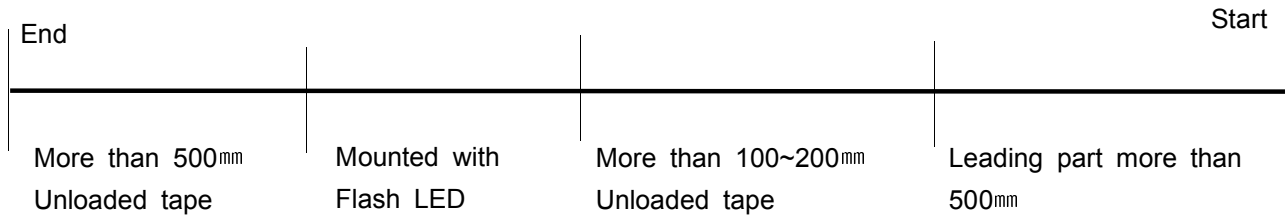
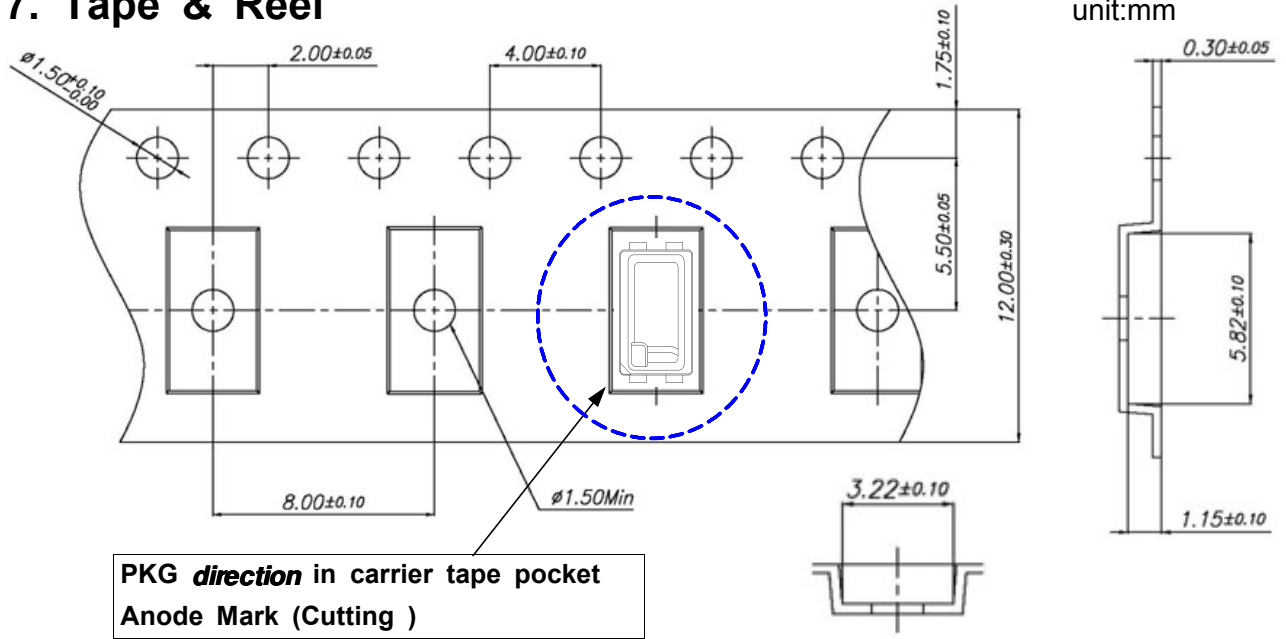

Tolerance ±0.2 , Unit:mm

- (1) Quantity : The quantity/Reel to be Max. 2,000 pcs, .
- (2) Cumulative Tolerance : Cumulative tolerance/10 pitches to be ±0.2 mm
- (3) Adhesion Strength of Cover Tape : Adhesion strength to be 0.1-0.7N when the cover tape is turned off from the carrier tape at 10°C angle to be the carrier tape.
- (4) Packaging : P/N, Manufacturing data code no. and quantity to be indicated on a damp proof Package.



## 8. Label Structure

### 1) Label Structure

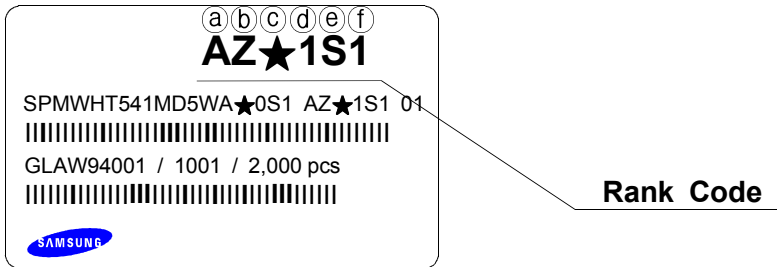

N.B) Denoted rank is the only example.

'★' means All kind of Chromaticity Coordinate Rank.

### Rank Code

- (a)(b) : Forward Voltage( $V_F$ ) Rank (refer to page. 9)
- (c)(d) : Chromaticity Coordinate Rank (refer to page. 5~8)
- (e)(f) : Luminous Flux( $\Phi_v$ , lm) Rank (refer to page. 3)

### 2) LOT Number

The Lot number is composed of the following characters

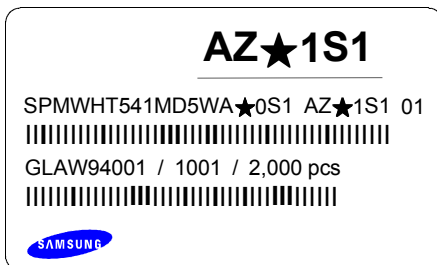

①②③④⑤⑥⑦⑧⑨ / 1(a)(b)(c) / 2,000 PCS

- ① : Production Site (S:SAMSUNG ELECTRONICS, G:GOSIN CHINA)
- ② : L (LED)
- ③ : Product State (A:Normality, B:Bulk, C:First Production, R:Reproduction, S:Sample)
- ④ : Year (V:2011, W:2012, X:2013...)
- ⑤ : Month (1 ~ 9, A, B)
- ⑥ : Day (1 ~ 9, A, B ~ V)
- ⑦⑧⑨ : SAMSUNG ELECTRONICS LED Product number (1 ~ 999)
- (a)(b)(c) : Reel Number (1 ~ 999)



# 9. Packing Structure

## 1) Packing Process

### Reel

**AZ★1S1**

SPMWHT541MD5WA★0S1 AZ★1S1 01  
 |||  
 GLAW94001 / 1001 / 2,000 pcs  
 |||

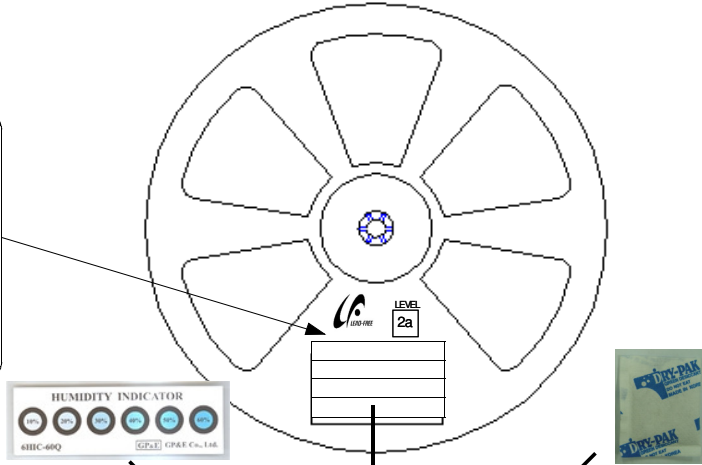

### Aluminum Vinyl Bag

**AZ★1S1**

SPMWHT541MD5WA★0S1 AZ★1S1 01  
 |||  
 GLAW94001 / 1001 / 2,000 pcs  
 |||

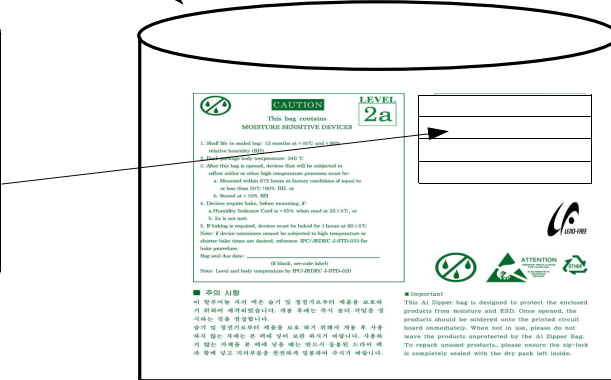

Material : Paper(SW3B(B))

TYPE	SIZE(mm)		
	L	W	H
7inch	245	220	182

### ① SIDE

**AZ★1S1**

SPMWHT541MD5WA★0S1 AZ★1S1 01  
 |||  
 GLAW94001 / 1001 / 2,000 pcs  
 |||

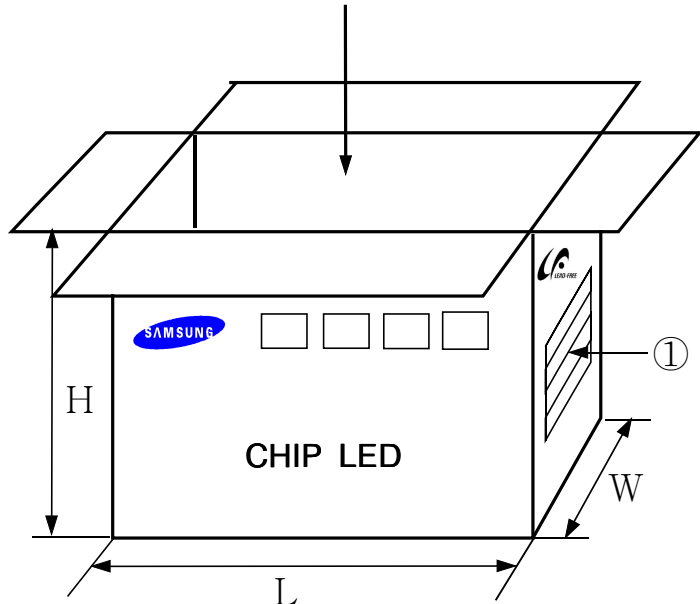

## 2) Aluminum Packing Bag

CAUTION

This bag contains  
**MOISTURE SENSITIVE DEVICES**

**LEVEL**  
**2a**

1. Shelf life in sealed bag: 12 months at <math><40^{\circ}\text{C}</math> and <math><90\%</math> relative humidity (RH)
2. Peak package body temperature: 240 °C
3. After this bag is opened, devices that will be subjected to reflow solder or other high temperature processes must be:
  - a. Mounted within 672 hours at factory conditions of equal to or less than 30°C / 60% RH, or
  - b. Stored at <math><10\%</math> RH
4. Devices require bake, before mounting, if:
  - a. Humidity Indicator Card is > 65% when read at 23±5°C, or
  - b. 2a is not met.
5. If baking is required, devices must be baked for 1 hours at 60±5°C

Note: if device containers cannot be subjected to high temperature or shorter bake times are desired, reference IPC/JEDEC J-STD-033 for bake procedure,

Bag seal due date: \_\_\_\_\_  
(if blank, see code label)

Note: Level and body temperature by IPC/JEDEC J-STD-020

### AZ★1S1

SPMWHT541MD5WA★0S1 AZ★1S1 01

GLAW94001 / 1001 / 2,000 pcs



### ■ 주의 사항

이 알루미늄 지퍼 백은 습기 및 정전기로부터 제품을 보호하기 위하여 제작되었습니다. 개봉 후에는 즉시 솔더 작업을 실시하는 것을 권장합니다.

습기 및 정전기로부터 제품을 보호 하기 위해서 개봉 후 사용하지 않는 자재는 본 팩에 넣어 보관 하시기 바랍니다. 사용하지 않는 자재를 본 팩에 넣을 때는 반드시 동봉된 드라이 팩과 함께 넣고 지퍼부분을 완전하게 밀봉하여 주시기 바랍니다.

### ■ Important

This Al Zipper bag is designed to protect the enclosed products from moisture and ESD. Once opened, the products should be soldered onto the printed circuit board immediately. When not in use, please do not leave the products unprotected by the Al Zipper Bag. To repack unused products., please ensure the zip-lock is completely sealed with the dry pack left inside.

## Silica gel & Humidity Indicator Card in Aluminum Vinyl Bag

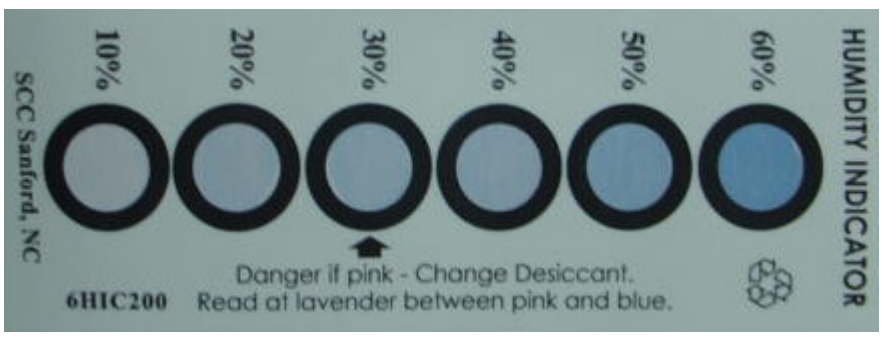

## 10. Precaution for use

- 1) For over-current-proof function, customers are recommended to apply resistors to prevent sudden change of the current caused by slight shift of the voltage.

과전류 방지를 위해 전압의 미세한 이동에 의해 야기되는 전류의 순간 변화를 방지하기 위해 저항 등의 설치를 권장함.

- 2) This device should not be used in any type of fluid such as water, oil, organic solvent, etc. When washing is required, IPA is recommended to use.

제품은 물, 오일, 유기물과 같은 액체 타입에서의 사용은 제한되며, 세정이 필요할 시에는 IPA 사용을 권장함.

- 3) When the LEDs illuminate, operating current should be decided after considering the ambient maximum temperature.

LED의 발광 시, 동작 전류는 주변 최고온도를 고려하여 결정되어야 함.

- 4) LEDs must be stored in a clean environment.

If the LEDs are to be stored for 3 months or more after being shipped from Samsung Electronics, they should be packed by a sealed container with nitrogen gas injected.(Shelf life of sealed bags: 12 months, temp. ~40°C, ~90%RH)

LED의 보관은 청정한 환경에서 보존되어야 하며, 만약 삼성전자로부터 공급받는 후 3개월 또는 그 이상 보관이 필요하다면 질소 가스를 동봉한 보존용기에 보관되어야 함. (보존 bag의 수명 : 12 개월, 보존 온도 ~40°C, 습도 ~90%RH)

- 5) After storage bag is open, device subjected to soldering, solder reflow, or other high temperature processes must be:

보존 Bag이 개봉된 후에, 납땀이나 reflow 등의 높은 온도에 노출되는 제품은 다음의 사항에 부합되어야 함.

- a. Mounted within 672 hours(28 days) at an assembly line with a condition of no more than 30°C/60%RH,

a. 제품은 30°C/60%RH보다 같거나 낮은 조립조건에서 672시간(28일)이내에 조립해야 함.

- b. Stored at <10%RH.

b. 10% 이하의 상대습도에서 보관되어야 함.

- 6) Repack unused Products with anti-moisture packing, fold to close any opening and then store in a dry place.

사용하지 않은 제품은 방습팩에 넣어 개봉 부위를 달아서 다시 포장한 후, 건조한 장소에서 보관할 것을 권장함.

7) Devices require baking before mounting, if humidity card reading is  $>60\%$  at  $23\pm 5^{\circ}\text{C}$ .  
만약 습도표시카드의 수치가  $23\pm 5^{\circ}\text{C}$ 에서  $60\%$  이상이라면, 제품 실장 전 **baking**해야 함.

8) Devices must be baked for 1 hour at  $65\pm 5^{\circ}\text{C}$ , if baking is required.  
만약 **baking**이 필요하다면, 제품은  $65\pm 5^{\circ}\text{C}$ 에서 1시간 정도 **baking** 되어야 함.

9) The LEDs are sensitive to the static electricity and surge. It is recommended to use a wrist band or anti-electrostatic glove when handling the LEDs.  
LED는 정전기 및 서지에 민감한 제품이므로, LED 제품을 다룰 시에는 정전기 방지장갑이나 손목밴드를 사용하기를 권장함.

If voltage exceeding the absolute maximum rating is applied to LEDs, it may cause damage or even destruction to LED devices.

만약 절대 허용치를 초과하는 전압이 LED에 가해지면, LED 소자는 파괴되거나 손상될 수 있음.

Damaged LEDs may show some unusual characteristics such as increase in leak current, lowered turn-on voltage, or abnormal lighting of LEDs at low current.

손상된 제품은 누설전류의 증가, Turn on 전압의 저하, 저 전류에서의 점등불량 등의 이상 거동을 보일 수 있음.

10) VOCs (volatile organic compounds) may be occurred by adhesives, flux, hardener or organic additives which is used in luminaires (fixture) and LED silicone bags are permeable to it. It may lead a discoloration when LED expose to heat or light.

VOCs(휘발성 유기 화합물)는 등기구에 사용되는 접착제, Flux, 경화제, 유기물 첨가제에서 발생하여 LED 실리콘 봉지체를 투과하고, 빛 또는 열에 노출되었을 때 변색이 발생 할 수 있음.

This phenomenon can give a significant loss of light emitted(output) from the luminaires(fixture).

이러한 현상은 등기구로부터 나오는 빛의 중대한 손실을 줄 수 있음.

In order to prevent these problems, we recommend you to know the physical properties for the materials used in luminaires, It requires to select carefully.

이러한 문제 발생 방지를 위해서, 등기구에 사용되는 자재에 대한 물성을 알고 주의하여 선택 되어야함.



### 11) Risk of Sulfurization (or Tarnishing)

The lead frame from Samsung Electronics is a plated package and it may change to black(or dark colored) when it is exposed to Ag (a), Sulfur (S), Cchlorine (Cl) or other halogen compound. It requires attention.

삼성전자의 리드 프레임은 Ag(은)을 도금한 Package 제품으로 황(S), 염소(Cl), 또는 다른 할로겐 화합물들에 노출시 Ag(은)은 검정(또는 어두운색)으로 바뀔 수 있으니 주의가 필요함.

Sulfide (Sulfurization) of the lead frame may cause a change of degradation intensity, chromaticity coordinates and it may cause open circuit in extreme cases. It requires attention.

리드 프레임의 황화(Sulfurization)는 광량 저하, 색좌표 변화 및 심한 경우 회로내의 LED 무등(Open) 불량을 일으킬 수도 있으니 주의가 필요함.

Sulfide (Sulfurization) of the lead frame may cause of storage and using with oxidizing substances together. Therefore, LED is not recommend to use and store with the below list.

: Rubber, Plain paper, lead solder cream etc.

리드 프레임 황화(Sulfurization)의 근원이 될 수 있으니 LED는 아래의 목록으로 만들어진 산화성 물질들과 함께 저장, 사용이 불가함 : 고무, 일반 종이, 납땜 크림 등



**Test Report No. F690101/LF-CTSAYAA12-42152**

Issued Date: 2012. 11. 28 Page 2 of 6

**Sample No.** : AYAA12-42152.001  
**Sample Description** : MP 5830 Gen2 Warm White  
**Item No./Part No.** : N/A  
**Materials** : N/A

**Heavy Metals**

Test Items	Unit	Test Method	MDL	Results
Cadmium (Cd)	mg/kg	With reference to IEC 62321:2008, ICP	0.5	1.34
Lead (Pb)	mg/kg	With reference to IEC 62321:2008, ICP	5	N.D.
Mercury (Hg)	mg/kg	With reference to IEC 62321:2008, ICP	2	N.D.
Hexavalent Chromium (Cr VI)	mg/kg	With reference to IEC 62321:2008, UV-VIS	1	N.D.
Antimony (Sb)	mg/kg	With reference to EPA 3052(1996), US EPA 6010B(1996), ICP	10	N.D.
Arsenic (As)	mg/kg	With reference to EPA 3052(1996), US EPA 6010B(1996), ICP	10	N.D.
Beryllium (Be)	mg/kg	With reference to EPA 3052(1996), US EPA 6010B(1996), ICP	0.5	N.D.

**Flame Retardants-PBBs/PBDEs**

Test Items	Unit	Test Method	MDL	Results
Monobromobiphenyl	mg/kg	With reference to IEC 62321:2008, GC-MS	5	N.D.
Dibromobiphenyl	mg/kg	With reference to IEC 62321:2008, GC-MS	5	N.D.
Tribromobiphenyl	mg/kg	With reference to IEC 62321:2008, GC-MS	5	N.D.
Tetrabromobiphenyl	mg/kg	With reference to IEC 62321:2008, GC-MS	5	N.D.
Pentabromobiphenyl	mg/kg	With reference to IEC 62321:2008, GC-MS	5	N.D.
Hexabromobiphenyl	mg/kg	With reference to IEC 62321:2008, GC-MS	5	N.D.
Heptabromobiphenyl	mg/kg	With reference to IEC 62321:2008, GC-MS	5	N.D.
Octabromobiphenyl	mg/kg	With reference to IEC 62321:2008, GC-MS	5	N.D.
Nonabromobiphenyl	mg/kg	With reference to IEC 62321:2008, GC-MS	5	N.D.
Decabromobiphenyl	mg/kg	With reference to IEC 62321:2008, GC-MS	5	N.D.
Monobromodiphenyl ether	mg/kg	With reference to IEC 62321:2008, GC-MS	5	N.D.
Dibromodiphenyl ether	mg/kg	With reference to IEC 62321:2008, GC-MS	5	N.D.
Tribromodiphenyl ether	mg/kg	With reference to IEC 62321:2008, GC-MS	5	N.D.
Tetrabromodiphenyl ether	mg/kg	With reference to IEC 62321:2008, GC-MS	5	N.D.
Pentabromodiphenyl ether	mg/kg	With reference to IEC 62321:2008, GC-MS	5	N.D.
Hexabromodiphenyl ether	mg/kg	With reference to IEC 62321:2008, GC-MS	5	N.D.

**NOTE:**

- (1) N.D. = Not detected.(<MDL)
- (2) mg/kg = ppm
- (3) MDL = Method Detection Limit
- (4) - = No regulation
- (5) Negative = Undetectable / Positive = Detectable
- (6) \*\* = Qualitative analysis (No Unit)
- (7) \* = Boiling-water-extraction:  
 Negative = Absence of CrVI coating  
 Positive = Presence of CrVI coating; the detected concentration in boiling-water-extraction solution is equal or greater than 0.02 mg/kg with 50 cm2 sample surface area.

This document is issued by the Company subject to its General Conditions of Service printed on back, available on request or accessible at <http://www.sgs.com/sgsweb/sgsweb.nsf>, for electronic format documents, subject to Terms and Conditions for Electronic Documents at <http://www.sgs.com/sgsweb/sgsweb.nsf/Forms/SGSForm?OpenDocument>. All rights reserved. No part of this document may be reproduced, stored in a retrieval system, or transmitted, in any form or by any means, electronic, mechanical, photocopying, recording, or by any information storage and retrieval system, without the prior written permission of SGS Korea Co., Ltd. The copyright for this document is reserved to SGS Korea Co., Ltd. All rights reserved. No part of this document may be reproduced, stored in a retrieval system, or transmitted, in any form or by any means, electronic, mechanical, photocopying, recording, or by any information storage and retrieval system, without the prior written permission of SGS Korea Co., Ltd.

SGS Korea Co., Ltd.

 322, The O valley, 555-8, Hoge-dong, Dongan-gu, Anyang-si, Gyeonggi-do, Korea 431-060  
 T +82 (0)1 4956 500 F +82 (0)1 4956 559 <http://www.sgs.com> [sgs@sgs.com](mailto:sgs@sgs.com)

F052 Version5

Member of the SGS Group (Société Générale de Surveillance)



### Test Report No. F690101/LF-CTSAYAA12-42152

Issued Date: 2012. 11. 28 Page 3 of 6

Sample No. : AYAA12-42152.001  
 Sample Description : MP 5830 Gen2 Warm White  
 Item No./Part No. : N/A  
 Materials : N/A

#### Flame Retardants-PBBs/PBDEs

Test Items	Unit	Test Method	MDL	Results
Heptabromodiphenyl ether	mg/kg	With reference to IEC 62321:2008, GC-MS	5	N.D.
Octabromodiphenyl ether	mg/kg	With reference to IEC 62321:2008, GC-MS	5	N.D.
Nonabromodiphenyl ether	mg/kg	With reference to IEC 62321:2008, GC-MS	5	N.D.
Decabromodiphenyl ether	mg/kg	With reference to IEC 62321:2008, GC-MS	5	N.D.

#### Halogen Content

Test Items	Unit	Test Method	MDL	Results
Bromine(Br)	mg/kg	BS EN 14582:2007 , IC	30	N.D.
Chlorine(Cl)	mg/kg	BS EN 14582:2007 , IC	30	N.D.
Fluorine(F)	mg/kg	BS EN 14582:2007 , IC	30	112
Iodine(I)	mg/kg	BS EN 14582:2007 , IC	50	N.D.

#### Organotin Compounds

Test Items	Unit	Test Method	MDL	Results
Monobutyltin (MBT)	mg/kg	DIN 38407-13 , GC/MS	0.1	N.D.
Dibutyltin (DBT)	mg/kg	DIN 38407-13 , GC/MS	0.1	N.D.
Tributyltin (TBT)	mg/kg	DIN 38407-13 , GC/MS	0.1	N.D.
Bis (tributyltin)oxide (TBTO)	mg/kg	DIN 38407-13 , GC/MS	0.1	N.D.
Tetrabutyltin (TeBT)	mg/kg	DIN 38407-13 , GC/MS	0.1	N.D.
Triphenyltin (TPhT)	mg/kg	DIN 38407-13 , GC/MS	0.1	N.D.
Monooctyltin(MOT)	mg/kg	DIN 38407-13 , GC/MS	0.1	N.D.
Diocetyl(DOT)	mg/kg	DIN 38407-13 , GC/MS	0.1	N.D.

#### Other(s)

Test Items	Unit	Test Method	MDL	Results
PFOS (Perfluorooctane Sulfonates-Acid/Metal Salt/Amide)	mg/kg	US EPA 3540C/3550C, LC/MS	1	N.D.

**NOTE:**

- (1) N.D. = Not detected.(<MDL)
- (2) mg/kg = ppm
- (3) MDL = Method Detection Limit
- (4) - = No regulation
- (5) Negative = Undetectable / Positive = Detectable
- (6) \*\* = Qualitative analysis (No Unit)
- (7) \* = Boiling-water-extraction:  
 Negative = Absence of CrVI coating  
 Positive = Presence of CrVI coating; the detected concentration in boiling-water-extraction solution is equal or greater than 0.02 mg/kg with 50 cm2 sample surface area.

This document is issued by the Company subject to its General Conditions of Service (posted on [www.sgslab.com](http://www.sgslab.com)) and for electronic format documents, subject to Terms and Conditions for Electronic Documents at [www.sgslab.com](http://www.sgslab.com). Neither is liable for the accuracy of the data, interpretation and/or the results shown therein. Any order or the document is not intended to be used as a contract or a guarantee of performance. The document can be reproduced or translated only with the prior written approval of the Company. Any reproduction, copying or modification of the content of this document is strictly prohibited. The document is valid for 30 days only. Unless otherwise specified, results shown in this report refer only to the samples tested and such samples are retained for 30 days only.



**Test Report No.** F690101/LF-CTSAYAA12-42152

**Issued Date:** 2012. 11. 28 **Page** 4 of 6

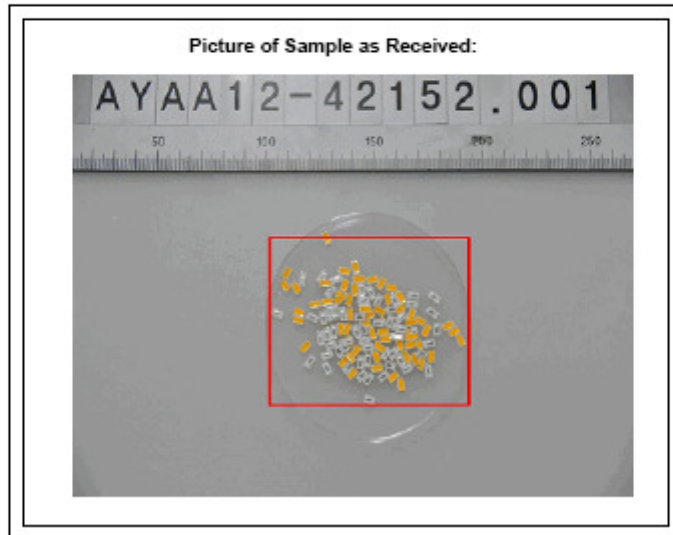

**NOTE:**

- (1) N.D. = Not detected.(<MDL)
- (2) mg/kg = ppm
- (3) MDL = Method Detection Limit
- (4) - = No regulation
- (5) Negative = Undetectable / Positive = Detectable
- (6) \*\* = Qualitative analysis (No Unit)
- (7) \* = Boiling-water-extraction:  
 Negative = Absence of CrVI coating  
 Positive = Presence of CrVI coating; the detected concentration in boiling-water-extraction solution is equal or greater than 0.02 mg/kg with 50 cm2 sample surface area.

This document is issued by the Company subject to its General Conditions of Service printed overleaf, available on request or accessible at <http://www.sgs.com/Products-and-Services/SGS> for electronic format documents, subject to Terms and Conditions for Electronic Documents at <http://www.sgs.com/Products-and-Services/SGS>. All rights reserved. Any order or the acceptance of an order by the Company shall constitute an agreement between the Company and the Client for the services only available to the Client in accordance with the General Conditions of Service. The Company's liability is limited to the extent of the actual loss suffered by the Client and shall not exceed the amount of the fee payable for the services. The Company is not responsible for any loss or damage caused by the use of the information provided in this document. The document may be reproduced or stored in any retrieval system without the prior written approval of the Company. Any unauthorised use, copying or distribution of the content of any document is strictly prohibited and offenders may be prosecuted. If you are in doubt, please contact the Company.

F052 Version5

SGS Korea Co., Ltd.

322, The O valley, 555-0, Hoge-dong, Dongan-gu, Anyang-si, Gyeonggi-do, Korea 431-060  
 t +82 (0)31 4806 000 f +82 (0)31 4806 059 <http://www.sgs.com/Products-and-Services/SGS>

Member of the SGS Group (Société Générale de Surveillance)



Test Report No. F690101/LF-CTSAYAA12-42152

Issued Date: 2012. 11. 28 Page 5 of 6

Testing Flow Chart for RoHS: Cd/Pb/Hg/Cr<sup>6+</sup> /PBBs&PBDEs Testing

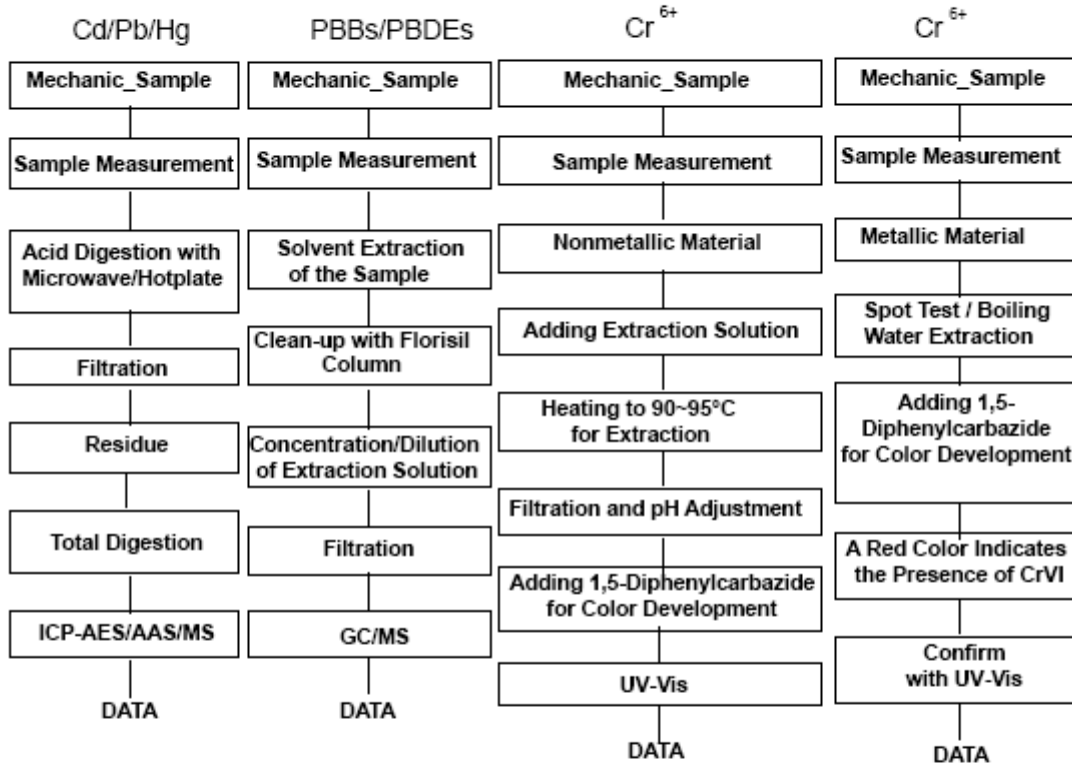

The samples were dissolved totally by pre-conditioning method according to above flow chart for Cd,Pb,Hg.  
Section Chief : Gilsae Yi

NOTE:

- (1) N.D. = Not detected.(<MDL)
- (2) mg/kg = ppm
- (3) MDL = Method Detection Limit
- (4) - = No regulation
- (5) Negative = Undetectable / Positive = Detectable
- (6) \*\* = Qualitative analysis (No Unit)
- (7) \* = Boiling-water-extraction:  
 Negative = Absence of CrVI coating  
 Positive = Presence of CrVI coating; the detected concentration in boiling-water-extraction solution is equal or greater than 0.02 mg/kg with 50 cm2 sample surface area.

This document is issued by the Company subject to its General Conditions of Service printed overleaf, available on request or accessible at <http://www.sgs.com/Products/Services/SGS%20Lab%20Services.pdf> for electronic format documents, subject to Terms and Conditions for Electronic Documents at <http://www.sgs.com/Products/Services/SGS%20Lab%20Services.pdf>. All rights reserved. Any order of this document is subject to the Company's standard terms and conditions. The Company is not responsible for the content of this document unless and otherwise may be proved in writing. The document can also be requested except in full, without prior written approval of the Company. Any reproduced document, in any form or by any means, without the prior written approval of the Company is prohibited. The document is the property of the Company. Unless otherwise stated the results shown in this test report refer only to the samples tested and such samples are retained for 90 days only.



Flow Chart for Halogen Test

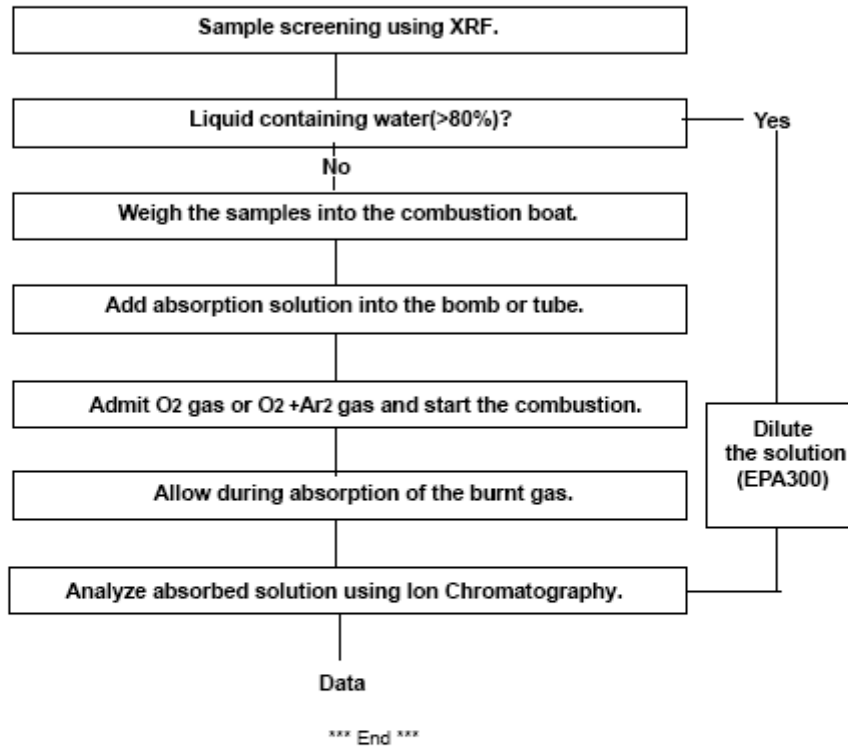

NOTE:

- (1) N.D. = Not detected.(<MDL)
- (2) mg/kg = ppm
- (3) MDL = Method Detection Limit
- (4) - = No regulation
- (5) Negative = Undetectable / Positive = Detectable
- (6) \*\* = Qualitative analysis (No Unit)
- (7) \* = Boiling-water-extraction:  
 Negative = Absence of CrVI coating  
 Positive = Presence of CrVI coating; the detected concentration in boiling-water-extraction solution is equal or greater than 0.02 mg/kg with 50 cm2 sample surface area.

This document is issued by the Company subject to its Internal Conditions of Service and/or special conditions on request or acceptance at [www.samsungled.com](http://www.samsungled.com) for electronic format documents, subject to Terms and Conditions for Electronic Documents at [www.samsungled.com/notice](http://www.samsungled.com/notice). All rights reserved. All rights reserved. Any failure of this document to be printed or displayed correctly reflects the Company's liability and is not the responsibility of the printer or the user. The Company's liability is limited to the extent of the document and does not cover any other liability arising from the use of the document. This document cannot be reproduced except in full, without the written approval of the Company. Any unauthorized alteration, copying or distribution of this document in whole or in part may be prosecuted. Documents issued on this day.

# 11. Hazard Substance Analysis - SVHC(REACH)



**Test Report No.** F690101/LF-CTSAYAA12-42151    **Issued Date:** November 30, 2012    **Page 1 of 14**

To: **SAMSUNG ELECTRONICS CO., LTD.**  
San 24, Nongseo-dong  
Giheung-gu  
Yongin-si  
Gyeonggi-do  
Korea

The following sample(s) was/were submitted and identified by/on behalf of the client as:-

---

<b>Product Name</b>	: MP 5630 Gen2 Warm White
<b>Item/Part Name</b>	: N/A
<b>SGS File No.</b>	: AYAA12-42151
<b>Received Date</b>	: November 23, 2012
<b>Test Period</b>	: November 26, 2012 ~ November 30, 2012
<b>Test Performed</b>	: SGS Korea tested the sample(s) selected by applicant with following results
<b>Test Requested</b>	: Eighty-four (84) substances in the Candidate List of Substances of Very High Concern (SVHC) for authorization published by European Chemicals Agency (ECHA) on and before June 18, 2012 regarding Regulation (EC) No 1907/2006 concerning the REACH.  Fifty-four (54) substances in the Public Consultation List of potential Substances of Very High Concern (SVHC) published by European Chemicals Agency (ECHA) on September 03, 2012 regarding Regulation (EC) No 1907/2006 concerning the REACH.
<b>Test Method</b>	: Please refer to next page(s).
<b>Test Result(s)</b>	: Please refer to next page(s).
<b>Summary</b>	: According to the specified scope and analytical technique, concentrations of all SVHC are <0.1% in the submitted sample(s).

Timothy Jeon  
Cindy park  
Jinhee Kim  
Sophia Kim  
/Testing Person

SGS Korea Co., Ltd

Jeff Jang / Chemical Lab Mgr

This document is issued by the Company subject to the General Conditions of Service printed or verbal, available on request or accessible at <http://www.sgs.com> and/or <http://www.sgs.com/sgs> and, for clients' terms documents, subject to Terms and Conditions for Electronic Documents at <http://www.sgs.com/sgs/sgs>. Attention is drawn to the disclaimer of liability, identification and jurisdiction clause defined therein. Any holder of this document is advised that it remains the property of the Company and that it is non-transferable and not to be used for any other purpose without the prior written consent of the Company. Any unauthorised alteration, forgery or falsification of the content or appearance of this document is prohibited and may be prosecuted under applicable laws. This document cannot be reproduced except in full without prior written consent of the Company. Any unauthorised alteration, forgery or falsification of the content or appearance of this document is prohibited and may be prosecuted under applicable laws. This document cannot be reproduced except in full without prior written consent of the Company.

F052 Version 5

SGS Korea Co., Ltd.

322, The Ovalley, 555-a, Hoge-dong, Dongan-gu, Anyang-si, Gyeonggi-do, Korea 431-050  
T+82 (0)21 4608 000 F+82 (0)21 4608 050 <http://www.sgslab.co.kr> [www.kr.sgs.com/sgs/sgs](http://www.kr.sgs.com/sgs/sgs)

Member of the SGS Group (Société Générale de Surveillance)





**Test Report No.** F690101/LF-CTSAYAA12-42151    **Issued Date:** November 30, 2012    **Page 2 of 14**

**Test Method:**

SGS In-House method - Analyzed by ICP-OES, PLM, UV/VIS, LC/MS ,GC/MS and colorimetric method

**Remarks:**

1. The chemical analysis of specified SVHC is performed by means of currently available analytical techniques against the following SVHC related documents published by ECHA:  
<http://echa.europa.eu/web/guest/candidate-list-table> (Candidate list)  
[http://echa.europa.eu/en/web/guest/view-article/-/journal\\_content/512b7526-9dd6-4872-934e-8c298c89ad99](http://echa.europa.eu/en/web/guest/view-article/-/journal_content/512b7526-9dd6-4872-934e-8c298c89ad99) (Potential list)  
These lists are under evaluation by ECHA and may subject to change in the future.
2. In accordance with Regulation (EC) No 1907/2006, any producer or importer of articles shall notify ECHA, in accordance with paragraph 2 of Article 7, if a substance meets the criteria in Article 57 and is identified in accordance with Article 59(1) of the Regulation, if (a) the substance is present in those articles in quantities totaling over one tonne per producer or importer per year; and (b) the substance is present in those articles above a concentration of 0.1% weight by weight (w/w).
3. Article 33 of Regulation (EC) No 1907/2006 requires supplier of an article containing a substance meeting the criteria in Article 57 and identified in accordance with Article 59(1) in a concentration above 0.1% weight by weight (w/w) shall provide the recipient of the article with sufficient information, available to the supplier, to allow safe use of the article including, as a minimum, the name of that substance in the Candidate List.
4. SGS adopts the interpretation of ECHA for SVHC in article unless indicated otherwise. Detail explanation is available at the following link:  
- [http://webstage.contribute.sgs.net/corpreach/documents/SGS-CTS\\_SVHC-paper-EN-11.pdf](http://webstage.contribute.sgs.net/corpreach/documents/SGS-CTS_SVHC-paper-EN-11.pdf)
5. Test results in this report are based on the tested sample. This report refers to testing result of composite material group by equal weight proportion. The material in each composite test group may come from one article.
6. If a SVHC is found over the reporting limit, client is suggested to identify the component which contains the SVHC and the exact concentration of the SVHC by requesting further quantitative analysis from the laboratory.

This document is issued by the Company subject to its General Conditions of Service printed on each report, available on request or accessible at [http://www.sgs.com/~/media/SGS/Service/Conditions\\_of\\_Service.pdf](http://www.sgs.com/~/media/SGS/Service/Conditions_of_Service.pdf) and its derivative forms. Documents subject to Terms and Conditions for Electronic Documents at [http://www.sgs.com/~/media/SGS/Service/Conditions\\_of\\_Service.pdf](http://www.sgs.com/~/media/SGS/Service/Conditions_of_Service.pdf). Attention is drawn to the limitation of liability, indemnification and jurisdiction clause defined herein. Any holder of this document is advised that information contained herein reflects the Company's findings at the time of its issue which may not reflect the findings of the Client's laboratory. If any. The Company's sole responsibility is to its Client and this document does not constitute advice or a guarantee from regarding all their rights and obligations under the applicable law. This document cannot be reproduced except in full without prior written consent of the Company. Any unauthorized disclosure, copying, or modification of the content or suppression of this document is subject to legal proceedings. Information is confidential. Unless otherwise stated in this test report, this report is for the use of the client only and each sample(s) are marked for 90 days only.

F052 Version 5

SGS Korea Co., Ltd.

322, The Ovalley, 555-a, Hogeje-dong, Dongan-gu, Anyang-si, Gyeonggi-do, Korea 431-050  
t +82 (0)21 4608 0000 f +82 (0)21 4608 0000 <http://www.sgslab.co.kr> [www.kr.sgs.com/greenlab](http://www.kr.sgs.com/greenlab)

Member of the SGS Group (Société Générale de Surveillance)



**Test Report No.** F690101/LF-CTSAYAA12-42151 **Issued Date:** November 30, 2012 **Page 3 of 14**

**Test Result(s)**

Substance Name	CAS number	EC number	Concentration (%)	Reporting Limit (%)	Classification
Alkanes, C10-13, chloro (Short Chain Chlorinated Paraffins)	85535-84-8	287-476-5	N.D.	0.05	PBT
Anthracene	120-12-7	204-371-1	N.D.	0.05	PBT
Benzyl butyl phthalate (BBP)	85-68-7	201-622-7	N.D.	0.05	Toxic for Reproduction
Bis(2-ethylhexyl)phthalate (DEHP)	117-81-7	204-211-0	N.D.	0.05	Toxic for Reproduction
Bis(tributyltin)oxide	56-35-9	200-268-0	N.D.	0.05	PBT
Cobalt dichloride*	7646-79-9	231-589-4	N.D.	0.005	Carcinogen Toxic for Reproduction
4,4-Diaminodiphenylmethane	101-77-9	202-974-4	N.D.	0.05	Carcinogen
Diarsenic pentaoxide*	1303-28-2	215-116-9	N.D.	0.005	Carcinogen
Diarsenic trioxide*	1327-53-3	215-481-4	N.D.	0.005	Carcinogen
Dibutyl phthalate (DBP)	84-74-2	201-557-4	N.D.	0.05	Toxic for Reproduction
Hexabromocyclododecane (HBCDD) and all major diastereoisomers identified (α-HBCDD, β-HBCDD, γ-HBCDD)	25637-99-4 and 3194-55-6 (134237-51-7, 134237-50-6, 134237-52-8)	247-148-4 and 221-695-9	N.D.	0.05	PBT
Lead hydrogen arsenate*	7784-40-9	232-064-2	N.D.	0.005	Carcinogen Toxic for Reproduction
Sodium dichromate (Sodium dichromate, dehydrate)	10588-01-9 (7789-12-0)	234-190-3	N.D.	0.005	Carcinogen Mutagen Toxic for Reproduction
5-tert-butyl-2,4,6-trinitro-m-xylene (musk xylene)	81-15-2	201-329-4	N.D.	0.05	vPvB
Triethyl arsenate*	15606-95-8	427-700-2	N.D.	0.005	Carcinogen

This document is issued by the Company subject to the General Conditions of Service printed on each available on request or accessible at <http://www.sgs.com/sgsweb/ServiceConditions.jsp> and its derivatives (hereinafter referred to as "Terms and Conditions for Electronic Documents") and the Company's liability is limited to the extent of the information and data provided herein. Any reliance on this document is at the user's sole risk. The Company is not responsible for any damage or loss of data or information caused by the use of its services and/or the use of its products. The Company's sole responsibility is to the Client and the document does not constitute advice or information from involving all their rights and obligations under their respective documents. This document cannot be reproduced except in full without the written consent of the Company. Any unauthorized copying, reuse or distribution of the content or appearance of this document is prohibited and will be deemed to be a breach of the applicable laws and regulations. If there are alterations to the results shown in this report or if you only require a partial report, an email to [sgs@sgs.com](mailto:sgs@sgs.com) is required for 30 days only.

F052 Version 5

SGS Korea Co., Ltd.

322, The Ovalley, 555-s, Hoge-dong, Dongan-gu, Anyang-si, Gyeonggi-do, Korea 431-050  
 t+82 (0)31 4508 000 f+82 (0)31 4508 000 <http://www.sgslab.co.kr> [www.kr.sgs.com/jp/en/lab](http://www.kr.sgs.com/jp/en/lab)

Member of the SGS Group (Société Générale de Surveillance)



Substance Name	CAS number	EC number	Concentration (%)	Reporting Limit (%)	Classification
Boric acid*	10043-35-3 11113-50-1	233-139-2 234-343-4	N.D.	0.005	Toxic for Reproduction
Disodium tetraborate, anhydrous*	1330-43-4 12179-04-3 1303-96-4	215-540-4	N.D.	0.005	Toxic for Reproduction
Tetraboron disodium heptaoxide, hydrate*	12267-73-1	235-541-3	N.D.	0.005	Toxic for Reproduction
Trichloroethylene	79-01-6	201-167-4	N.D.	0.05	Carcinogen
Sodium chromate*	7775-11-3	231-889-5	N.D.	0.005	Carcinogen Mutagen Toxic for Reproduction
Ammonium dichromate*	7789-09-5	232-143-1	N.D.	0.005	Carcinogen Mutagen Toxic for Reproduction
Potassium dichromate*	7778-50-9	231-906-6	N.D.	0.005	Carcinogen Mutagen Toxic for Reproduction
Potassium chromate*	7789-00-6	232-140-5	N.D.	0.005	Carcinogen Mutagen

This document is issued by the Company subject to its General Conditions of Service printed on sheet, available on request or accessible at <http://www.sgs.com/Company/Conditions.aspx> and, for clients' Personal Documents, subject to Terms and Conditions for Electronic Documents at <http://www.sgs.com/Company/Conditions.aspx>. Attention is drawn to the limitation of liability, indemnification and jurisdiction clauses defined therein. Any holder of this document is advised that electronic format does not ensure the Company's findings in the form of its information only and with the risk of data transmission. It is the Company's sole responsibility as to Client and this document does not constitute advice or a transaction. Client acknowledges that, by using this document, it is aware of its rights and obligations under the applicable documents. This document cannot be reproduced except in full, without prior written consent of the Company. Any unauthorized download, usage, or fabrication of the content or reproduction of this document is prohibited and offenders may be prosecuted to the fullest extent of the law. Unless otherwise indicated, the results shown in this test report refer only to the sample(s) tested and each sample(s) determined for 30 days only.

F052 Version 5

SGS Korea Co., Ltd.

322, The Ovalley, 555-a, Hogeje-dang, Dongan-gu, Anyang-si, Gyeonggi-do, Korea 431-050  
 t+82 (0)31 4608 000 f+82 (0)31 4608 000 <http://www.sgslab.co.kr> [www.kr.sgs.com/guestlab](http://www.kr.sgs.com/guestlab)

Member of the SGS Group (Società Générale de Surveillance)

Substance Name	CAS number	EC number	Concentration (%)	Reporting Limit (%)	Classification
Cobalt(II) sulphate*	10124-43-3	233-334-2	N.D.	0.005	Carcinogen Toxic for Reproduction
Cobalt(II) dinitrate*	10141-05-6	233-402-1	N.D.	0.005	Carcinogen Toxic for Reproduction
Cobalt(II) carbonate*	513-79-1	208-169-4	N.D.	0.005	Carcinogen Toxic for Reproduction
Cobalt(II) diacetate*	71-48-7	200-755-8	N.D.	0.005	Carcinogen Toxic for Reproduction
2-Methoxyethanol	109-86-4	203-713-7	N.D.	0.05	Toxic for Reproduction
2-Ethoxyethanol	110-80-5	203-804-1	N.D.	0.05	Toxic for Reproduction
Chromium trioxide*	1333-82-0	215-607-8	N.D.	0.005	Carcinogen Mutagen
Acids generated from chromium trioxide and their oligomers:  Chromic acid Dichromic acid  Oligomers of chromic acid and dichromic acid*	7738-94-5 13530-68-2 -	231-801-5 236-881-5 -	N.D.	0.005	Carcinogen
1-methyl-2-pyrrolidone	872-50-4	212-828-1	N.D.	0.05	Toxic for Reproduction
2-ethoxyethyl acetate	111-15-9	203-839-2	N.D.	0.05	Toxic for Reproduction
1,2-benzenedicarboxylic acid, di-C6-8-branched alkyl esters, C7-rich	71888-89-6	276-158-1	N.D.	0.05	Toxic for Reproduction
1,2-benzenedicarboxylic acid, di-C7-11-branched and linear alkyl esters	68515-42-4	271-084-6	N.D.	0.05	Toxic for Reproduction
1,2,3-trichloropropane	96-18-4	202-486-1	N.D.	0.05	Carcinogen Toxic for Reproduction
Hydrazine	7803-57-8 302-01-2	206-114-9	N.D.	0.05	Carcinogen
Strontium chromate*	7789-06-2	232-142-6	N.D.	0.005	Carcinogen

This document is issued by the Company subject to its General Conditions of Service printed on each available on request or accessible at <http://www.sgs.com/~/media/ServiceConditions.aspx> and its standard terms of service, subject to Terms and Conditions for Electronic Documents at <http://www.sgs.com/~/media/ServiceConditions.aspx>. Attention is drawn to the limitation of liability, indemnification and jurisdiction clause defined therein. Any holder of this document is advised that information contained herein reflects the Company's findings and that of its laboratories only and not the findings of Client's laboratories. It is the Client's sole responsibility to be in its Client and this document does not constitute advice or a guarantee that the results are correct. The Client is advised that the Company's findings and that of its laboratories are not intended to be used for legal or regulatory purposes. The Company is not responsible for the consequences of the use of this document or the results of the analysis. This document cannot be reproduced except in full, without prior written consent of the Company. Any unauthorized alteration, copying or distribution of this document is prohibited and offenders may be prosecuted to the fullest extent of the law. Unless otherwise stated, the results shown in this test report refer only to the sample(s) tested and each sample(s) was tested for 30 days only.

Substance Name	CAS number	EC number	Concentration (%)	Reporting Limit (%)	Classification
1,2-Dichloroethane	107-06-2	203-458-1	N.D.	0.05	Carcinogenic
2,2'-dichloro-4,4'-methylenedianiline (MOCA)	101-14-4	202-918-9	N.D.	0.05	Carcinogenic
2-Methoxyaniline o-Anisidine	90-04-0	201-963-1	N.D.	0.05	Carcinogenic
4-(1,1,3,3-tetramethylbutyl)phenol, (4-tert-Octylphenol)	140-66-9	205-426-2	N.D.	0.05	Equivalent level of concern having probable serious effects to the environment
Aluminosilicate Refractory Ceramic Fibres* (RCF)	650-017-00-8 (Index no.)	-	N.D.	0.005	Carcinogenic
Arsenic acid*	7778-39-4	231-901-9	N.D.	0.005	Carcinogenic
Bis(2-methoxyethyl) ether	111-96-6	203-924-4	N.D.	0.05	Toxic for reproduction
Bis(2-methoxyethyl) phthalate	117-82-8	204-212-6-	N.D.	0.05	Toxic for reproduction
Calcium arsenate*	7778-44-1	231-904-5	N.D.	0.005	Carcinogenic
Dichromium tris(chromate)*	24613-89-6	246-356-2	N.D.	0.005	Carcinogenic
Formaldehyde, oligomeric reaction products with aniline (technical MDA)	25214-70-4	500-036-1	N.D.	0.05	Carcinogenic
Lead diazide*	13424-46-9	236-542-1	N.D.	0.005	Toxic for reproduction
Lead dipicrate*	6477-64-1	229-335-2	N.D.	0.005	Toxic for reproduction
Lead styphnate*	15245-44-0	239-290-2	N.D.	0.005	Toxic for reproduction
N,N-dimethylacetamide (DMAC)	127-19-5	204-826-4	N.D.	0.05	Toxic for reproduction
Pentazinc chromate octahydroxide*	49663-84-5	256-418-0	N.D.	0.005	Carcinogenic
Phenolphthalein	77-09-8	201-004-7	N.D.	0.05	Carcinogenic
Potassium hydroxyoctaoxidincatedichromate*	11103-86-9	234-329-8	N.D.	0.005	Carcinogenic
Trilead diarsenate*	3687-31-8	222-979-5	N.D.	0.005	Carcinogenic Toxic for reproduction
Zirconia Aluminosilicate Refractory Ceramic Fibres (Zr-RCF)*	650-017-00-8 (Index no.)	-	N.D.	0.005	Carcinogenic

This document is issued by the Company subject to its General Conditions of Service printed on sheet, available on request or accessible at <http://www.sgs.com/ServiceConditions.aspx> and, for documents issued electronically, subject to Terms and Conditions for Electronic Documents at <http://www.sgs.com/ServiceConditions.aspx>. Attention is drawn to the limitation of liability, indemnification and jurisdiction clause defined therein. Any holder of this document is advised that information contained herein reflects the Company's findings at the time of its issuance only and will be obsolete if there is any change in the Company's data. The Company's sole responsibility is to the Client and this document does not constitute advice or recommendation from any other party. All rights and obligations under this document are reserved. This document cannot be reproduced, stored in a retrieval system or transmitted in any form or by any means, electronic, mechanical, photocopying, recording, or otherwise, without the prior written consent of the Company. Any use of this document, in whole or in part, without the prior written consent of the Company is prohibited. All rights reserved. All trademarks are the property of their respective owners.

F052 Version 5

SGS Korea Co., Ltd.

322, The Ovalley, 555-a, Hoge-dong, Dongan-gu, Anyang-si, Gyeonggi-do, Korea 431-050  
t:+82 (0)31 4608 000 f:+82 (0)31 4608 000 <http://www.sgslab.co.kr> [www.kr.sgs.com/guestlab](http://www.kr.sgs.com/guestlab)

Member of the SGS Group (Société Générale de Surveillance)

Substance Name	CAS number	EC number	Concentration (%)	Reporting Limit (%)	Classification
1,2-bis(2-methoxyethoxy)ethane (TEGDME; triglyme)	112-49-2	203-977-3	N.D.	0.05	Toxic for reproduction
1,2-dimethoxyethane;ethylene glycol dimethyl ether (EGDME)	110-71-4	203-794-9	N.D.	0.05	Toxic for reproduction
Diboron trioxide*	1303-86-2	215-125-8	N.D.	0.005	Toxic for reproduction
Formamide	75-12-7	200-842-0	N.D.	0.05	Toxic for reproduction
Lead(II) bis(methanesulfonate)*	17570-76-2	401-750-5	N.D.	0.005	Toxic for reproduction
TGIC(1,3,5-tris(oxiranylmethyl)-1,3,5-triazine-2,4,6-(1H,3H,5H)-trione)	2451-62-9	219-514-3	N.D.	0.05	Mutagenic
$\beta$ -TGIC (1,3,5-tris[(2S and 2R)-2,3-epoxypropyl]-1,3,5-triazine-2,4,6-(1H,3H,5H)-trione)**	59653-74-6	423-400-0	N.D.	0.05	Mutagenic
4,4'-bis(dimethylamino)benzophenone (Michler's ketone)	90-94-8	202-027-5	N.D.	0.05	Carcinogenic
N,N,N',N'-tetramethyl-4,4'-methylenedianiline (Michler's base)	101-61-1	202-959-2	N.D.	0.05	Carcinogenic
[4-[4,4'-bis(dimethylamino)benzhydrylidene]cyclohexa-2,5-dien-1-ylidene]dimethylammonium chloride (C.I. Basic Violet 3)	548-62-9	208-953-6	N.D.	0.05	Carcinogenic
[4-[[4-anilino-1-naphthyl][4-(dimethylamino)phenyl]methylene]cyclohexa-2,5-dien-1-ylidene]dimethylammonium chloride (C.I. Basic Blue 26)	2580-56-5	219-943-6	N.D.	0.05	Carcinogenic
$\alpha,\alpha$ -Bis[4-(dimethylamino)phenyl]-4(phenylamino)naphthalene-1-methanol (C.I. Solvent Blue 4)	6786-83-0	229-851-8	N.D.	0.05	Carcinogenic
4,4'-bis(dimethylamino)-4''-(methylamino)trityl alcohol	561-41-1	209-218-2	N.D.	0.05	Carcinogenic

This document is issued by the Company subject to the General Conditions of Service printed on each, available on request or accessible at <http://www.sgs.com/sgs/CompanyConditions.aspx> and its derivatives forms documents subject to Terms and Conditions for Electronic Documents at <http://www.sgs.com/sgs/eDocuments.aspx>. Attention is drawn to the limitation of liability, indemnification and jurisdiction laws defined therein. Any holder of this document is advised that information contained herein reflects the Company's findings at the time of its issue unless otherwise indicated or otherwise stated. The Company's sole responsibility is to the Client and this document does not constitute advice or a guarantee from regarding all the rights and obligations under the applicable law. This document cannot be reproduced except in full without prior written approval of the Company. Any reproduction of copies, images or illustrations of the content or appearance of this document is prohibited and if detected may be prosecuted. Information contained herein is for reference only. The results shown in this test report may only be used for the specific material and such samples are retained for 90 days only.

F052 Version 5

SGS Korea Co., Ltd.

322, The Ovalley, 555-a, Hageye-dong, Dongan-gu, Anyang-si, Gyeonggi-do, Korea 431-050  
t+82 (0)31 4609 000 f+82 (0)31 4609 000 <http://www.sgsbb.co.kr> [www.kr.sgs.com/greenlab](http://www.kr.sgs.com/greenlab)

Member of the SGS Group (Société Générale de Surveillance)



**Test Report No.** F690101/LF-CTSAYAA12-42151 **Issued Date:** November 30, 2012 **Page 9 of 14**

**The potential Substances**

Substance Name	CAS number	EC number	Concentration (%)	Reporting Limit (%)	Classification
Bis(pentabromophenyl) ether (DecaBDE)	1163-19-5	214-604-9	N.D.	0.05	PBT vPvB
Pentacosfluorotridecanoic acid	72629-94-8	276-745-2	N.D.	0.05	vPvB
Tricosfluorododecanoic acid	307-55-1	206-203-2	N.D.	0.05	vPvB
Henicosfluoroundecanoic acid	2058-94-8	218-165-4	N.D.	0.05	vPvB
Heptacosfluorotetradecanoic acid	376-06-7	206-803-4	N.D.	0.05	vPvB
4-(1,1,3,3-tetramethylbutyl)phenol, ethoxylated - covering well-defined substances and UVCB substances, polymers and homologues	-	-	N.D.	0.05	Equivalent level of concern - probable serious effects on the environment
4-Nonylphenol, branched and linear - substances with a linear and/or branched alkyl chain with a carbon number of 9 covalently bound in position 4 to phenol, covering also UVCB- and well-defined substances which include any of the individual isomers or a combination thereof	-	-	N.D.	0.05	Equivalent level of concern - probable serious effects on the environment
Diazeno-1,2-dicarboxamide (C,C'-azodi(formamide))	123-77-3	204-650-8	N.D.	0.05	Equivalent level of concern - probable serious effects on human health
Cyclohexane-1,2-dicarboxylic anhydride (Hexahydrophthalic anhydride - HHPA)	85-42-7	201-604-9	N.D.	0.05	Equivalent level of concern - probable serious effects on human health

This document is issued by the Company subject to its General Conditions of Service printed on each analytical report or request or available at <http://www.sgs.com> and for clients' internal use only. It is intended for the client's internal use only. The Company's sole responsibility is to its Client and this document does not constitute an offer of any service or product. The Company's liability is limited to the extent of the contract. This document cannot be reproduced without the written consent of the Company. Any unauthorized alteration, copying or distribution of this document is prohibited and offenders may be prosecuted to the full extent of the law. Other alterations of this report shall be the responsibility of the client and each sample(s) are marked for ID (see page 10).

F052 Version 5

SGS Korea Co., Ltd.

322, The Ovalley, 555-s, Hoge-dong, Dongan-gu, Anyang-si, Gyeonggi-do, Korea 431-050  
 t+82 (0)31 4608 000 f+82 (0)31 4608 000 <http://www.sgslab.co.kr> [www.kr.sgs.com](http://www.kr.sgs.com) [gs@sgs.com](mailto:gs@sgs.com)

Member of the SGS Group (Société Générale de Surveillance)



Substance Name	CAS number	EC number	Concentration (%)	Reporting Limit (%)	Classification
Hexahydromethylphthalic anhydride, Hexahydro-4-methylphthalic anhydride, Hexahydro-1-methylphthalic anhydride, Hexahydro-3-methylphthalic anhydride	25550-51-0, 19438-60-9, 48122-14-1, 57110-29-9	247-094-1, 243-072-0, 256-356-4, 260-566-1	N.D.	0.05	Equivalent level of concern - probable serious effects on human health
Methoxy acetic acid	625-45-6	210-894-6	N.D.	0.05	Toxic for reproduction equivalent level of concern - probable serious effects on human health and the environment
1,2-Benzenedicarboxylic acid, dipentylester, branched and linear	84777-06-0	284-032-2	N.D.	0.05	Toxic for reproduction
Diisopentylphthalate (DIPP)	605-50-5	210-088-4	N.D.	0.05	Toxic for reproduction
N-pentyl-isopentylphthalate	-	-	N.D.	0.05	Toxic for reproduction
1,2-Diethoxyethane	629-14-1	211-076-1	N.D.	0.05	Toxic for reproduction
N,N-dimethylformamide; dimethyl formamide	68-12-2	200-679-5	N.D.	0.05	Toxic for reproduction
Dibutyltin dichloride (DBT)	683-18-1	211-670-0	N.D.	0.05	Toxic for reproduction
Acetic acid, lead salt, basic*	51404-69-4	257-175-3	N.D.	0.005	Toxic for reproduction
Basic lead carbonate (trilead bis(carbonate)dihydroxide)*	1319-46-6	215-290-6	N.D.	0.005	Toxic for reproduction
Lead oxide sulfate (basic lead sulfate)*	12036-76-9	234-853-7	N.D.	0.005	Toxic for reproduction
[Phthalato(2-)]dioxotrilead (dibasic lead phthalate)*	69011-06-9	273-688-5	N.D.	0.005	Toxic for reproduction

This document is issued by the Company subject to the General Conditions of Service printed on each available on request or accessible at <http://www.sgs.com/ServiceConditions.aspx> and, for electronic format documents, subject to Terms and Conditions for Electronic Documents at <http://www.sgs.com/ServiceConditions.aspx>. Attention is drawn to the limitation of liability, indemnification and jurisdiction clause defined therein. Any holder of this document is advised that information contained herein reflects the Company's findings within the limit of its internal quality and safety policies of Client's responsibility. If any. The Company's sole responsibility is to the Client and this document does not constitute advice or a guarantee from regarding all their rights and obligations under the transaction document. This document cannot be reproduced, stored in a retrieval system, or transmitted, in any form or by any means, electronic, mechanical, photocopying, recording, or otherwise, without prior written permission of the Company. Any unauthorized disclosure, copying, or modification of the content or appearance of this document is prohibited and offenders may be prosecuted to the fullest extent of the law. Unless otherwise stated, the results shown in this test report refer only to the sample(s) tested and each sample(s) are marked for 90 days only.

F052 Version 5

SGS Korea Co., Ltd.

322, The Ovalley, 555-a, Hogeje-dong, Dongan-gu, Anyang-si, Gyeonggi-do, Korea 431-050  
 t+82 (0)31 4608 900 f+82 (0)31 4608 999 <http://www.sgslab.co.kr> [www.kr.sgs.com](http://www.kr.sgs.com) [www.kr.sgs.com/guestlab](http://www.kr.sgs.com/guestlab)

Member of the SGS Group (Société Générale de Surveillance)

Substance Name	CAS number	EC number	Concentration (%)	Reporting Limit (%)	Classification
Dioxobis(stearato)trilead*	12578-12-0	235-702-8	N.D.	0.005	Toxic for reproduction
Fatty acids, C16-18, lead salts*	91031-62-8	292-966-7	N.D.	0.005	Toxic for reproduction
Lead bis(tetrafluoroborate)*	13814-96-5	237-486-0	N.D.	0.005	Toxic for reproduction
Lead cyanamidate*	20837-86-9	244-073-9	N.D.	0.005	Toxic for reproduction
Lead dinitrate*	10099-74-8	233-245-9	N.D.	0.005	Toxic for reproduction
Lead oxide (lead monoxide)*	1317-36-8	215-267-0	N.D.	0.005	Toxic for reproduction
Lead tetroxide (orange lead)*	1314-41-6	215-235-6	N.D.	0.005	Toxic for reproduction
Lead titanium trioxide*	12060-00-3	235-038-9	N.D.	0.005	Toxic for reproduction
Lead Titanium Zirconium Oxide*	12626-81-2	235-727-4	N.D.	0.005	Toxic for reproduction
Pentalead tetraoxide sulphate*	12065-90-6	235-067-7	N.D.	0.005	Toxic for reproduction
Pyrochlore, antimony lead yellow*	8012-00-8	232-382-1	N.D.	0.005	Toxic for reproduction
Silicic acid, barium salt, lead-doped*	68784-75-8	272-271-5	N.D.	0.005	Toxic for reproduction
Silicic acid, lead salt*	11120-22-2	234-363-3	N.D.	0.005	Toxic for reproduction
Sulfurous acid, lead salt, dibasic*	62229-08-7	263-467-1	N.D.	0.005	Toxic for reproduction
Tetraethyllead*	78-00-2	201-075-4	N.D.	0.005	Toxic for reproduction
Tetralead trioxide sulphate*	12202-17-4	235-380-9	N.D.	0.005	Toxic for reproduction

This document is issued by the Company subject to its General Conditions of Service printed on sheet, available on request or accessible at <http://www.sgs.com/ServiceConditions.aspx> and, for electronic format documents, subject to Terms and Conditions for Electronic Documents at <http://www.sgs.com/ServiceConditions.aspx>. Attention is drawn to the limitation of liability, to identification and justification requirements defined therein. Any fault or omission in this document is considered the client's responsibility unless the Company's findings at the time of its intervention only and without the knowledge of Client's intervention. If any of the Company's tests are performed on a sample that is not representative of the entire batch, the Company's findings are only valid for the sample tested. This document cannot be reproduced or transmitted in any form or by any means, electronic, mechanical, photocopying, recording, or otherwise, without the prior written permission of the Company. Any unauthorized disclosure, copying, or distribution of the contents or suppression of this document is subject to a fine and/or imprisonment in accordance with applicable laws.

F052 Version 5

SGS Korea Co., Ltd.

322, The Ovalley, 555-a, Hyeje-dong, Dongan-gu, Anyang-si, Gyeonggi-do, Korea 431-050  
t:+82 (0)31 4608 000 f:+82 (0)31 4608 000 <http://www.sgs.com> [www.kr.sgs.com](http://www.kr.sgs.com) [www.gseintab.com](http://www.gseintab.com)

Member of the SGS Group (Societas G6nditae de Surveillance)

Substance Name	CAS number	EC number	Concentration (%)	Reporting Limit (%)	Classification
Trilead dioxide phosphonate*	12141-20-7	235-252-2	N.D.	0.005	Toxic for reproduction
Furan	110-00-9	203-727-3	N.D.	0.05	Carcinogenic
Propylene oxide; 1,2-epoxypropane; methyloxirane	75-56-9	200-879-2	N.D.	0.05	Carcinogenic Mutagenic
Diethyl sulphate	64-67-5	200-589-6	N.D.	0.05	Carcinogenic Mutagenic
Dimethyl sulphate	77-78-1	201-058-1	N.D.	0.05	Carcinogenic
3-ethyl-2-methyl-2-(3-methylbutyl)-1,3-oxazolidine	143860-04-2	421-150-7	N.D.	0.05	Toxic for reproduction
Dinoseb	88-85-7	201-861-7	N.D.	0.05	Toxic for reproduction
4,4'-methylenedi-o-toluidine	838-88-0	212-658-8	N.D.	0.05	Carcinogenic
4,4'-oxydianiline and its salts	101-80-4	202-977-0	N.D.	0.05	Carcinogenic Mutagenic
4-Aminoazobenzene; 4-Phenylazoaniline	60-09-3	200-453-6	N.D.	0.05	Carcinogenic
4-methyl-m-phenylenediamine (2,4-toluene-diamine)	95-80-7	202-453-1	N.D.	0.05	Carcinogenic
6-methoxy-m-toluidine (p-cresidine)	120-71-8	204-419-1	N.D.	0.05	Carcinogenic
Biphenyl-4-ylamine	92-67-1	202-177-1	N.D.	0.05	Carcinogenic
o-aminoazotoluene	97-56-3	202-591-2	N.D.	0.05	Carcinogenic
o-Toluidine; 2-Aminotoluene	95-53-4	202-429-0	N.D.	0.05	Carcinogenic
N-methylacetamide	79-16-3	201-182-6	N.D.	0.05	Toxic for reproduction
1-bromopropane; n-propyl bromide	106-94-5	203-445-0	N.D.	0.05	Toxic for reproduction

This document is issued by the Company subject to its General Conditions of Service printed on request, available on request or accessible at <http://www.sgs.com/ServiceConditions.aspx> and, for electronic format documents, subject to Terms and Conditions for Electronic Documents at <http://www.sgs.com/ServiceConditions.aspx>. Attention is drawn to the limitation of liability, indemnification and jurisdiction clause defined therein. Any holder of this document is advised that the information contained herein reflects the Company's findings and the level of its intervention only and will be limited to the Company's sole responsibility as its Client and this document does not constitute advice in relation to their rights and obligations under the applicable law. This document cannot be reproduced, stored in full, without prior written approval of the Company. Any circulation of partial, forged or falsified copies of this document is strictly prohibited and will be prosecuted. Unless otherwise stated, the results shown in this test report refer only to the sample(s) tested and each sample(s) are marked by 99.999.999.

F052 Version 5

SGS Korea Co., Ltd.

 322, The Ovalley, 555-a, Hoge-dong, Dongan-gu, Anyang-si, Gyeonggi-do, Korea 431-050  
 t+82 (0)31 4608 000 f+82 (0)31 4608 000 <http://www.sgslab.co.kr> [www.kr.sgs.com/guestlab](http://www.kr.sgs.com/guestlab)

Member of the SGS Group (Società Generale di Sorveglianza)

**Note:**

- 1. RL = Reporting Limit
- 2. N.D. = Not detected (lower than RL)  
NA. = Not applicable for respective material type.

The submitted sample was found to contain significant amount of specific element(s) of SVHC. Upon further test verification and also information provided from client, the possibility that the element(s) content originate from SVHC is very unlikely, even though their presence cannot be exclude entirely. It may be assumed that the detected element(s) have a non-SVHC source.

- 3. Definition of classification is listed in Appendix A of this report in accordance with 67/548/EEC and Regulation (EC) No 1907/2006. For detail information, Detail explanation is available at the following link:  
<http://echa.europa.eu/web/quest/candidate-list-table> (Candidate list)  
[http://echa.europa.eu/en/web/quest/view-article/-/journal\\_content/512b7526-9dd6-4872-934e-8c298c89ad99](http://echa.europa.eu/en/web/quest/view-article/-/journal_content/512b7526-9dd6-4872-934e-8c298c89ad99) (Potential list)
- 4. \*.The test result is based on the calculation of selected element(s) / marker(s) and to the worst-case scenario. For detail information, please refer to the SGS REACH website: [www.reach.sgs.com/substance-of-very-high-concern-analysis-information-page.htm](http://www.reach.sgs.com/substance-of-very-high-concern-analysis-information-page.htm)

The client is advised to review the chemical formulation to ascertain above metal substances present in the article.  
 RL = 0.005% is evaluated for element (i.e. cobalt, arsenic, lead, sodium, chromium, chromium(VI), silicon, aluminum, zirconium, boron, and potassium respectively), except molybdenum RL=0.0005%  
 0.1% (w/w) = 1,000 ppm = 1,000 mg/kg

- 5. \*\* β-TGIC is one of the isomers for TGIC compounds and hence, tested together. The reported test result is based the proposed ratio as according to ECHA dossier.

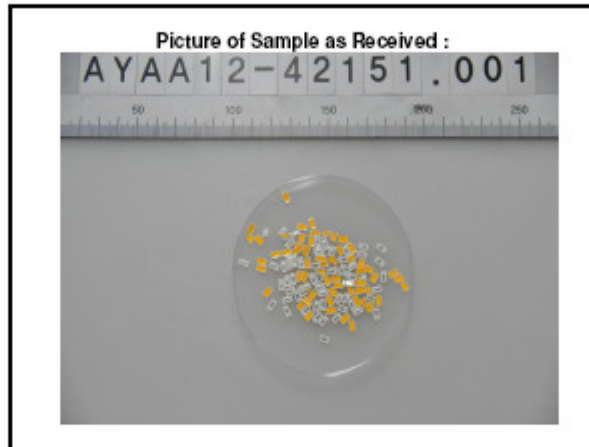

\*\*\* End of Report \*\*\*

This document is issued by the Company subject to the General Conditions of Service printed hereafter, available on request or accessible at [www.sgs.com/SGSInformationCenter/InformationCenter.aspx](http://www.sgs.com/SGSInformationCenter/InformationCenter.aspx) and for clients to whom documents subject to Terms and Conditions for Electronic Documents at [www.sgs.com/SGSInformationCenter/InformationCenter.aspx](http://www.sgs.com/SGSInformationCenter/InformationCenter.aspx). All services are subject to the Client's responsibility to provide accurate information and justify data claims before testing. Any failure of this document to provide the information requested herein reflects the Company's liability for the use of its information only and not the liability of Client's responsibility. If any. The Company's sole responsibility is to its Client and this document does not assume liability in a transaction from providing all their rights and obligations under their respective agreements. This document cannot be reproduced except in full, without prior written approval of the Company. Any use of electronic documents, images or illustrations of the content or appearance of this document is subject to prior written approval by the Company. All rights reserved.

## Appendix A

Classification	Definition under 67/548/EEC and Regulation (EC) No 1907/2006
Carcinogen Category 1:	<u>Substances known to be carcinogenic to man.</u> There is sufficient evidence to establish a causal association between human exposure to a substance and the development of cancer.
Carcinogen Category 2:	<u>Substances which should be regarded as if they are carcinogenic to man.</u> There is sufficient evidence to provide a strong presumption that human exposure to a substance may result in the development of cancer. Generally on the basis of: - appropriate long-term animal studies - other relevant information.
Mutagen Category 1:	<u>Substances known to be mutagenic to man.</u> There is sufficient evidence to establish a causal association between human exposure to a substance and heritable genetic damage.
Mutagen Category 2:	<u>Substances which should be regarded as if they are mutagenic to man.</u> There is sufficient evidence to provide a strong presumption that human exposure to the substance may result in the development of heritable genetic damage, generally on the basis of: - appropriate animal studies, - other relevant information.
Toxic to Reproduction Category 1:	<u>Substances known to impair fertility in humans.</u> There is sufficient evidence to establish a causal relationship between human exposure to the substance and impaired fertility. <u>Substances known to cause developmental toxicity in humans.</u> There is sufficient evidence to establish a causal relationship between human exposure to the substance and subsequent developmental toxic effects in the progeny.
Toxic to Reproduction Category 2:	<u>Substances which should be regarded as if they impair fertility in humans.</u> There is sufficient evidence to provide a strong presumption that human exposure to the substance may result in impaired fertility on the basis of: - clear evidence in animal studies of impaired fertility in the absence of toxic effects, or, evidence of impaired fertility occurring at around the same dose levels as other toxic effects but which is not a secondary nonspecific consequence of the other toxic effects, - other relevant information. <u>Substances which should be regarded as if they cause developmental toxicity to humans.</u> There is sufficient evidence to provide a strong presumption that human exposure to the substance may result in developmental toxicity, generally on the basis of: - clear results in appropriate animal studies where effects have been observed in the absence of signs of marked maternal toxicity, or at around the same dose levels as other toxic effects but which are not a secondary non-specific consequence of the other toxic effects, - other relevant information.
PBT & vPvB:	Substances which are persistent, bioaccumulative and toxic (PBT) or very persistent and very bioaccumulative (vPvB) pose a particular challenge to the chemicals safety management. For these substances a "safe" concentration in the environment cannot be established with sufficient reliability.

This document is issued by the Company subject to the General Conditions of Service printed hereon, available on request or accessible at <http://www.sgs.com/ServiceConditions.aspx> and, for electronic format documents, subject to Terms and Conditions for Electronic Documents at <http://www.sgs.com/ServiceConditions.aspx>. Attention is drawn to the limitation of liability, identification and jurisdiction clause defined herein. Any holder of this document is advised that the information contained herein reflects the Company's findings at the time of its issuance only and will be obsolete if there is a change in the Company's data. The Company's sole responsibility is to its Client and this document does not constitute advice or a guarantee. The Client is responsible for ensuring that all their rights and obligations under the relevant law are met. This document cannot be reproduced or used in full, without prior written approval of the Company. Any use of this document, in whole or in part, for any purpose other than that for which it was intended is prohibited. All other information contained in this report is the property of the Company and shall remain confidential.

F052 Version 5

SGS Korea Co., Ltd.

322, The Ovalley, 555-a, Hogeje-dong, Dongan-gu, Anyang-si, Gyeonggi-do, Korea 431-050  
t +82 (0)31 4608 900 f +82 (0)31 4608 999 <http://www.sgslab.co.kr> [www.kr.sgs.com](http://www.kr.sgs.com) [www.kr.sgs.com/guestlab](http://www.kr.sgs.com/guestlab)

Member of the SGS Group (Société Générale de Surveillance)

Revision History
------------------

Date	No.	Revision History	Writer	
			Drawn	Approved
2013.2.08	001	New version	W.H Jung	Y.T KIM