



**ATTENTION**  
OBSERVE PRECAUTIONS  
FOR HANDLING  
ELECTROSTATIC  
DISCHARGE  
SENSITIVE  
DEVICES

Part Number: APTB1612LZGKSYKC

Green  
Super Bright Yellow

### Features

- 1.6mmx1.25mm SMD LED, 0.65mm thickness.
- Bi-color, low power consumption.
- Wide viewing angle.
- Ideal for backlight and indicator.
- Package : 2000pcs / reel.
- Moisture sensitivity level : level 3.
- Low current IF=2mA operating.
- RoHS compliant.

### Descriptions

- The Green source color devices are made with InGaN on Sapphire Light Emitting Diode.
- The Super Bright Yellow device is made with AlGaInP (on GaAs substrate) light emitting diode chip.
- Electrostatic discharge and power surge could damage the LEDs.
- It is recommended to use a wrist band or anti-electrostatic glove when handling the LEDs.
- All devices, equipments and machineries must be electrically grounded.

### Package Dimensions

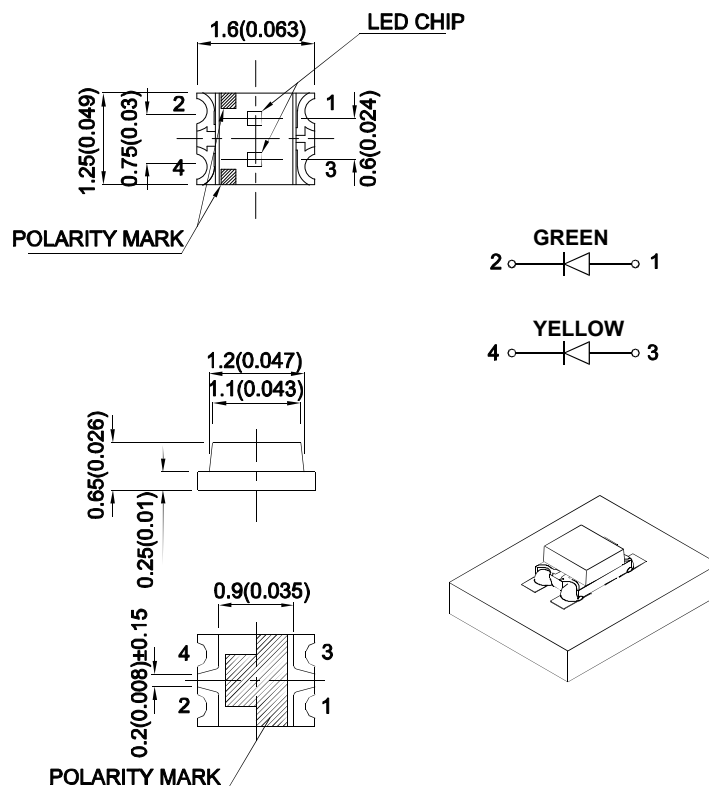

#### Notes:

1. All dimensions are in millimeters (inches).
2. Tolerance is  $\pm 0.2(0.008)$  unless otherwise noted.
3. The specifications, characteristics and technical data described in the datasheet are subject to change without prior notice.
4. The device has a single mounting surface. The device must be mounted according to the specifications.



## Selection Guide

Part No.	Emitting Color (Material)	Lens Type	Iv (mcd) [2] @ 2mA		Viewing Angle [1]
			Min.	Typ.	2θ1/2
APT B1612LZGKSYKC	Green (InGaN)	Water Clear	30	50	120°
	Super Bright Yellow (AlGaInP)		4	10	

Notes:

1. θ1/2 is the angle from optical centerline where the luminous intensity is 1/2 of the optical peak value.
2. Luminous intensity / Luminous Flux: +/-15%.
3. Luminous intensity value is traceable to the CIE127-2007 compliant national standards.

## Electrical / Optical Characteristics at TA=25°C

Symbol	Parameter	Emitting Color	Min.	Typ.	Max.	Units	Test Conditions
λpeak	Peak Wavelength	Green Super Bright Yellow		515 590		nm	IF=2mA
λD [1]	Dominant Wavelength	Green Super Bright Yellow		525 590		nm	IF=2mA
Δλ1/2	Spectral Line Half-width	Green Super Bright Yellow		35 20		nm	IF=2mA
C	Capacitance	Green Super Bright Yellow		45 20		pF	Vf=0V;f=1MHz
Vf [2]	Forward Voltage	Green Super Bright Yellow	2.2 1.5	2.65 1.85	3.1 2.1	V	IF=2mA
IR	Reverse Current	Green Super Bright Yellow			50 10	μA	VR = 5V

Notes:

1. Wavelength: +/-1nm.
2. Forward Voltage: +/-0.1V.
3. Wavelength value is traceable to the CIE127-2007 compliant national standards.
4. Excess driving current and / or operating temperature higher than recommended conditions may result in severe light degradation or premature failure.

## Absolute Maximum Ratings at TA=25°C

Parameter	Green	Super Bright Yellow	Units
Power dissipation	77.5	63	mW
DC Forward Current	25	30	mA
Peak Forward Current [1]	150	175	mA
Reverse Voltage	5		V
Electrostatic Discharge Threshold (HBM)	450	3000	V
Operating Temperature	-40°C To +85°C		
Storage Temperature	-40°C To +85°C		

Note:

1. 1/10 Duty Cycle, 0.1ms Pulse Width.

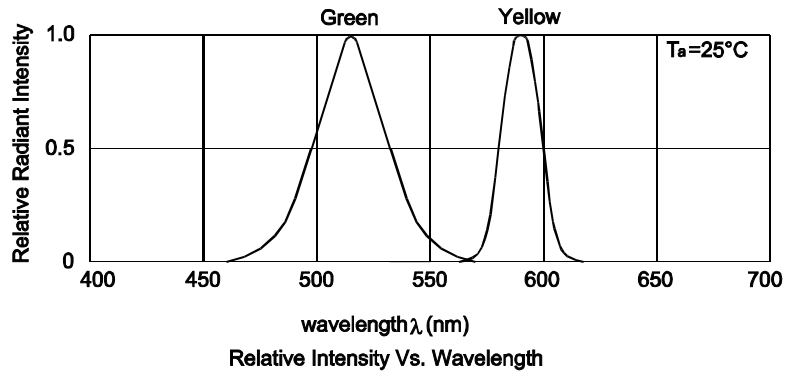

**APTB1612LZGKSYKC**  
Green

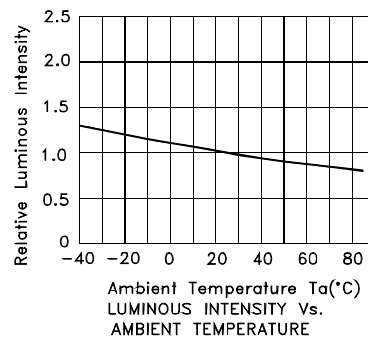
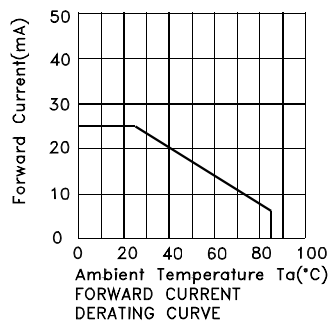
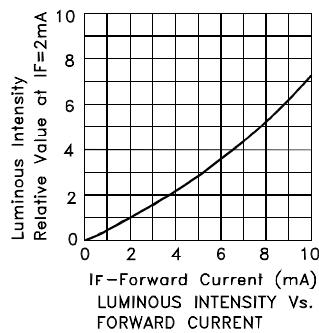
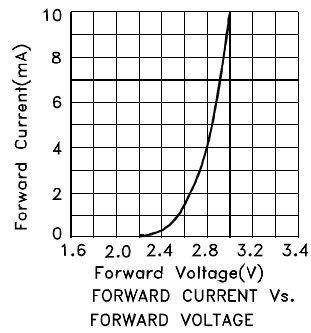

## Super Bright Yellow

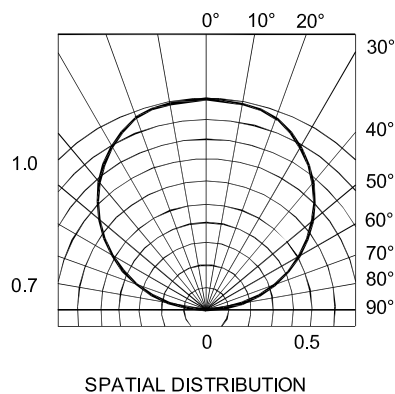
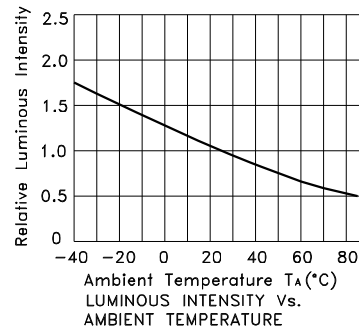
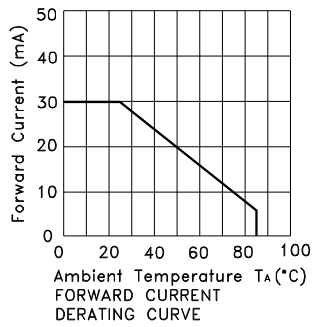
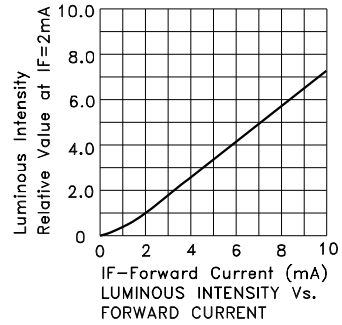
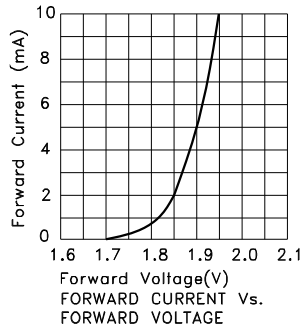

## APTB1612LZGKSYKC

Reflow soldering is recommended and the soldering profile is shown below.  
Other soldering methods are not recommended as they might cause damage to the product.

Reflow Soldering Profile For Lead-free SMT Process.



NOTES:

1. We recommend the reflow temperature 245°C (+/-5°C). The maximum soldering temperature should be limited to 260°C.
2. Don't cause stress to the epoxy resin while it is exposed to high temperature.
3. Number of reflow process shall be 2 times or less.

### Recommended Soldering Pattern (Units : mm; Tolerance: ± 0.1)



### Reel Dimension



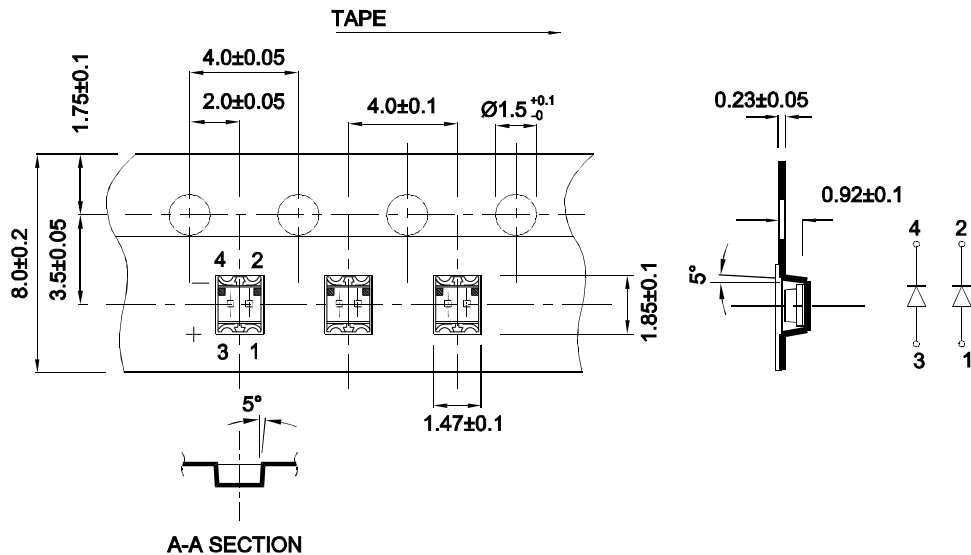

### Tape Dimensions (Units : mm)

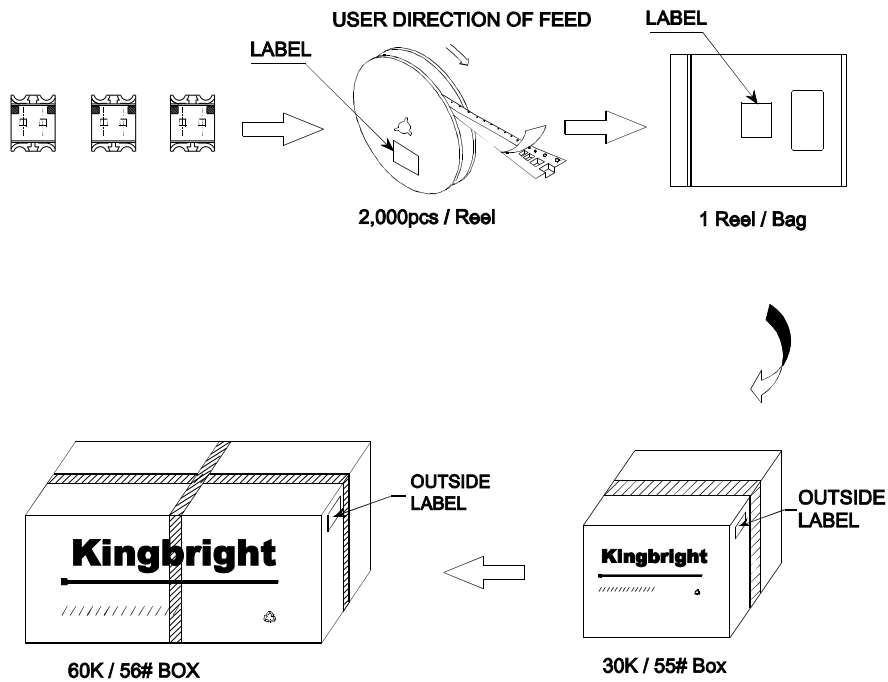

## PACKING & LABEL SPECIFICATIONS

APTB1612LZGKSYKC



<h1>Kingbright</h1>				
P/NO: APTB1612xxx				
QTY: 2,000 pcs	Q.C.			
S/N: XXXX	<table border="1"> <tr> <td>Q.C.</td> </tr> <tr> <td>xx-xx-xxxx</td> </tr> <tr> <td>PASSED</td> </tr> </table>	Q.C.	xx-xx-xxxx	PASSED
Q.C.				
xx-xx-xxxx				
PASSED				
CODE: XXX				
LOT NO:				
				
RoHS Compliant				

### Terms and conditions for the usage of this document

1. The information included in this document reflects representative usage scenarios and is intended for technical reference only.
2. The part number, type, and specifications mentioned in this document are subject to future change and improvement without notice. Before production usage customer should refer to the latest datasheet for the updated specifications.
3. When using the products referenced in this document, please make sure the product is being operated within the environmental and electrical limits specified in the datasheet. If customer usage exceeds the specified limits, Kingbright will not be responsible for any subsequent issues.
4. The information in this document applies to typical usage in consumer electronics applications. If customer's application has special reliability requirements or have life-threatening liabilities, such as automotive or medical usage, please consult with Kingbright representative for further assistance.
5. The contents and information of this document may not be reproduced or re-transmitted without permission by Kingbright.
6. All design applications should refer to Kingbright application notes available at <http://www.KingbrightUSA.com/ApplicationNotes>