

## Description

The Smart Power Relay E-1048-8C.- is a remotely controllable electronic load disconnecting relay with three functions in a single unit:

- electronic relay
- electronic overcurrent protection
- status indication

The 7 pin CUBIC version is designed for use with standard automotive relay sockets. A choice of current ratings is available from 1 A through 25 A. An operating voltage range of DC 9...32 V allows the connection of DC 12 V and DC 24 V loads.

In order to switch and protect loads remotely, it has until now been necessary to connect several discreet components together

- an electro-mechanic relay, control cable and integral contact to close the load circuit
- an additional protective element (circuit breaker or fuse) for cable or equipment protection
- a device for current measurement (shunt)

**Now type E-1048-8C combines all these functions in a single unit, thus minimising the number of connections in the circuit and thereby reducing the risk of failures.**

## Applications

Type E-1048-8C. is suited to all applications with DC 12 V or DC 24 V circuits, where magnetic valves, motors or lamp loads have to be switched, protected or monitored:

- road vehicles (utility vehicles, buses, special vehicles)
- rail vehicles
- marine industry (ships, boats, yachts etc.)

The Power Relay is also suitable for industrial use (process control, machine-building, engineering) as an electronic coupling relay between PLC and DC 12 V or DC 24 V load

## Features

- Integral power electronics provide a wear-resistant switching function, insensitive to shock and vibration.
- Only a fraction of the control power needed by electro-mechanical relays is required for switching loads. This is important for battery buffered load circuits which have to remain controlled even with the generator off line.
- The extremely low induced current consumption of less than 1 mA is absolutely necessary for battery buffered applications.
- The load circuit is disconnected in the event of an overload or short circuit, the trip curve is also suitable for smaller motor loads.
- The load circuit is permanently monitored for wire breakage.
- Two status outputs for control signal AS and group signal SF provide status indication. For processing the actual value of the current flow in a power management system an analogue output from 0 to 5 V is provided. This voltage signal may also be used as an input to a control circuit or to switch off the unit by means of external control in the event of low load current value.
- For switching and monitoring loads of 25 A plus it is possible to connect several units in parallel. Uniform power distribution between units must be ensured by symmetrical design of the supply cables (length and cross section).
- Coloured label, e. g. red = 10 A, see ordering information.

**NEW**  
with e1 approval



**E-1048-8C. CUBIC**

## Technical Data ( $T_U = 25^\circ\text{C}$ , $U_B = \text{DC } 24 \text{ V}$ ) ( $T_U = \text{ambient temperature at } U_N$ )

### Power supply LINE +

Type	DC power supply with small $R_i$ battery and generator etc.
Voltage ratings $U_N$	DC 12 V / DC 24 V
Operating voltage $U_B$ :	DC 9...32 V

### Load circuit LOAD

Load output	Power MOSFET, high side switching
Max. current rating $I_N$	25 A
Types of loads	resistive, inductive, capacitive, lamp loads, motors (depending on duration of inrush current)
Current rating range $I_N$	1 A ... 20 A (fixed ratings) up to $85^\circ\text{C}$ ambient without load reduction, 25 A up to $60^\circ\text{C}$ . Two basic versions with factory pre-set ratings: <u>version 1:</u> 1 A / 2 A / 3 A / 5 A / 7.5 A / 10 A <u>version 2:</u> 15 A / 20 A / 25 A

Induced current consumption  $I_0$  of the unit (OFF condition) < 1 mA

Typical voltage drop  $U_{ON}$

at rated current $I_N$ (at $25^\circ\text{C}$ )		$I_N$	$U_{ON}$
$I_N$	$U_{ON}$	$I_N$	$U_{ON}$
1 A	50 mV	10 A	110 mV
2 A	55 mV	15 A	70 mV
3 A	60 mV	20 A	90 mV
5 A	80 mV	25 A	120 mV
7.5 A	90 mV		

Switching point	typically $1.3 \times I_N$ ( $-40^\circ\text{C} \dots +85^\circ\text{C}$ : $1.1 \dots 1.5 \times I_N$ )
Trip time (standard curve)	typically 200 ms with switch-on onto overload and/or load increase on duty
Current limitation	<u>version 1:</u> typically 75 A <u>version 2:</u> typically 350 A
Temperature disconnection After trip	power transistor $> 150^\circ\text{C}$ - resettable via external control signal (low-high) at control input IN+ - reset of supply voltage

Parallel connection of channels for loads of 25 A plus, several units of identical current ratings may be connected in parallel. To ensure equal distribution of current between units, symmetrical design of the supply feed is necessary (length and cross section).

Leakage current in OFF condition  
version 1: max. 100  $\mu\text{A}$   
version 2: max. 500  $\mu\text{A}$

Free-wheeling diode for connected load  
integral  
version 1: max. 40 A  
version 2: max. 100 A

## Technical Data ( $T_U = 25^\circ\text{C}$ , $U_B = \text{DC } 24 \text{ V}$ ) ( $T_U = \text{ambient temperature at } U_N$ )

Delay time $t_{\text{on}} / t_{\text{off}}$ (resistive load)	typ. 5 ms / typ. 1.5 ms (EMC filter in control input)
Wire breakage monitoring in ON and OFF condition of load	<p>wire breakage thresholds:</p> <p>in OFF-condition (version1):  <math>R_{\text{load}} &gt;</math> typically 100 k<math>\Omega</math></p> <p>in OFF-condition (version2):  <math>R_{\text{load}} &gt;</math> typically 10 k<math>\Omega</math></p> <p>in ON-condition: <math>I_{\text{load}} &lt;</math> typically <math>0.2 \times I_N</math></p> <p>indication via group fault signalisation FM (switching output)            Fault indication will not be stored, i.e. after remedy of wire breakage fault indication will disappear            (possible options:            - wire breakage indication only in ON condition            - wire breakage indication only in OFF condition            - no wire breakage indication)            - disconnection of load, indication via group signal SF            - no automatic re-start            - after remedy of the fault unit has to be reset via control input IN+</p>
Short circuit, overload in load circuit	<p>- disconnection of load, indication via group signal SF            - no automatic re-start            - after remedy of the fault unit has to be reset via control input IN+</p>

### Control input IN+

Control voltage IN+	0...5 V = "OFF", 8.5...32 V = "ON"
Control current $I_E$	1...10 mA (8.5...DC32V)
Reset in the event of a failure	<p>- reset via external control signal (low - high) at control input IN+</p> <p>- via reset of supply voltage</p>
Dimmer operation (e.g. PWM signal)	possible, see max. switching frequency

Switching frequency at resistive or inductive load	max. 100 Hz
--	-------------

### Status and diagnostic functions

Control signal AS	transistor output minus switching (LSS), open collector, short circuit and overload proof, max. load: DC 32 V/2 A 0 V-level: when unit is set (at IN+ = 8.4...32 V)
-------------------	--

Group signal SF	transistor output minus switching (LSS), open collector, short circuit and overload proof, load max. DC 32 V/2 A 0 V-level with overload and short circuit disconnection, wire breakage indication
-----------------	---

Analogue output U(I)	<p>voltage output 0-5 V proportional to load current:</p> <p>1 V = <math>0.2 \times I_N</math>            5 V = <math>1.0 \times I_N</math>            5 V... typically 6.5 V = overload range tolerance: (for <math>I_{\text{load}} &gt; 0.2 \times I_N</math>)  <u>version 1:</u> <math>\pm 5 \%</math> of <math>I_N</math>  <u>version 2:</u> <math>\pm 8 \%</math> of <math>I_N</math>            max. output current 5 mA            load resistance <math>&gt; 1 \text{ k}\Omega</math> against GND            response time when switching on a load:  <math>t_{90} =</math> typically 20 ms            response time of load change on duty:  <math>t_{90} =</math> typically 1 ms</p>
----------------------	--

### Visual status indication

control signal AS	LED yellow
group fault signal SF	LED red

### General data

#### Reverse polarity protection

Control circuit	yes
Load circuit	no (due to integral free-wheeling diode)
Status outputs	interference voltage resistance max. DC 32 V

## Technical Data ( $T_U = 25^\circ\text{C}$ , $U_B = \text{DC } 24 \text{ V}$ ) ( $T_U = \text{ambient temperature at } U_N$ )

<b>Temperature range</b>	
ambient temperature	<p>- standard: <math>-40...+85^\circ\text{C}</math>            without load reduction (<math>60^\circ\text{C}</math> at 25 A)            - for other temperature ranges please see ordering key</p>

### Tests

Humid heat	combined test, 9 cycles with functional test
Temperature change	test to DIN EN 60068-2-30, Z/AD min. temperature $-40^\circ\text{C}$ , max. temperature $+90^\circ\text{C}$
Vibration (random)	test to DIN IEC 60068-2-14, Nb in operation, with temperature change 6 g eff. (10 Hz...2000 Hz)
Shock	test to DIN EN 60068-2-27 25 g/11 ms, 10 shocks
Corrosion	test to DIN EN 60068-2-52, severity 3
Protection class	housing -8C4 IP30 to DIN 40050 housing -8C5 IP54 to DIN 40050, higher protection class upon request
EMC requirements	EMC directive: emitted interference EN 50081-1 noise immunity EN 61000-6-2 Automotive directive: emitted interference, noise immunity: 72/245/EW6 und 95 / 54 / E6

### Terminals of CUBIC version (7 pin, standard)

Mounting:	5 blade terminals 6.3 mm x 0.8 mm and 2 blade terminals 2.8 mm x 0.6 mm to DIN 46244 Contact material CuZn37F44 - on automotive relay socket 7 pole or 9 pole
-----------	---

### Housing CUBIC

max. dimensions	30 x 30 x 40 mm when plugged in 30 x 30 x 51.6 mm including terminals
Materials	CUBIC: housing PA66-GF30 base plate PA6-GF30
Mass	approx. 23 g...43 g, depending on version

### Approvals

CE, e1 logo	according to EU, EMC and automotive directives, approvals no. e1 023880
-------------	---

## Ordering Information

### Type

**E-1048-8C** Smart Power Relay DC 12 V/24 V - 1 A...20 A (25 A) in CUBIC housing

### Housing / temperature range

- 4** with housing -40 °C...85 °C (60 °C at I<sub>N</sub> = 25 A)
- 5** with housing -40 °C...85 °C (60 °C at I<sub>N</sub> = 25 A) increased environmental requirements (IP protection class etc.)

### Control input

**C** with control input (+ control 8.5...32 V)

### LEDs

- 0** without
- 3** 2 LEDs: AS yellow, SF red

### Status output minus-switching

- A** without
- B** with control signal AS
- C** with group fault signal SF
- D** with AS and SF

### Contents of group fault signal SF/ LED indication SF

- 0** without
- 1** short circuit / overload
- 2** short circuit / overload + wire breakage off
- 3** short circuit / overload + wire breakage on
- 4** short circuit / overload + wire breakage on + wire breakage on

### Analog output

- V0** without
- V1** 0...5V

### Characteristic curve

- 1** 50 ms (switch-off delay with overload)
- 2** 100 ms (switch-off delay with overload)
- 4** 200 ms standard (switch-off delay with overload)

### Voltage rating

**U3** DC 12/24 V

### Current ratings / colour of label

- 1 A** / black
- 2 A** / grey
- 3 A** / purple
- 5 A** / light-brown
- 7.5 A** / brown
- 10 A** / red
- 15 A** / blue
- 20 A** / yellows
- 25 A** / white

**E-1048-8C 5 - C 3 D 4 V1-4 U3 - 20 A**

ordering example 1: "DELUXE"-version 7 pin

**E-1048-8C 4 - C 0 A 0 V0-4 U3 - 5 A**

ordering example 2: "BASIC"-version 4 pin

## Dimensions CUBIC (7 pin version)

with all options: - LED indications AS/SF  
- signal outputs AS/SF  
- analogue output U (I)

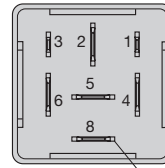

2, 4, 5, 6 and 8 - blade terminals 6.3 x 0.8  
1 and 3 - blade terminals 2.8 x 0.6

footprint  
to ISO 7588

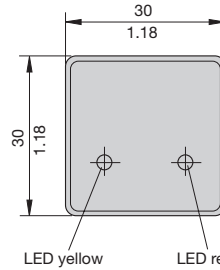
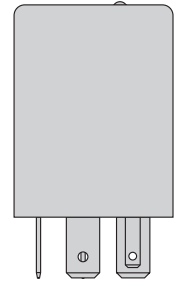
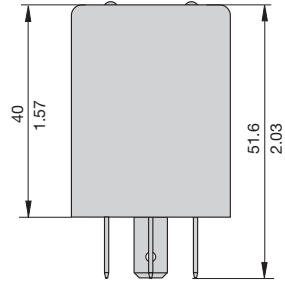

LED yellow LED red

## Dimensions BASIC (4 pin version)

without options: - LED indication AS/SF  
- signal outputs AS/SF  
- analogue output U (I)

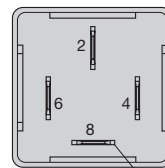

2, 4, 6 and 8 - blade terminals 6.3 x 0.8

footprint  
to ISO 7588

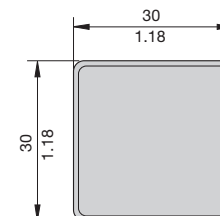
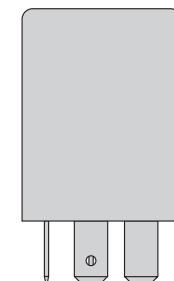
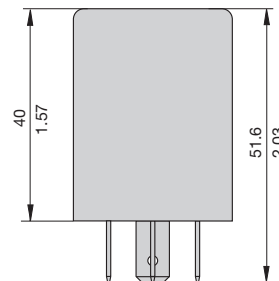

This is a metric design and millimeter dimensions take precedence ( $\frac{\text{mm}}{\text{inch}}$ )

## Typical time/current characteristics (standard 200 ms)

**Version 1:** 1 A, 2 A, 3 A, 5 A, 7.5 A and 10 A

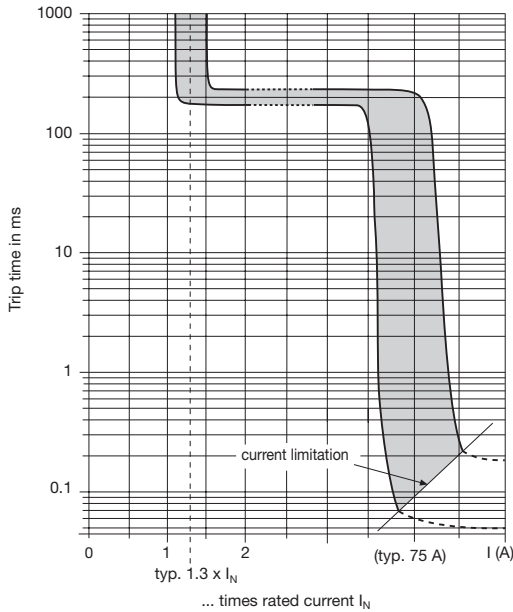

**Version 2:** 15 A, 20 A and 25 A

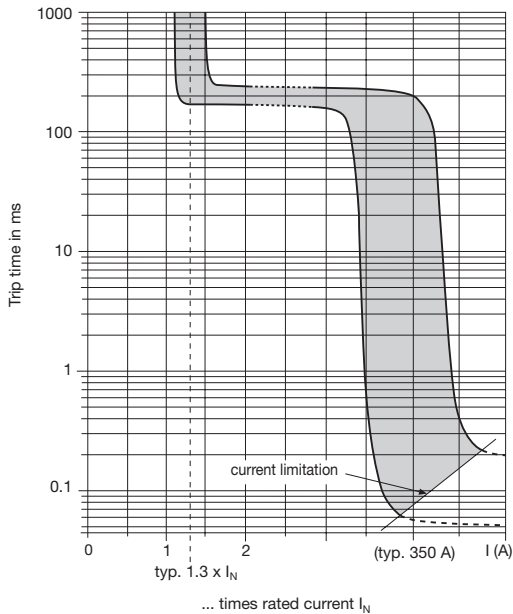

## Connection diagram

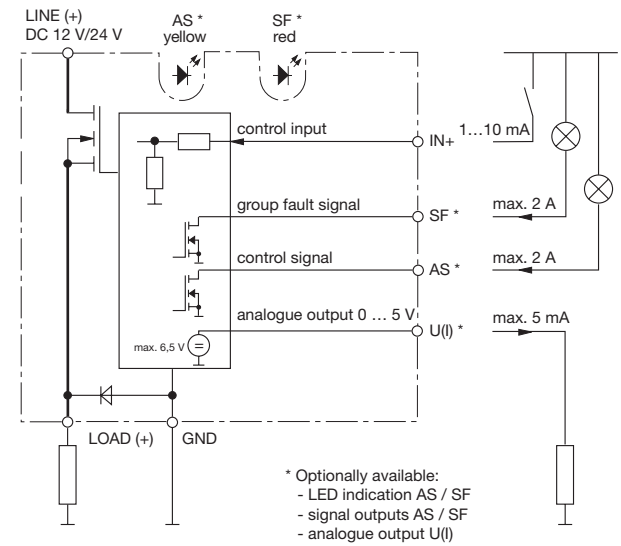

## Pin selection (7 pin = "DELUXE")

### E-1048-8C. Cubic

AS	(1)	control signal (≙ LED yellow)
LINE +	(2)	plus $U_B$ (DC 12 V/24 V)
SF	(3)	group fault signal (≙ LED red)
IN+	(4)	control input
U(I)	(5)	0 ... 5 V analogue output
GND	(6)	minus $U_B$
LOAD	(8)	load output

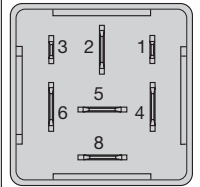

## Pin selection (4 pin = "BASIC")

### E-1048-8C. Cubic

LINE +	(1)	plus $U_B$ (DC 12 V/24 V)
IN+	(4)	control input
GND	(6)	minus $U_B$
LOAD	(8)	load output

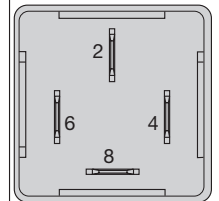

All dimensions without tolerances are for reference only. In the interest of improved design, performance and cost effectiveness the right to make changes in these specifications without notice is reserved. Product markings may not be exactly as the ordering codes. Errors and omissions excepted.