

SCA3300

Data Sheet

SCA3300-D01 3-axis Industrial Accelerometer and Inclinometer with Digital SPI Interface

Features

- 3-axis high performance accelerometer with $\pm 1.5g$ to $\pm 6g$ user selectable measurement range
- Extensive self-diagnostics features
- Excellent bias stability and low noise level
- Mechanically damped sensing element design for superior vibration robustness
- SPI digital interface
- $-40^{\circ}\text{C} \dots +125^{\circ}\text{C}$ operating temperature range
- 3.0V...3.6V supply voltage with low 1mA current consumption
- RoHS compliant robust DFL plastic package suitable for lead free soldering process and SMD mounting
- Proven capacitive 3D-MEMS technology

Applications

SCA3300-D01 is targeted at applications demanding high stability with tough environmental requirements.

Typical applications include:

- Professional Leveling
- Platform Angle Measurement
- Tilt Compensation
- Inertial Measurement Units (IMUs) for highly demanding environments
- Motion Analysis and Control
- Navigation Systems

Overview

The SCA3300-D01 is a high performance accelerometer sensor component. It is three axis accelerometer sensor based on Murata's proven capacitive 3D-MEMS technology. Signal processing is done in mixed signal ASIC with flexible SPI digital interface. Sensor element and ASIC are packaged to 12 pin premolded plastic housing that guarantees reliable operation over product's lifetime.

The SCA3300-D01 is designed, manufactured and tested for high stability, reliability and quality requirements. The component has extremely stable output over wide range of temperature and vibration. The component has several advanced self diagnostics features, is suitable for SMD mounting and is compatible with RoHS and ELV directives.



TABLE OF CONTENTS

1	Introduction.....	3
2	Specifications.....	3
2.1	General Specifications.....	3
2.2	Performance Specifications.....	3
2.3	Performance Specification for Temperature Sensor.....	4
2.4	Absolute Maximum Ratings.....	4
2.5	Pin Description.....	5
2.6	Typical Performance Characteristics.....	6
2.7	Digital I/O Specification.....	9
2.8	Measurement Axis and Directions.....	11
2.9	Package Characteristics.....	12
2.10	PCB Footprint.....	13
3	General Product Description.....	14
3.1	Factory Calibration.....	15
4	Component Operation, Reset and Power Up.....	15
4.1	Recommended Start Up Sequence.....	15
4.2	Recommended Operation Sequence.....	15
5	Component Interfacing.....	16
5.1	General.....	16
5.2	Protocol.....	16
5.3	SPI Frame.....	17
5.4	Example of Acceleration Data Conversion.....	18
5.5	Example of Temperature Data Conversion.....	18
5.6	Example of Self-Test Analysis.....	19
6	Application Information.....	20
6.1	Application Circuitry and External Component Characteristics.....	20
6.2	Assembly Instructions.....	21

1 Introduction

This document contains essential technical information about the SCA3300-D01 sensor including specifications, SPI interface descriptions, electrical properties and application information. This document should be used as a reference when designing in SCA3300-D01 component.

2 Specifications

2.1 General Specifications

General specifications for SCA3300-D01 component are presented in Table 1. All analog voltages are referenced to the potential at AVSS and all digital voltages are referenced to the potential at DVSS.

Table 1. General specifications.

Parameter	Condition	Min	Typ	Max	Units
Supply voltage: VDD, DVIO		3.0	3.3	3.6	V
I_VDD	Normal mode		1.2		mA

2.2 Performance Specifications

Table 2. Accelerometer performance specifications (VDD=3.3V and room temperature unless otherwise specified).

Parameter	Condition	Min	Typ	Max	Unit
Measurement range	Measurement axes XYZ	-6		6	g
Offset (zero acceleration output)			0		LSB
Offset error ^(A)			±20 ±1.15		mg °
Offset temperature drift ^(B)	X-,Y-axis -40°C ... +125°C		±10 ±0.57		mg °
	Z-axis -40°C ... +125°C		±15 ±0.86		mg °
Sensitivity	±1.5g Mode 4 and Mode 3		5400		LSB/g
	±3g Mode 1		2700		
	±6g Mode 2		1350		
Sensitivity error ^(A)			±0.7		%
Sensitivity temperature drift ^(B)	-40°C ... +125°C		±0.3		%
Linearity error ^(C)	-1g ... +1g range		±1		mg
	-6g ... +6g range		±15		mg
Integrated noise (RMS)	In mode 3 1.5g			1.2	mg _{RMS}
Noise density	In mode 3 1.5g		37		µg/√Hz
Cross axis sensitivity ^(D)	per axis	-1		+1	%
Amplitude response -3dB frequency	Mode 1, Mode 2 and Mode 3		88		Hz
	Mode 4		10		Hz
Power on start-up time			1		ms
ODR	Normal mode		2000		Hz

VALUES ARE ±3 SIGMA VARIATION LIMITS FROM TEST POPULATION. VALUES ARE NOT GUARANTEED.

- A. INCLUDES CALIBRATION ERROR AND DRIFT OVER LIFETIME.
- B. DEVIATION FROM VALUE AT ROOM TEMPERATURE.
- C. STRAIGHT LINE THROUGH SPECIFIED MEASUREMENT RANGE END POINTS.
- D. CROSS AXIS SENSITIVITY IS THE MAXIMUM SENSITIVITY IN THE PLANE PERPENDICULAR TO THE MEASURING DIRECTION. X-AXIS OUTPUT CROSS AXIS SENSITIVITY (CROSS AXIS FOR Y AND Z-AXIS OUTPUTS ARE DEFINED CORRESPONDINGLY):
 CROSS AXIS FOR Y AXIS = SENSITIVITY Y / SENSITIVITY X
 CROSS AXIS FOR Z AXIS = SENSITIVITY Z / SENSITIVITY X

2.3 Performance Specification for Temperature Sensor

Table 3. Temperature sensor performance specifications.

Parameter	Condition	Min.	Typ	Max.	Unit
Temperature signal range		-50		+150	°C
Temperature signal sensitivity	Unsigned 16-bit word		18.9		LSB/°C
Temperature signal offset	°C output	-283	-273	-263	°C

Temperature is converted to °C with following equation:

$$Temperature [^{\circ}C] = -273 + (TEMP / 18.9),$$

where TEMP is temperature sensor output in decimal format.

2.4 Absolute Maximum Ratings

Within the maximum ratings (Table 4), no damage to the component shall occur. Parametric values may deviate from specification, yet no functional failure shall occur.

Table 4. Absolute maximum ratings.

Parameter	Remark	Min.	Typ	Max.	Unit
VDD	Supply voltage analog circuitry	-0.3		4.3	V
DIN/DOUT	Maximum voltage at digital input and output pins	-0.3		DVIO+0.3	V
Topr	Operating temperature range	-40		125	°C
Tstg	Storage temperature range	-40		150	°C
ESD_HBM	ESD according Human Body Model (HBM), Q100-002	±2000			V
ESD_CDM	ESD according Charged Device Model (CDM), Q100-011	±500 ±750 (corner pins)			V
US	Ultrasonic agitation (cleaning, welding, etc)	Prohibited			

2.5 Pin Description

The pinout for SCA3300-D01 is presented in Figure 1, while the pin descriptions can be found in Table 5.

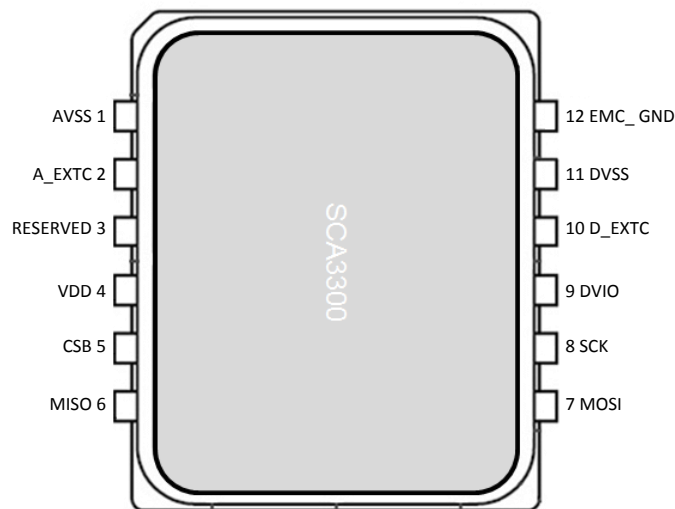

Figure 1. Pinout for SCA3300-D01.

Table 5. SCA3300-D01 pin descriptions.

Pin#	Name	Type	Description
1	AVSS	GND	Analog reference ground, connect externally to AVSS
2	A_EXTC	AOUT	External capacitor connection for positive reference voltage
3	RESERVED	-	Factory use only, leave floating or connect to GND
4	VDD	SUPPLY	Analog Supply voltage
5	CSB	DIN	Chip Select of SPI Interface, 3.3V logic compatible Schmitt-trigger input
6	MISO	DOUT	Data Out of SPI Interface
7	MOSI	DIN	Data In of SPI Interface, 3.3V logic compatible Schmitt-trigger input
8	SCK	DIN	CLK signal of SPI Interface
9	DVIO	SUPPLY	SPI interface Supply Voltage
10	D_EXTC	AOUT	External capacitor connection for digital core
11	DVSS	GND	Digital Supply Return, connect externally to GND
12	EMC_GND	EMC GND	EMC ground pin, connect externally to AVSS

2.6 Typical Performance Characteristics

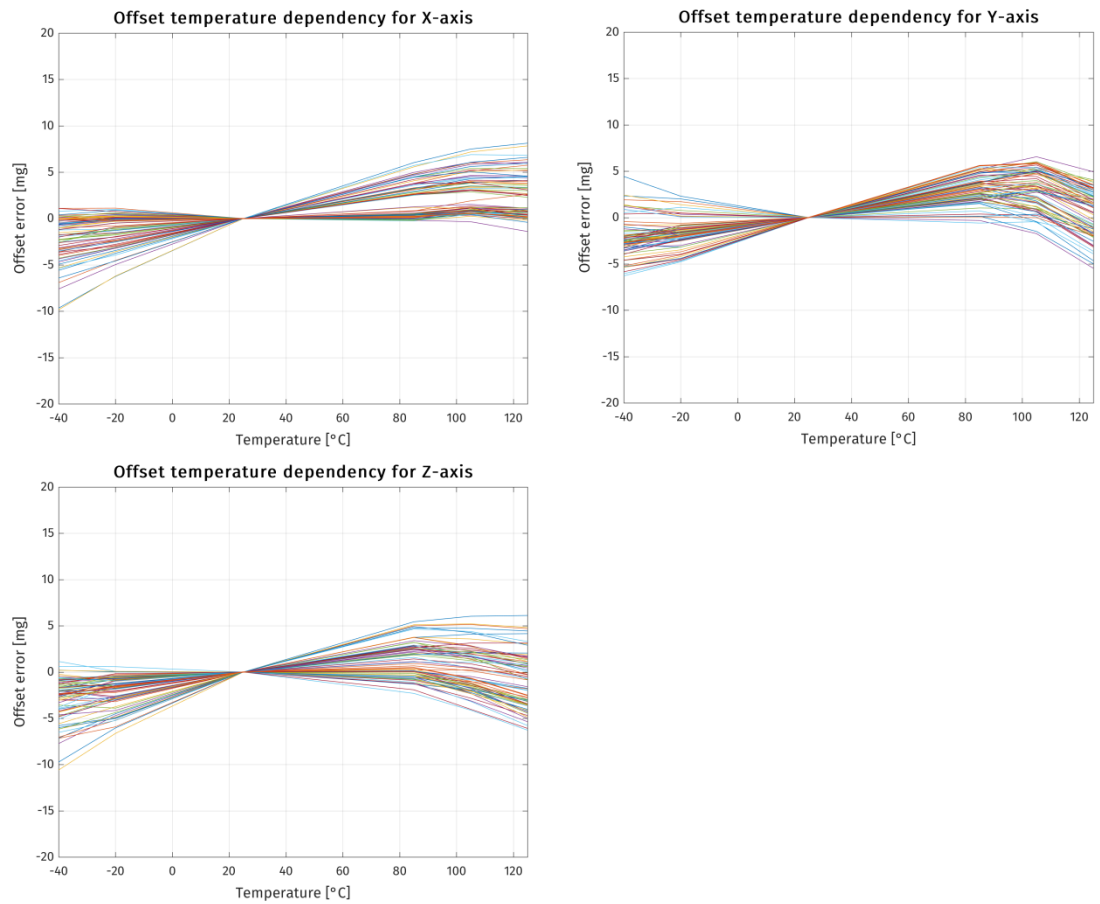

Figure 2. SCA3300-D01 accelerometer typical offset temperature behavior.

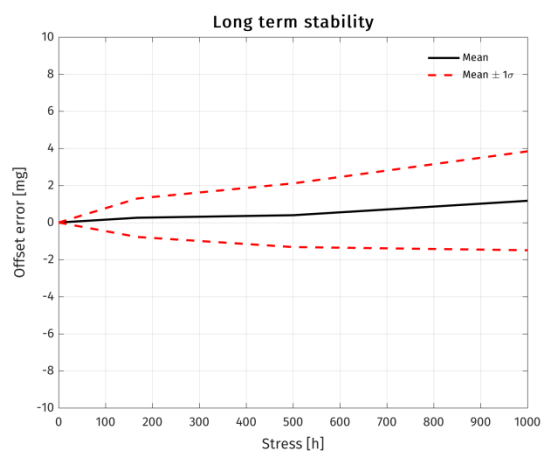

Figure 3. SCA3300-D01 accelerometer typical long term stability during 1000h HTOL. $T=+125^{\circ}\text{C}$
 $V_{\text{supply}}=3.6\text{V}$

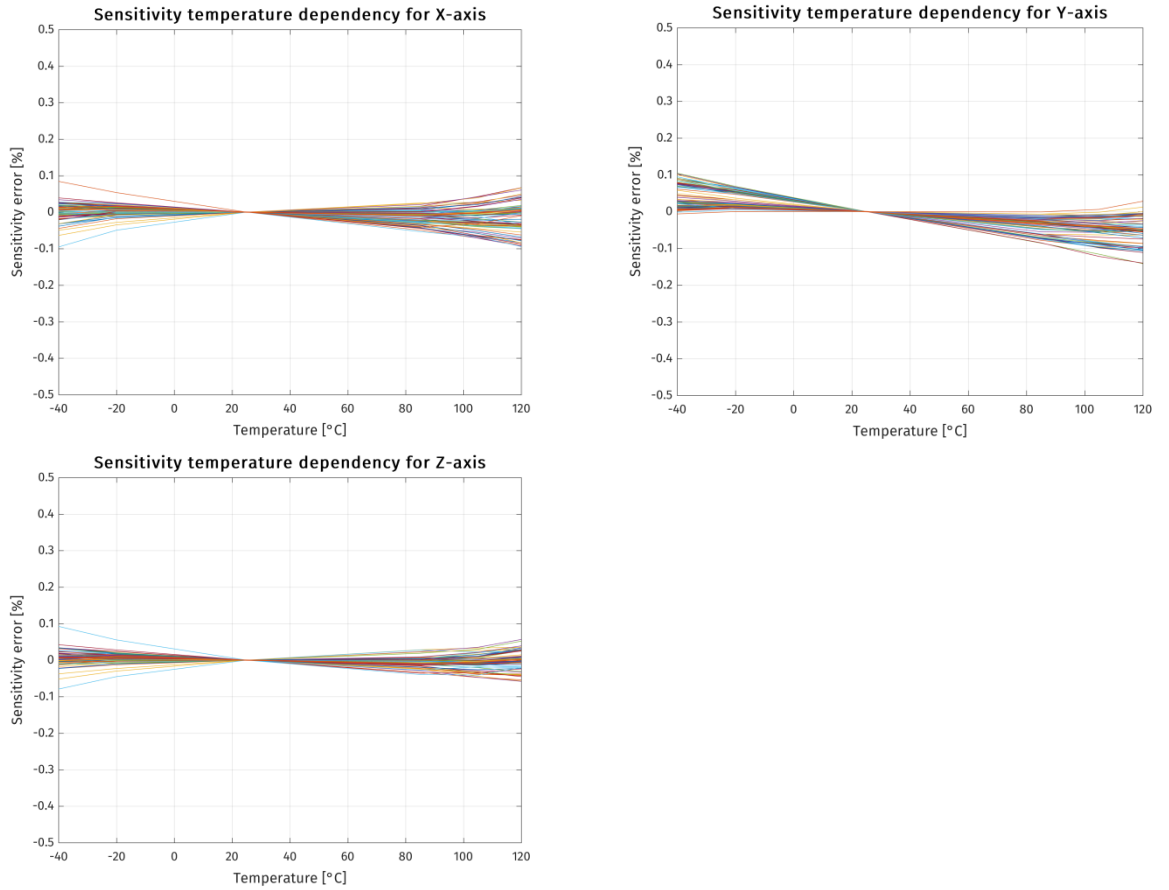

Figure 4. SCA3300-D01 accelerometer typical sensitivity temperature error in %.

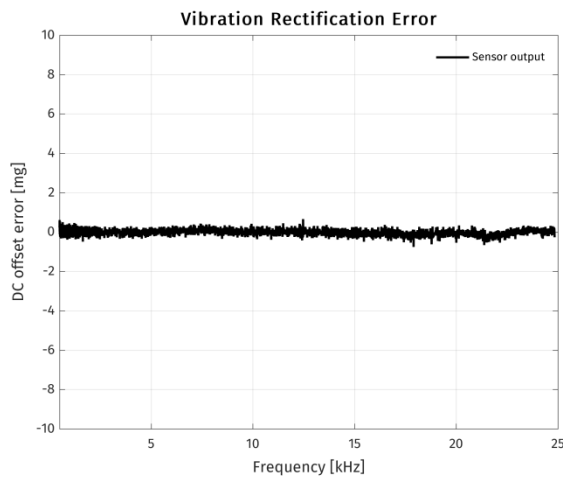

Figure 5. Vibration rectification error. Sine sweep 500...5KHz with 4g amplitude and 5kHz...25kHz with 2g amplitude.

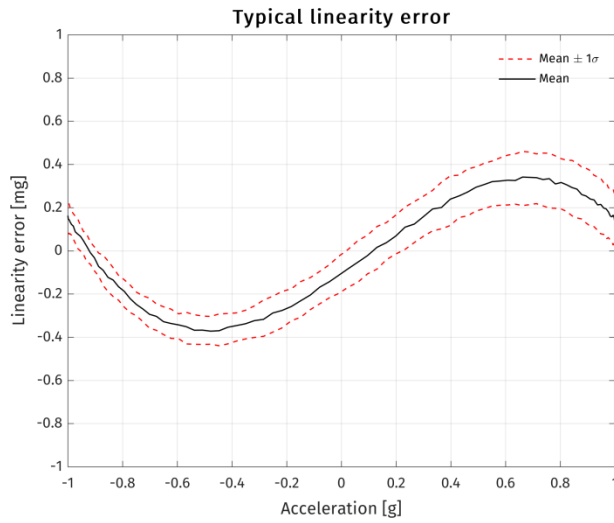

Figure 6. SCA3300-D01 accelerometer typical linearity behavior.

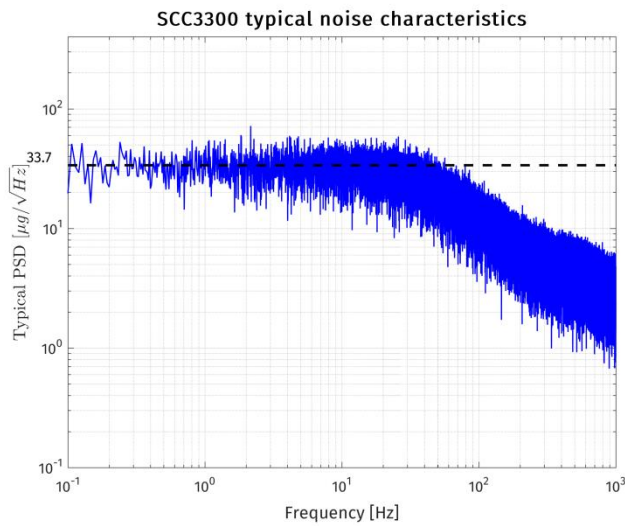

Figure 7. SCA3300-D01 accelerometer typical noise density

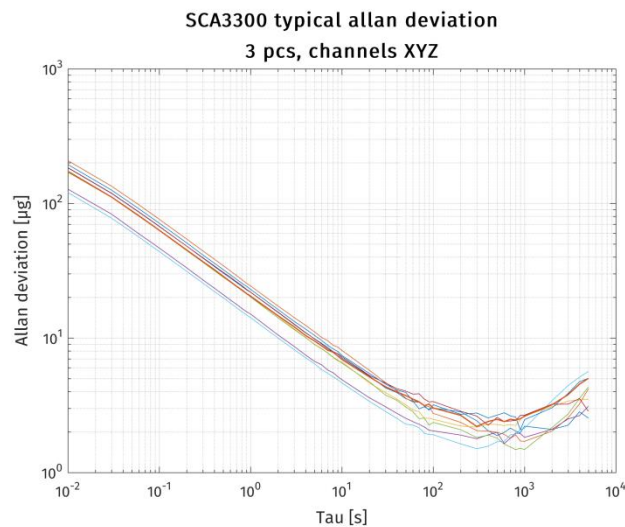

Figure 8. SCA3300-D01 typical allan deviation.

2.7 Digital I/O Specification

2.7.1 DC Characteristics

Table 6. Input terminal: CSB

	Parameter	Conditions	Symbol	Min	Typ	Max	Unit
1	Pull-up current	VIN = 0V	IPU	10	16.5	50	uA
2	Input voltage '1'	DVIO = 3.3 V	V _{IH}	2.5		DVIO	V
3	Input voltage '0'	DVIO = 3.3 V	V _{IL}	0		1.1	V

Table 7. Input terminal: MOSI, SCK

	Parameter	Conditions	Symbol	Min	Typ	Max	Unit
1	Pull-down current	VIN = 0V	IPU	10	16.5	50	uA
2	Input voltage '1'	DVIO = 3.3 V	V _{IH}	2.5		DVIO	V
3	Input voltage '0'	DVIO = 3.3 V	V _{IL}	0		1.1	V

Table 8. Output terminal: MISO

	Parameter	Conditions	Symbol	Min	Typ	Max	Unit
9	Output high voltage	I > -1 mA DVIO = 3.3 V	V _{OH}	DVIO- 0.5V			uA
10	Output low voltage	I < 1 mA	V _{OL}			0.5	V
11	Tri-state leakage	0 < VMISO < 3.3 V	I _{LEAK}		TBD		uA
12	Maximum Capacitive load					50	pF

2.7.2 SPI AC Characteristics

The AC characteristics of SCA3300-D01 SPI interface are defined in Figure 9 and Table 9.

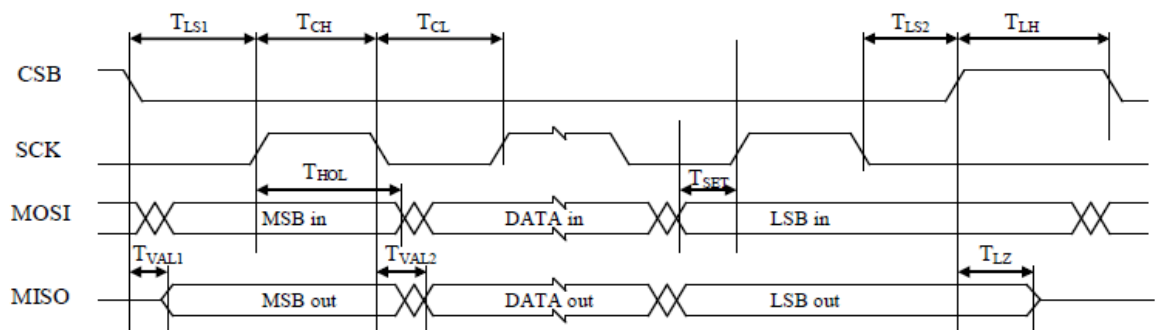

Figure 9. Timing diagram of SPI communication.

Table 9. SPI AC electrical characteristics.

Terminals	Parameter	Description	Min	Typ	Max	Unit
SCK	TCL	SCK low time	$T_{per}/2$	200		ns
	TCH	SCK high time	$T_{per}/2$	200		ns
	$f_{SCK} = 1/T_{per}$	SCK Frequency	0.1	2.5	8	MHz
CSB, SCK	TLS1	Time from CSB (10%) to SCK (90%)	$T_{per}/2$	1740		ns
	TLS2	Time from SCK (10%) to CSB (90%)	$T_{per}/2$	920		ns
MOSI, SCK	TSET	Time from changing MOSI (10%, 90%) to SCK (90%). Data setup time	$T_{per}/4$	200		ns
	THOL	Time from SCK (90%) to changing MOSI (10%, 90%). Data hold time	$T_{per}/4$	200		ns
MISO, CSB	TVAL1	Time from CSB (10%) to stable MISO (10%, 90%)		120		ns
	TLZ	Time from CSB (90%) to high impedance state of MISO		110		ns
SCK, MISO	TVAL2	Time from SCK (10%) to stable MISO (10%, 90%)		110		ns
MISO	LOAD	Capacitive load			50	pF
CSB	TLH	Time between SPI cycles, CSB at high level (90%)	10			us

2.8 Measurement Axis and Directions

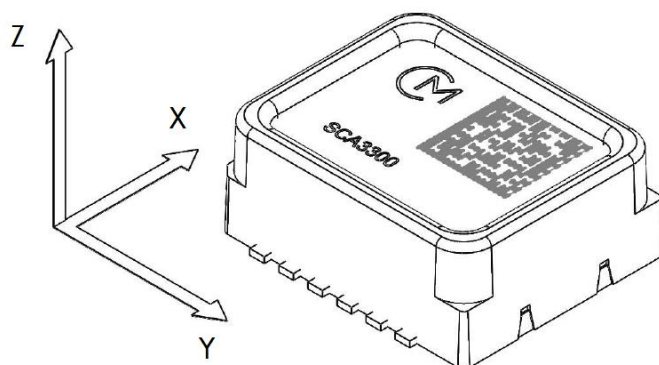







Figure 10. SCA3300-D01 measurement directions.

Table 10. SCA3300-D01 accelerometer measurement directions.

 <p>x: 0g y: 0g z: +1g</p>	 <p>x: +1g y: 0g z: 0g</p>	 <p>x: 0g y: 0g z: -1g</p>
 <p>x: 0g y: -1g z: 0g</p>	 <p>x: -1g y: 0g z: 0g</p>	 <p>x: 0g y: +1g z: 0g</p>

2.9 Package Characteristics

2.9.1 Package Outline Drawing

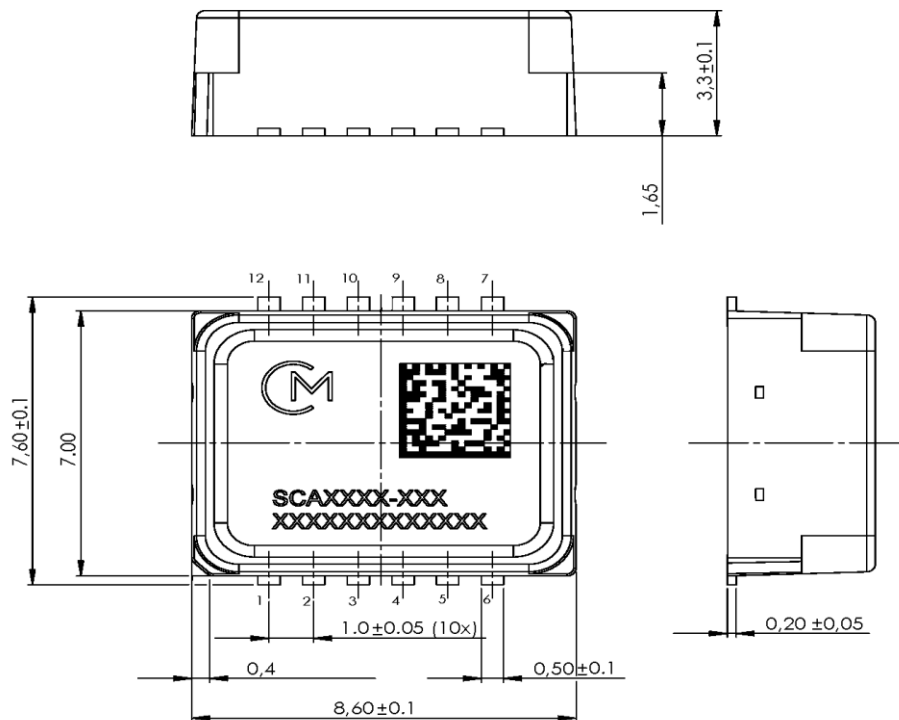

Figure 11. Package outline. The tolerances are according to ISO2768-f (see Table 11).

Table 11. Limits for linear measures (ISO2768-f).

Tolerance class	Limits in mm for nominal size in mm		
	0.5 to 3	Above 3 to 6	Above 6 to 30
f (fine)	$\pm 0,05$	$\pm 0,05$	$\pm 0,1$

2.10 PCB Footprint

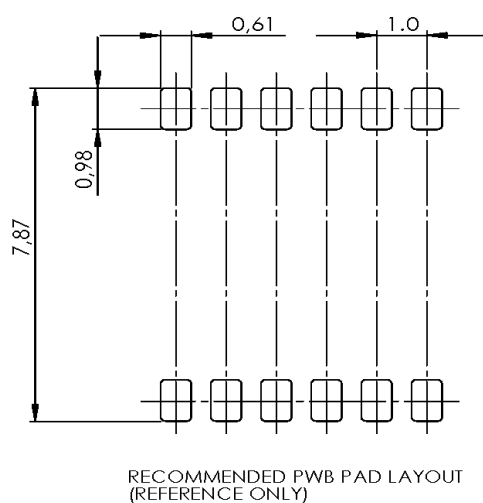

Figure 12. Recommended PWB pad layout for SCA3300-D01. The tolerances are according to ISO2768-f (see Table 11).

3 General Product Description

The SCA3300-D01 sensor includes acceleration sensing element and Application-Specific Integrated Circuit (ASIC). Figure 13 contains an upper level block diagram of the component.

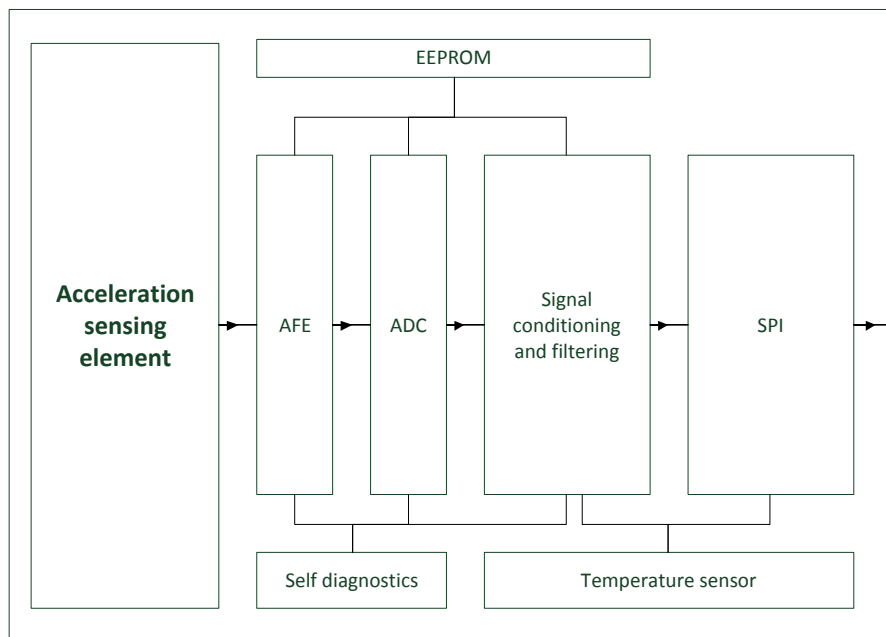

Figure 13. SCA3300-D01 component block diagram.

The sensing elements are manufactured using Murata proprietary High Aspect Ratio (HAR) 3D-MEMS process, which enables making robust, extremely stable and low noise capacitive sensors.

The acceleration sensing element consists of four acceleration sensitive masses. Acceleration causes capacitance change that is converted into a voltage change in the signal conditioning ASIC.

3.1 Factory Calibration

SCA3300-D01 sensors are factory calibrated. No separate calibration is required in the application. Calibration parameters are stored to non-volatile memory during manufacturing. The parameters are read automatically from the internal non-volatile memory during the start-up.

It should be noted that assembly can cause minor offset/bias errors to the sensor output. If best possible offset/bias accuracy is required, system level offset/bias calibration (zeroing) after assembly is recommended.

4 Component Operation, Reset and Power Up

4.1 Recommended Start Up Sequence

Item	Procedure	Function	Note
1	Set VDD = 3.0 .. 3.6 V Set DVIO = 3.0 .. 3.6 V	<ul style="list-style-type: none"> Startup the device 	VDD and DVIO don't need to rise at the same time
2	Wait 10 ms	<ul style="list-style-type: none"> Memory reading Settling of signal path 	
3	Set Measurement mode	<ul style="list-style-type: none"> Select operation mode 	Mode1: 3g full-scale. 88 Hz 1st order low pass filter (default) Mode2: 6g full-scale. 88 Hz 1st order low pass filter Mode3: 1.5g full-scale. 88 Hz 1st order low pass filter. Mode4: 1.5g full-scale. 10 Hz 1st order low pass filter.
4	Wait 5 ms	<ul style="list-style-type: none"> Settling of signal path 	
5	Read ERR_STATUS, ACCX, ACCY, ACCZ, STO	<ul style="list-style-type: none"> Read error status and acceleration data and self-test output 	

4.2 Recommended Operation Sequence

Sensor ODR in normal operation mode is 2000Hz. Registers are updated in every 0.5ms and if all data is not read the full noise performance of sensor is not met.

During normal operation during every cycle needed acceleration outputs ACCX, ACCY, ACCZ are read in wanted ODR. Error summary is read if return status (RS) indicates error.

For fail safe option self-test output STO is read after reading all corresponding acceleration outputs. If STO is not within $\pm 400d$ then corresponding acceleration readings are not reliable. If STO is not returned within limits in no vibration condition after HW reset, it is possible that component failure has occurred.

5 Component Interfacing

5.1 General

SPI communication transfers data between the SPI master and SCA3300-D01 ASIC. The SCA3300-D01 always operates as a slave device in master-slave operation mode. 3-wire SPI connection cannot be used.

SPI interface pins:

CSB	Chip Select (active low)	MCU → ASIC
SCK	Serial Clock	MCU → ASIC
MOSI	Master Out Slave In	MCU → ASIC
MISO	Master In Slave Out	ASIC → MCU

5.2 Protocol

The SPI is a 32-bit 4-wire slave configured bus. Off-frame protocol is used so each transfer consists of two phases. A response to the request is sent within next request frame. The response concurrent to the request contains the data requested by the previous command.

The SPI transmission is always started with the falling edge of chip select (CSB) and terminated with the CSB rising edge. The data bits are sampled from MOSI line at the rising edge of the SCK signal and it is propagated on the falling edge (MISO line) of the SCK. This equals to SPI Mode 0 (CPOL = 0 and CPHA = 0).

The first bit in a sequence is an MSB.

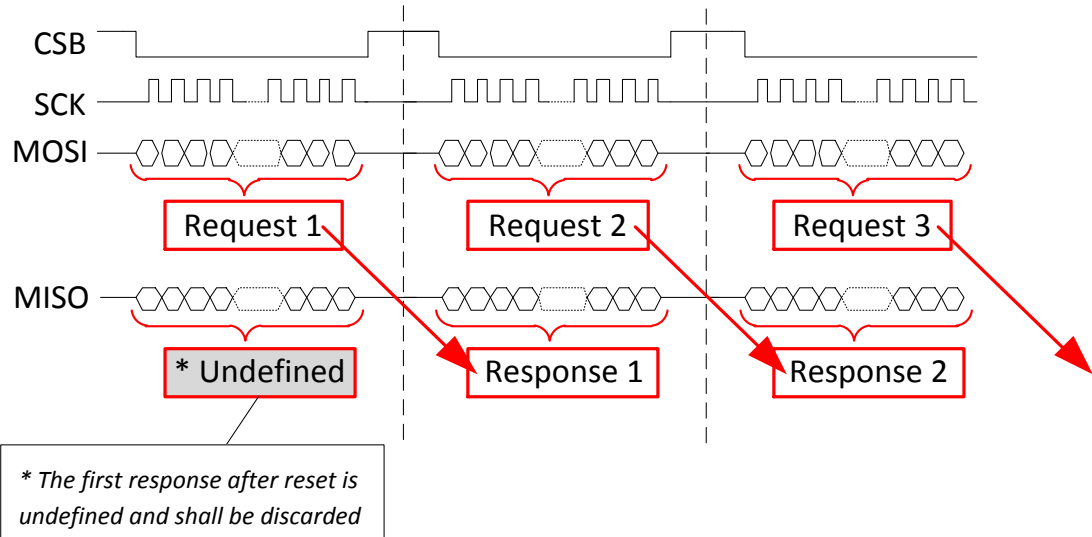

Figure 14. SPI Protocol

5.3 SPI Frame

SPI operating commands can be found in Table 13. Response frame has data bits and read status determined in Table 12.

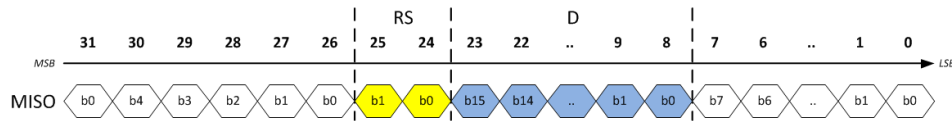

Figure 15 - SPI Frame

Table 12. SPI Frame Specification

Name	Description	MISO
RS	Return status ¹⁾	'00' - Startup in progress '01' - Normal operation, no flags '11' - Error
D	Data	Returned data

Return Status (RS) shows error (i.e. '11') when an error flag (or flags) is active in, or if previous MOSI-command was incorrect frame.

5.3.1 Operations

Table 13. Operations and their equivalent SPI frames.

Operation	SPI Frame	SPI Frame Hex
Read ACCX	0000 0100 0000 0000 0000 0000 1111 0111	040000F7h
Read ACCY	0000 1000 0000 0000 0000 0000 1111 1101	080000FDh
Read ACCZ	0000 1100 0000 0000 0000 0000 1111 1011	0C0000FBh
Read STO(self-test output)	0001 0000 0000 0000 0000 0000 1110 1001	0x100000E9
Read TEMP	0001 0100 0000 0000 0000 0000 1110 1111	140000EFh
Read Status Summary	0001 1000 0000 0000 0000 0000 1110 0101	180000E5h
SW reset	1011 0100 0000 0000 0010 0000 1001 1000	0xB4002098
Change to mode1	1011 0100 0000 0000 0000 0000 0001 1111	B400001Fh
Change to mode2	1011 0100 0000 0000 0000 0001 0000 0010	B4000102h
Change to mode3	1011 0100 0000 0000 0000 0010 0010 0101	B4000225h
Change to mode4	1011 0100 0000 0000 0000 0011 0011 1000	B4000338h
Read WHOAMI	0100 0000 0000 0000 0000 0000 1001 0001	40000091h

¹⁾ PRIORITY OF RETURN STATUS STATES FROM HIGHEST TO LOWEST IS: '00' -> '11' -> '01'

5.3.2 Status Explanation

Status summary contain more accurate information of possible error source. SW reset is done with SPI bus. HW reset means that to resolve error there is need to power cycling. If this does not reset the error then possible component error has occurred and system needs to be shutdown and part returned to supplier. Status summary explanations:

Status summary bits			
Bit	Name	Description	Note/Action
15:10	reserved	Not used	
9	digi1	Digital block error type 1	SW or HW reset needed
8	digi2	Digital block error type 2	SW or HW reset needed
7	clock	ASIC clock error	SW or HW reset needed
6	sat	Signal saturated in signal path	Acceleration too high and acceleration reading not usable. Component failure possible
5	temp	Signal saturated in temperature compensation	External temperature too high or low. Component failure possible
4	power	Voltage level failure	External voltages too high or low. Component failure possible
3	mem	Memory error	Memory check failed. SW or HW reset needed. Possible component failure.
2	digi3	Digital block error type 3	SW or HW reset needed
1	mode_change	Operation mode has changed	If mode change is not requested. SW or HW reset needed.
0	pin_continuity	Component internal connection error	Possible component failure.

5.4 Example of Acceleration Data Conversion

For example, if ACC_X read results: ACC_X = 0500DC02h, the content is converted to acceleration rate as follows:

05h = 000001 01b

01b = return status (RS bits) = no error

00DCh = bin 0000 0000 1101 1100b = ACC_X

00DCh in 2's complement format = 220d

Acceleration(Mode1) = 220LSB / sensitivity(mode1) = 220LSB/2700=0.081g=81mg

Mode1 sensitivity = 2700 LSB/g

Mode2 sensitivity = 1350 LSB/g

Mode3 and 4 sensitivity = 5400 LSB/g

5.5 Example of Temperature Data Conversion

For example, if TEMP read results: TEMP = 15161E4Eh, the content is converted to temperature as follows:

15h = bin 000111 01b

01 = return status (RS bits) = no error

161Eh = bin 0001 0110 0001 1110 = TEMP

FE6Fh in 2's complement format = 5662d

Temperature = -273 + (TEMP / 18.9) = -273 + [298/18.9] = +26.6°C

See section 2.3 for temperature conversion equation

5.6 Example of Self-Test Analysis

If Self-test data read results: **0500DC02h**, the content analyzed as follows:

05h = 000001 01b

01b = return status (RS bits) = no error

00DCh = bin 0000 0000 1101 1100b = self-test reading

00DCh in 2's complement format = 220d

If self-test readings are higher than 400d or lower than -400d, acceleration data read same time is not usable. If self-test output is not returned within requested limits there is possible component failure.

6 Application Information

6.1 Application Circuitry and External Component Characteristics

See Figure 16 and Table 14 for specification of the external components. The PCB layout example is shown in Figure 17.

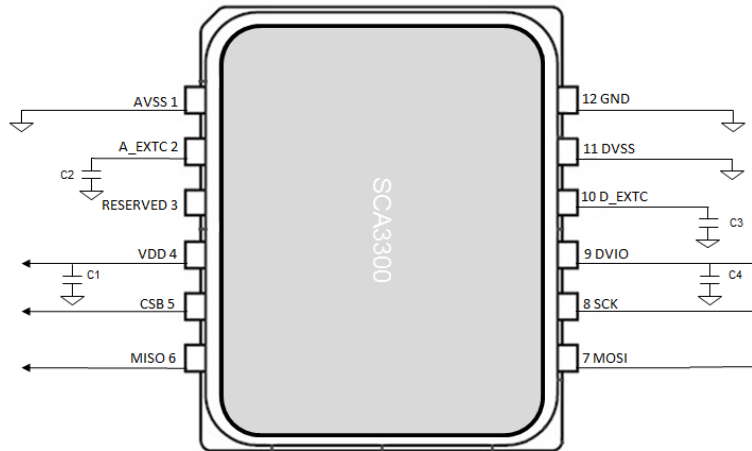

Figure 16. Application schematic.

Table 14. External component description for SCA3300-D01.

Symbol	Description	Min.	Nom.	Max.	Unit
C1	Decoupling capacitor between VDD and GND ESR Recommended component: Murata GCM188R71C104KA37, 0603, 100N, 16V, X7R	70	100	130 100	nF mΩ
C2	Decoupling capacitor between A_EXTC and AVSS ESR Recommended component: Murata GCM188R71C104KA37, 0603, 100N, 16V, X7R	70	100	130 100	nF mΩ
C3	Decoupling capacitor between D_EXTC and GND ESR Recommended component: Murata GCM188R71C104KA37, 0603, 100N, 16V, X7R	70	100	130 100	nF mΩ
C4	Decoupling capacitor between DVIO and GND ESR Recommended component: Murata GCM188R71C104KA37, 0603, 100N, 16V, X7R	70	100	130 100	nF mΩ

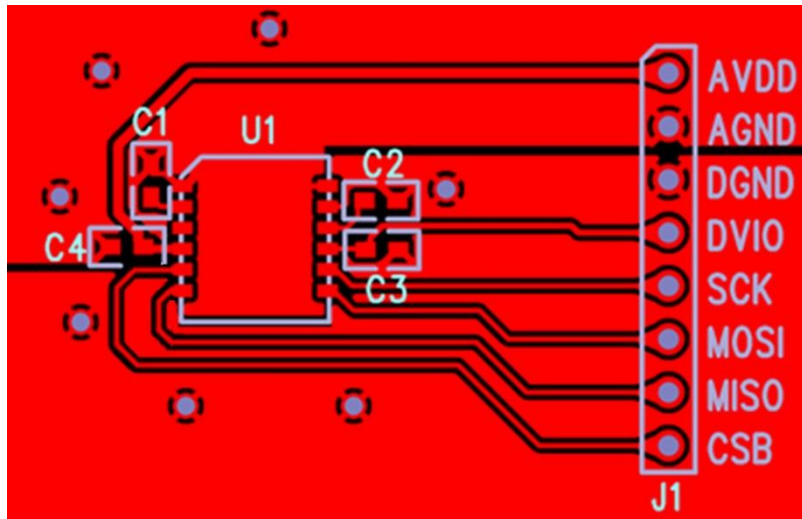

Figure 17. Application PCB layout.

General circuit diagram and PCB layout recommendations for SCA3300-D01 (refer to Figure 16 and Figure 17):

- Connect decoupling SMD capacitors (C1 - C5) right next to respective component pins.
- Locate ground plane under component.
- Do not route signals or power supplies under the component on top layer.
- Ensure good ground connection of DVSS, AVSS and EMC_GND pins

6.2 Assembly Instructions

The Moisture Sensitivity Level of the component is Level 3 according to the IPC/JEDEC JSTD-020C. The part is delivered in a dry pack. The manufacturing floor time (out of bag) at the customer's end is 168 hours.

Usage of PCB coating materials may penetrate component lid and affect component performance. PCB coating is not allowed.

Sensor components shall not be exposed to chemicals which are known to react with silicones, such as solvents. Sensor components shall not be exposed to chemicals with high impurity levels, such as Cl⁻, Na⁺, NO₃⁻, SO₄⁻, NH₄⁺ in excess of >10 ppm. Flame retardants such as Br or P containing materials shall be avoided in close vicinity of sensor component. Materials with high amount of volatile content should also be avoided.

If heat stabilized polymers are used in application, user should check that no iodine, or other halogen, containing additives are used.

For additional assembly related details please refer to Technical Note Assembly instructions of Dual Flat Lead Package (DFL). 82201500A_DFL Assembly instructions

Document Change Control

Authors	Approved by
Antti Viitanen Iivari Heikkilä	
Department/Role	
Product Division / Product Manager Product Division / Product Engineer	

Rev.	Date	Change Description	Author	Reviewed by	ECN
A0	29.9.2016	Preliminary release	ASV		
A1	3.11.2016	New outlook. Updated figures. Low-power mode removed.	ASV/IIHE		