

EMI FILTERS

CATALOG

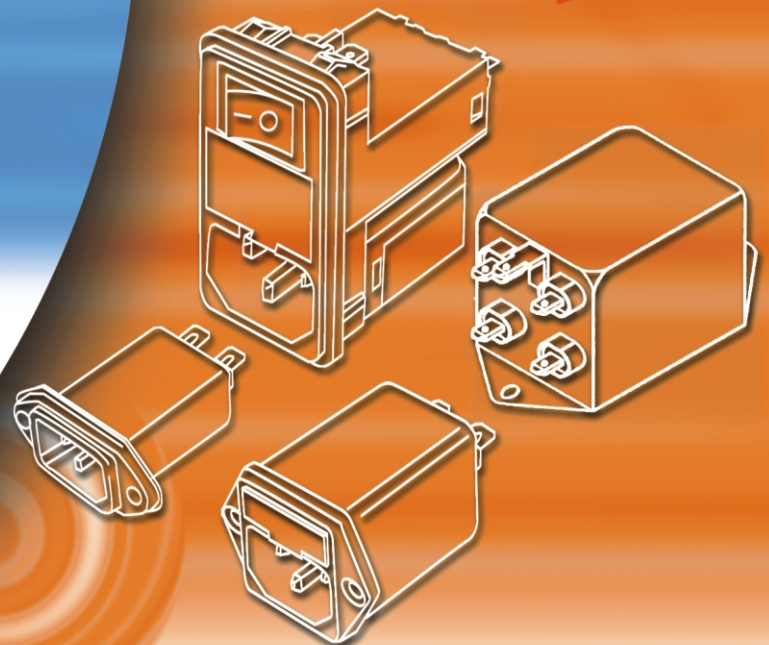



Quality Makes The Difference
ISO-9001 & ISO-14001 Approved

Table of Contents

Delta EMI Filters Introduction

Delta Strength & Capability in EMI/RFI Filters.....	1-1
Features and Benefits for OEM Users.....	1-3
Brief Concept of EMI Filter	1-4
Delta Part Numbering System	1-6

Series

IEC INLET FILTERS

15A DE Compact IEC Connector Filters	2-1
GE High Performance IEC Connector Filters	2-4
GE Snap-In Mounting High Performance IEC Connector Filters	2-7
GK Mounting High Performance IEC Connector Filters	2-9
GKN Snap-In Mounting High Performance IEC Connector Filters	2-10
KE High Performance IEC Connector Filters	2-11
KEN High Performance Snap-In Filters.....	2-12

IEC INLET PC BOARD MOUNTING FILTERS

ME PC Board Mounting Filters	3-1
------------------------------------	-----

POWER ENTRY MODULE FILTERS

AK Power Entry Module EMI Filters	4-1
AR Power Entry Module EMI Filters	4-3
BE Fuse Connector Filters	4-5
BE Dual-Fuse Connector Filters	4-6
BE Switch Connector Filters.....	4-7
EB Power Entry Module EMI Filters	4-8
EK High Performance Power Entry Module EMI Filters	4-10
NB & SB Compact IEC Connector Filters	4-12
IB Power Entry Module EMI Filters	4-15

GENERAL PURPOSE ONE-STAGE FILTERS

DB General Purpose Filters	5-1
DK General Purpose Filters	5-6
MK High Performance PC Board Mounting Filters	5-11

GENERAL PURPOSE TWO-STAGE FILTERS

DP Switching Transient Filters	6-1
DC Switching Transient Filters	6-5
DR High Performance Filters	6-7
DS Multi-Purpose Power Line Filters	6-10
DV Multi-Purpose Power Line Filters	6-12
DW Multi-Purpose Power Line Filters	6-14

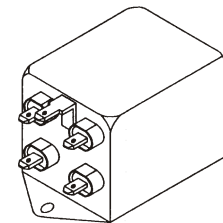
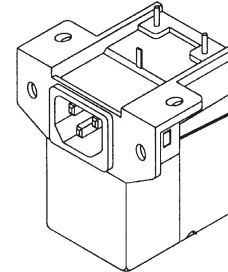

MEDICAL FILTER

Medical Filters	7-1
-----------------------	-----

IEC CONNECTORS

Screw Mounting	8-1
Snap-In Mounting	8-3
PC Board and Screw Mounting	8-4

POWER ENTRY MODULES

Snap-In Mounting	8-5
Screw & Snap-In Mounting	8-8

THREE-PHASE FILTERS

TD 3-Phase, 3-Wire Filters	9-1
TDH Low Voltage 3-Phase, 3-Wire Filters.....	9-2
TDR Vertical 3-Phase, 3-Wire Filters.....	9-3
TDS General 3-Phase, 3-Wire Filters	9-5
TDS High Current 3-Phase, 3-Wire Filters	9-7
TDT High Performance 3-Phase, 3-Wire Filters	9-8
TDV 3-Phase Filters	9-9
TY Compact 3-Phase, 4-Wire Filters	9-10
TYS 3-Phase, 4-Wire Filters	9-11
TYS High Current 3-Phase 4-Wire Filters	9-12
TYT High Performance 3-Phase, 4-Wire Filters	9-13
TDT & DRT EMI Filter For Inverters	9-14
PT&PY 3-Phase P.C.B. Filters.....	9-16

GENERAL PURPOSE ONE-STAGE FILTERS

MB High Performance Cylindrical Filters	10-1
---	------

The data contained in this catalogue is intended to be a general product description.

DELTA reserves the right to make changes in specifications without notice.

Please contact us for custom designs.

Delta Strength and Capability

TECHNOLOGY & TECHNICAL SERVICE

Since 1981, Delta has been producing reliable, quality consistent, dependable EMI filters that cater to power supplies, monitors, instruments, networking and medical equipments, and many other devices around the world. Our extensive years of experience have made us the prime leader of these product. We have flexible engineering and supporting groups that enable us to provide solutions to our customer's problems in a timely manner. And with our very own international recognized test facilities such as shielding rooms and anechoic chamber, test for total EMC compatibility can be done and certified right away. Our technical expertise is demonstrated by over 1000 standard part numbers that are approved with UL, CSA and VDE.

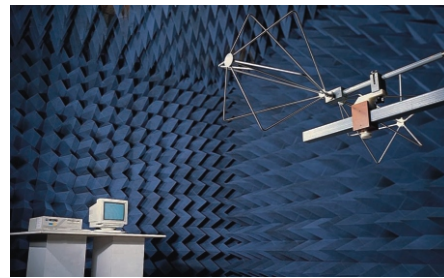

EMI/RFI Shielding Room

QUALITY

Delta's commitment to quality can be summed up in the numerous awards we have received from major world-class leaders such as Dell, HP, IBM, NEC, Sony, Fujitsu, Intel, GE and many others. All our EMI/RFI Filters meet international safety standards and have undergone Statistical Process Control and Total Quality Control before mass production. Our full commitment in quality starts from the design stage and continues through the production stages. All Delta plants are certified with ISO-9000/ISO-14001 and our EMI/RFI filter plant has been qualified under the IECQ system.



MANUFACTURING

Delta's manufacturing base for EMI/RFI filters is located within all our ISO-14001 certified Thailand plants. State-of-the-art automation equipments have been installed in these plants and through this, we are able to greatly increase our production capacity and maintain a consistent quality level for our products. Our automation equipment includes automated winding, assembly and test systems. All these systems are developed and produced by our own automated engineering department. To assure our clients of a continuous supply of stock all year round, our global operation with sales and marketing are located in key cities around the world.



Manufacturing Plant in Thailand



Marketing and R&D in Taoyuan, Taiwan



Automated Assembly Line

PRODUCT OFFERING

Delta has been moving forward with continual product improvement. Our three-phase filters with maximum amperes of 600A and voltage rating of up to 520 VAC are presently in mass production, and have been used to a large extent in AC motor drives and machine tool applications. In the meantime, development of high frequency products for telecom & networking market are underway.

Our present products covers IEC inlet filters with a maximum of 20A, chassis mounting filters with maximum of 60A and the three-phase filters. Thanks to our long experience working with multi-national companies, we have the capability to deliver customized products within a short period of time, whatever the quantity is. Our facilities, experience, services, compounded with the latest technology are there to offer EMI filters to meet our customers' utmost satisfaction.

FEATURES AND BENEFITS FOR OEM USERS

1. UL, CSA, VDE/ TUV, SEV, SEMKO, DEMKO AND SETI Safety Standards

All Delta filters are designed to meet UL standard 1283, CSA STANDARDS C22.2 No.0, No.8, and VDE STANDARD EN60939-2, including conformity to temperature range (-25°C to +100°C) and full current rating usage at both 115 VAC and 250 VAC. All filters in this catalog are UL recognized and CSA certified, and over 1000 types are VDE approved under the following file numbers:

UL file no. E79109

CSA file no. LR48852C

VDE file no. 11641-4730 or SEMKO.

2. FCC and VDE Emission Compliance

Delta offers a wide range of filter characteristics, both in standard and custom form, to help you meet all applicable FCC, VDE and VCCI conducted emission standards, including FCC, VDE and VCCI class B requirements.

3. Construction and Design

- ① - Toroid cover for perfect insulation, with built-in spacers to maintain creepage distance between windings.
- ② - Precision balance of inductance between windings to prevent core saturation at full load.
- ③ - Only capacitors that comply with VDE 0565-1 are used.
- ④ - Low leakage current.
- ⑤ - Both crimped and soldered connections.
- ⑥ - Anti-rotation terminals to prevent open connections.
- ⑦ - Corrosion-proof case.

4. Quality Control

- 100% tested for Hipot, leakage current and insertion loss.
- Less than 200 parts-per-million (ppm) defect rate.
- Approved for Ship-to-Stock program (no incoming inspection) at major computer manufacturers' facilities.

5. Availability

Stock of standard items are maintained in Northern California for immediate shipment to OEM customers and at distributors located throughout North America.

6. Price

Delta filters are very competitively priced due to highly automated lines and cost-saving designs.

7. Custom Design and Testing Services

Delta has engineering labs and shield rooms in Taipei and Northern California. These facilities allow us to design and fabricate custom filters to meet special requirements not met by standard filters and to test customers' equipment for compliance to FCC, VDE and VCCI conducted emission requirements.

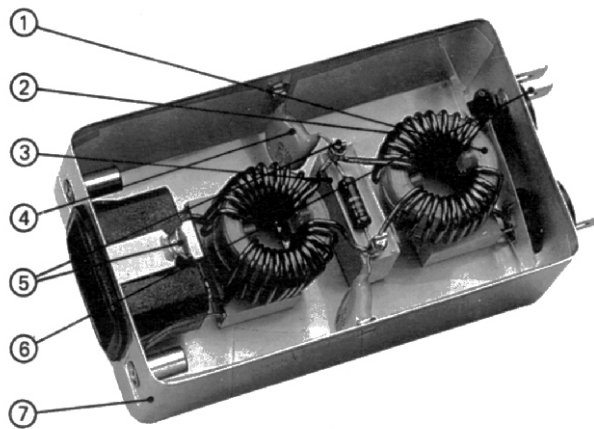

BRIEF CONCEPT OF EMI FILTER

◆ EMI NOISE-ORIGIN AND CHARACTERISTICS

Recent decades have witnessed the rapid growth of computers, business machines, industrial controls, medical electronic equipment and many other devices that utilize digital techniques. Concurrent with this growth, the problems of Electro-Magnetic Interference (EMI) found both in the equipment, causing equipment malfunction, and outside of the equipment, causing interference to other equipment of related Emission communication, have become more severe. The frequency ranges of EMI noise are 10KHz to 30MHz by conduction through wires and 30MHz to 1GHz by radiation.

Conducted EMI noise consists of two modes:

1. Common mode interference is EMI noise present on the line and neutral referenced to safety ground. Most noise problems are caused by common mode interference.
2. Differential mode interference is EMI noise present on the phase line referenced to the neutral. Differential mode EMI tends to decline rapidly in the building wiring.

◆ VDE

Products intended for European markets should meet the requirements devised by VDE. VDE 0243 specification limits conducted emission for computing devices and other industrial, scientific and medical equipment to two levels:

Class A:

The user has to apply for a special operating license issued by the BZT (the German equivalent of FCC). If the equipments moved from one location to another, the BZT must be notified.

Class B:

If the equipment meets the B level, it then has general approval and no operating license is required. Most manufacturers attempt to meet Class B for marketing reasons. Conducted EMI regulated by FCC part 15 and VDE 243 are shown in the figure below.

◆ LEGAL REGULATION ON CONDUCTED EMI FCC

In the US, the FCC has imposed legal regulations to control interference at its source. All computing devices, including peripherals, using digital techniques with a clock frequency greater than 10KHz must comply with FCC regulations part 15 after Oct. 1983.

The FCC had divided products into two basic categories:

Class A:

For computing devices marketed for use in a commercial, industrial or business environment. Class A requires verification, which means that the equipment has been tested and complies with the data.

Class B:

For computing devices marketed for use in a residential environment. Class B requires certification, which means that the test data has to be submitted to FCC for the equipment to pass.

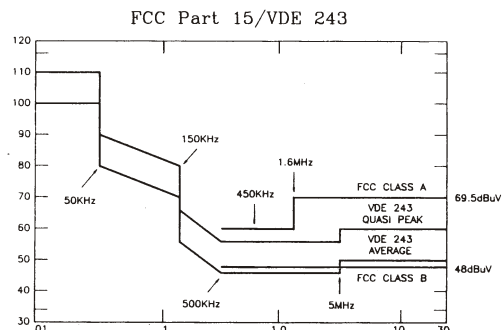

◆ ADEQUATE SELECTION OF EMI FILTER

The effectiveness of noise attenuation is undoubtedly the primary concern for selecting an EMI filter. The capability in this aspect usually refers to the reading of insertion loss which is derived from following formula:

$$\text{Insertion loss (dB)} = 20 \log \frac{V_1}{V_2}$$

Wherein V_1 = EMI voltage without filter

V_2 = EMI voltage with filter

Published insertion loss data assumes that power line and load have the same impedance and all such data are in practice generated from a 50 OHM-50 OHM circuit. However, the said condition seldom exists in actual application. Therefore, insertion loss readings are not supposed to represent actual performance of noise suppression but a reference for comparison among different units or evaluation of product conformity in incoming inspection. To verify actual effectiveness in noise suppression, a filter has to be mounted in the equipment and be subjected to conduct emission test in a shielding room.

The effectiveness of noise attenuation depends heavily on the source and load impedance. EMI filter function as "mismatching networks" between source and load impedance at high frequencies. The greater the mismatch, the more effective the filter will be in attenuating the interference. In most cases, the power line presents low impedance. The filter line side should then present high impedance. Equipment, on the other hand, can be either high or low impedance. High impedance equipment such as linear power supplies should use a filter with low impedance or a shunt capacitor at the load side to create a mismatch. Low impedance equipment such as switching power supplies, synchronous motors or shunt regulators should use a filter with high impedance at the load side and should have a series inductor. The schematics below provide you an easy way for choosing the appropriate filter.

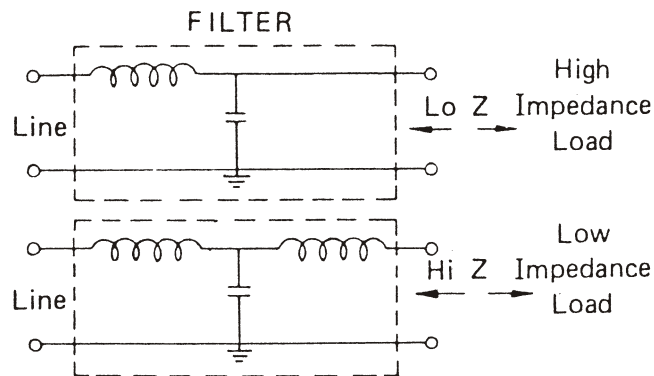

The following factors should also be taken into consideration in your selection process.

- Current and voltage rating
- Environment requirement such as temperature, shock, vibration and humidity
- Physical dimension and terminal configuration
- Availability
- Cost effectiveness
- Safety approval

DELTA PARTS NUMBERING SYSTEM

MODELS OTHER THAN POWER ENTRY MODULE TYPES AND P.C. BOARD MOUNTING TYPES

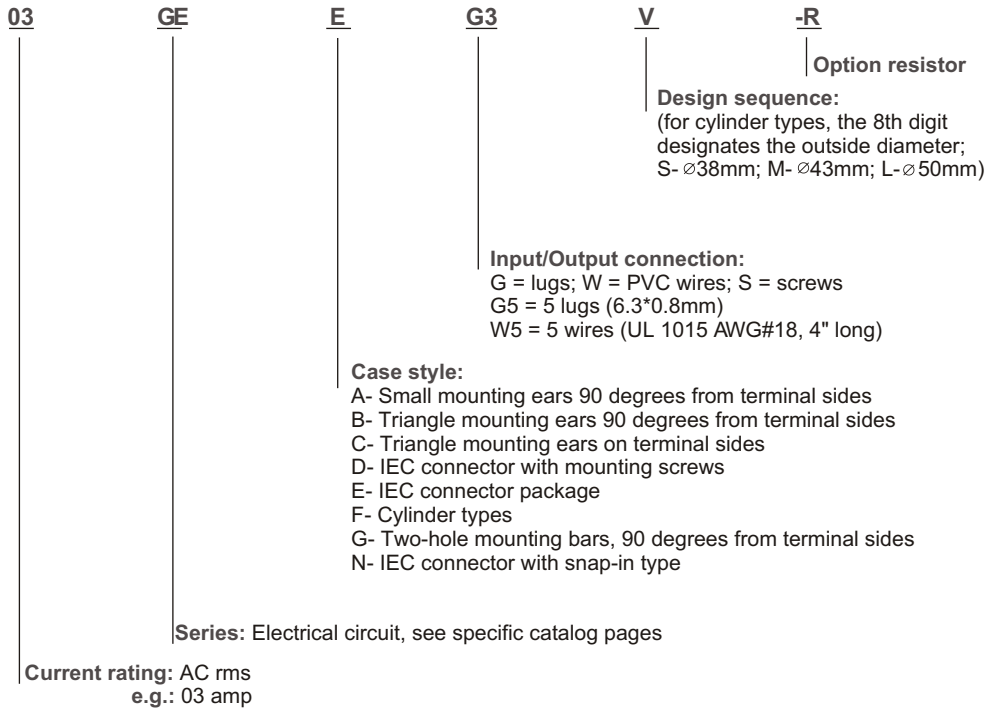

POWER ENTRY MODULE TYPES

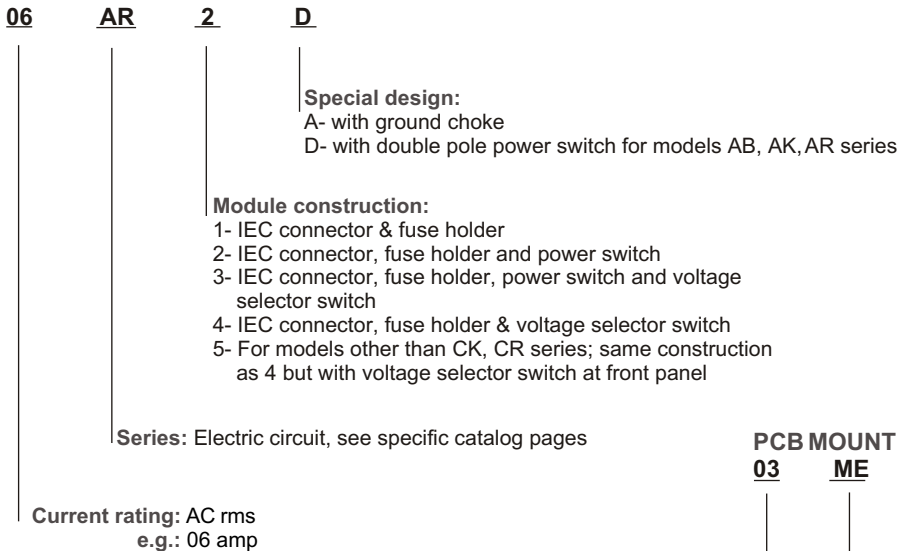

PCB MOUNTING TYPES

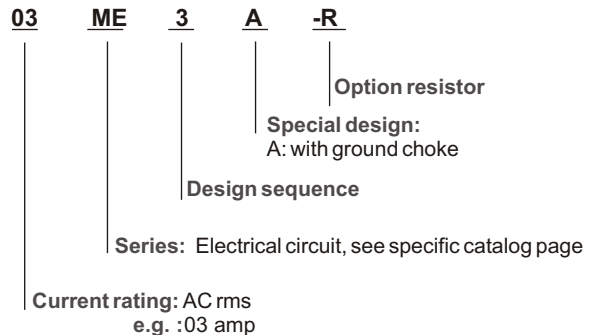

DELTA PARTS NUMBERING SYSTEM

3-Phase Types

10

TD

S6

D

Current rating: AC rms
e.g.: 10 amp

Series:

- TD: used in "Δ" system
- TDH: used in "Δ" system
- TDR: used in "Δ" system, vertical style
- TDV: used in "Δ" system, vertical style
- TDS: used in "Δ" system, screw style
- TY: used in both "Δ" & "y" system
- TYS: used in "Δ" & "y" system, screw style
- TYT: used in "Δ" & "y" system terminal block style
- PT: P.C.B. Filter
- PY: P.C.B. Filter

Input/Output connection :

- G = lugs; W = PVC wires; S = screws; T = terminal blocks
- e.g.
- G6 = 6 lugs
- W6 = 6 wires
- T2: 2 terminal blocks
- TIW4: 1 terminal block / 4 wires

Special Design:

Dual: diff. and common choke





15A DE SERIES

COMPACT IEC CONNECTOR FILTERS



INTRODUCTIONS

- 15DEEG3X: Filter with 120°C temperature socket
- 15DEEG3X(D): Filter with 65°C temperature socket
- Safety Approval:
 EG3HA/(D): UL, CSA,
 EG3E/(X)/(DX):
 EG3M(D):
 EG3HAX/(X)/(DX): UL, CSA, VDE
 EG3E-R/(X)/(DX):
 • (X): (1), (2), (3)
- UL, CSA approved 15A at 115VAC & 250VAC;
 VDE-10A at 250 VAC

COMPONENTS

PART NO.	Cx (uF)	Lg (uH)	L (mH)	
15DEEG3HA/(D)	—	6	0.12	
15DEEG3HAX/(D)	0.1			
15DEEG3HAX(2)/(D)	0.033			
15DEEG3HAX(3)/(D)	0.047			
15DEEG3E-R/(D)	0.1	—		0.15
15DEEG3E-R(1)/(D1)	0.0047			
15DEEG3E-R(2)/(D2)	0.033			
15DEEG3E-R(3)/(D3)	0.047			
15DEEG3E/(D)	0.1			
15DEEG3E(1)/(D1)	0.0047			
15DEEG3E(2)/(D2)	0.033			
15DEEG3E(3)/(D3)	0.047			
15DEEG3M(D)	0.1		—	0.15
15DEEG3M(D2)	0.033			
15DEEG3M(D3)	0.047			

SPECIFICATIONS

- Maximum leakage current each
 line-to-ground @ 115VAC 60Hz: 0.20mA
 @ 250VAC 50Hz: 0.40mA
- Hipot rating (one minute)
 line-to-ground: 2250VDC
 line-to-line: 1450VDC
- Operating frequency: 50/60Hz
- Rated voltage: 115/250VAC

ELECTRICAL SCHEMATIC

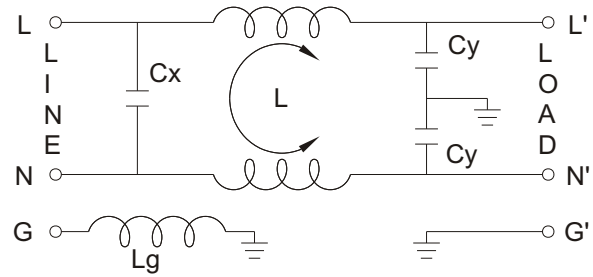
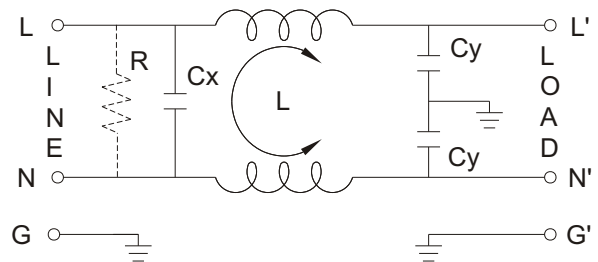

FIG. A: 15DEEG3HAX(X)/(DX)
 Cy: 2200pF



15DEEG3E-R(X)/(DX)
 FIG. B: 15DEEG3E(X)/(DX)
 15DEEG3M(X)/(DX)

R: 1M
 Cy: 2200pF

◆15DE Series P/N System

15DE Series has different combinations on socket and Cx, please see the following:

A: SOCKET

- EX. P/N: 15DEEG3E used socket (FIG. A).
- EX. P/N: 15DEEG3E(D), P/N with suffix: "(D)" used socket (FIG. B).

B. Cx

- EX. P/N: 15DEEG3E Cx: 0.1uF
- P/N with suffix "(1)" & "(D1)" Cx: 0.0047uF
- P/N with suffix "(2)" & "(D2)" Cx: 0.033uF
- P/N with suffix "(3)" & "(D3)" Cx: 0.047uF

15DEEG3E

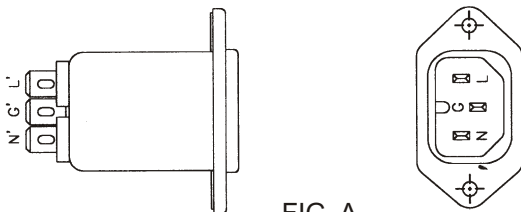

FIG. A

15DEEG3E (D)

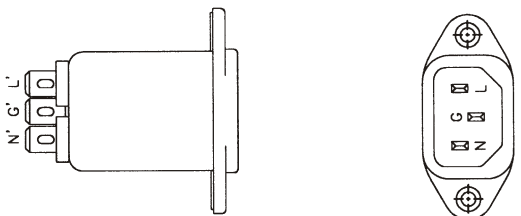

FIG. B

MINIMUM INSERTION LOSS IN dB

COMMON MODE (L-G) IN 50 OHM SYSTEM							DIFFERENTIAL MODE (L-L) IN 50 OHM SYSTEM								
PART NO.	FREQUENCY-MHz						PART NO.	FREQUENCY-MHz							
	.10	.15	.50	1.0	5.0	10		30	.10	.15	.50	1.0	5.0	10	30
15DEEG3E(D)/-R	1	2	8	10	20	25	40	15DEEG3E(D)/-R	1	2	10	15	25	25	40
15DEEG3E(D1)/-R		0	5	10	20	25	40	15DEEG3E(D1)/-R		0	0	1	3	30	40
15DEEG3E(D2)/-R	1	2	8	10	20	25	40	15DEEG3E(D2)/-R	0	1	5	8	20	30	40
15DEEG3E(D3)/-R	1	2	8	10	20	25	40	15DEEG3E(D3)/-R	0	1	5	10	20	30	40
15DEEG3HAX(D)	1	3	8	10	20	25	40	15DEEG3HAX(D)	1	4	10	20	15	20	25
15DEEG3HAX(D2)	1	3	8	10	20	25	40	15DEEG3HAX(D2)		0	4	10	15	25	35
15DEEG3HAX(D3)	1	3	8	10	20	25	40	15DEEG3HAX(D3)	0	1	7	15	15	20	35
15DEEG3M(D)	1	2	7	10	20	25	40	15DEEG3M(D)	1	4	10	10	20	20	35
15DEEG3M(D2)		2	6	10	20	25	35	15DEEG3M(D2)		0	5	8	25	20	35
15DEEG3M(D3)		1	6	10	20	25	35	15DEEG3M(D3)		1	8	10	20	25	35
15DEEG3HA(D)		1	5	10	20	28	35	15DEEG3HA(D)					1	8	30

INSERTION LOSS (TYPICAL)

15DEEG3E(D1) ----- COMMON MODE ----- DIFF. MODE
 15DEEG3E(D3) ----- COMMON MODE ----- DIFF. MODE

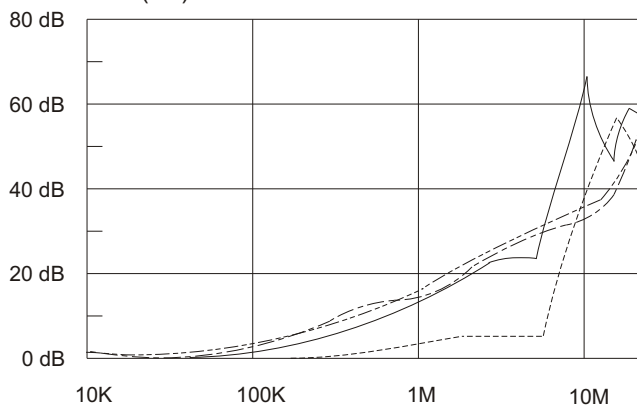

15DEEG3E(D2) ----- COMMON MODE ----- DIFF. MODE
 15DEEG3M(D2) ----- COMMON MODE ----- DIFF. MODE

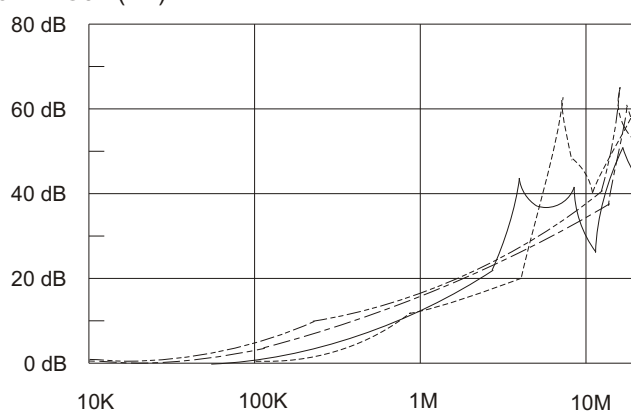

15DEEG3M(D) ----- COMMON MODE ----- DIFF. MODE
 15DEEG3HAX(D) ----- COMMON MODE ----- DIFF. MODE

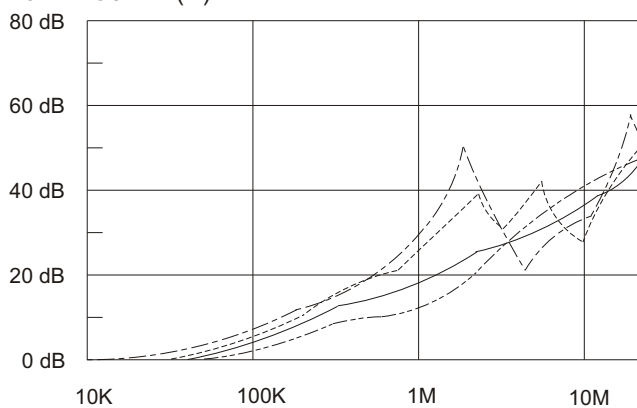

15DEEG3M(D3) ----- COMMON MODE ----- DIFF. MODE
 15DEEG3HAX(D3) ----- COMMON MODE ----- DIFF. MODE

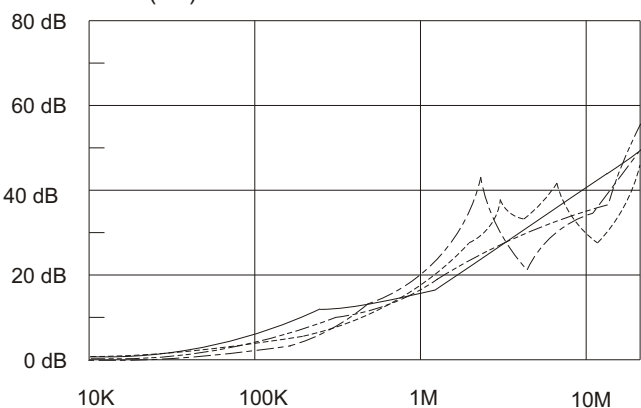

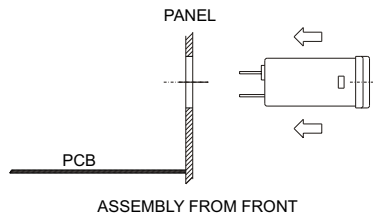

MECHANICAL CONSTRUCTION



EG3HA, EG3HAX(X)
EG3E-R(X), EG3E(X)

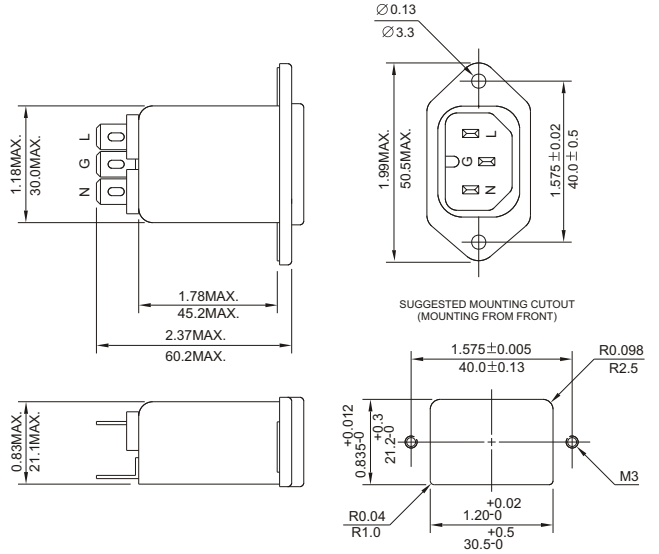

EG3HA(D), EG3HAX(D)
EG3E(D), EG3E-R(D)

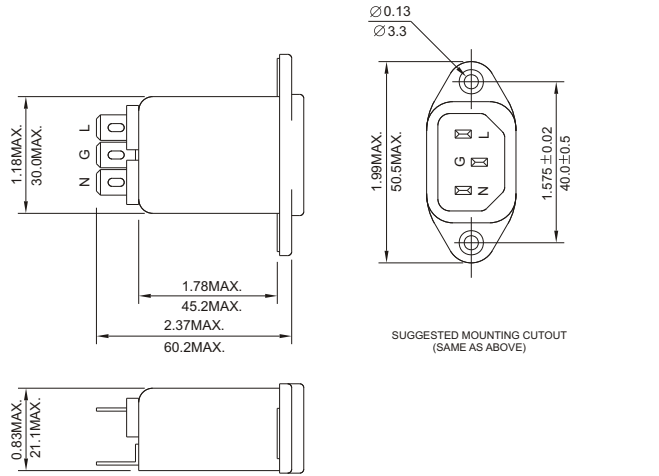

EG3M(D)

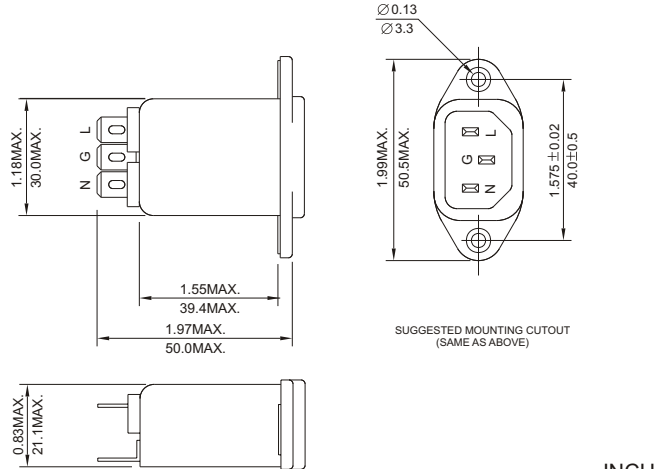

UNIT: INCH
mm



GE SERIES

HIGH PERFORMANCE IEC CONNECTOR FILTERS



INTRODUCTIONS

1. A high performance general purpose filter with an IEC connector providing effective EMI suppression.
2. Bleeder resistor can be added with suffix "-R" on part numbers, except "G3H", "G3V", "W3V", "G3J", "W3J", types.
3. All part numbers are UL recognized, CAS certified and VDE approved.
4. With optional Y-Cap from 100pF to 3300pF.
5. Safety under apply for 03/06/10GEEG3U series.

COMPONENTS

PART NO.	Cx (uF)	L (mH)	Cy (pF)	R (Ω)
01GEEG3E/W3E/-R	0.1	6.5	2200	1M
01GEEG3H/G3V/W3V		3	3300	-
01GEEG3S/-R		10.5	-	-
03GEEG3E/W3E/W3ES/G3U/-R		2.5	2200	1M
• 03GEEW3ES/-R				
03GEEG3H/G3V/W3V		4	3300	-
03GEEG3S/-R				
• 03GEEW3Q/W3Q-R		2.4	2200	1M
03GEEW3J				
03GEEH3J		0.8	3300	-
06GEEG3E/W3E/W3ES/G3U/-R				
06GEEG3H/G3V/W3V		1.05	-	-
06GEEG3S/-R				
•• 06GEEG3Q/W3Q-R		1.5	-	-
••• 10GEEG3C/W3C/-R		0.4	-	-
10GEEG3E/W3E/W3ES/G3U/-R		0.2	2200	1M
10GEEG3S/-R				
* 10GEEG3Q/W3Q-R		0.3	-	-
** 15GEEG3E/W3E/-R		0.2	-	-
*** 20GEEG3E/W3E/-R		0.3	-	-

- UL, CSA approved to 4A 115/250V
- UL, CSA approved to 8A 115/250V
- VDE approved to 8A/250V

- * UL, CSA approved to 13A 115/250V
- ** VDE approved to 10A/250V
- *** VDE approved to 16A/250V

SPECIFICATIONS

1. Maximum leakage current each line-to-ground @ 115VAC 60Hz: 0.25mA @ 250VAC 50Hz: 0.45mA
2. Hipot rating (one minute) line-to-ground: 2250VDC line-to-line: 1450VDC
3. Operating frequency: 50/60Hz
4. Rated voltage: 115/250VAC

ELECTRICAL SCHEMATIC

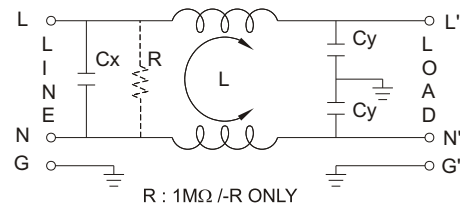

INSERTION LOSS (TYPICAL)

03GEEG3E ----- COMMON MODE ----- DIFF. MODE
 06GEEG3E ----- COMMON MODE ----- DIFF. MODE

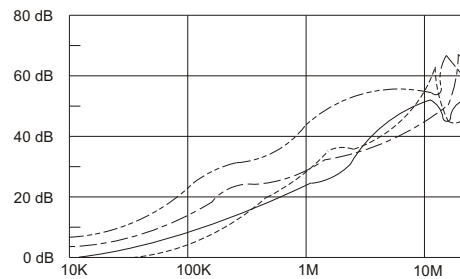

20GEEG3E ----- COMMON MODE ----- DIFF. MODE

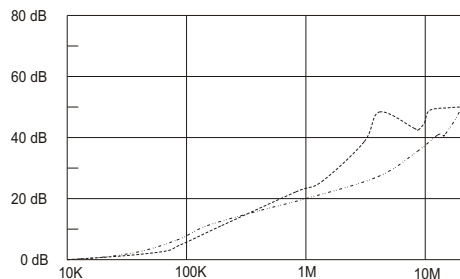

MINIMUM INSERTION LOSS IN dB

CURRENT RATING	COMMON MODE (L-G) IN 50 OHM SYSTEM					
	FREQUENCY-MHz					
	.15	.50	1.0	5.0	10	30
1A(E)(S)	28	35	38	38	40	40
1A(H)	26	36	44	54	55	55
1A(G3V)	24	35	42	50	55	55
1A(W3V)	24	35	42	50	55	55
3A(E)(S)(Q)	20	25	30	38	40	40
3A(H)	24	30	38	50	55	40
3A(G3J, W3J)	20	25	30	38	40	40
3A(G3V)(W3V)	20	29	36	48	46	50
6A(E)(S)	12	18	24	35	40	40
6A(H)	15	25	28	35	45	45
6A(Q)	15	20	24	35	40	55
6A(G3V)(W3V)	14	23	30	42	45	50
10A(E)(S)	4	10	13	28	35	40
10A(C)	10	15	15	25	30	35
10A(Q)	10	12	15	30	32	45
15A(E)	4	10	13	28	35	40
20A	8	10	15	25	30	35

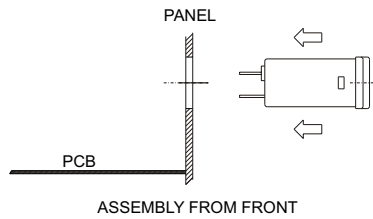

MECHANICAL CONSTRUCTION



EG3E, EG3Q (Optional soldering lug or wire type)

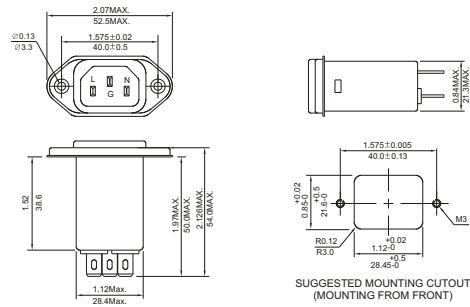

EG3S

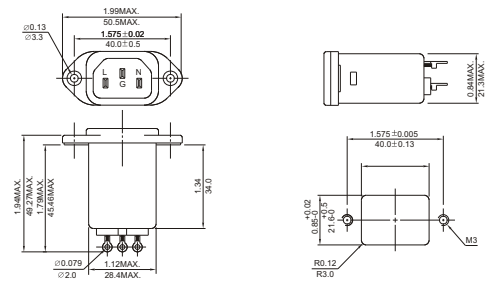

EG3U (With Compact Size)

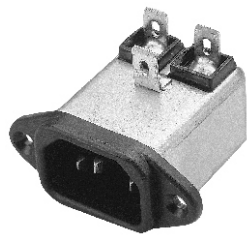
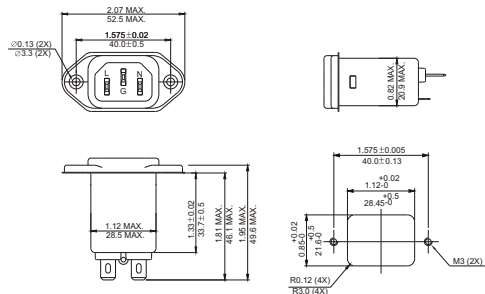

EG3V

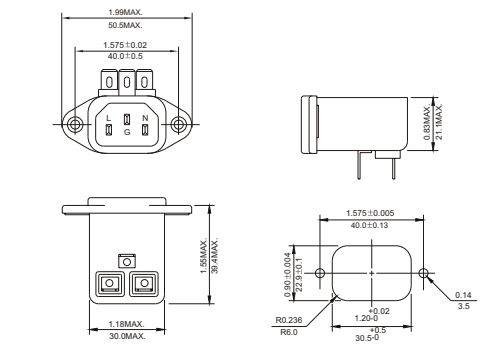

EW3V

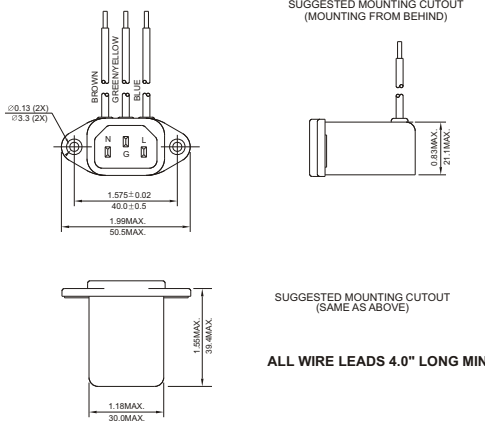

SUGGESTED MOUNTING CUTOUT (SAME AS ABOVE)

ALL WIRE LEADS 4.0" LONG MIN.

UNIT: INCH
mm

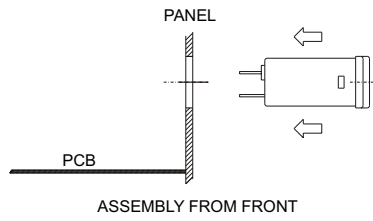

MECHANICAL CONSTRUCTION

EW3J

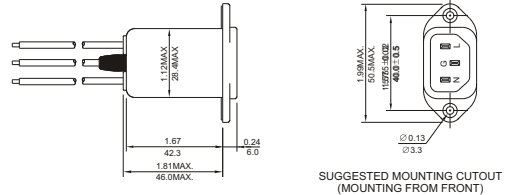

EW3ES

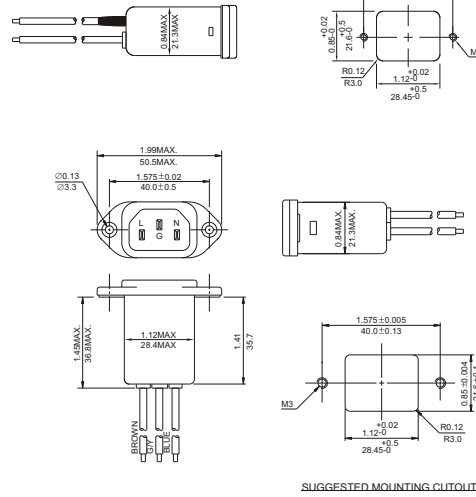
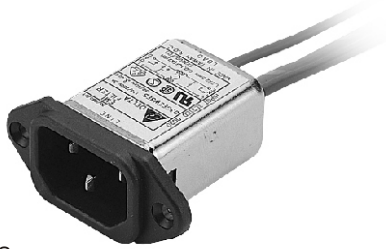

HG3J

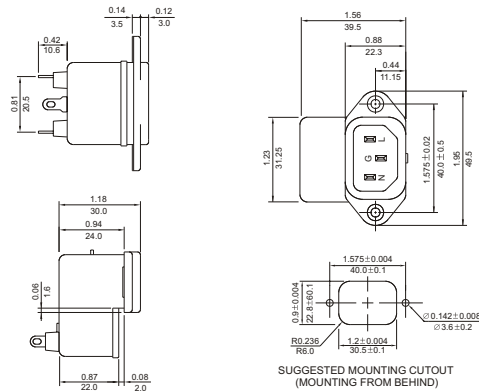
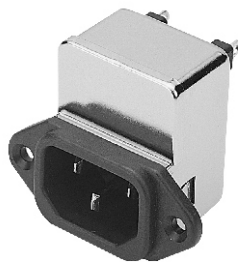

20GEEG3E (Optional wire type)

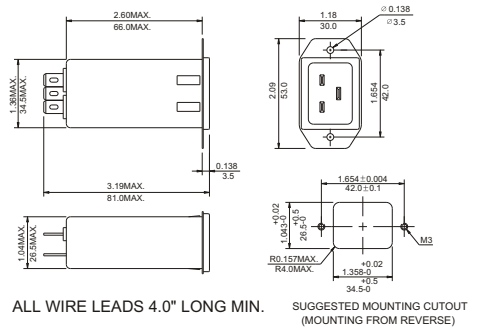

ALL WIRE LEADS 4.0" LONG MIN.

UNIT: $\frac{INCH}{mm}$



GE SERIES

SNAP-IN MOUNTING HIGH PERFORMANCE IEC CONNECTOR FILTERS



INTRODUCTIONS

1. Snap-in mounting type to reduce labor cost. Compact and reliable at low cost.
2. Bleeder resistor can be added with suffix "-R" on part numbers, except G3H, G3V, W3V, G3J, W3J, types.
3. Optional side snap-in mounting clip type with suffix (H) on part numbers.
4. All part numbers are UL recognized, CSA certified and VDE approved.
5. With optional Y-Cap from 100pF to 3300pF.
6. Safety under apply for 03/06/10GENG3U series.

COMPONENTS

PART NO.	Cx (uF)	L (mH)	Cy (pF)	R (Ω)
01GENG3E/W3E/-R	0.1	6.5	2200	1M
03GENG3E/W3E/G3U/-R		2.5		
• 03GENW3ES/-R		2.5		
• 03GENG3Q/W3Q/-R		4		
06GENG3E/W3E/G3U/-R		0.8		
•• 06GENG3Q/W3Q/-R		1.5		
06GENW3ES/-R		0.8		
10GENG3E/W3E/G3U/-R		0.2		
••• 10GENG3C/W3C/-R		0.4		
* 10GENG3Q/W3Q/-R		0.3		
10GENW3ES/-R		0.2		
** 15GENG3E/W3E/-R		0.2		
*** 20GENG3E/W3E/-R		0.3		

- UL, CSA approved to 4A 115/250V
- UL, CSA approved to 8A 115/250V
- VDE approved to 8A/250V

- * UL, CSA approved to 13A 115/250V
- ** VDE approved to 10A/250V
- *** VDE approved to 16A/250V

MINIMUM INSERTION LOSS IN dB

CURRENT RATING	COMMON MODE (L-G) IN 50 OHM SYSTEM					
	FREQUENCY-MHz					
	.15	.50	1.0	5.0	10	30
1A	28	35	38	38	40	40
3A	20	25	30	38	40	40
6A	12	18	24	35	40	40
6A (G3Q)	15	20	24	35	40	55
10A	4	10	13	28	35	40
10A (G3C)	10	15	15	25	30	35
10A (G3Q)	10	12	15	30	32	45
15A	4	10	13	28	35	40
20A	8	10	15	25	30	35

ELECTRICAL SCHEMATIC

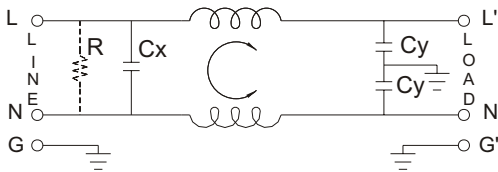

SPECIFICATIONS

1. Maximum leakage current each line-to-ground @ 115VAC 60Hz: 0.2mA @ 250VAC 50Hz: 0.4mA
2. Hipot rating (one minute) line-to-ground: 2250VDC line-to-line: 1450VDC
3. Operating frequency: 50/60Hz
4. Rated voltage: 115/250VAC

INSERTION LOSS (TYPICAL)

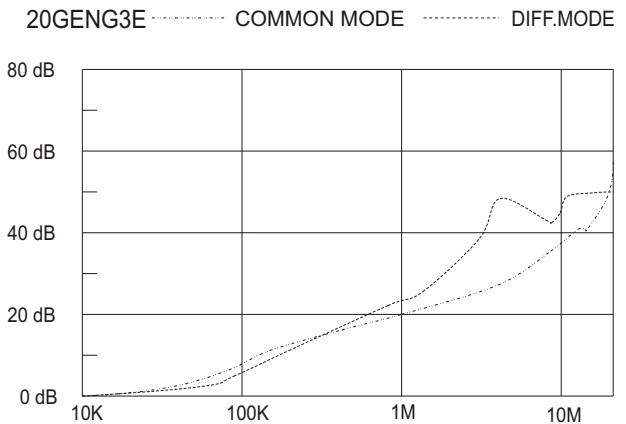
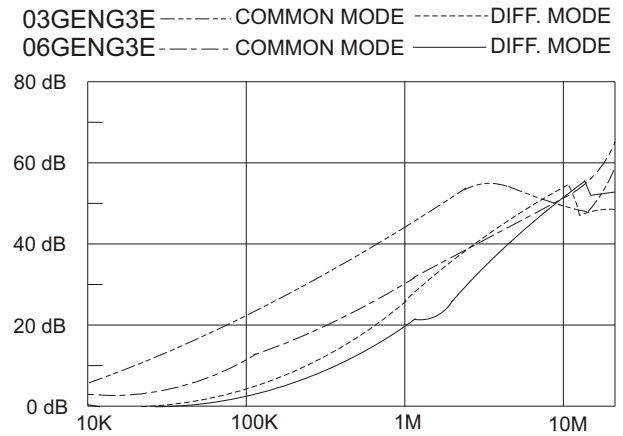

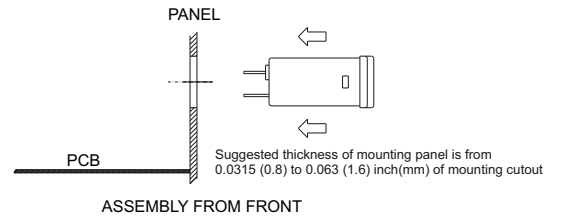

MECHANICAL CONSTRUCTION



NG3E, NG3C, NG3Q (Optional wire type)

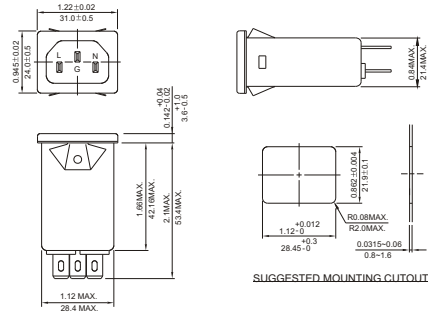

GENG3E



NG3E(H), NG3C(H), NG3Q(H) (Optional wire type)

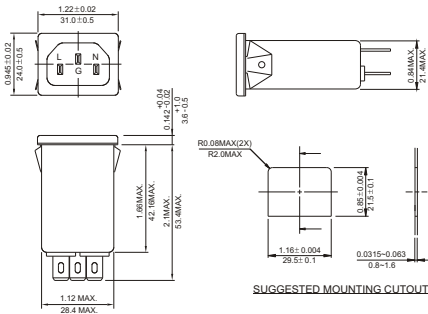

GENG3E(H)



NG3U (With Compact Size)

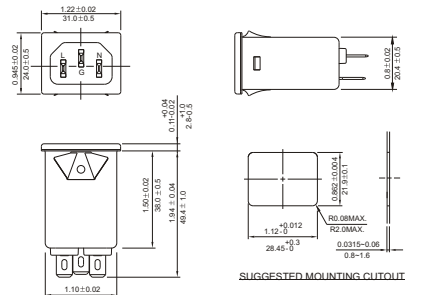

NG3U

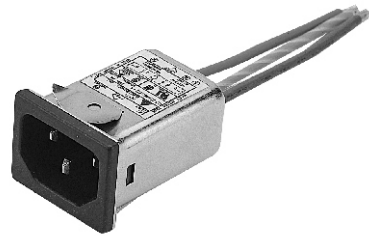

NW3ES

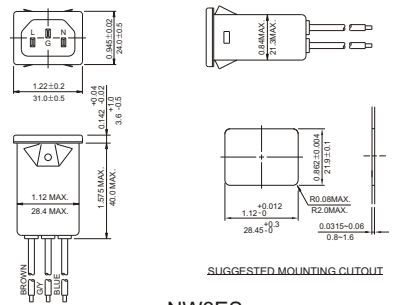

NW3ES



20GENG3E (Optional wire type)

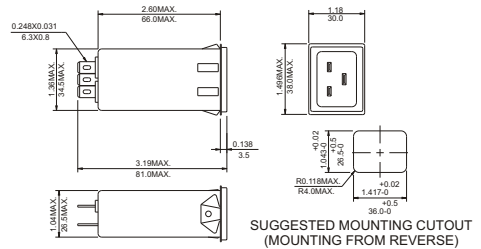

UNIT: INCH
mm



GK SERIES

MOUNTING HIGH PERFORMANCE IEC CONNECTOR FILTERS



INTRODUCTIONS

1. Specially designed with additional X capacitor providing most effective EMI suppression for low frequency noise (ranged 150KHz-500KHz).
2. Bleeder resistor can be added with suffix "-R" on part numbers.
3. With optional Y capacitor from 100pF to 3300pF.
4. All part numbers are UL recognized, CSA certified and VDE approved.

SPECIFICATIONS

1. Maximum leakage current each line-to-ground @ 115VAC 60Hz: 0.20mA
@ 250VAC 50Hz: 0.40mA
2. Hipot rating (one minute)
line-to-ground: 2250VDC
line-to-line: 1450VDC
3. Operating frequency: 50/60Hz
4. Rated voltage: 115/250VAC

COMPONENTS

PART NO.	L (mH)	Cx (uF)	Cy (pF)
03GKEG3E/03GKEW3E	3.1	0.1	2200
06GKEG3E/06GKEW3E	1.2	0.1	
10GKEG3E/10GKEW3E	0.36	0.1	

• VDE approved to 9A/250V

MINIMUM INSERTION LOSS IN dB

COMMON MODE (L-G) IN 50 OHM SYSTEM						
PART Number	FREQUENCY-MHz					
	.15	.50	1.0	5.0	10	30
03GKEG3E/03GKEW3E	20	25	30	40	40	50
06GKEG3E/06GKEW3E	12	20	25	35	45	45
10GKEG3E/10GKEW3E	7	10	15	30	35	50
DIFFERENTIAL MODE (L-L) IN 50 OHM SYSTEM						
03GKEG3E/03GKEW3E	5	25	50	55	53	45
06GKEG3E/06GKEW3E	7	20	35	50	50	40
10GKEG3E/10GKEW3E	7	9	25	50	45	35

ELECTRICAL SCHEMATIC

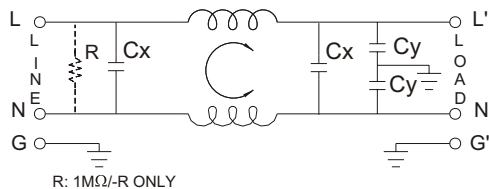

MECHANICAL CONSTRUCTION

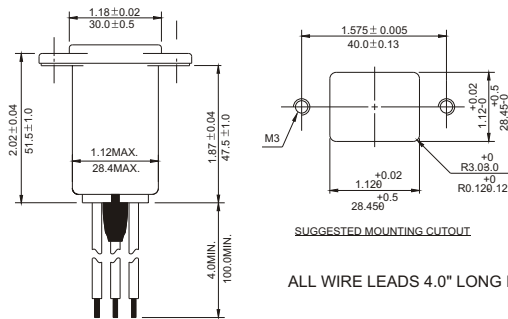
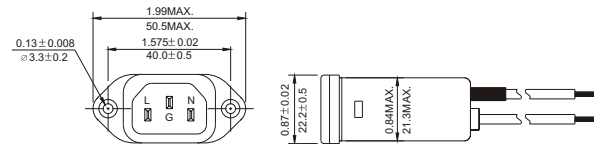
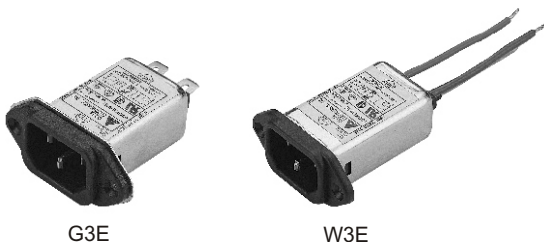

W3E

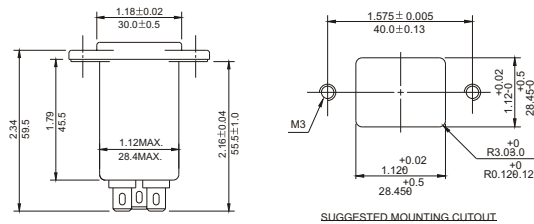
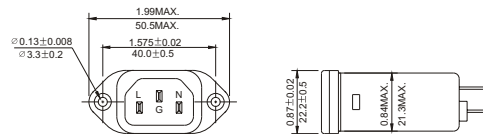

G3E

UNIT: INCH/mm



GKN SERIES

SNAP-IN MOUNTING HIGH PERFORMANCE IEC CONNECTOR FILTERS



INTRODUCTIONS

1. Specially designed with additional X capacitor providing most effective EMI suppression for low frequency noise (ranged 150KHz-500KHz).
2. Bleeder resistor can be added with suffix "-R" on part numbers.
3. With optional Y capacitor from 100pF to 3300pF.
4. All part numbers are UL recognized, CSA certified and VDE approved.

COMPONENTS

PART Number	L (mH)	Cx (uF)	Cy (pF)
03GKNG3E/03GKNW3E	3.1	0.1	2200
06GKNG3E/06GKNW3E	1.2	0.1	
10GKNG3E/10GKNW3E	0.36	0.1	

• VDE approved to 9A/250V

MINIMUM INSERTION LOSS IN dB

PART NO.	COMMON MODE (L-G) IN 50 OHM SYSTEM					
	FREQUENCY-MHZ					
	.15	.50	1.0	5.0	10	30
03GKNG3E/03GKNW3E	20	25	30	40	40	50
06GKNG3E/06GKNW3E	12	20	25	35	45	45
10GKNG3E/10GKNW3E	7	10	15	30	35	50

PART NO.	DIFFERENTIAL MODE (L-L) IN 50 OHM SYSTEM					
	FREQUENCY-MHZ					
	.15	.50	1.0	5.0	10	30
03GKNG3E/03GKNW3E	5	25	50	55	53	45
06GKNG3E/06GKNW3E	7	20	35	50	50	40
10GKNG3E/10GKNW3E	7	9	25	50	45	35

ELECTRICAL SCHEMATIC

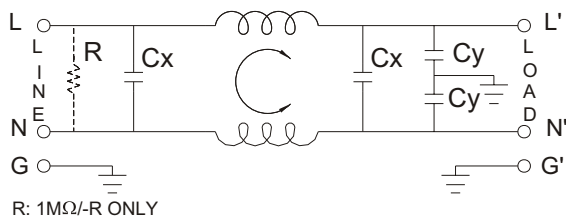

MECHANICAL CONSTRUCTION

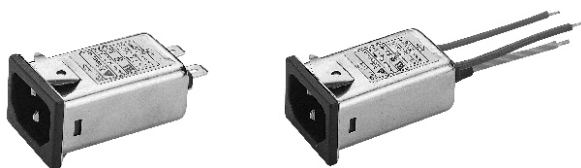

G3E

W3E

SPECIFICATIONS

1. Maximum leakage current each line-to-ground @ 115VAC 60Hz: 0.2mA @ 250VAC 50Hz: 0.4mA
2. Hipot rating (one minute) line-to-ground: 2250VDC line-to-line: 1450VDC
3. Operating frequency: 50/60Hz
4. Rated voltage: 115/250VAC

Suggested thickness of mounting panel is from 0.0315 (0.8) to 0.063 (1.6) inch(mm) of mounting cutout

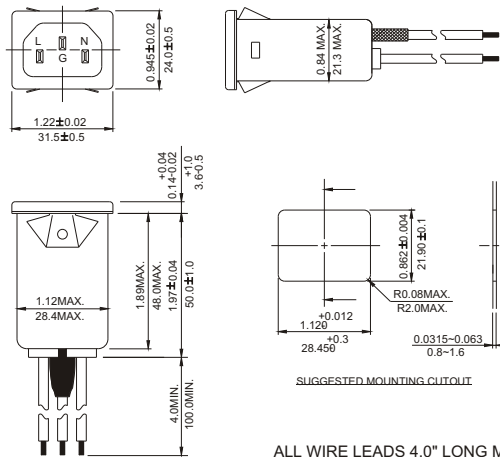

W3E

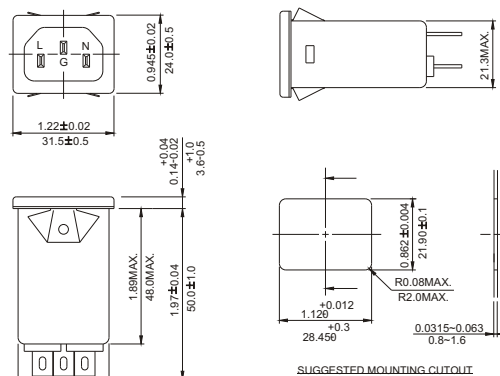

G3E

UNIT: INCH/mm



KE SERIES

HIGH PERFORMANCE IEC CONNECTOR FILTERS



INTRODUCTIONS

1. Specially designed with ground choke providing most effective EMI suppression for high frequency noise (ranged 5MHz-25MHz).
2. Bleeder resistor can be added with suffix "-R" on part numbers.
3. With optional Y capacitor 100pF to 330pF.
4. All part numbers are UL recognized, CSA certified and VDE approved.

COMPONENTS

PART NO.	L (mH)	Cx (uF)	Cy (pF)	Lg (uH)
03KEEG3EA/03KEEW3EA	3.1	0.1	2200	100
*08KEEG3EA/08KEEW3EA	0.8			
**10KEEG3EA/10KEEW3EA	0.4			
***03KEEG3SA/03KEEW3SA	3.1			
***06KEEG3SA/06KEEW3SA	0.8			
***10KEEG3SA/10KEEW3SA	0.4			

*VDE approved to 6A 250V.
 **UL, CSA & VDE approved to 9A 115/250VAC.
 *** SEMKO approved, UL & cUL under approve.

MINIMUM INSERTION LOSS IN dB

PART NO.	COMMON MODE (L-G) IN 50 OHM SYSTEM					
	FREQUENCY-MHz					
	.15	.50	1.0	5.0	10	30
03KEEG3EA/03KEEW3EA	15	20	25	40	40	45
08KEEG3EA/08KEEW3EA	10	15	20	35	40	50
10KEEG3EA/10KEEW3EA	7	12	18	30	30	50
03KEEG3SA/03KEEW3SA	15	20	25	40	40	40
06KEEG3SA/06KEEW3SA	7	15	20	35	40	40
10KEEG3SA/10KEEW3SA	4	12	18	30	30	45

PART NO.	DIFFERENTIAL MODE (L-L) IN 50 OHM SYSTEM					
	FREQUENCY-MHz					
	.15	.50	1.0	5.0	10	30
03KEEG3EA/03KEEW3EA	5	12	15	40	50	45
08KEEG3EA/08KEEW3EA	5	10	15	45	40	50
10KEEG3EA/10KEEW3EA	4	12	18	30	30	50
03KEEG3SA/03KEEW3SA	10	20	35	40	45	40
06KEEG3SA/06KEEW3SA	10	25	40	35	40	40
10KEEG3SA/10KEEW3SA	10	25	35	30	30	45

ELECTRICAL SCHEMATIC

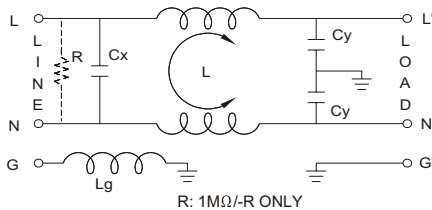

MECHANICAL CONSTRUCTION

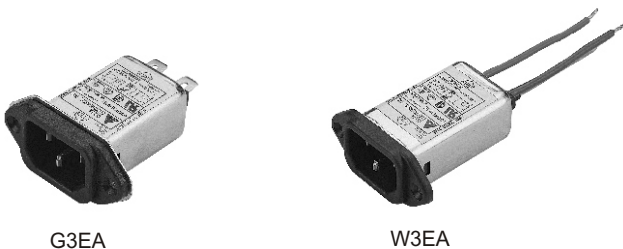

G3EA

W3EA

SPECIFICATIONS

1. Maximum leakage current each line-to-ground @ 115VAC 60Hz: 0.20mA @ 250VAC 50Hz: 0.40mA
2. Hipot rating (one minute) line-to-ground: 2250VDC line-to-line: 1450VDC
3. Operating frequency: 50/60Hz
4. Rated voltage: 115/250VAC

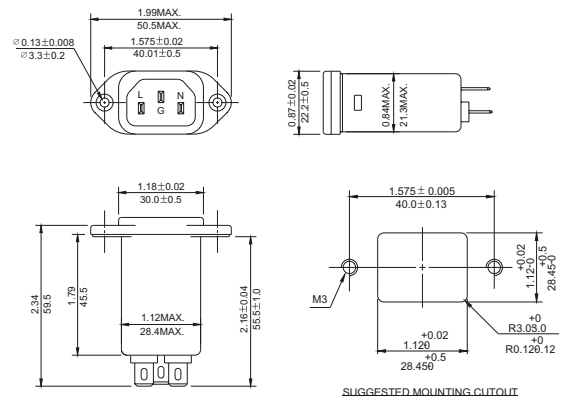
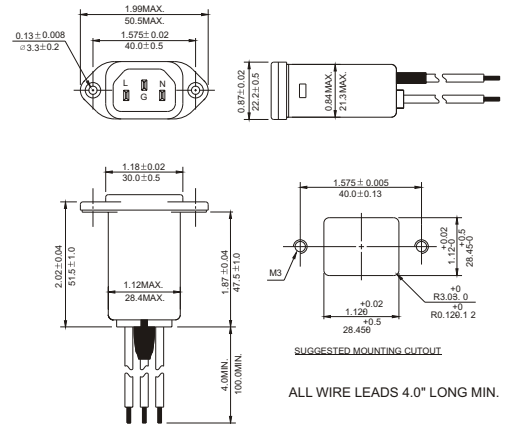
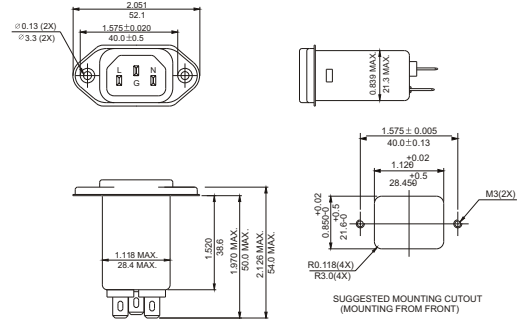

IEC INLET FILTERS

UNIT: INCH/mm



KEN SERIES

HIGH PERFORMANCE SNAP-IN FILTERS



IEC INLET FILTERS

INTRODUCTIONS

1. Specially designed with ground choke providing most effective EMI suppression for high frequency noise (ranged 5MHz-25MHz).
2. Bleeder resistor can be added with suffix "-R" on part numbers.
3. With optional Y capacitor from 100pF to 3300pF.
4. All part numbers are UL recognized, CSA certified and VDE approved.
5. Optional side snap-in mounting clip type with suffix (H) on part numbers. for 03/06/10KENG3SA series.

COMPONENTS

PART NO.	L (mH)	Cx (uF)	Cy (pF)	Lg (uH)
03KENG3EA/03KENW3EA	3.1	0.1	2200	100
*08KENG3EA/08KENW3EA	0.8			
**10KENG3EA/10KENW3EA	0.4			
***03KENG3SA/03KENG3SA	3.1			
***06KENG3SA/06KENG3SA	0.8			
***10KENG3SA/10KENG3SA	0.4			

* VDE approved to 6A 250V.
 ** UL, CSA & VDE approved to 9A 115/250 VAC.
 *** SEMKO approved, UL & cUL under approve.

MINIMUM INSERTION LOSS IN dB

COMMON MODE (L-G) IN 50 OHM SYSTEM						
PART NO.	FREQUENCY-MHz					
	.15	.50	1.0	5.0	10	30
03KENG3EA/03KENW3EA	15	20	25	40	40	45
08KENG3EA/08KENW3EA	10	15	20	35	40	50
10KENG3EA/10KENW3EA	7	12	18	30	30	50
03KENG3SA/03KENW3SA	15	20	25	40	40	40
06KENG3SA/06KENW3SA	7	15	20	35	40	40
10KENG3SA/10KENW3SA	4	12	18	30	30	45
DIFFERENTIAL MODE (L-L) IN 50 OHM SYSTEM						
03KENG3EA/03KENW3EA	5	12	15	40	50	45
08KENG3EA/08KENW3EA	5	10	15	45	40	50
10KENG3EA/10KENW3EA	4	12	18	30	30	50
03KENG3SA/03KENW3SA	10	20	35	40	45	40
06KENG3SA/06KENW3SA	10	25	40	35	40	40
10KENG3SA/10KENW3SA	10	25	35	30	30	45

ELECTRICAL SCHEMATIC

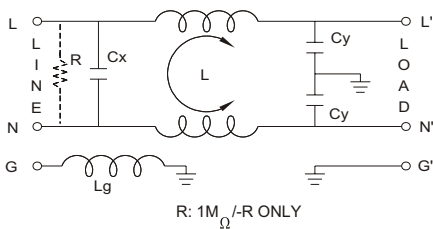

MECHANICAL CONSTRUCTION

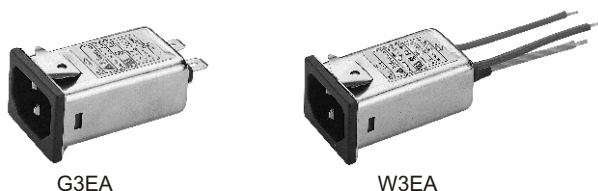

SPECIFICATIONS

1. Maximum leakage current each line-to-ground @ 115VAC 60Hz: 0.20mA @ 250VAC 50Hz: 0.40mA
2. Hipot rating (one minute) line-to-ground: 2250VDC line-to-line: 1450VDC
3. Operating frequency: 50/60Hz
4. Rated voltage: 115/250VAC

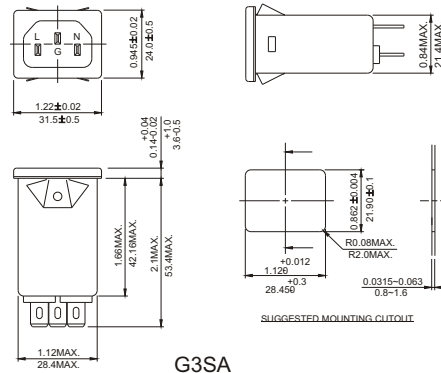

Suggested thickness of mounting panel is from 0.0315 (0.8) to 0.063 (1.6) inch(mm) of mounting cutout

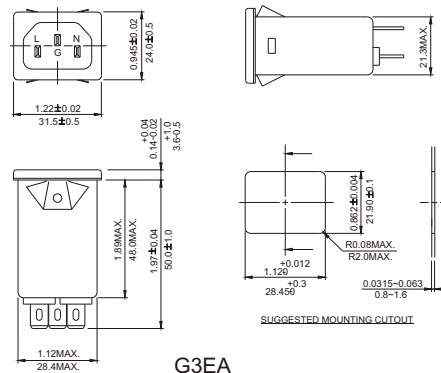
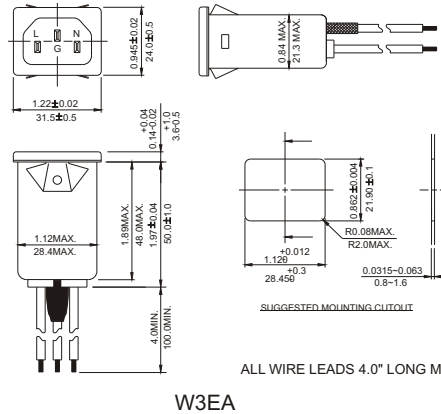

UNIT: INCH/mm

INTRODUCTIONS

1. Direct PC board mounting for easy installation and space saving.
2. ME2: UL,
ME3D/P:
ME3:
ME3G:
ME3B:
ME3DA/GA:
15ME2/ME3:
02ME4E2:
ME4: UL, CSA, TUV

UL, CSA, VDE,

SPECIFICATIONS

1. Maximum leakage current each
line-to-ground @ 115VAC 60Hz: 0.20mA
0.45mA (02ME4E1)
@ 250VAC 50Hz: 0.40mA
0.80mA (02ME4E1)
2. Hipot rating (one minute)
line-to-ground: 2250VDC
line-to-line: 1450VDC
3. Operating frequency: 50/60Hz
4. Rated voltage: 115/250VAC

COMPONENTS

PART NO.	C1 (uF)	L1 (mH)	PART NO.	C1 (uF)	L1 (mH)
01ME2	0.1	3.7	03ME3G-R(S)	0.1	2.5
01ME3(S)	0.033	5	03ME4/P	0.47	15
02ME3G(S)	0.1	7	06ME2	0.1	0.4
02ME3GA(S)			06ME3(S)	0.033	0.6
02ME3G-R(S)	0.47	25	06ME3D(S)	0.047	0.53
02ME4E1			06ME3DA(S)		
*02ME4E2	0.22	25	06ME3G(S)	0.1	0.8
*02MP1		20	06ME3GA(S)		
*02MP2	25	06ME3G-R(S)	0.1	0.1	
03ME2	0.1	1.3	10ME2	0.1	0.1
03ME2A	0.1	2.5	10ME3(S)	0.033	0.18
03ME3(S)	0.033	2.3	10ME3G(S)	0.1	0.2
03ME3G(S)	0.1	2.5	10ME3		
*03ME3GA(S)			1.2	**15ME2	0.1
*03ME3B	**15ME3(S)				
03ME3DA(S)	0.047	1.2			
03ME3D(S)					

- * UL, CSA approved to 2.5A 115/250VAC
- 03ME3D(S): 03ME3D, 03ME3D(S)
- VDE, SEV, SEMKO approved to 10A/250VAC

MINIMUM INSERTION LOSS IN dB

COMMON MODE (L-G) IN 50 OHM SYSTEM															
TYPE	CURRENT RATING	FREQUENCY-MHz						TYPE	CURRENT RATING	FREQUENCY-MHz					
		.15	.50	1.0	5.0	10	30			.15	50	1.0	5.0	10	30
01ME2	1A	27	37	42	44	45	35	03ME3G	3A	20	25	30	38	40	40
01ME3(S)	1A	25	35	40	40	40	40	03ME3GA	3A	20	23	30	40	40	40
02ME3G(S)	2A	28	35	28	38	40	40	06ME2	6A	12	18	20	35	40	50
02ME3GA(S)	2A	20	25	35	40	40	40	06ME3	6A	12	20	25	40	45	45
02ME4E1	2A	35	45	45	35	35	35	06ME3D	6A	10	20	20	30	35	40
02ME4E2	2.5/2A	30	40	40	35	35	40	06ME3DA	6A	8	10	15	30	30	40
02ME4/P	2A	35	45	45	35	35	35	06ME3G	6A	10	15	20	35	40	40
02MP1	2.5/2A	45	60	60	45	40	25	06ME3GA	6A	10	15	20	30	35	40
02MP2	2.5/2A	50	55	55	50	40	25	10ME3(S)	10A	4	10	15	30	38	45
03ME2	3A	15	28	32	45	45	50	10ME3G(S)	10A	4	10	13	28	35	40
03ME3	3A	22	30	35	45	45	48	15ME2	15A/10A	2	8	10	20	25	40
03ME3B	3A	12	20	28	40	40	40	15ME3(S)	15A/10A	2	8	10	20	25	40
03ME3D	3A	18	28	39	48	48	55								
03ME3DA	3A	15	25	30	40	40	45								
03ME4/P	3A	30	40	40	35	35	35								

ELECTRICAL SCHEMATIC

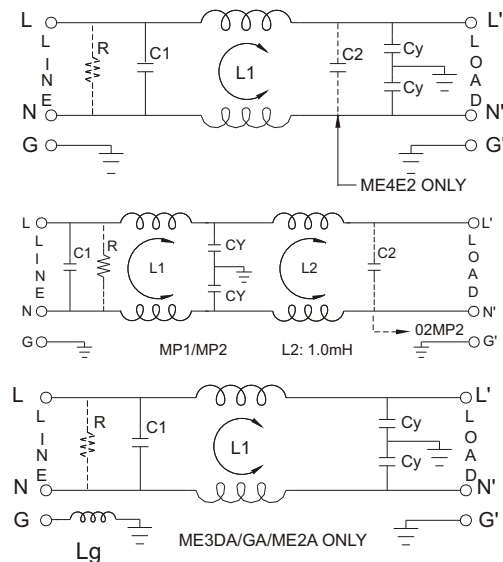

- R: 1MΩ(ME3) C2: 0.1μF(ME4E2/MP2)
- R: 560KΩ(ME4) R: 330KΩ(ME4E2)
- Cy: 2200pF
- Cy: 4700pF(ME4/E1)
- Lg: 18.3μH (2A/GA/DA)

INSERTION LOSS (TYPICAL)

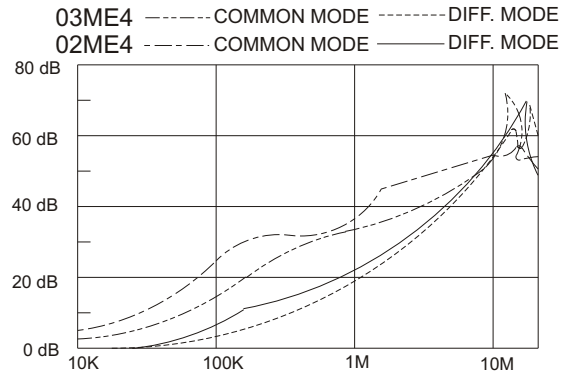
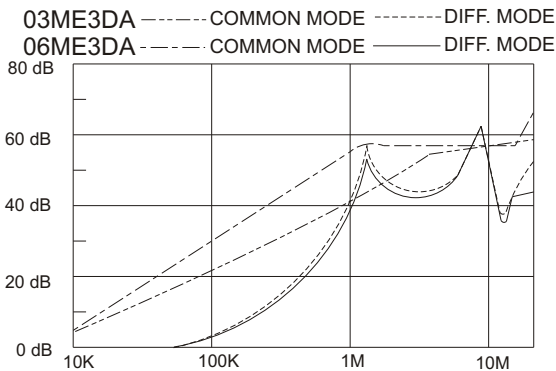
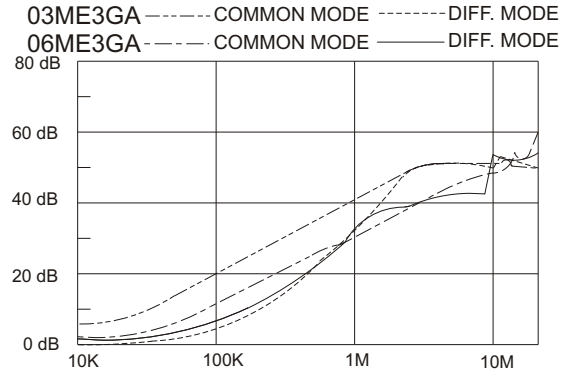
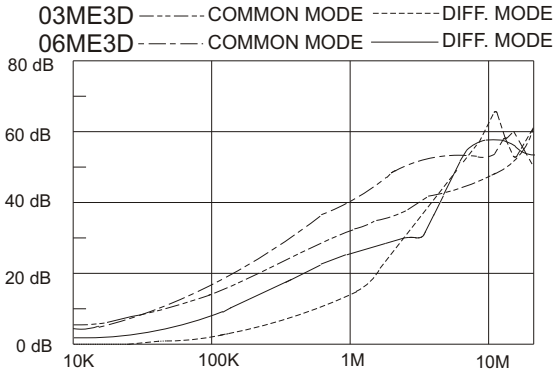
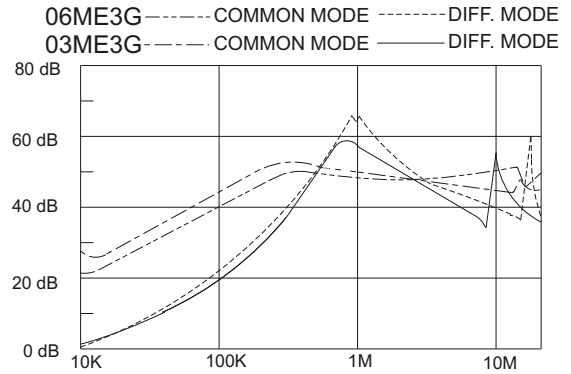
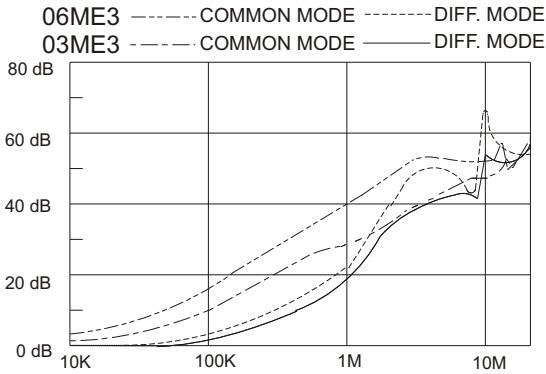

MECHANICAL CONSTRUCTION

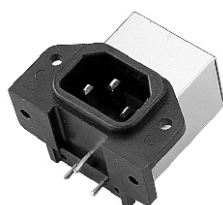

ME2/ME2A

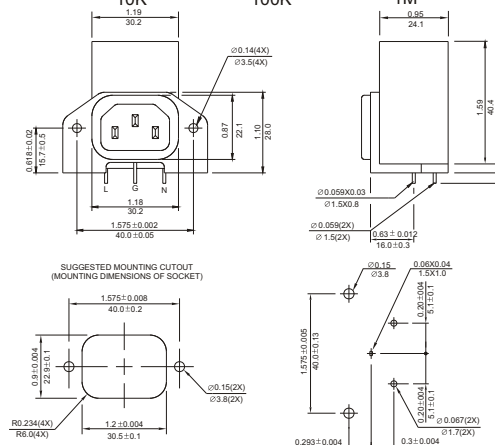

UNIT: INCH
mm

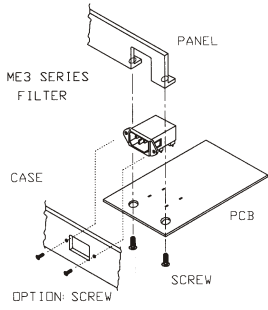

◆ **Proposal of installation for ME3 series please follow these steps to install:**

1. Insert filter to PCB and soldering.
2. Screw panel and filter on PCB.
3. Assemble case with PCB with panel and filter.

Note: - Socket of filter should be assembled with mounting hole of case tightly for easy insertion of power cord.
 - Screw from the outside of case to fix filter for more secured assembly (optional).



ME3

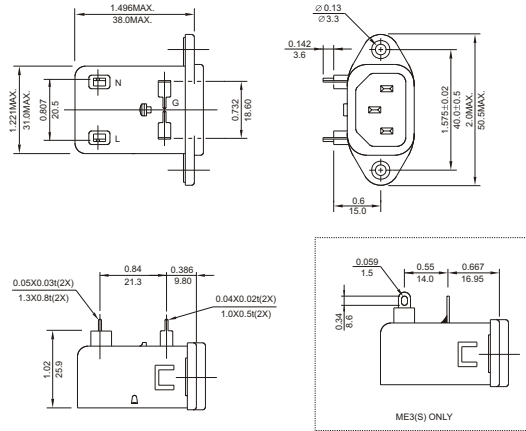

ME3DA

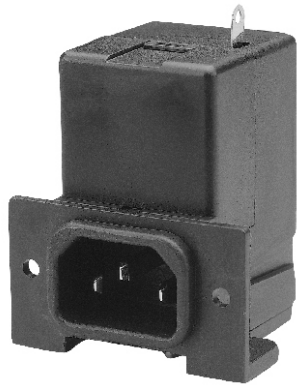
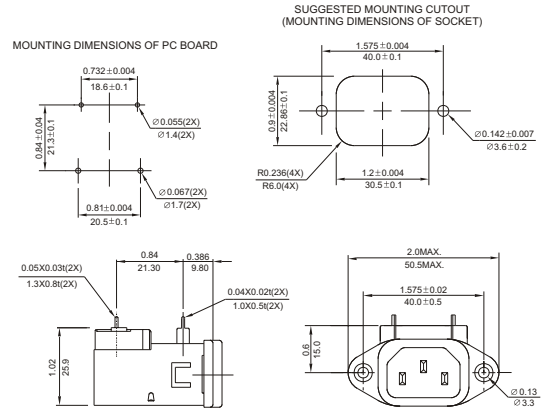

ME4E/MP

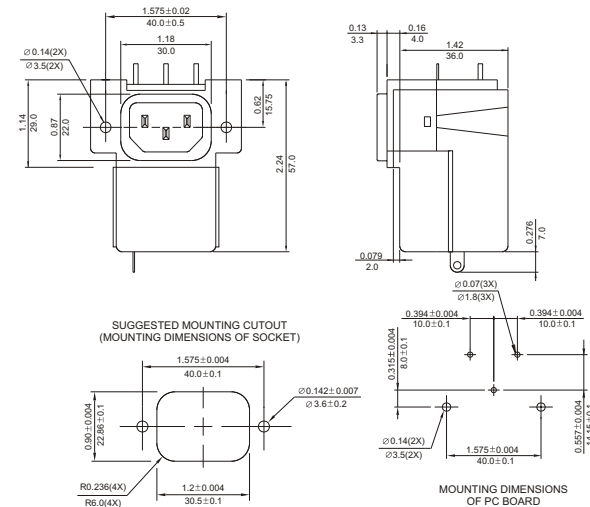

UNIT: INCH
mm

IEC INLET PC BOARD MOUNTING FILTERS

INTRODUCTIONS

1. Power module incorporates an IEC connector, a fuse holder with optional power on/off switch and voltage selector switch, plus an EMI filter all-in-one single, easy-to-install unit.
2. Fuse holder designed for one IEC 5x20mm fuse. Safety interlock prevents fuse removal with line plug inserted (Use only with 250V fuse).
3. All part numbers are UL recognized, CSA certified and VDE approved.

SPECIFICATIONS

1. Maximum leakage current each line-to-ground @ 115VAC 60Hz: 0.25mA @ 250VAC 50Hz: 0.45mA
2. Hipot rating (one minute) line-to-ground: 2250VDC line-to-line: 1450VDC
3. Operating frequency: 50/60Hz
4. Rated voltage: 115/250VAC

MINIMUM INSERTION LOSS IN dB

COMMON MODE (L-G) IN 50 OHM SYSTEM						
CURRENT RATING	FREQUENCY-MHz					
	.15	.50	1.0	5.0	10	30
3A	30	35	40	35	35	35
6A	16	25	30	42	45	40
DIFFERENTIAL MODE (L-L) IN 50 OHM SYSTEM						
3A	10	40	45	45	45	35
6A	6	25	30	42	45	40

TYPE & RATED CURRENT

DELTA PART NO.	AK1	AK2	AK2D	AK3	AK3D	AK4	AK5
RATED CURRENT	115VAC	6A	6A	6A	6A	6A	6A
	250VAC	6A	6A	4A	5A	4A	6A
IEC CONNECTOR	△	△	△	△	△	△	△
FUSE HOLDER	△	△	△	△	△	△	△
POWER SWITCH	-	SP ¹	DP ²	SP ¹	DP ²	-	-
VOLTAGE SELECTOR SW	-	-	-	REAR ³	REAR ³	REAR ³	FRONT ⁴
ELECTRICAL SCHEMATIC	FIG. A	FIG. A	FIG. B	FIG. A	FIG. B	FIG. A	FIG. C

1. Single-pole UL, CSA & VDE approved
Current rating: UL & CSA-6A both at 125VAC & 250VAC; VDE-6A at 250VAC.
Electrical lifetime: 50,000 cycles.
Maximum inrush current: 70A.
2. Double-pole UL CSA & VDE approved
Current rating: UL & CSA-6A at 125VAC, 4A at 250VAC; VDE-4A at 250VAC.
Electrical lifetime: 10,000 cycles.
Maximum inrush current: 50A.
3. Voltage selector SW -UL, CSA & VDE approved
Current rating: 10A at 125VAC; 5A at 250VAC.
4. Voltage selector SW -UL, CSA & VDE approved
Current rating: UL & CSA-6A both at 125VAC & 250VAC; VDE-6A at 250VAC.

ELECTRICAL SCHEMATIC

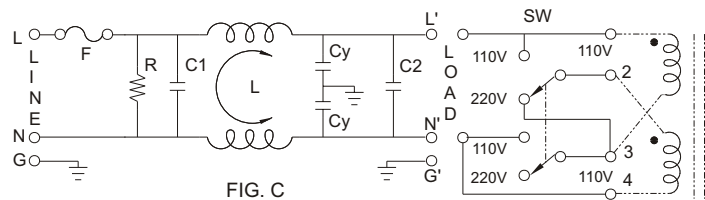
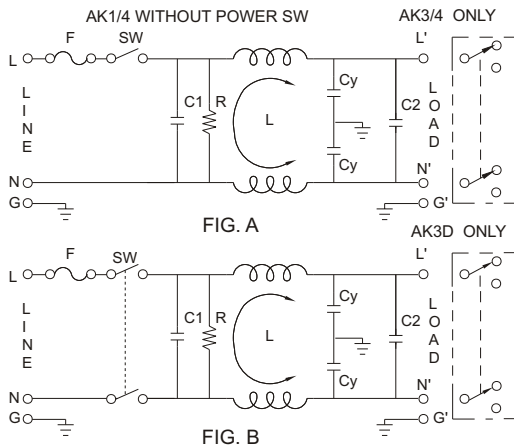

For transformers with two separate windings

COMPONENT VALUE:

- | | |
|------------|------------|
| 6A: | 3A: |
| R: 2.2MΩ | R: 1MΩ |
| C1: 0.1uF | C1: 0.1uF |
| C2: 0.1uF | C2: 0.1uF |
| Cy: 3300pF | Cy: 2200pF |
| L: 1.3mH | L: 14mH |

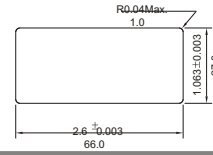

- Suggested thickness of mounting panel is from 0.04 to 0.07 inch
- Suggested mounting cutout

MECHANICAL CONSTRUCTION



AK5

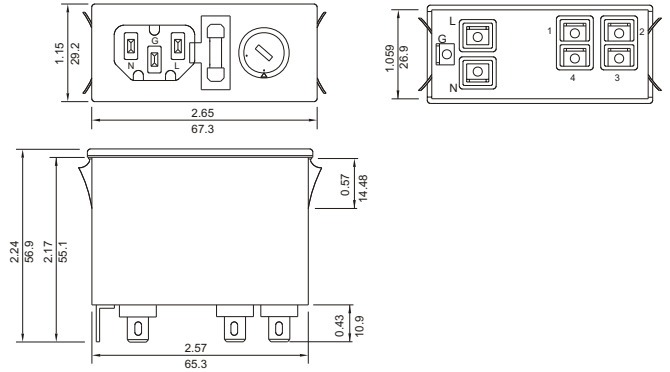

AK2,AK2D

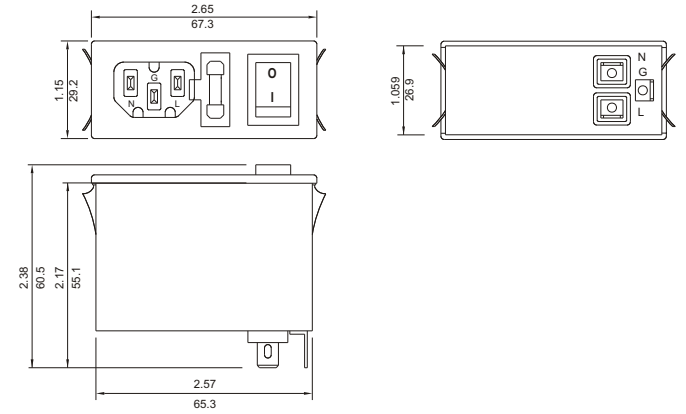

AK3,AK3D
AK4 (without power switch)

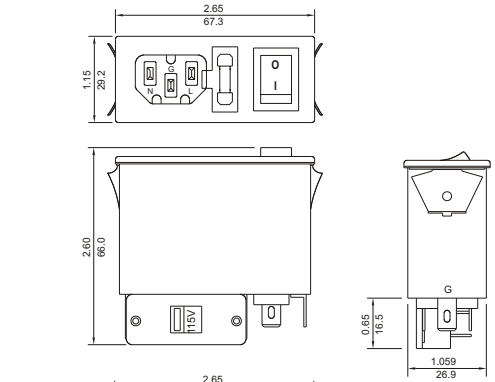

AK1

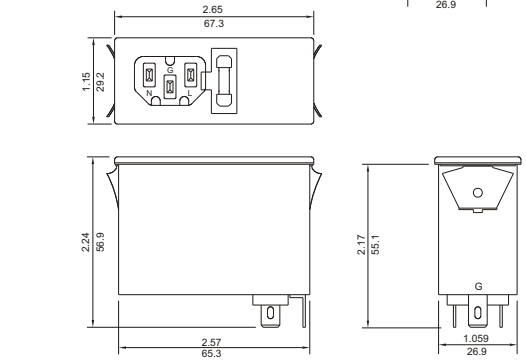

UNIT: INCH
mm

INTRODUCTIONS

1. AR series is designed as a high performance, two-stage filter for low impedance load with better noise attenuation than AK series in low frequency applications such as switching power supplies.
2. Fuse holder designed for one IEC 5x20mm fuse. Safety interlock prevents fuse removal with line plug inserted (Use only with 250V fuse).
3. All part numbers are UL recognized, CSA certified and VDE approved.

SPECIFICATIONS

1. Maximum leakage current each
line-to-ground @ 115VAC 60Hz: 0.25mA
@ 250VAC 50Hz: 0.45mA
2. Hipot rating (one minute)
line-to-ground: 2250VDC
line-to-line: 1450VDC
3. Operating frequency: 50/60Hz
4. Rated voltage: 115/250VAC

COMPONENTS

PART NO.	C1 (uF)	L1 (mH)	L2 (mH)	Cy (pF)	R (Ω)
03AR1/2/3	0.1	1.5	9	2200	1M
03AR2D/3D	0.033	9	1.5		
06AR1/2/3	0.1	0.7	2.5	3300	2.2M
06AR2D/3D	0.015	2.5	0.7		
06AR4	0.1	0.7	2.5		

MINIMUM INSERTION LOSS IN dB

COMMON MODE (L-G) IN 50 OHM SYSTEM						
CURRENT RATING	FREQUENCY-MHz					
	.15	.50	1.0	5.0	10	30
03AR	40	60	60	45	40	30
06AR	34	55	56	40	35	25
06AR2D,3D	34	60	60	45	40	30
DIFFERENTIAL MODE (L-L) IN 50 OHM SYSTEM						
03AR	6	45	55	50	45	40
06AR	5	25	60	50	45	35
06AR2D,3D	10	10	50	50	45	40

ELECTRICAL SCHEMATIC

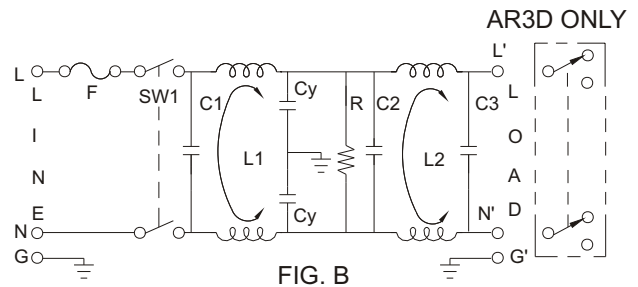
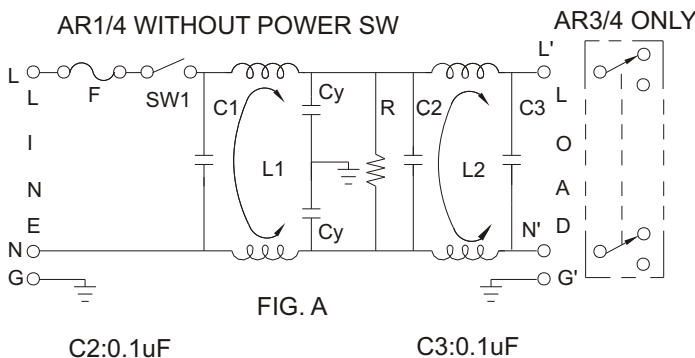

TYPE & RATED CURRENT

DELTA PART NO.		AR1	AR2	AR2D	AR3	AR3D	AR4
RATED CURRENT	115VAC	6A	6A	6A	6A	6A	6A
	250VAC	6A	6A	4A	5A	4A	6A
IEC CONNECTOR		△	△	△	△	△	△
FUSE HOLDER		△	△	△	△	△	△
POWER SWITCH		-	SP ¹	DP ²	SP ¹	DP ²	-
VOLTAGE SELECTOR SW		-	-	-	REAR ³	REAR ³	REAR ³
ELECTRICAL SCHEMATIC		FIG. A	FIG. A	FIG. B	FIG. A	FIG. B	FIG. A

1. Single-pole UL, CSA & VDE approved, VDE-6A at 250VAC.
Electrical lifetime: 50,000 cycles.
Maximum inrush current: 50A.
2. Double-pole UL, CSA & VDE approved, VDE-4A at 250VAC.
Electrical lifetime: 10,000 cycles.
Maximum inrush current: 50A.
3. Voltage selector SW -UL, CSA & VDE approved
Current rating: 10A at 125VAC; 5A at 250VAC.

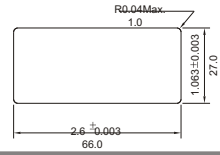

- Suggested thickness of mounting panel is from 0.04 to 0.07 inch
- suggest mounting cutout

MECHANICAL CONSTRUCTION

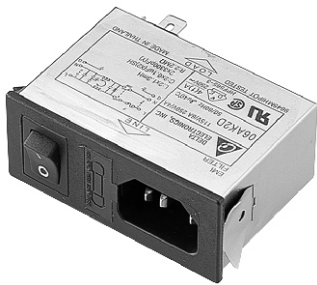

AR2, AR2D

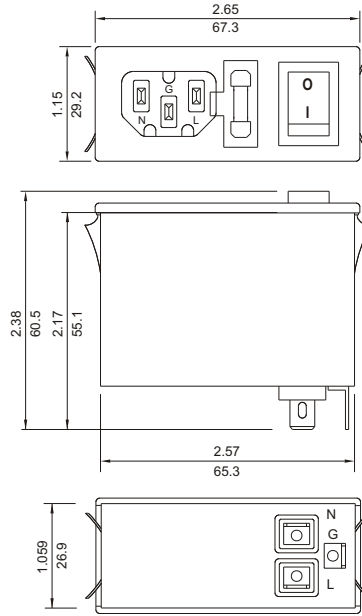

AR3, AR3D
AR4 (without power switch)

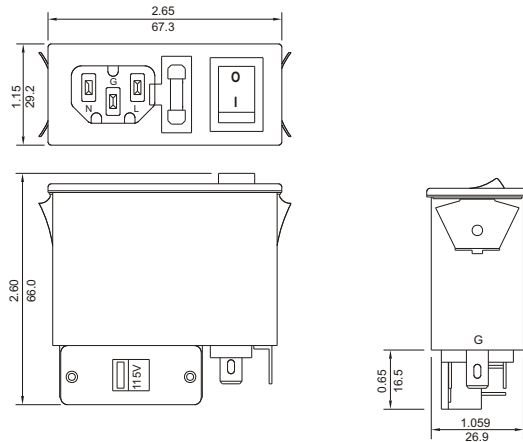

AR1

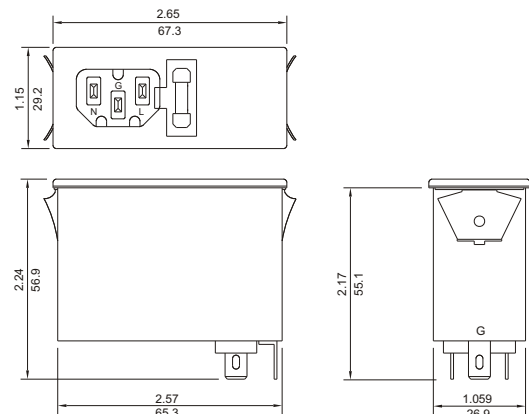

UNIT: INCH
mm

INTRODUCTIONS

1. Designed as a general purpose filter with a fuse holder providing effective EMI suppression for both common and differential mode noise.
2. All part numbers are UL recognized, CSA certified and VDE approved.

COMPONENTS

PART NO.	Cx (uF)	L (mH)	Cy (pF)	Lg (mH)
02BEEG3H	0.1	2.4	3300	-
04BEEG3H		2.8		
04BEEG3S	0.015	0.7	2200	0.4
04BEEG3SA	0.1			
06BEEG3H		1.3	3300	-

MINIMUM INSERTION LOSS IN dB

COMMON MODE (L-G) IN 50 OHM SYSTEM						
CURRENT RATING	FREQUENCY-MHz					
	.15	.50	1.0	5.0	10	30
2A	25	35	40	55	55	55
4A	26	30	40	50	55	45
4A(S)	26	30	40	50	55	45
6A	20	30	35	50	55	45
DIFFERENTIAL MODE (L-L) IN 50 OHM SYSTEM						
2A	6	15	25	40	45	45
4A	6	15	25	40	45	45
4A(S)	1	5	12	30	40	40
6A	6	15	20	40	45	45

ELECTRICAL SCHEMATIC

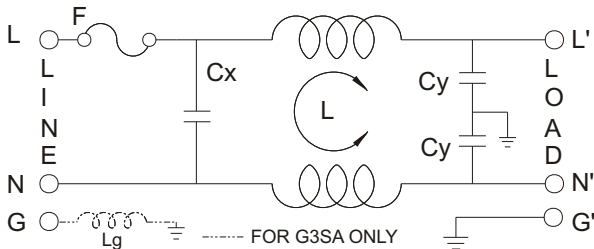

MECHANICAL CONSTRUCTION



EG3H, EG3S

SPECIFICATIONS

1. Maximum leakage current each
line-to-ground @ 115VAC 60Hz: 0.25mA
@ 250VAC 50Hz: 0.45mA
2. Hipot rating (one minute)
line-to-ground: 2250VDC
line-to-line: 1450VDC
3. Operating frequency: 50/60Hz
4. Rated voltage: 115/250VAC

SERIES DIMENSIONS

DELTA PART NO.	STYLE	DIMENSIONS IN INCHES/mm				
		A	B	C	D	E
02BEEG3H	EG3H					
04BEEG3H	EG3H	2.56 65.0	2.42 61.5	2.00 50.8	1.417 35.99	1.75 44.5
06BEEG3H	EG3H					
04BEEG3S/A	EG3S	2.25 57.2	2.1 53.3	1.65 41.91		

INSERTION LOSS (TYPICAL)

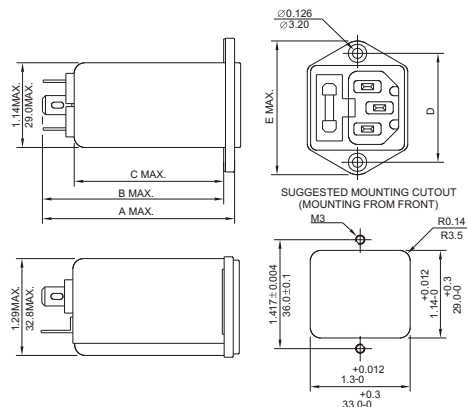
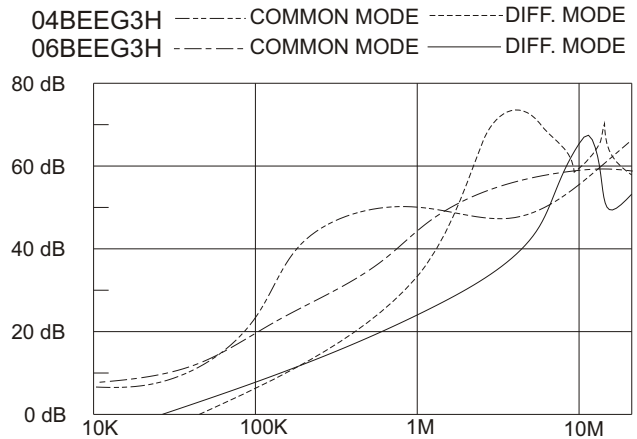

UNIT: INCH
mm

INTRODUCTIONS

1. Designed as a general purpose filter with a fuse holder providing effective EMI suppression for both common and differential mode noise.
2. All part numbers are UL recognized, CSA certified and VDE approved.
3. Bleeder resistor is added with suffix "-R".
4. With optional Y CAP. from 100pF ~ 4700pF.

COMPONENTS

PART NO.	Cx (uF)	L (mH)	Cy (pF)	R(Ω)
02BEEG3F/-R	0.1	4.0	3300	1M
04BEEG3F/-R		1.8		
06BEEG3F/-R		0.8		

MINIMUM INSERTION LOSS IN dB

COMMON MODE (L-G) IN 50 OHM SYSTEM						
CURRENT RATING	FREQUENCY-MHz					
	.15	.50	1.0	5.0	10	30
2A	29	38	40	42	43	41
4A	19	30	32	42	42	39
6A	13	22	26	38	42	38
DIFFERENTIAL MODE (L-L) IN 50 OHM SYSTEM						
2A	5	19	28	48	51	50
4A	5	14	21	48	48	42
6A	5	12	15	40	46	38

ELECTRICAL SCHEMATIC

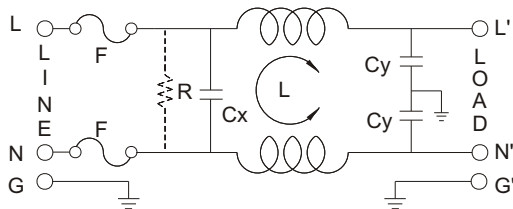

MECHANICAL CONSTRUCTION



BEEG3F

SPECIFICATIONS

1. Maximum leakage current each line-to-ground @ 115VAC 60Hz: 0.25mA @ 250VAC 50Hz: 0.45mA
2. Hipot rating (one minute) line-to-ground: 2250VDC line-to-line: 1450VDC
3. Operating frequency: 50/60Hz
4. Rated voltage: 115/250VAC

SERIES DIMENSIONS

DELTA PART NO.	STYLE	DIMENSIONS IN INCHES/mm				
		A	B	C	D	E
02BEEG3F	EG3F	2.263	2.106	1.66	1.42	1.74
04BEEG3F	EG3F	57.5	53.5	42.0	36.0	44.0
06BEEG3F	EG3F					

INSERTION LOSS (TYPICAL)

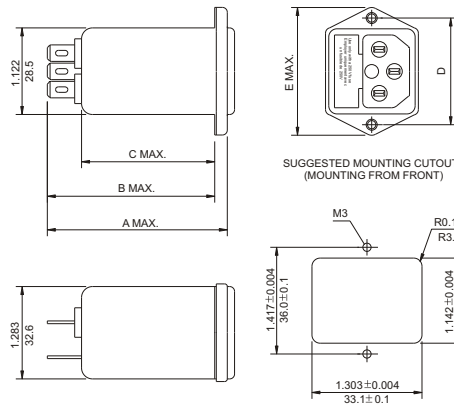
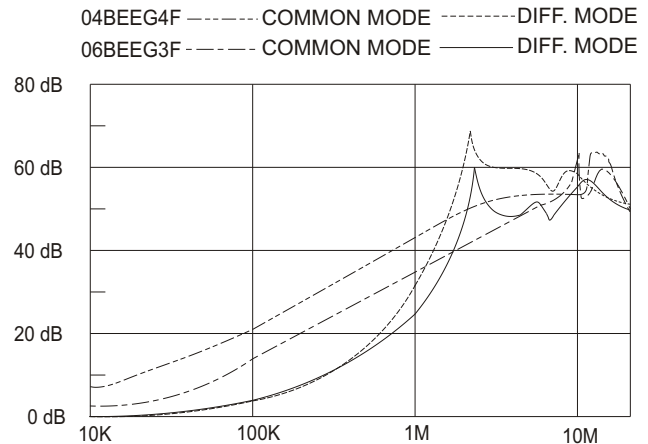

UNIT: INCH
mm

INTRODUCTIONS

1. Designed as a general purpose filter with a switch effective EMI suppression for both common and differential mode noise.
2. With optional resistor and 3300pF/1000pF
3. Bleeder resistor is added with suffix "-R".
4. Switch electrical lifetime : 10,000 cycles.
Maximum inrush current : 50A.

COMPONENTS

PART NO.	Cx (uF)	L (mH)	Cy (pF)	R (Ω)	Lg (mH)
03BEEG3G/NG3G/-R	0.1	2.4	2200	1M	0.12
03BEEG3GA/NG3GA/-R					
06BEEG3G/NG3G/-R		0.8			
06BEEG3GA/NG3GA/-R					
10BEEG3G/NG3G/-R		0.3			
10BEEG3GA/NG3GA/-R					

A: with ground choke

MINIMUM INSERTION LOSS IN dB

COMMON MODE (L-G) IN 50 OHM SYSTEM						
CURRENT RATING	FREQUENCY-MHz					
	.15	.50	1.0	5.0	10	30
3A (G) (A)	20	30	35	35	35	35
6A (G) (A)	10	20	25	35	40	35
10A (G) (A)	5	10	20	30	35	35
DIFFERENTIAL MODE (L-L) IN 50 OHM SYSTEM						
3A (G) (A)	4	10	20	35	35	40
6A (G) (A)	4	10	10	35	35	40
10A (G) (A)	5	10	20	30	35	35

MECHANICAL CONSTRUCTION



BENG3G



BEEG3G

SPECIFICATIONS

1. Maximum leakage current each
line-to-ground @ 115VAC 60Hz: 0.25mA
@ 250VAC 50Hz: 0.45mA
2. Hipot rating (one minute)
line-to-ground: 2250VDC
line-to-line: 1450VDC
3. Operating frequency: 50/60Hz
4. Rated voltage: 115/250VAC

ELECTRICAL SCHEMATIC

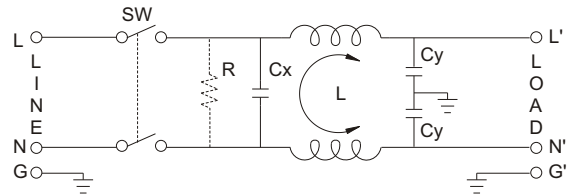

R: OPTION

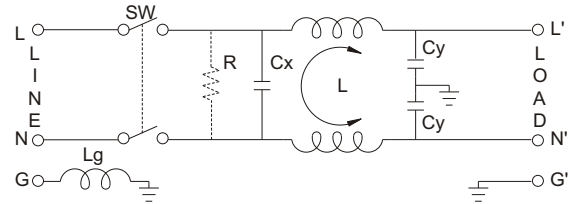

3GA ONLY

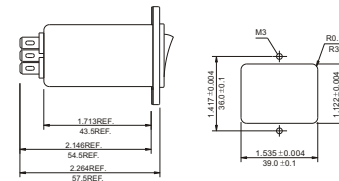
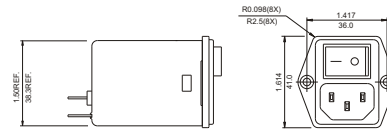

BEEG3G

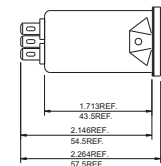
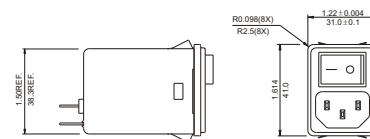

BENG3G

SUGGESTED MOUNTING CUTOUT (MOUNTING FROM FRONT)

SUGGESTED MOUNTING CUTOUT (MOUNTING FROM FRONT)

Suggested thickness of mounting panel is from 0.04(1.0) to 0.63(1.6) inch(mm) of mounting cutout

UNIT: INCH
mm



EB SERIES

POWER ENTRY MODULE EMI FILTERS

INTRODUCTIONS

1. Power module incorporates an IEC connector, single or double-fuse (IEC 5 x 20mm or 3AG 6.3 x32mm) holder, optional voltage selector switch and double-pole power switch, plus an EMI filter all-in-one easy-to-install unit.
2. Adapts to 110-120V or 220-240V input voltage by simply reversing the fuse cartridge.
3. All part numbers are UL recognized, CSA certified and VDE approved.

SPECIFICATIONS

1. Maximum leakage current each line-to-ground @ 115VAC 60Hz: 0.25mA @ 250VAC 50Hz: 0.45mA
2. Hipot rating (one minute) line-to-ground: 2250VDC line-to-line: 1450VDC
3. Operating frequency: 50/60Hz
4. Rated voltage: 115/250VAC

COMPONENTS



PART NO.	L (mH)	Cx (uF)	Cy (pF)	R (Ω)
03EB3	8	0.22	3300	1M
03EB3A				
03EB3S				
03EB3SA				
06EB3	2.5	0.22	3300	1M
06EB3A				
06EB3S				
06EB3SA				
10EB3	1.6	0.22	3300	1M
10EB3A				
10EB3S				
10EB3SA				

Lg: 400 uH (EB3A 5B3SA only)



PART NO.	L (mH)	Cx (uF)	Cy (pF)	R (Ω)
05EB3B/S	0.93	0.01	2200	1M

TYPE & FEATURE

DELTA PART NO.	03EB3 05EB3B 06EB3 10EB3	03EB3A 06EB3A 10EB3A	03EB3S 05EB3BS 06EB3S 10EB3S	03EB3SA 06EB3SA 10EB3SA
• FUSE	DOUBLE	DOUBLE	SINGLE	SINGLE
IEC CONNECTOR	△	△	△	△
•DOUBLE POLE POWER SWITCH	△	△	△	△
VOLTAGE SELECTOR SW	△	△	△	△
ELECTRICAL SCHEMATIC	FIG. A	FIG. B	FIG. A	FIG. B

- UL, CSA & VDE approved current rating: UL-10A both at 125VAC & 250VAC; CSA & VDE-6A at 250VAC.
- UL, CSA & VDE approved current rating: UL & CSA-10A both at 125VAC & 250VAC; VDE-10A at 250VAC. Electrical lifetime: 10,000 cycles. Maximum inrush current: 70A.

ELECTRICAL SCHEMATIC

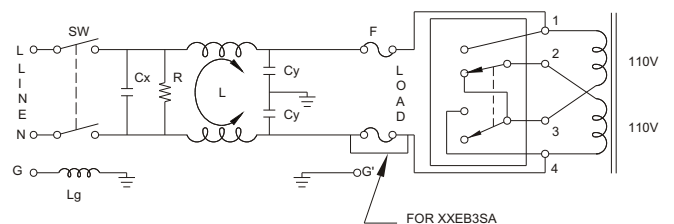
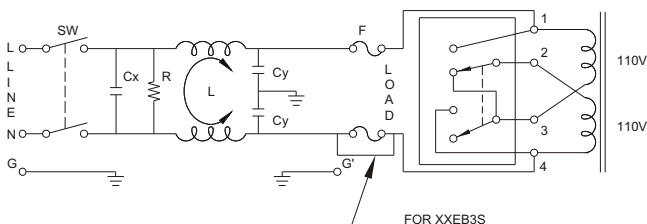

EB3A, EB3SA
FIG. B

INSERTION LOSS (TYPICAL)

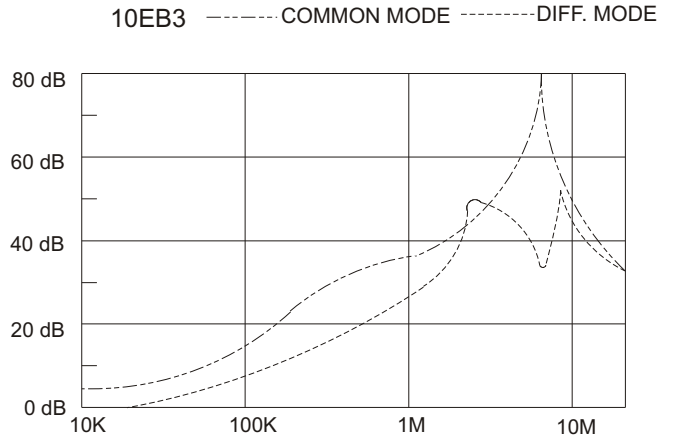
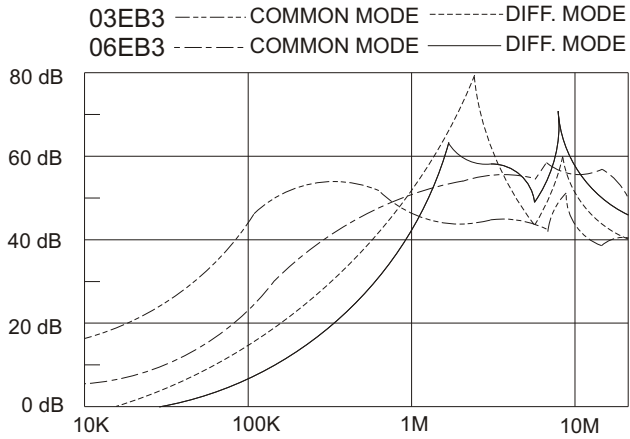

MINIMUM INSERTION LOSS IN dB

COMMON MODE (L-G) IN 50 OHM SYSTEM								
CURRENT RATING	FREQUENCY-MHz							
	0.05	0.10	0.15	0.50	1.0	5.0	10	30
3A (S)	20	25	30	38	38	38	38	25
6A (S)	10	15	20	30	35	40	40	30
•10A (S)	10	15	20	20	30	40	40	30
3A (A,SA)	20	25	30	40	40	40	45	30
6A (A,SA)	10	15	20	25	30	40	45	30
•10A (A,SA)	10	15	20	25	30	45	50	30
DIFFERENTIAL MODE (L-L) IN 50 OHM SYSTEM								
3A (S)	2	9	12	30	40	30	40	30
6A (S)	2	5	8	20	30	30	45	40
•10A (S)	2	5	8	15	30	40	45	35
3A (A,SA)	2	8	12	30	40	35	40	30
6A (A,SA)	2	5	10	15	30	45	50	40
•10A (A,SA)	2	5	8	20	30	50	50	40

• CSA approved 6A at 125/250 VAC; VDE-6A/250VAC

MECHANICAL CONSTRUCTION

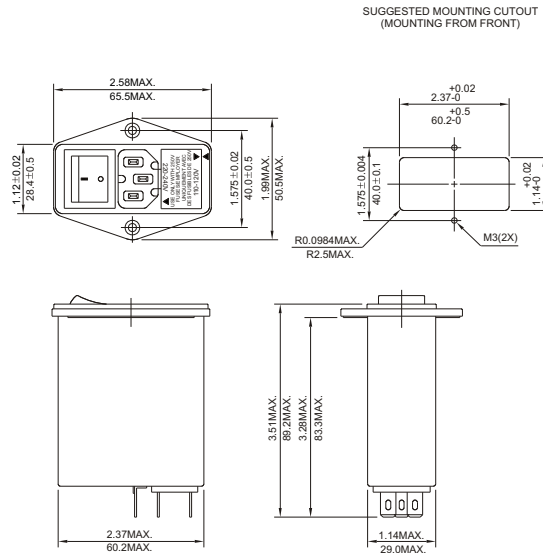

INTRODUCTIONS

1. Power module incorporates an IEC connector, single or double-fuse (IEC 5x20mm or 3AG 6.3x32mm) holder, optional voltage selector switch and double-pole power switch, plus an EMI filter all-in-one easy-to-install unit.
2. Adapts to 100-120V or 200-240V input voltage by simply reversing the fuse cartridge.
3. All part numbers are UL recognized, CSA certified and VDE approved.

SPECIFICATIONS

1. Maximum leakage current each
 line-to-ground @ 115VAC 60Hz: 0.25mA
 0.4mA (4700pF)
 @ 250VAC 50Hz: 0.45mA
 0.8mA(4700pF)
2. Hipot rating (one minute)
 line-to-ground: 2250VDC
 line-to-line: 1450VDC
3. Operating frequency: 50/60Hz
4. Rated voltage: 115/250VAC

COMPONENTS

PART NO.	L (mH)	C1 (uF)	C2 (uF)	Cy (pF)	UL	SP	VDE
03EK3/A	8	0.22	0.1	3300	✓	✓	✓
03EK3B/S	2.3	0.22	0.1	4700	✓		✓
03EK3L/S	13.77	0.47	0.22	4700			✓
03EK3S/A	8	0.22	0.1	3300	✓	✓	✓
06EK3/A	2.5						
06EK3S/A							
10EK3/A	1.6						
10EK3S/A							

R: 1MΩ
 Lg: 400uH (EK3A, EK3SA only)

TYPE & FEATURE

DELTA PART NO.	03EK3 03EK3B 03EK3L 06EK3 10EK3	03EK3A 06EK3A 10EK3A	03EK3S 03EK3BS 03EK3LS 06EK3S 10EK3S	03EK3SA 06EK3SA 10EK3SA
• FUSE	DOUBLE	DOUBLE	SINGLE	SINGLE
IEC CONNECTOR	△	△	△	△
•• DOUBLE-POLE POWER SWITCH	△	△	△	△
VOLTAGE SELECTOR SW	△	△	△	△
ELECTRICAL SCHEMATIC	FIG. A	FIG. B	FIG. A	FIG. B

- UL, CSA & VDE approved current rating:
 UL-10A both at 125VAC & 250VAC; CSA & VDE-6A at 250VAC.
- UL, CSA & VDE approved current rating:
 UL & CSA-10A both at 125VAC & 250VAC; VDE-10A at 250VAC.
 Electrical lifetime: 10,000 cycles.
 Maximum inrush current: 70A.

ELECTRICAL SCHEMATIC

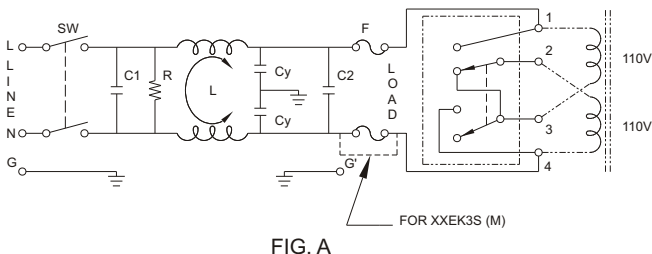
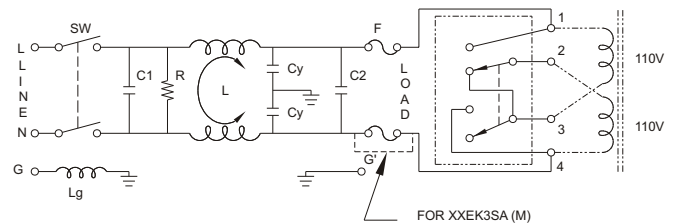
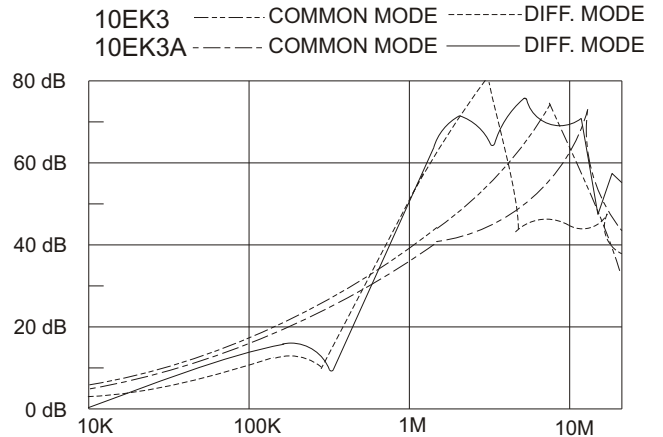
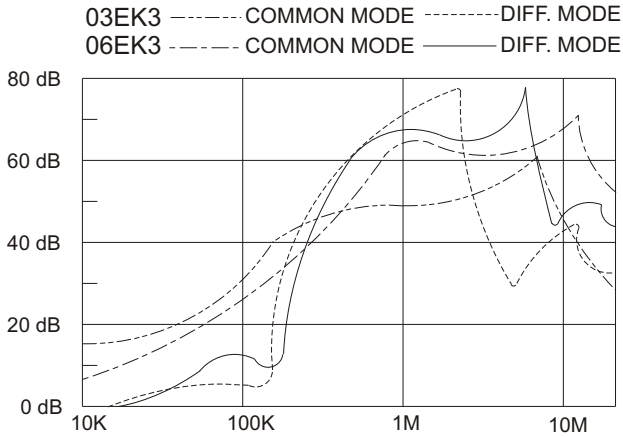

FIG. A



EK3A, EK3SA
 FIG. B

INSERTION LOSS (TYPICAL)



MINIMUM INSERTION LOSS IN dB

COMMON MODE (L-G) IN 50 OHM SYSTEM						
CURRENT RATING	FREQUENCY-MHz					
	.15	.50	1.0	5.0	10	30
3A	32	38	38	38	38	25
6A	20	30	35	40	40	30
•10A	15	25	30	40	40	30
3A(A,SA)	30	40	40	40	45	25
6A(A,SA)	20	30	35	40	40	30
•10A(A,SA)	20	25	30	45	45	30
DIFFERENTIAL MODE (L-L) IN 50 OHM SYSTEM						
3A	20	50	55	40	40	30
6A	5	40	50	40	40	40
•10A	3	35	45	40	40	30
3A(A,SA)	20	50	50	50	45	30
6A(A,SA)	5	40	50	40	40	40
•10A(A,SA)	3	35	45	45	40	30

• CSA approved 6A at 125/250VAC; VDE-6A/250VAC

MECHANICAL CONSTRUCTION

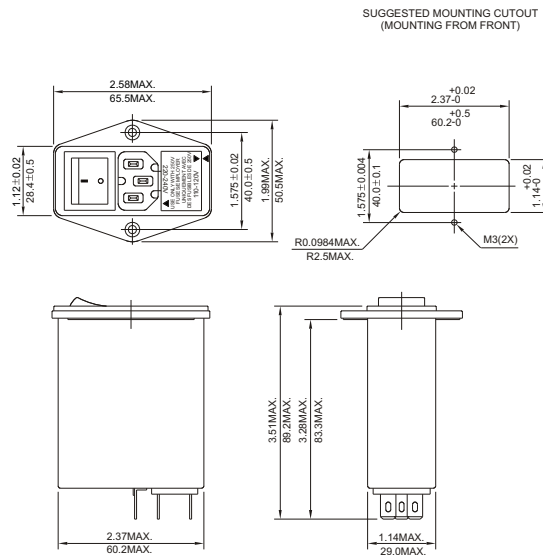

UNIT: INCH
mm

INTRODUCTIONS

1. Power module incorporates an IEC connector, single or double-fuse (IEC 5x20mm) holder, and double-pole power switch, plus an EMI filter all-in-one easy-to-install unit.
2. All part numbers are UL, CSA and VDE approved.
3. With optional Y CAP. from 1000/3300pF.

COMPONENTS

PART NO.	C1 (uF)	L (mH)	Cy (pF)	R (Ω)
03NB3	0.1	2.5	2200	1M
03NB4				
03NB3S				
04NB3				
04NB4				
04NB3S				
06NB3				
06NB4				
06NB3S				
10NB3				
10NB4				
10NB3S				
03SB3				
03SB4				
03SB3S				
04SB3				
04SB4				
04SB3S				
06SB3				
06SB4				
06SB3S				
10SB3				
10SB4				
10SB3S				

SPECIFICATIONS

1. Maximum leakage current each line-to-ground@115VAC 60Hz: 0.2mA
@250VAC 50Hz: 0.4mA
2. Hipot rating (one minute)
line-to-ground: 2250VDC
line-to-line: 1450VDC
3. Operating frequency: 50/60Hz
4. Rated voltage: 115/250VAC

ELECTRICAL SCHEMATIC

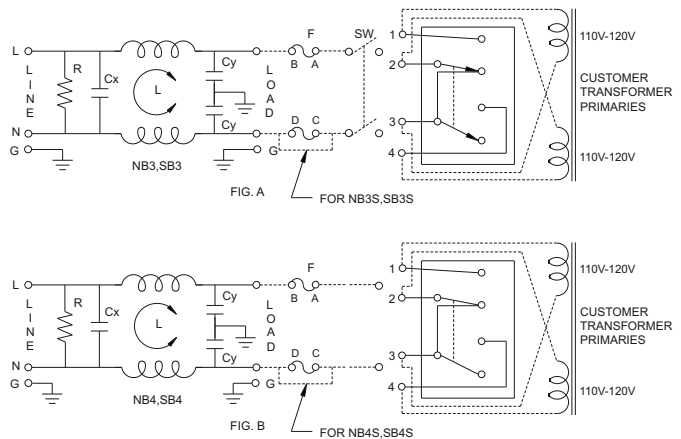

TYPE & RATED CURRENT

DELTA PART NO.		03NB3/SB3	04NB3/SB3	06NB3/SB3	10NB3/SB3	03NB4/SB4	04NB4/SB4	06NB4/SB4	10NB4/SB4
RATED CURRENT	115VAC	3A	4A	6A	10A	3A	4A	6A	10A
	250VAC	3A	4A	6A	10A	3A	4A	6A	10A
IEC CONNECTOR		▲	▲	▲	▲	▲	▲	▲	▲
FUSE		DOUBLE	DOUBLE	DOUBLE	DOUBLE	DOUBLE	DOUBLE	DOUBLE	DOUBLE
*DOUBLE POLE POWER SWITCH		▲	▲	▲	▲	-	-	-	-
ELECTRICAL SCHEMATIC		FIG. A	FIG. A	FIG. A	FIG. A	FIG. B	FIG. B	FIG. B	FIG. B

3S,4S Fuse single
 NB4,SB4 W/O switch
 Electrical lifetime: 10,000 cycles.
 Maximum inrush current: 50A

INSERTION LOSS (TYPICAL)

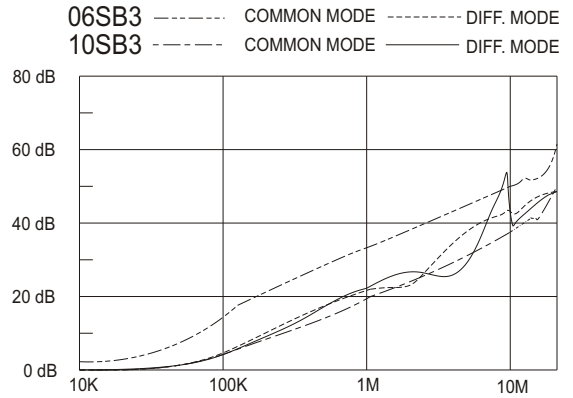
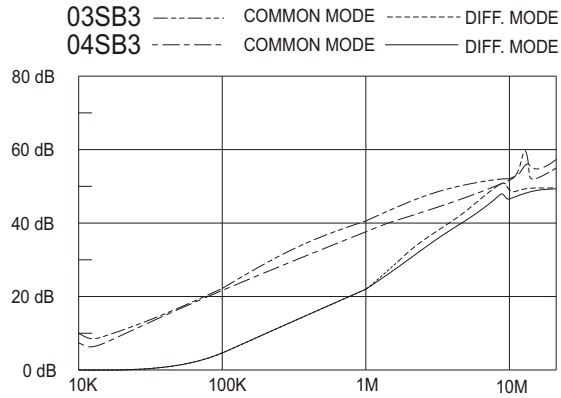

MINIMUM INSERTION LOSS IN dB

COMMON MODE (L-G) IN 50 OHM SYSTEM						
CURRENT RATING	FREQUENCY-MHz					
	.15	.50	1.0	5.0	10	30
03NB3/SB3	20	25	30	38	40	40
03NB4/SB4	20	25	30	38	40	40
03NB3S/SB3S	20	25	30	38	40	40
04NB3/SB3	20	25	25	40	40	40
04NB4/SB4	20	25	25	40	40	40
04NB3S/SB3S	20	25	25	40	40	40
06NB3/SB3	12	18	24	35	40	40
06NB4/SB4	12	18	24	35	40	40
06NB3S/SB3S	12	18	24	35	40	40
10NB3/SB3	3	8	10	20	30	45
10NB4/SB4	3	8	10	20	30	45
10NB3S/SB3S	3	8	10	20	30	45

COMMON MODE (L-L) IN 50 OHM SYSTEM						
CURRENT RATING	FREQUENCY-MHz					
	.15	.50	1.0	5.0	10	30
03NB3/SB3	4	12	18	38	40	40
03NB4/SB4	4	12	18	38	40	40
03NB3S/SB3S	4	12	18	38	40	40
04NB3/SB3	3	10	15	30	35	35
04NB4/SB4	3	10	15	30	35	35
04NB3S/SB3S	3	10	15	30	35	35
06NB3/SB3	4	10	15	35	40	40
06NB4/SB4	4	10	15	35	40	40
06NB3S/SB3S	4	10	15	35	40	40
10NB3/SB3	5	12	15	30	30	40
10NB4/SB4	5	12	15	30	30	40
10NB3S/SB3S	5	12	15	30	30	40

MECHANICAL CONSTRUCTION



NB3

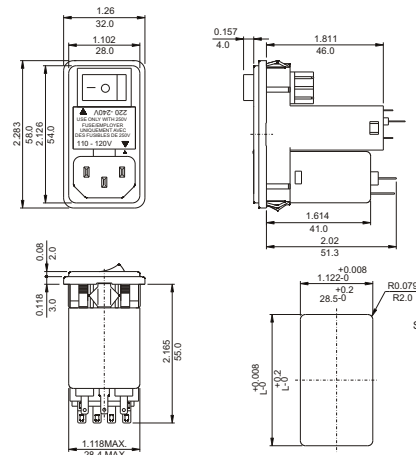

NB3,3S

SUGGESTED MOUNTING CUTOUT
(MOUNTING FROM FRONT)
L According to Panel Thickness
0.8-2.0mm L=55.9
2.1-3.2mm L=56.2



NB4

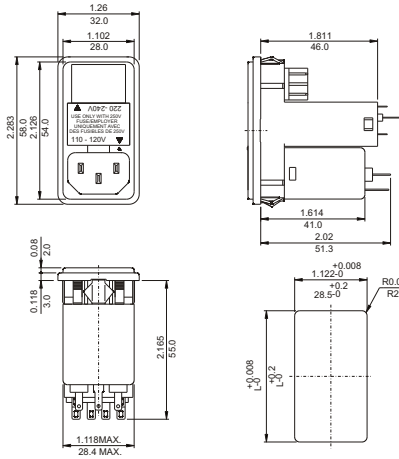

NB4

SUGGESTED MOUNTING CUTOUT
(MOUNTING FROM FRONT)
L According to Panel Thickness
0.8-2.0mm L=55.5
2.1-3.2mm L=56.2



SB3,3S

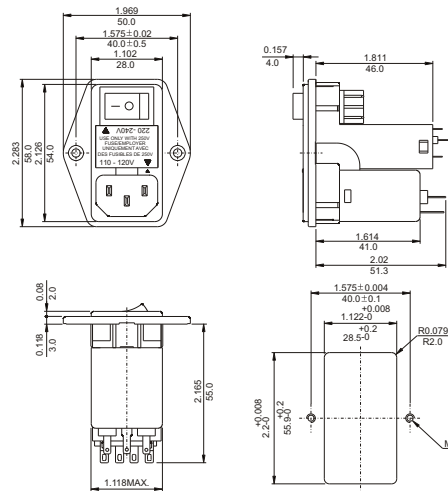

SB3,3S

SUGGESTED MOUNTING CUTOUT
(MOUNTING FROM FRONT)



SB4

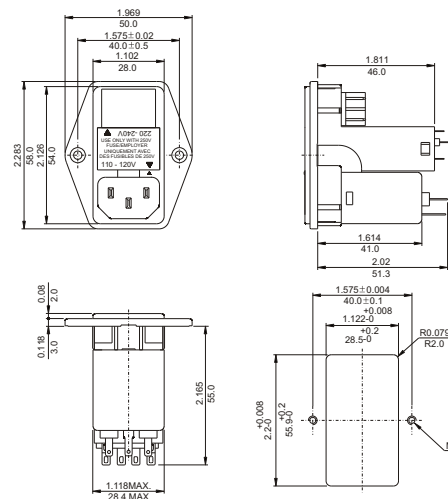

SB4

SUGGESTED MOUNTING CUTOUT
(MOUNTING FROM FRONT)



IB SERIES POWER ENTRY MODULE EMI FILTERS



INTRODUCTIONS

1. Power module incorporates an IEC connector, single or double-fuse (IEC 5 x 20mm) holder, and double-pole power switch, plus an EMI filter all-in-one easy-to-install unit.
2. All part numbers are UL recognized, CSA certified and VDE approved.

COMPONENTS

PART NO.	Cx (uF)	L (mH)	Cy (pF)	R (Ω)
01IB2D	0.22	7.5	2200	1M
01IB2S				
03IB2D		2.0		
03IB2S				
06IB2D	0.45			
06IB2S				

MINIMUM INSERTION LOSS IN dB

COMMON MODE (L-G) IN 50 OHM SYSTEM						
CURRENT RATING	FREQUENCY-MHz					
	0.15	0.50	1.0	5.0	10	30
1A	28	40	40	35	35	25
3A	15	30	35	35	40	25
6A	8	15	20	32	40	25
DIFFERENTIAL MODE (L-G) IN 50 OHM SYSTEM						
1A	10	20	28	35	38	35
3A	8	15	20	30	35	35
6A	8	15	15	30	35	35

TYPE & RATED CURRENT

DELTA PART NO.	01IB2D	03IB2D	06IB2D	01IB2S	03IB2S	06IB2S
RATED CURRENT	115VAC 250VAC	1A 3A	3A 6A	6A 1A	1A 3A	3A 6A
IEC CONNECTOR						
FUSE		DOUBLE		SINGLE		
•DOUBLE-POLE POWER SWITCH		DOUBLE		DOUBLE		
ELECTRICAL SCHEMATIC		FIG. A		FIG. B		

- UL, CSA, VDE approved current rating: UL/CSA-10A both at 125VAC and 250VAC; VDE-4A/250VAC.
- Electrical lifetime: 10,000 cycles.
- Maximum inrush current: 50A.

MECHANICAL CONSTRUCTION



IB2D

SPECIFICATIONS

1. Maximum leakage current each line-to-ground @ 115VAC 60Hz: 0.2mA @ 250VAC 50Hz: 0.4mA
2. Hipot rating (one minute) line-to-ground: 2250VDC line-to-line: 1450VDC
3. Operating frequency: 50/60Hz
4. Rated voltage: 115/250VAC

ELECTRICAL SCHEMATIC

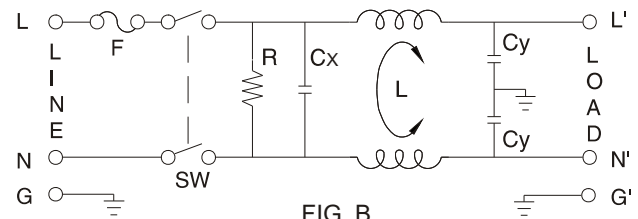
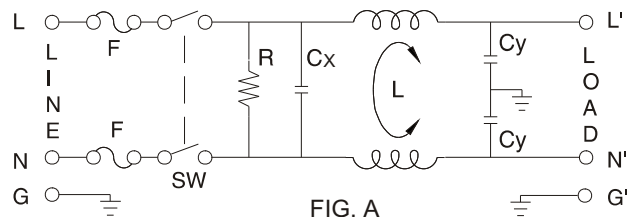

SUGGESTED MOUNTING CUTOUT

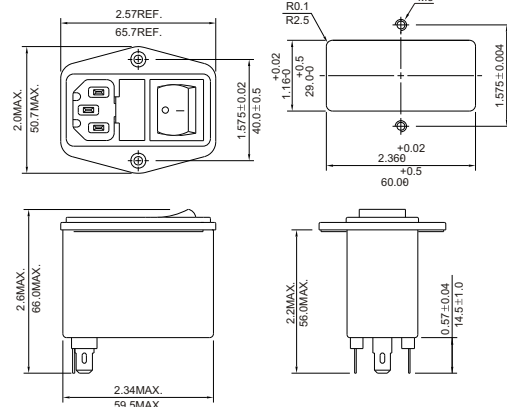

UNIT: INCH/mm

POWER ENTRY MODULE FILTERS

INTRODUCTIONS

1. Designed as a general purpose filter providing effective EMI suppression.
2. All part numbers are UL recognized, CSA certified and VDE approved.

COMPONENTS

PART NO.	Cx (uF)	L (mH)	Cy (pF)	R (Ω)
02DBAG5	0.1	1.1	3300	-
02DBAW5				
03DBAG5				
03DBAW5				
05DBAG5				
05DBAW5	2.9			
• 05DBDG3	0.22	2.1	-	-
• 05DBDW3				
06DBDW3S	0.47	3.7	330K	
10DBAG5	0.1	1.5	3300	-
10DBAW5				
10DBAS5				
10DBDW3S	0.47	1.45	330K	
10DBDG3S				
* 16DBDG3	1.0	3.6	10000	200K
* 16DBC5	2.2			
20DBAG5	0.33	0.7	3300	-
20DBAS5				
12DBBG5B	0.1	0.7	4700	1.0M
12DBBW5B				
16DBC5B				
16DBCW5B				
20DBC5B				
20DBCS5B				
30DBCS5B	0.47	0.67	10000	

- UL & CSA approved only.
- * No safety approval yet

MINIMUM INSERTION LOSS IN dB

COMMON MODE (L-G) IN 50 OHM SYSTEM						
CURRENT RATING	FREQUENCY-MHz					
	.15	.50	1.0	5.0	10	30
2,3,5A	15	30	38	45	45	40
6A	20	25	35	40	45	35
10A	20	30	35	50	50	45
* 10A	15	22	30	40	40	45
16A(DG3)	20	30	35	45	50	35
* 16A(CG5)	20	30	35	50	50	40
20A	13	20	25	40	45	45
12A (BG5B) (BW5B)	10	20	22	35	40	40
16A (CG5B) (CW5B)	10	18	20	35	50	30
20A (CG5B) (CS5B)	10	20	22	30	35	35
30A (CS5B)	10	28	30	45	50	35
DIFFERENTIAL MODE (L-L) IN 50 OHM SYSTEM						
2,3,5A	6	15	20	40	45	45
6A	10	18	20	30	35	40
10A	6	15	20	44	45	45
* 10A	12	18	20	35	35	40
16A (DG3)	10	30	50	50	50	50
* 16A (CG5)	20	30	40	45	40	30
20A	15	24	28	45	45	45
12A (BG5B) (BW5B)	5	12	15	35	45	35
16A (CG5B) (CW5B)	5	10	15	45	45	40
20A (CG5B) (CS5B)	4	10	15	45	45	40
30A (CS5B)	12	20	25	45	50	45

* 10DBDG3S, DW3S

SPECIFICATIONS

1. Maximum leakage current each
 - line-to-ground @ 115VAC 60Hz: 0.25mA
 - 1.0mA (10000pF)
 - @ 250VAC 50Hz: 0.45mA
 - 2.0mA (10000pF)
2. Hipot rating (one minute)
 - line-to-ground: 2250VDC
 - line-to-line: 1450VDC
3. Operating frequency: 50/60Hz
4. Rated voltage: 115/250VAC

SERIES DIMENSIONS

CURRENT RATING	STYLE	DIMENSIONS IN INCHES/mm				
		A	B	C	D	E
2A	AG5	2.15	-	0.65	-	2.54
		54.6				
	0.96					
2A	AW5	24.4	-	16.5	-	64.5
		2.54				
	64.5					
3A	AG5	1.33	1.77	0.77	2.13	2.50
		33.8				
	33.8					
3A	AW5	33.8	45.0	19.5	54.1	63.5
		2.54				
	64.5					
5A	AG5	1.33	45.0	19.5	54.1	63.5
		33.8				
	33.8					
6A	DW3S	2.55	2.08	1.29	1.575	0.61
		64.77	52.83	32.77	40.01	15.49
10A	AG5	2.54	1.77	1.18	2.13	2.50
		64.5				
		1.33				
	AW5	33.8	45.0	30.0	54.1	64.8
		3.10				
	AS5	78.7				
	DW3S	DW3S	2.55	2.08	1.29	1.575
64.80			52.80	32.80	40.00	15.50
DG3S		3.14	2.10	1.28	1.575	0.61
16A	DG3	79.80	53.30	32.50	40.00	15.50
		4.35	1.34	1.65	2.24	0.63
		110.50	34.0	42.0	57.0	16.0
	CG5	3.75	2.06	1.54	2.94	3.34
		95.25	52.30	39.10	74.70	84.80
	AG5	3.25	2.02	1.16	2.38	2.75
		82.5	51.3	29.5	60.5	69.9
AS5	3.37	2.02	1.15	2.38	2.77	

CURRENT RATING	STYLE	DIMENSIONS IN INCHES/mm					
		A	B	C	D	E	F
12A	BG5B	2.13	2.54	1.34	1.77	-	-
	BW5B	54.00	64.5	34.0	45.0		
16A	CG5B	2.40	2.81	1.79	2.02	1.18	-
	CW5B	61.00	71.5	45.5	51.3		
20A	CG5B	2.95	3.34	2.04	2.52	-	-
	CS5B	75.00	84.8	51.8	64.0		
30A	CS5B	4.06	4.49	2.22	3.74	1.83	-
		103.0	114.0	56.5	95.0	46.4	

ELECTRICAL SCHEMATIC

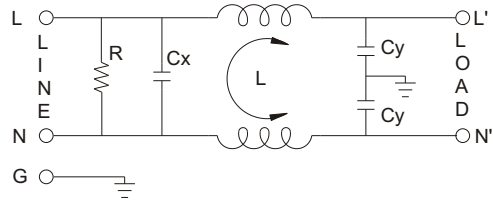
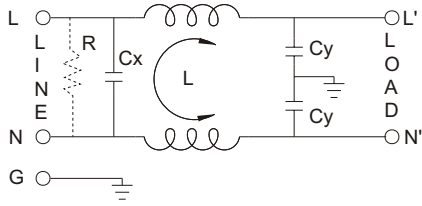

XXDBXX5B

INSERTION LOSS (TYPICAL)

02DBAG5----- COMMON MODE ----- DIFF. MODE
03DBAG5----- COMMON MODE ----- DIFF. MODE

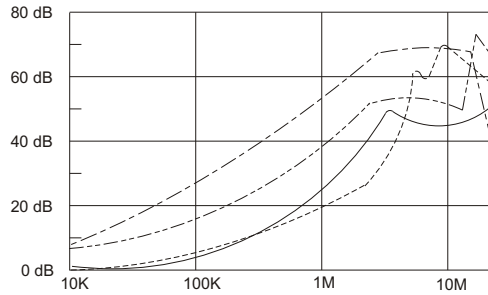

05DBAG5----- COMMON MODE ----- DIFF. MODE
10DBAG5----- COMMON MODE ----- DIFF. MODE

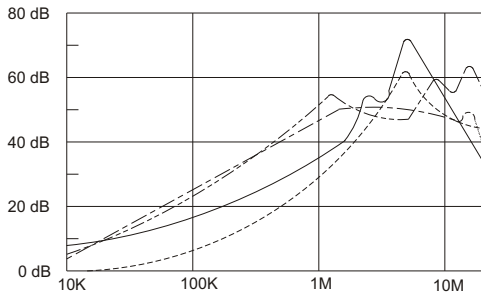

20DBAG5----- COMMON MODE ----- DIFF. MODE

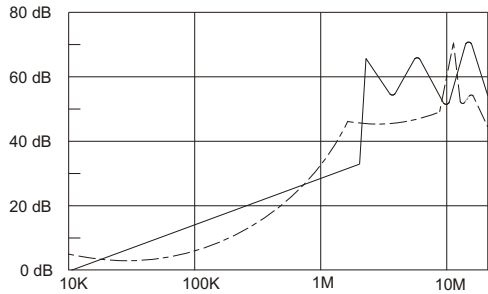

20DBC5B ----- COMMON MODE ----- DIFF. MODE
20BCS5B ----- COMMON MODE ----- DIFF. MODE
30BCS5B ----- COMMON MODE ----- DIFF. MODE

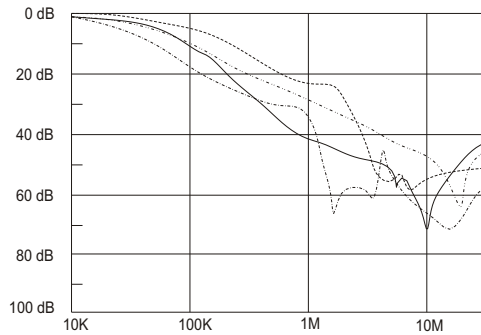

12DBBG5B ----- COMMON MODE ----- DIFF. MODE
12DBBW5B ----- COMMON MODE ----- DIFF. MODE

16DBC5B ----- COMMON MODE ----- DIFF. MODE
16DBCW5B ----- COMMON MODE ----- DIFF. MODE

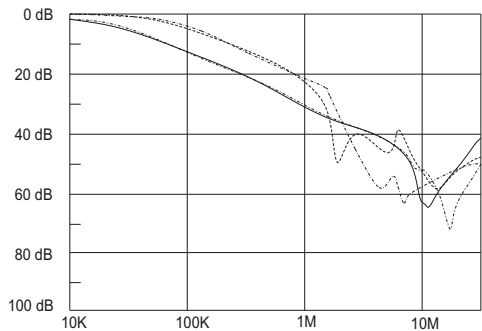

MECHANICAL CONSTRUCTION

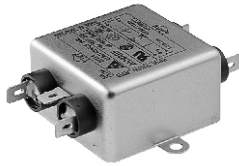

AG5

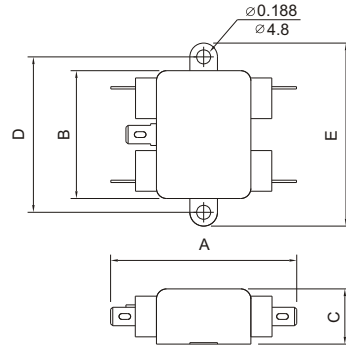

AW5

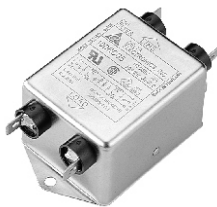
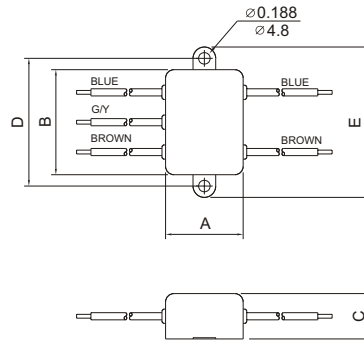

CG5

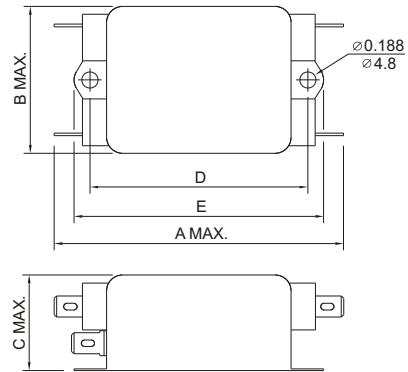

DW3S

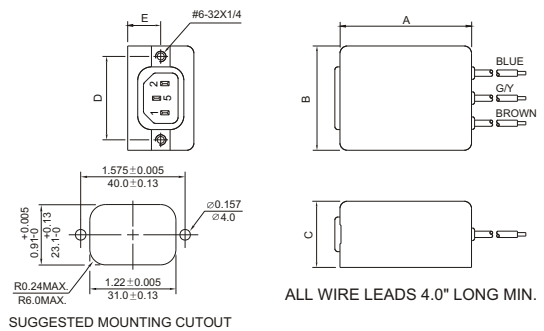

UNIT: INCH
mm

MECHANICAL CONSTRUCTION

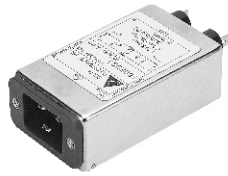

DG3

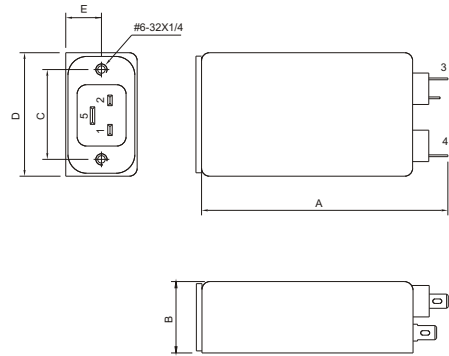

DG3S

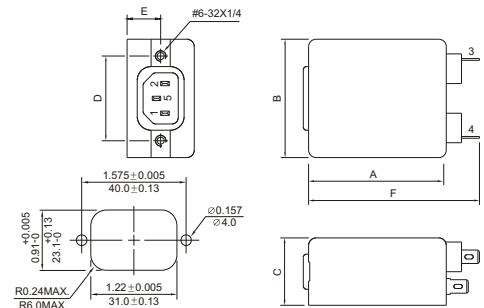

SUGGESTED MOUNTING CUTOUT



AS5

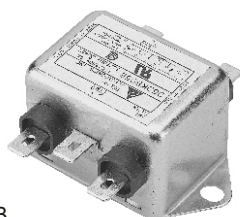
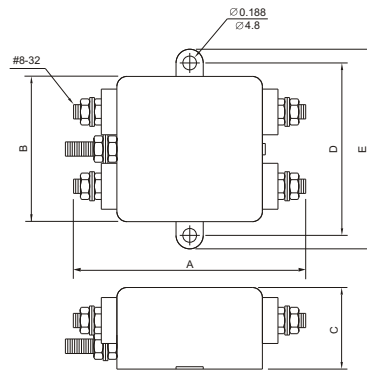

BG5B, BW5B
(option wire style)

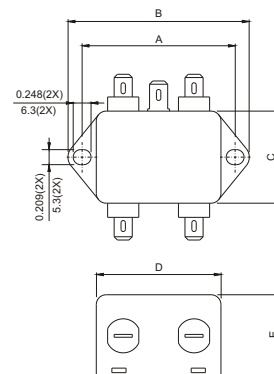

MECHANICAL CONSTRUCTION

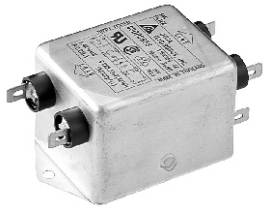

CG5B

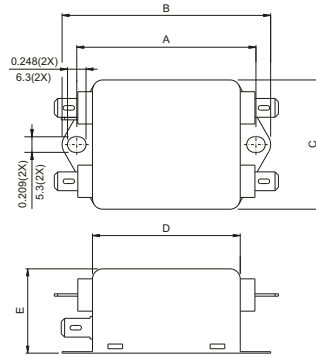

CW5B

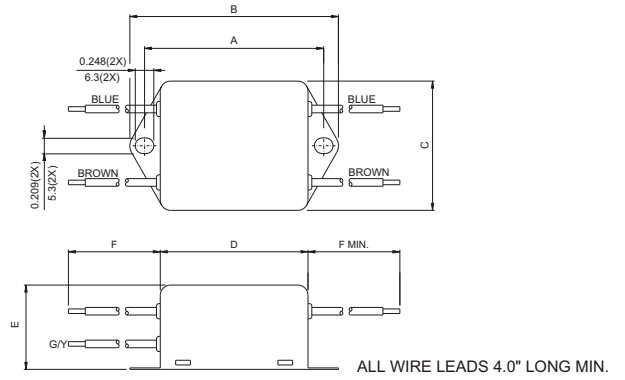

CS5B

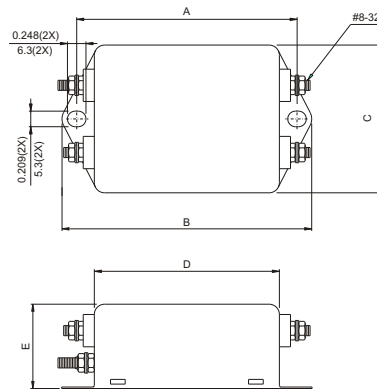

UNIT: $\frac{\text{INCH}}{\text{mm}}$

INTRODUCTIONS

- Effectively control EMI suppression of both line-to-line and line-to-ground noise.
- All part numbers are UL recognized, CSA certified and VDE approved.

COMPONENTS

PART NO.	C1 (uF)	C2 (uF)	L (mH)	Cy (pF)	R (Ω)
02DKAG5	0.22	0.22	2.1	3300	2.2M
02DKAW5					
03DKAG5					
03DKAW5					
03DKDG3S					
03DKDW3S					
05DKAG5					
05DKAS5					
05DKAW5					
05DKDG3S					
05DKDW3S					
10DKAG5					
10DKAS5					
10DKAW5					
10DKDG3S					
10DKDW3S					
15DKDG3	0.68X3	—	3.6	10000	200K
* 16DKCG5	0.47	0.47	6.0	10000	330K
20DKBG5	0.22	0.22	1.4	3300	2.2M
20DKBS5	0.22	0.22	1.4	3300	2.2M
30DKCS5	0.22	0.47	0.59	10000	470K

* DEMKO approved only

PART NO.	Cx (uF)	L (mH)	Cy (pF)	R (Ω)
03DKBG5B	0.15	2.5	4700	1.0M
03DKBW5B				
06DKBG5B				
06DKBW5B				
12DKBG5B				
12DKBW5B				
16DKCG5B				
16DKCW5B				
20DKCG5B				
20DKCS5B				
30DKCS5B	0.47	0.67	10000	470K

ELECTRICAL SCHEMATIC

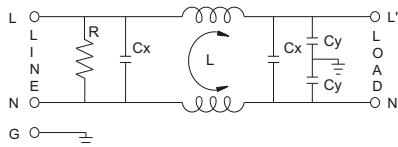
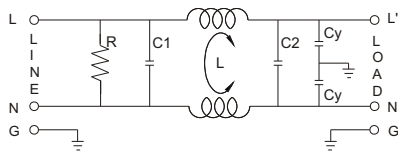

XXDKXX5B

SPECIFICATIONS

- Maximum leakage current each
 line-to-ground @ 115VAC 60Hz: 0.25mA
 1.0mA (10000pF)
 @ 250VAC 50Hz: 0.45mA
 2.0mA (10000pF)
- Hipot rating (one minute)
 line-to-ground: 2250VDC
 line-to-line: 1450VDC
- Operating frequency: 50/60Hz
- Rated voltage: 115/250VAC

MINIMUM INSERTION LOSS IN dB

COMMON MODE (L-G) IN 50 OHM SYSTEM							
CURRENT RATING	STYLE	FREQUENCY-MHz					
		.15	.50	1.0	5.0	10	30
2, 3, 5A		22	30	38	47	50	40
3A (S), 5A (S)		22	30	38	50	55	45
10A,10A (S)		15	20	28	45	45	45
15A		20	30	35	45	50	35
16A		25	35	40	45	45	20
20A		14	19	28	40	42	35
30A		10	20	30	40	45	30
DIFFERENTIAL MODE (L-L) IN 50 OHM SYSTEM							
2, 3, 5A		10	46	48	50	50	45
3A (S), 5A (S)		12	46	48	55	50	45
10A,10A (S)		8	38	55	45	45	45
15A		10	40	50	50	50	50
16A		20	50	50	50	40	30
20A		10	35	50	50	45	40
30A		10	30	50	45	35	40

COMMON MODE (L-G) IN 50 OHM SYSTEM							
CURRENT RATING	STYLE	FREQUENCY-MHz					
		.15	.50	1.0	5.0	10	30
3A	BG5B, BW5B	20	30	35	45	50	45
6A	BG5B, BW5B	15	20	25	40	45	45
12A	BG5B, BW5B	10	20	22	35	45	40
16A	CG5B, CW5B	10	18	20	35	45	30
20A	CG5B, CS5B	10	18	20	30	35	35
30A	CS5B	10	25	30	45	50	35
DIFFERENTIAL MODE (L-L) IN 50 OHM SYSTEM							
3A	BG5B, BW5B	7	35	50	45	45	45
6A	BG5B, BW5B	10	20	45	45	50	45
12A	BG5B, BW5B	10	20	40	45	45	45
16A	CG5B, CW5B	10	18	40	40	40	35
20A	CG5B, CS5B	10	12	35	35	40	40
30A	CS5B	12	40	50	50	50	45

SERIES DIMENSIONS

CURRENT RATING	STYLE	DIMENSIONS IN INCHES/mm				
		A	B	C	D	E
2A	AG5	2.99	2.04 51.8	0.90 22.9	2.38 60.5	2.79 70.9
		75.9				
AW5	1.83					
	46.5					
3A	AG5	2.99				
		75.9				
	AW5	1.83				
		46.5				
	DG3S	3.14				
DW3S	79.8					
5A	AG5	2.99				
		75.9				
	AW5	1.83				
		46.5				
	AS5	3.37				
	85.6					
3.14						
DG3S	79.8					
DW3S	2.55					
64.8						
10A	AG5	3.25				
		82.5				
	AW5	2.08				
		52.8				
	AS5	3.37				
	85.6					
DG3S	3.22					
81.5						
DW3S	2.63					
	66.8					
15A	DG3	4.35	2.22	1.29	1.575	0.63
		110.5	56.4	32.8	40.00	16.0
16A	CG5	3.75	2.06	1.54	2.94	3.34
		95.3	52.3	39.1	74.7	84.8
20A	BG5	3.25	2.52 64.0	1.54 39.1	2.94 74.7	3.36
		82.5				85.3
	BS5	3.37				3.37
		85.6				85.6
30A	CS5	3.87	2.04			3.36
		98.3	51.8			85.3

INSERTION LOSS (TYPICAL)

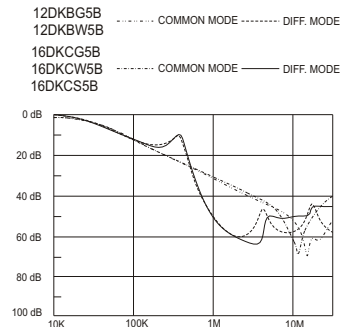
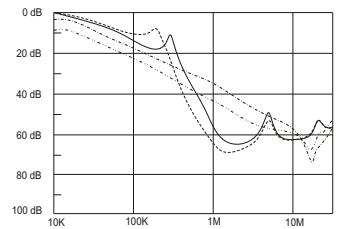
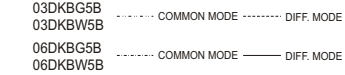
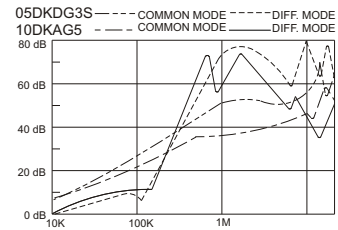
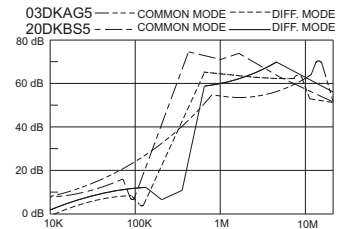
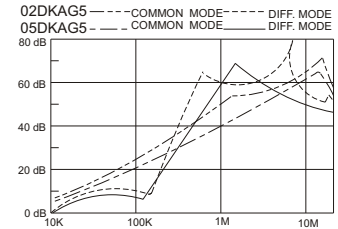

SERIES DIMENSIONS

CURRENT RATING	STYLE	DIMENSIONS IN INCHES/mm					
		A	B	C	D	E	F
3A	BG5B	2.13	2.54	1.34	1.77	1.18 30.0	-
	BW5B						$\frac{3.94}{100.0}$
6A	BG5B	54.00	64.5	34.0	45.0	1.18 30.0	-
	BW5B						$\frac{3.94}{100.0}$
12A	BG5B						-
	BW5B						$\frac{3.94}{100.0}$
16A	CG5B	61.00	71.5	45.5	51.3		-
	CW5B						$\frac{3.94}{100.0}$
20A	CG5B	75.00	84.8	51.8	64.0		-
	CS5B						
30A	CS5B	103.00	114.0	56.5	95.0	46.4	-

MECHANICAL CONSTRUCTION



AG5

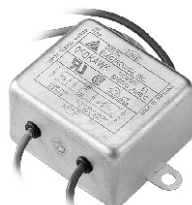
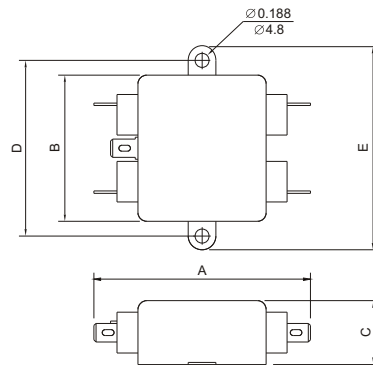

AW5

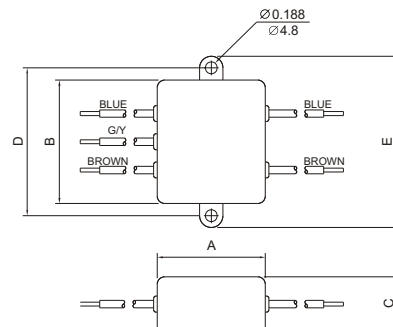

ALL WIRE LEADS 4.0" LONG MIN.

UNIT: $\frac{\text{INCH}}{\text{mm}}$

MECHANICAL CONSTRUCTION

AS5

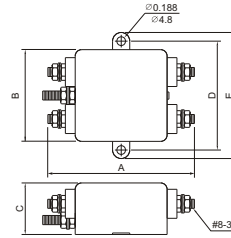

BG5

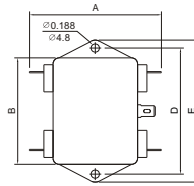
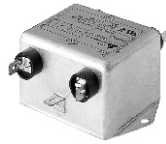

BS5

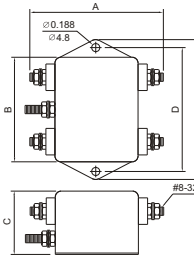

CG5

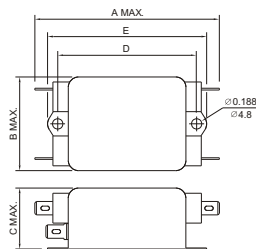

CS5

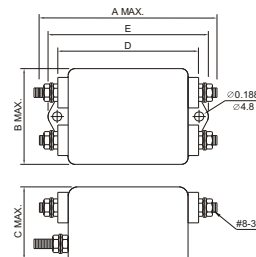

DG3S

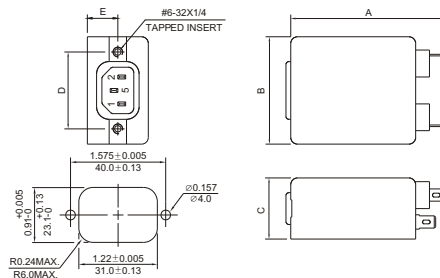

SUGGESTED MOUNTING CUTOUT

UNIT: INCH
mm

MECHANICAL CONSTRUCTION



DG3



DW3S

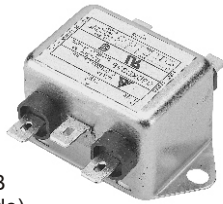

BG5B, BW5B
(option wire style)



CG5B



CW5B



CS5B

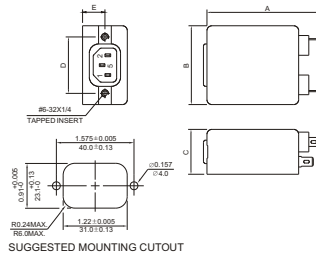

SUGGESTED MOUNTING CUTOUT

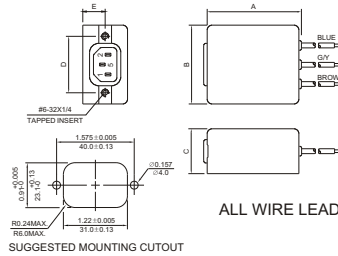

SUGGESTED MOUNTING CUTOUT

ALL WIRE LEADS 4.0" LONG MIN.

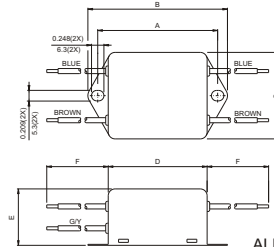
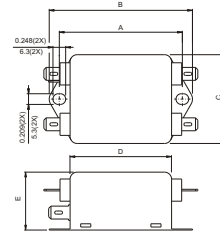
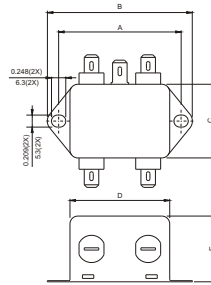

ALL WIRE LEADS 4.0" LONG MIN.

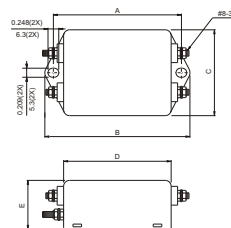



MK SERIES HIGH PERFORMANCE PC BOARD MOUNTING FILTERS



INTRODUCTIONS

1. Direct PC board mounting for easy installation.
2. All part numbers are UL recognized, CSA certified and VDE approved.
3. Optional medical version.

COMPONENTS

PART NO.	Cx (uF)	L (mH)	Cy (pF)	R
01MK4E	0.1	10	2200	1MΩ
03MK4E		2.5		
06MK4E		1		
10MK4E				

MINIMUM INSERTION LOSS IN dB

COMMON MODE (L-G) IN 50 OHM SYSTEM							
TYPE	CURRENT RATING	FREQUENCY-MHz					
		.15	.50	1.0	5.0	10	30
01MK4E	1A	30	50	40	40	35	20
03MK4E	3A	20	30	45	48	45	30
06MK4E	6A	15	25	30	45	40	30
10MK4E	10A	12	20	30	30	35	25

DIFFERENTIAL MODE (L-L) IN 50 OHM SYSTEM							
TYPE	CURRENT RATING	FREQUENCY-MHz					
		5	15	25	35	35	28
01MK4E	1A	5	25	40	40	40	20
03MK4E	3A	5	15	25	35	35	28
06MK4E	6A	5	12	20	20	30	25
10MK4E	10A	5	15	20	30	35	35

MECHANICAL CONSTRUCTION



MK4E

SPECIFICATIONS

1. Maximum leakage current each line-to-ground @115VAC 60Hz: 0.2mA @250VAC 50Hz: 0.4mA
2. Hipot rating (one minute) line-to-ground: 2250VDC line-to-line: 1450VDC
3. Operating frequency: 50/60 Hz
4. Rated voltage: 115/250VAC

ELECTRICAL SCHEMATIC

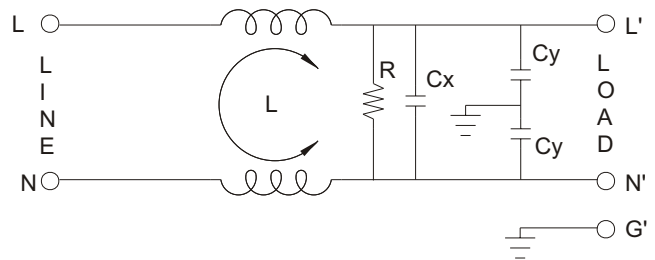

SERIES DIMENSIONS

PART NO.	DIMENSIONS IN INCHES/mm		
	A	B	C
01MK4E	0.65	0.03	0.04
03MK4E	16.5	0.8	1.1
06MK4E	0.79	0.047	0.06
10MK4E	20.0	1.2	1.5

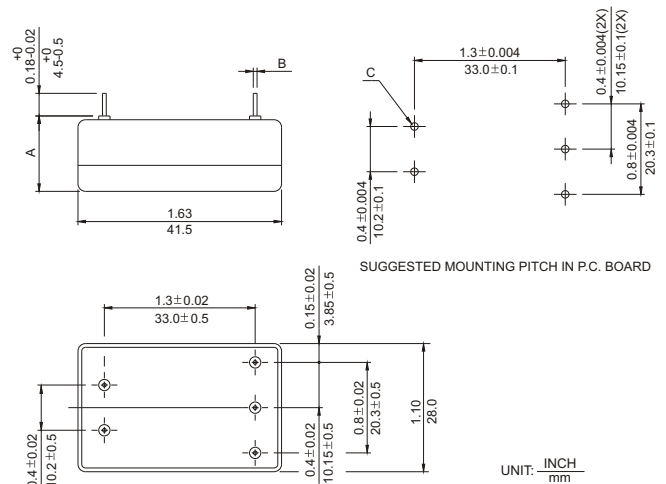

GENERAL PURPOSE ONE-STAGE FILTERS

INTRODUCTION

Two-stage filters provide high insertion loss for both line-to-line and line-to-ground emissions throughout the frequency range.

COMPONENTS

PART NO.	C1 (uF)	C2 (uF)	L1 (mH)	L2 (mH)
03DPCG5S	0.33	0.33	10	10
03DPCW5S				
03DPDG3S			6.5	4.5
03DPDW3S				
06DPCG5	0.47	0.47	2.7	14
06DPCW5			2.7	14
06DPDW3			8.0	2.83
10DPCG5			0.66	0.47

PART NO.	C1 (uF)	C2 (pF)	L1 (mH)	L2 (mH)	R (K)
03DPCG5B/W5B	0.47	4700	9.8	9.8	470
06DPCG5B/W5B	1.0		7.8	7.8	220
12DPCG5B/W5B			3.25	3.25	
16DPGG5B/W5B/S5B			2.8	2.8	

PART NO.	Cx (uF)	L1 (mH)	L2 (mH)	Cy (pF)	R (Ω)
03DPCG5C	0.22	2.5	2.5	4700	1.0M
03DPCW5C					
06DPCG5C		0.97	0.97		
06DPCW5C					
12DPCG5C	0.47	0.58	0.58		470K
12DPCW5C					
16DPCG5C	0.33	0.65	0.65		1.0M
16DPCW5C					
16DPCS5C		1.0	0.60	0.60	
20DPCG5C					
20DPCS5C	1.0	0.60	0.60	220K	
30DPGS5C					10000

ELECTRICAL SCHEMATIC

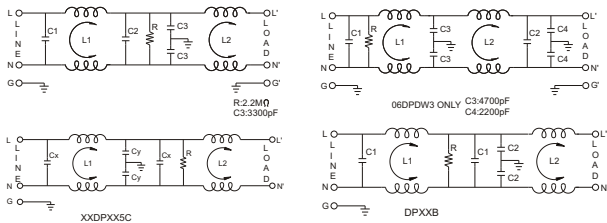

SPECIFICATIONS

- Maximum leakage current each
line-to-ground @ 115VAC 60Hz: 0.4mA (4700pF)
@ 250VAC 50Hz: 0.8mA (4700pF)
@ 115VAC 60Hz: 1.0mA (10000pF)
@ 250VAC 50Hz: 2.0mA (10000pF)
- Hipot rating (one minute)
line-to-ground: 2250VDC
line-to-line: 1450VDC
- Operating frequency: 50/60Hz
- Rated voltage: 115/250VAC

MINIMUM INSERTION LOSS IN dB

COMMON MODE (L-G) IN 50 OHM SYSTEM						
CURRENT RATING	FREQUENCY-MHz					
	.15	.50	1.0	5.0	10	30
3A(S)	50	70	70	60	50	40
3A	60	70	70	65	55	40
6A	58	70	65	65	60	50
10A	48	65	60	45	35	20
•06DPDW3	55	60	60	60	60	60
03DPCG5B/W5B	60	70	65	50	45	25
06DPCG5B/W5B	50	60	60	60	60	35
12DPCG5B/W5B	45	60	65	65	65	45
16DPGG5B/W5B/S5B	20	35	40	50	40	30
DIFFERENTIAL MODE (L-L) IN 50 OHM SYSTEM						
3A(S)	35	48	55	55	55	45
3A	36	55	60	55	55	45
6A	40	65	65	70	70	50
10A	30	40	45	55	60	25
03DPCG5B/W5B	30	45	45	45	45	25
•06DPDW3	40	60	60	60	60	60
06DPCG5B/W5B	45	50	50	55	55	45
12DPCG5B/W5B	45	45	50	50	50	50
16DPGG5B/W5B/S5B	7	55	50	50	50	40

- Maximum leakage current
 - 115VAC 60Hz: 0.5mA
 - 250VAC 50Hz: 1.0mA

COMMON MODE (L-G) IN 50 OHM SYSTEM							
CURRENT RATING	STYLE	FREQUENCY-MHz					
		.15	.50	1.0	5.0	10	30
3A	CG5C, CW5C	45	60	60	55	45	35
6A	CG5C, CW5C	30	50	60	55	50	35
12A	CG5C, CW5C	15	25	35	55	55	35
16A	CG5C, CW5C, CS5C	20	35	45	60	50	35
20A	CG5C, CS5C	15	40	45	50	50	40
30A	GS5C	10	30	35	55	45	30
DIFFERENTIAL MODE (L-L) IN 50 OHM SYSTEM							
3A	CG5C, CW5C	12	45	45	45	45	45
6A	CG5C, CW5C	8	45	45	45	45	45
12A	CG5C, CW5C	12	40	40	35	35	40
16A	CG5C, CW5C, CS5C	12	40	40	45	45	50
20A	CG5C, CS5C	12	45	45	40	35	50
30A	GS5C	18	45	50	40	40	40

GENERAL PURPOSE TWO-STAGE FILTERS

SERIES DIMENSIONS

CURRENT RATING	DIMENSIONS IN INCHES/mm					
	STYLE	A	B	C	D	E
3A	CG5S	$\frac{2.94}{74.7}$	$\frac{3.36}{85.3}$	$\frac{2.04}{51.8}$	$\frac{2.52}{64.0}$	$\frac{1.77}{45.0}$
3A	CW5S					
3A	DG3S	$\frac{2.55}{64.8}$	$\frac{2.04}{51.8}$	$\frac{1.77}{45.0}$	$\frac{1.575}{40.0}$	$\frac{0.63}{16.0}$
3A	DW3S					
6A	CG5					
6A	CW5	$\frac{5.63}{143.0}$	$\frac{6.02}{152.9}$	$\frac{2.02}{51.3}$	$\frac{5.27}{133.86}$	$\frac{2.77}{70.4}$
10A	CG5					
6A	DW3	$\frac{3.10}{78.7}$	$\frac{2.08}{52.8}$	$\frac{1.79}{45.5}$	$\frac{1.575}{40.0}$	$\frac{0.63}{16.0}$

CURRENT RATING	DIMENSIONS IN INCHES/mm							
	STYLE	A	B	C	D	E	F	G
3A	CG5B, CW5B	$\frac{2.95}{75.0}$	$\frac{3.34}{84.8}$	$\frac{2.05}{52.0}$	$\frac{2.58}{65.6}$	$\frac{1.54}{39.2}$	$\frac{4\text{min}}{101.6}$	
6A	CG5B, CW5B	$\frac{4.06}{103.0}$	$\frac{4.49}{114.0}$	$\frac{2.22}{56.5}$	$\frac{3.76}{95.5}$	$\frac{1.83}{46.4}$		
12A	CG5B, CW5B	$\frac{5.63}{143.0}$	$\frac{6.02}{152.9}$	$\frac{2.05}{52.0}$	$\frac{5.30}{134.7}$	$\frac{1.78}{45.3}$		
16A	GS5B	$\frac{3.89}{99.0}$	$\frac{4.31}{109.5}$	$\frac{4.72}{120.0}$	$\frac{2.0}{51.0}$	$\frac{2.62}{66.5}$	$\frac{3.38}{86.0}$	$\frac{2.28}{58.0}$

CURRENT RATING	DIMENSIONS IN INCHES/mm							
	STYLE	A	B	C	D	E	F	G
3A	CG5C, CW5C	$\frac{3.0}{75.0}$	$\frac{3.34}{84.8}$	$\frac{2.05}{52.0}$	$\frac{2.58}{65.6}$	$\frac{1.54}{39.2}$	$\frac{4\text{min}}{101.6}$	
6A	CG5C, CW5C	$\frac{5.63}{143.0}$	$\frac{6.02}{152.91}$	$\frac{2.02}{51.31}$	$\frac{5.27}{133.86}$	$\frac{2.27}{57.66}$		
12A	CG5C, CW5C	$\frac{3.0}{75.0}$	$\frac{3.34}{84.8}$	$\frac{2.05}{52.0}$	$\frac{2.58}{65.6}$	$\frac{1.15}{29.2}$		
20A	CG5C, CW5C	$\frac{4.05}{103}$	$\frac{4.49}{114}$	$\frac{2.22}{56.5}$	$\frac{3.76}{95.5}$	$\frac{1.86}{46.4}$		
30A	GS5C	$\frac{3.90}{99.0}$	$\frac{4.31}{109.5}$	$\frac{4.72}{120.0}$	$\frac{2.01}{51.0}$	$\frac{2.62}{66.5}$	$\frac{3.39}{86.0}$	$\frac{2.28}{58.0}$

INSERTION LOSS (TYPICAL)

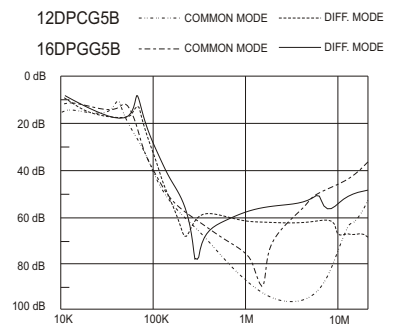
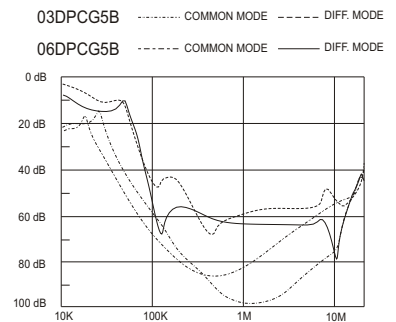
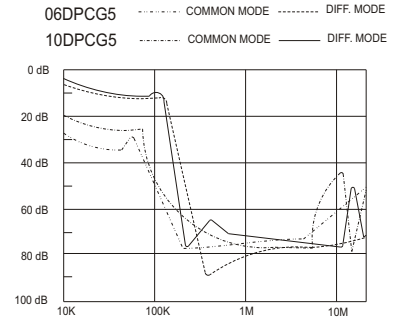
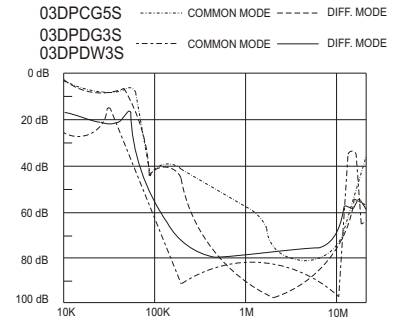

GENERAL PURPOSE TWO-STAGE FILTERS

MECHANICAL CONSTRUCTION

CG5S

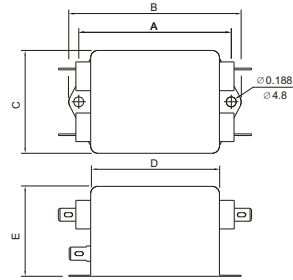
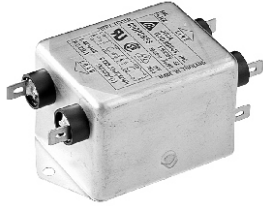

CG5

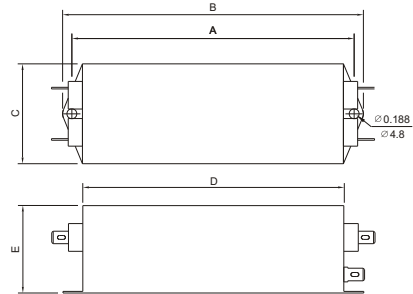

DG3S

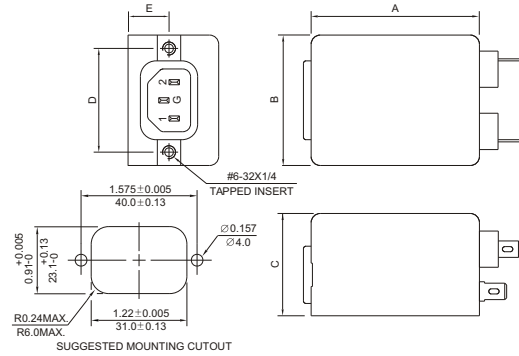

DW3/DW3S

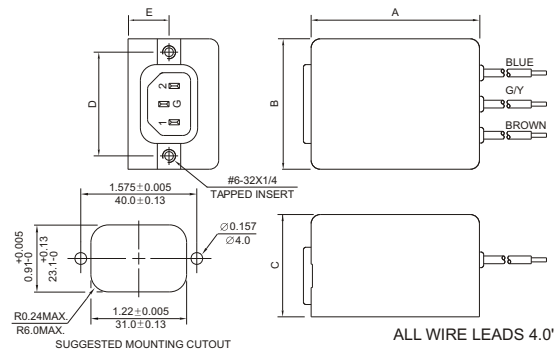

ALL WIRE LEADS 4.0" LONG MIN.

GS5B/GS5C

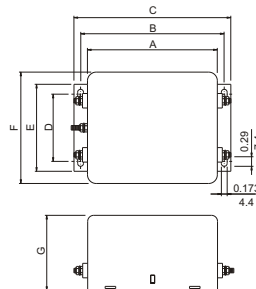
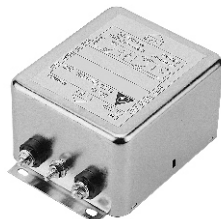

GENERAL PURPOSE TWO-STAGE FILTERS

MECHANICAL CONSTRUCTION

GG5B

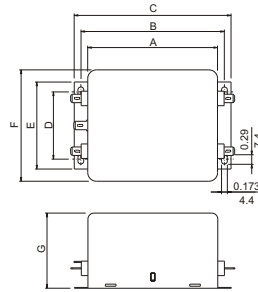

GW5B

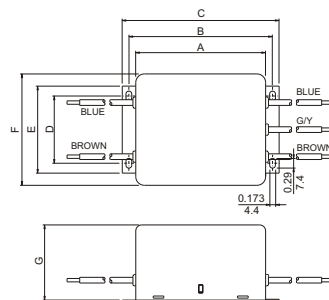
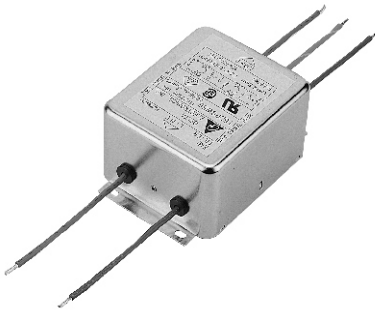

ALL WIRE LEADS 4.0" LONG MIN.

CG5B/CG5C

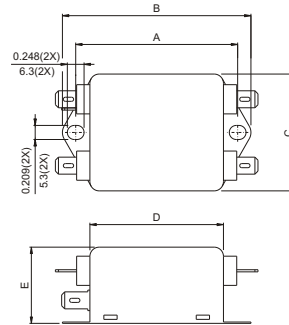
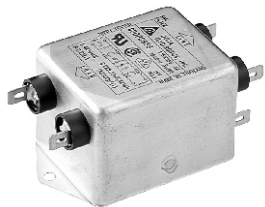

CW5/CW5B/CW5S/CW5C

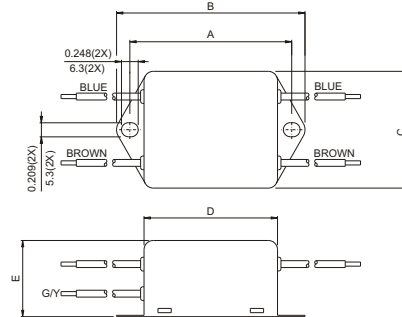

ALL WIRE LEADS 4.0" LONG MIN.

CS5C

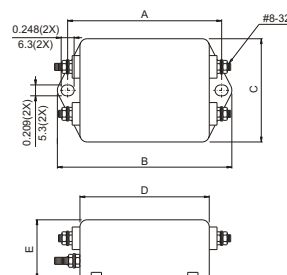

UNIT: INCH
mm

INTRODUCTIONS

1. Two-stage filters provide high insertion loss for both line-to-line and line-to-ground emissions throughout the frequency range.

COMPONENTS

PART NO.	C1 (uF)	C2 (pF)	L1 (mH)	L2 (uH)	R (K Ω)
03DCCG5B/W5B	0.47	4700	9.8	160	470
06DCCG5B/W5B	1.0		7.8	110	220
12DCCG5B/W5B			3.25	50	
16DCCG5B/W5B/S5B			2.8	43	

SERIES DIMENSIONS

PART NO.	DIMENSIONS IN INCHES/mm						
	A	B	C	D	E	F	G
03DCCG5B/W5B	2.95 75.0	3.34 84.8	2.05 52.0	2.58 65.6	1.54 39.2		
06DCCG5B/W5B	4.06 103.0	4.49 114.0	2.22 56.5	3.76 95.5	1.83 46.4		
12DCCG5B/W5B	5.63 143.0	6.02 152.9	2.05 52.0	5.30 134.7	1.78 45.3		
16DCCG5B/S5B/W5B	3.90 99.0	4.31 109.5	4.72 120.0	2.01 51.0	2.62 66.5	3.39 86.0	2.28 58.0

MINIMUM INSERTION LOSS IN dB

COMMON MODE (L-G) IN 50 OHM SYSTEM						
CURRENT RATING	FREQUENCY-MHz					
	.15	.50	1.0	5.0	10	30
3A	25	45	55	55	55	35
6A	25	45	50	60	60	40
12A	20	30	40	55	60	25
16A	15	20	30	60	50	30
DIFFERENTIAL MODE (L-L) IN 50 OHM SYSTEM						
3A	45	60	60	70	70	50
6A	50	60	60	60	60	50
12A	35	55	60	60	60	45
16A	40	55	55	60	60	50

SPECIFICATIONS

- Maximum leakage current each line-to-ground @ 115VAC 60Hz: 0.40mA
@ 250VAC 50Hz: 0.80mA
- Hipot rating (one minute)
line-to-ground: 2250VDC
line-to-line: 1450VDC
- Operating frequency: 50/60Hz
- Rated voltage: 115/250VAC

ELECTRICAL SCHEMATIC

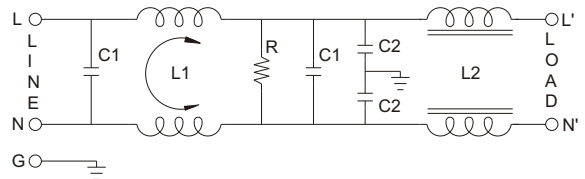

INSERTION LOSS (TYPICAL)

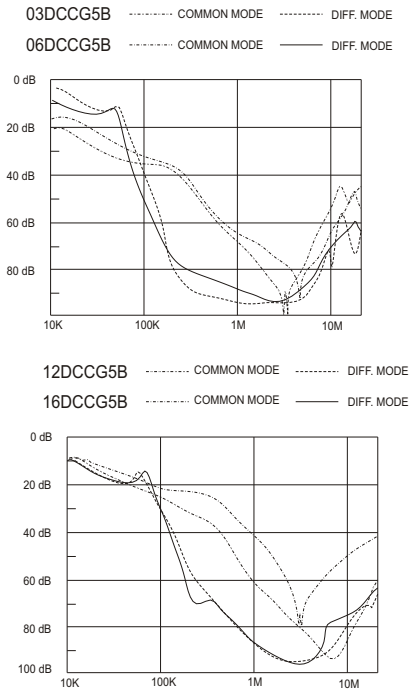

MECHANICAL CONSTRUCTION

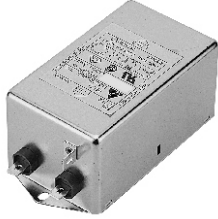

CG5B

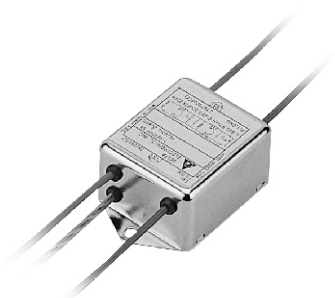
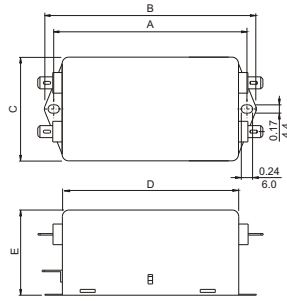

CW5B

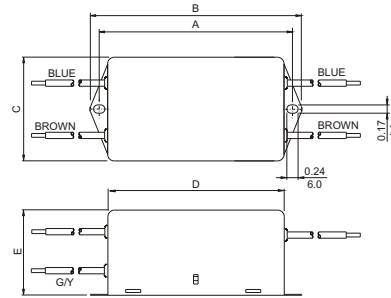

ALL WIRE LEADS 4.0" LONG MIN.



GG5B

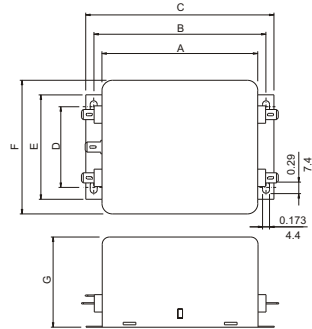

GS5B

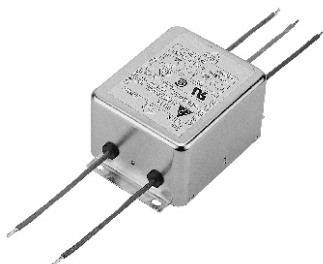
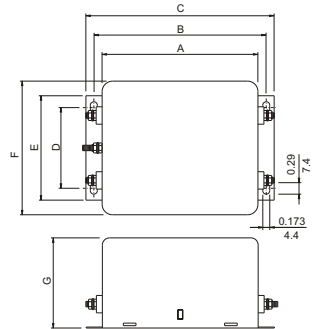

GW5B

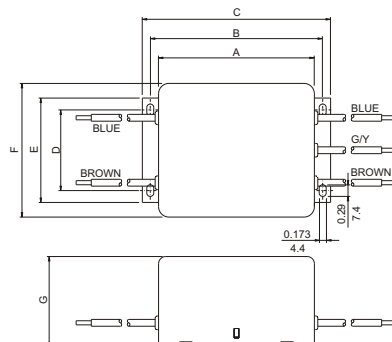

ALL WIRE LEADS 4.0" LONG MIN.

UNIT: $\frac{\text{INCH}}{\text{mm}}$

INTRODUCTIONS

- Two-stage filters provide high performance in suppressing both line-to-line and line-to-ground noise.
- All part numbers are UL recognized, CSA certified and VDE approved.

COMPONENTS

PART NO.	C1,C2,C3(μF)	L1,L2(mH)
02DRCG5	0.1	2.4
02DRCW5		
03DRCG5	0.22	1.7
03DRCW5		
03DRDG3S		2.8
03DRDW3S		
05DRCG5		
05DRCW5	1.6	
05DRDG3		
05DRDG3S	2.7	
05DRDW3S		
05DRDW3S		
10DRCG5	0.22	1.0
10DRCS5		
10DRCW5		
10DRDG3		
10DRDG3		
*15DRCG5	0.1	0.9
•20DRGG5	0.22	1.0
•20DRGS5		

R: 2.2MΩ, Cy: 3300pF.
 * No safety approval yet, R: 1.0MΩ
 • VDE approved to 16A/250VAC, C2: 0.33 μF

ELECTRICAL SCHEMATIC



SPECIFICATIONS

- Maximum leakage current each line-to-ground @ 115VAC 60Hz: 0.25mA @ 250VAC 50Hz: 0.45mA
- Hipot rating (one minute) line-to-ground: 2250VDC line-to-line: 1450VDC
- Operating frequency: 50/60Hz
- Rated voltage: 115/250VAC

SERIES DIMENSIONS

PART NO.	DIMENSIONS IN INCHES/mm				
	A	B	C	D	E
02DRCG5	3.25	1.82	1.15	2.38	2.77
	82.5				70.4
02DRCW5	2.08	46.2	29.2	60.5	2.77
	52.8				70.4
03DRCG5	3.75	2.02	29.2	2.94	3.34
	95.2	51.3			84.8
03DRCW5	2.58	2.04	29.2	74.7	3.34
	65.5	51.8			84.8
03DRDG3S	3.14	2.02	32.5	1.575	0.61
	79.8				15.5
03DRDW3S	2.55	51.3	32.5	40.00	0.61
	64.8				15.5
05DRCG5	3.75	2.04	29.2	2.94	3.34
	95.2				84.8
05DRCW5	2.58	2.04	29.2	74.7	3.34
	65.5	51.8			84.8
05DRDG3	4.33	2.20	32.3	1.575	0.63
	110.0	55.9			16.0
05DRDG3S	3.14	2.02	32.3	40.00	0.61
	79.8				15.5
05DRDW3S	2.55	51.3	32.3	40.00	0.61
	64.8				15.5
10DRCG5	3.75	2.22	32.3	1.575	0.63
	95.2				56.4
10DRCS5	3.87	2.08	38.6	74.4	3.34
	98.3				84.5
10DRCW5	2.50	52.8	29.2	74.7	3.36
	63.5				85.3
10DRDG3	4.35	2.22	32.3	40.01	0.63
	110.5	56.4			16.0
15DRCG5	3.75	2.08	45.5	74.7	3.36
	95.2	52.8			85.3
20DRGG5	5.14	3.33	38.6	3.75	4.14
	130.5	84.6			95.3
20DRGS5	130.5	84.6	38.6	95.3	105.1

GENERAL PURPOSE TWO-STAGE FILTERS

INSERTION LOSS (TYPICAL)

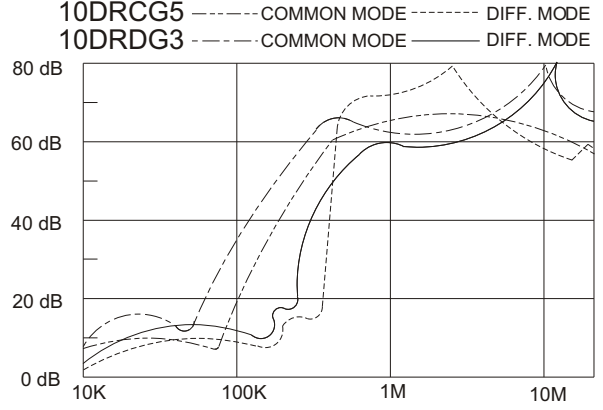
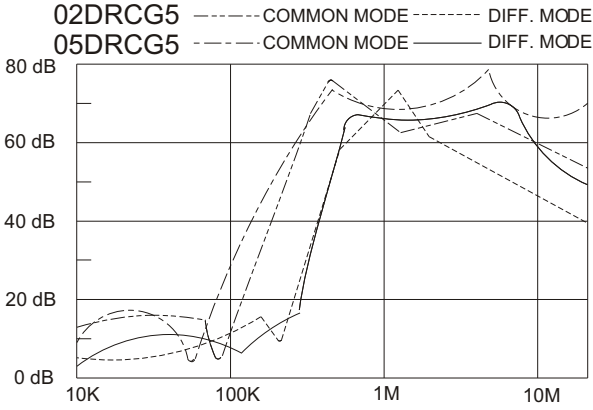

MINIMUM INSERTION LOSS IN dB

COMMON MODE (L-G) IN 50 OHM SYSTEM						
CURRENT RATING	FREQUENCY-MHz					
	.15	.50	1.0	5.0	10	30
2	40	60	65	55	50	40
3, 5A	40	60	65	65	60	45
3, 5A(S)	38	60	65	55	45	40
10A	30	60	65	50	45	40
15A	23	45	50	45	40	30
20A	20	35	40	50	55	40
DIFFERENTIAL MODE (L-L) IN 50 OHM SYSTEM						
2	5	50	65	60	54	46
3, 5A	12	60	65	60	54	46
3, 5A(S)	10	65	70	70	60	50
10A	7	53	60	55	45	40
15A	8	30	40	45	40	40
20A	7	55	50	50	55	40

MECHANICAL CONSTRUCTION



CW5

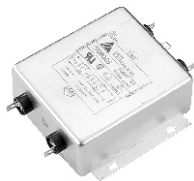

GG5

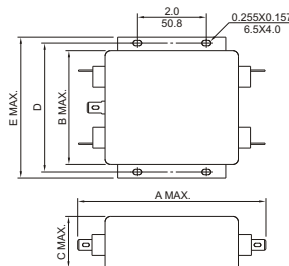
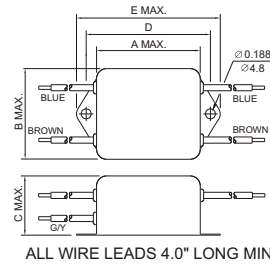

UNIT: $\frac{\text{INCH}}{\text{mm}}$

MECHANICAL CONSTRUCTION

GS5

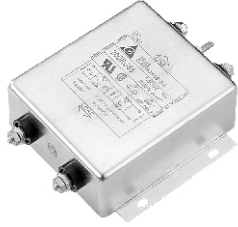

CG5

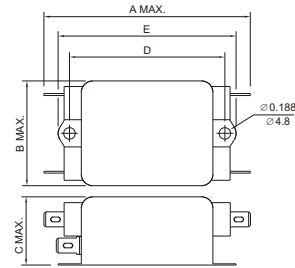

CS5



DG3/DG3S



DW3S



GENERAL PURPOSE TWO-STAGE FILTERS



DS SERIES MULTI-PURPOSE POWER LINE FILTERS



INTRODUCTION

Two-stage filters are for susceptibility use when equipment impedance at radiation frequency is low.

COMPONENTS

PART NO.	C1 (uF)	C2 (uF)	L1 (uH)	L2 (mH)	Cy (pF)	R (Ω)
03DSCG5	0.22	0.22	30	1.0	5500	330K
06DSCG5			70	1.7		
10DSCG5			40	1.2		
20DSGG5	0.55		30	0.93		

MINIMUM INSERTION LOSS IN dB

COMMON MODE (L-G) IN 50 OHM SYSTEM							
CURRENT RATING	FREQUENCY-MHz						
	.15	.50	1.0	5.0	10	30	
3A	12	25	30	45	60	35	
6A	25	30	30	35	50	45	
• 10A	15	20	25	40	45	40	
** 20A	12	20	30	35	40	40	

DIFFERENTIAL MODE (L-L) IN 50 OHM SYSTEM							
CURRENT RATING	.15	.50	1.0	5.0	10	30	
3A	20	50	60	45	45	45	
6A	30	25	40	40	40	40	
• 10A	25	50	50	45	45	45	
** 20A	25	60	60	50	50	45	

• VDE approved in 8A
 ** VDE approved in 16A

INSERTION LOSS (TYPICAL)

03DSCG5 ----- COMMON MODE ----- DIFF. MODE
 06DSCG5 ----- COMMON MODE ----- DIFF. MODE

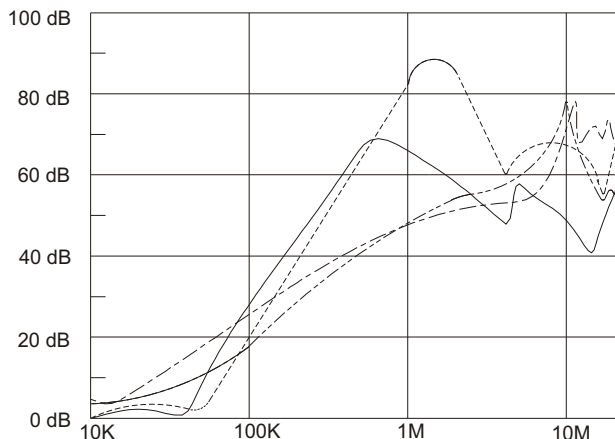

SPECIFICATIONS

- Maximum leakage current each
 line-to-ground: @ 115VAC 60Hz: 0.45mA
 @ 250VAC 50Hz: 0.90mA
- Hipot rating (one minute)
 line-to-ground: 2250VDC
 line-to-line: 1450VDC
- Operating frequency: 50/60Hz
- Rated voltage: 115/250VAC

SERIES DIMENSIONS

PART NO.	DIMENSIONS IN INCHES/mm				
	A	B	C	D	E
03DSCG5	3.25 82.5	1.90 48.3	1.15 29.2	2.38 60.5	2.77 70.4
06DSCG5	3.75	2.06	1.54	2.94	3.34
10DSCG5	95.2	52.3		74.7	84.8
20DSGG5	5.25 130.5	3.40 86.4	39.1	3.75 95.3	4.14 105.1

GENERAL PURPOSE TWO-STAGE FILTERS

10DSCG5 ----- COMMON MODE ----- DIFF. MODE
 20DSGG5 ----- COMMON MODE ----- DIFF. MODE

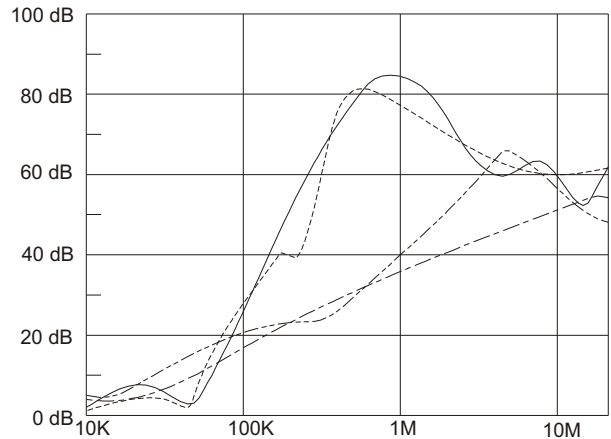

ELECTRICAL SCHEMATIC

3A. 6A. 10A.

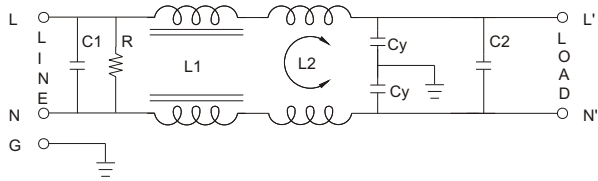

20A.

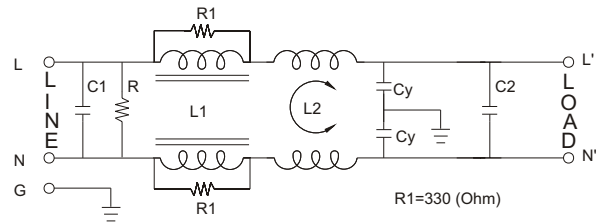

MECHANICAL CONSTRUCTION

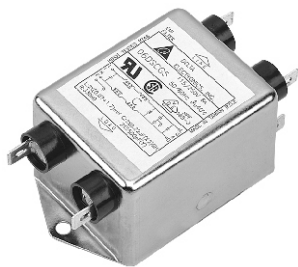

CG5

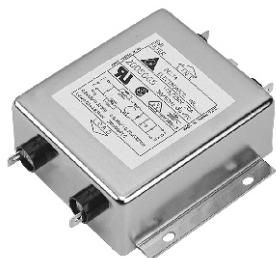
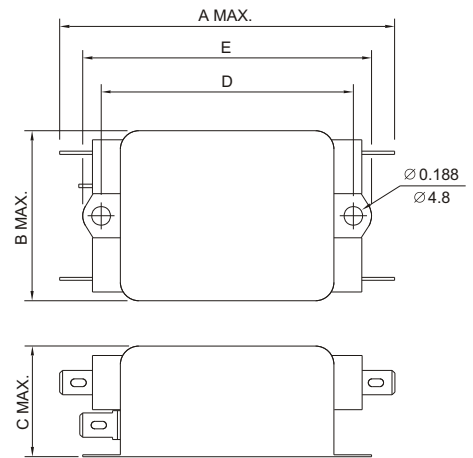

GG5

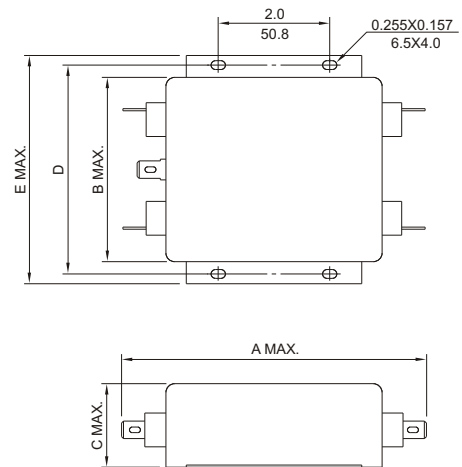

UNIT: INCH
mm



DV SERIES MULTI-PURPOSE POWER LINE FILTERS



INTRODUCTIONS

Two-stage filters are for susceptibility use when equipment impedance at radiation frequency is low.

COMPONENTS

PART NO.	C1 (uF)	C2 (uF)	L1 (mH)	L2 (uH)	Cy (pF)	R (Ω)
03DVCG5	0.22	0.22	1.0	30	5500	330K
06DVCG5			1.7	70		
10DVCG5			1.2	40		
20DVGG5		0.47	1.73	30		

MINIMUM INSERTION LOSS IN dB

COMMON MODE (L-G) IN 50 OHM SYSTEM							
CURRENT RATING	FREQUENCY-MHz						
	.15	.50	1.0	5.0	10	30	
3A	12	25	35	50	45	40	
6A	23	40	50	55	55	40	
* 10A	10	20	30	50	45	35	
** 20A	20	20	35	45	45	30	

DIFFERENTIAL MODE (L-L) IN 50 OHM SYSTEM							
CURRENT RATING	.15	.50	1.0	5.0	10	30	
3A	30	50	60	60	70	50	
6A	25	35	50	55	55	50	
* 10A	25	55	60	60	55	55	
** 20A	25	50	50	50	45	45	

* VDE approved in 8A
 ** VDE approved in 16A

INSERTION LOSS (TYPICAL)

03DVCG5 --- COMMON MODE --- DIFF. MODE
 06DVCG5 --- COMMON MODE --- DIFF. MODE

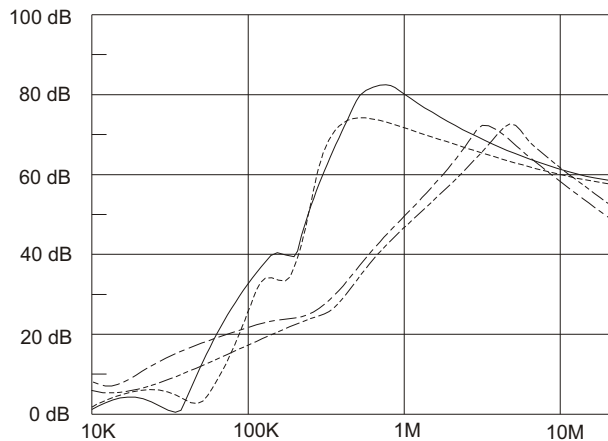

SPECIFICATIONS

- Maximum leakage current each line-to-ground: @115VAC 60Hz: 0.45mA
 @250VAC 50Hz: 0.90mA
- Hipot rating (one minute)
 line-to-ground: 2250VDC
 line-to-line: 1450VDC
- Operating frequency: 50/60Hz
- Rated voltage: 115/250VAC

SERIES DIMENSIONS

PART NO.	DIMENSIONS IN INCHES/mm				
	A	B	C	D	E
03DVCG5	3.25	1.90	1.15	2.38	2.77
	82.5	48.3	29.2	60.5	70.4
06DVCG5	3.75	2.06	1.54	2.94	3.34
	95.2	52.3		74.7	84.8
20DVGG5	5.25	3.40	39.1	3.75	4.14
	130.5	86.4		95.3	105.1

GENERAL PURPOSE TWO-STAGE FILTERS

10DVCG5 --- COMMON MODE --- DIFF. MODE
 20DVGG5 --- COMMON MODE --- DIFF. MODE

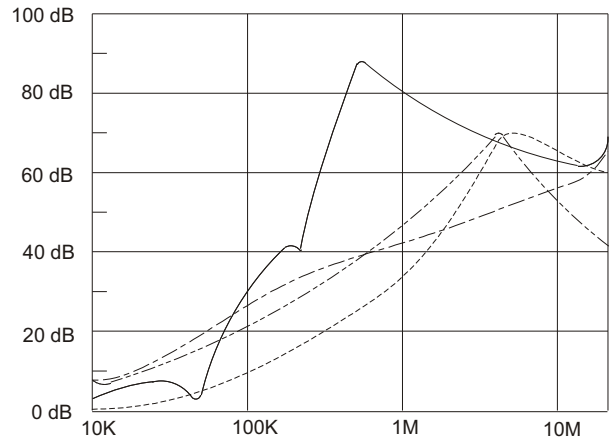

ELECTRICAL SCHEMATIC

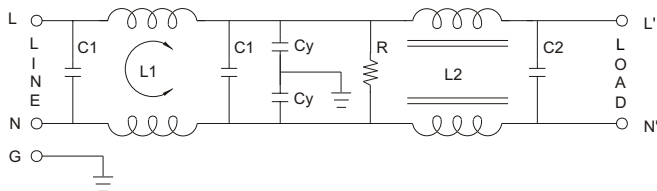

MECHANICAL CONSTRUCTION

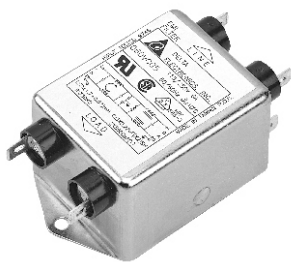

CG5

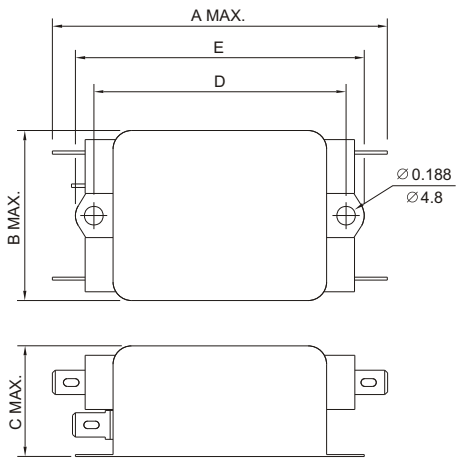

GG5

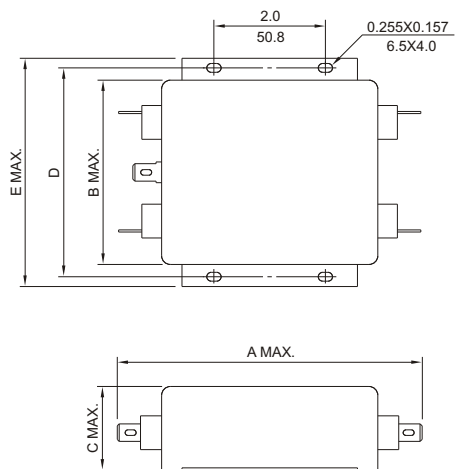

UNIT: INCH
mm



DW SERIES

MULTI-PURPOSE POWER LINE FILTERS



INTRODUCTION

Two-stage filters providing excellent suppression at high frequency.

COMPONENTS

PART NO.	C1 (uF)	C2 (uF)	L1 (mH)	L2 (uH)	Cy (pF)	R (Ω)
03DWCG5	0.22	0.22	1.0	30	3300	330K
06DWCG5			1.7	70		
10DWCG5			1.2	40		
20DWGG5		0.47	1.73	30		

MINIMUM INSERTION LOSS IN dB

COMMON MODE (L-G) IN 50 OHM SYSTEM						
CURRENT RATING	FREQUENCY-MHz					
	.15	.50	1.0	5.0	10	30
3A	12	20	30	60	60	45
6A	25	30	45	55	55	45
• 10A	15	20	30	60	55	45
• 20A	20	25	30	55	55	45
DIFFERENTIAL MODE (L-L) IN 50 OHM SYSTEM						
3A	25	50	60	45	50	50
6A	25	35	50	50	50	45
• 10A	25	50	50	45	45	45
• 20A	25	55	55	55	50	45

• VDE approved in 8A
• VDE approved in 16A

SPECIFICATIONS

1. Maximum leakage current each line-to-ground: @ 115VAC 60Hz: 0.50mA
@ 250VAC 50Hz: 1.00mA
2. Hipot rating (one minute) line-to-ground: 2250VDC
line-to-line: 1450VDC
3. Operating frequency: 50/60Hz
4. Rated voltage: 115/250VAC

SERIES DIMENSIONS

PART NO.	DIMENSIONS IN INCHES/mm				
	A	B	C	D	E
03DWCG5	3.25	1.90	1.15	2.38	2.77
	82.5	48.3	29.2	60.5	70.4
06DWCG5	3.75	2.06	1.54	2.94	3.34
10DWCG5	95.2	52.3		74.7	84.8
20DWGG5	5.25	3.40	39.1	3.75	4.14
	130.5	86.4	95.3	95.3	105.1

INSERTION LOSS (TYPICAL)

03DWCG5 --- COMMON MODE --- DIFF. MODE
06DWCG5 --- COMMON MODE --- DIFF. MODE

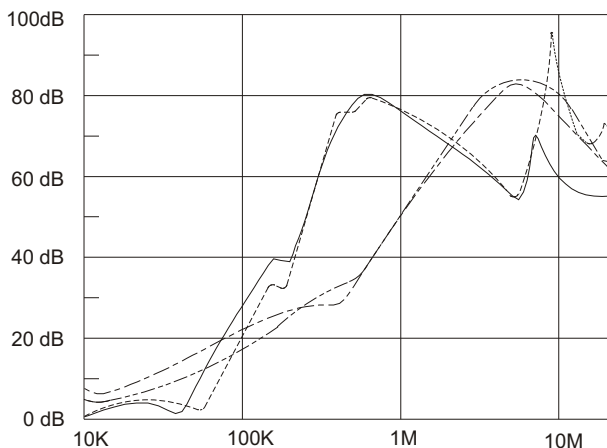

10DWCG5 --- COMMON MODE --- DIFF. MODE
20DWGG5 --- COMMON MODE --- DIFF. MODE

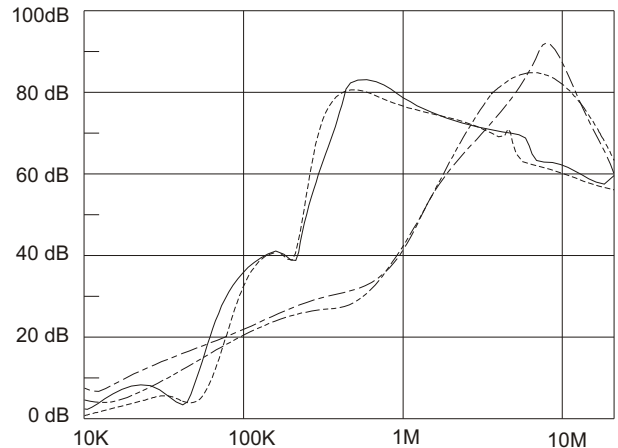

GENERAL PURPOSE TWO-STAGE FILTERS

ELECTRICAL SCHEMATIC

3A. 6A. 10A.

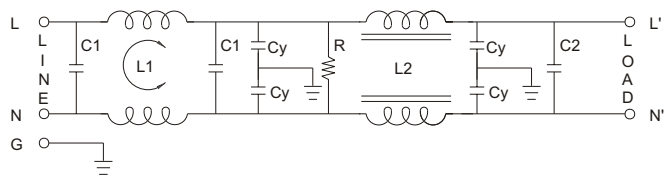

20A.

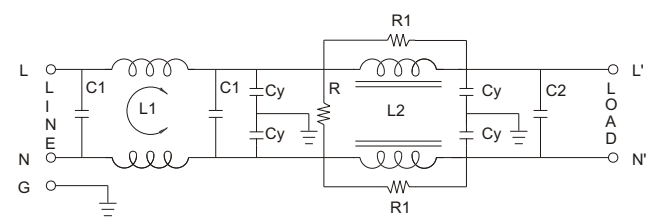

R1=330(Ohm)

MECHANICAL CONSTRUCTION



CG5

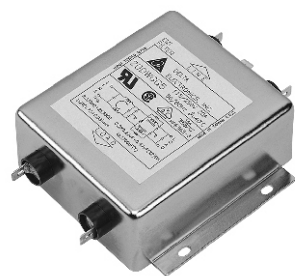



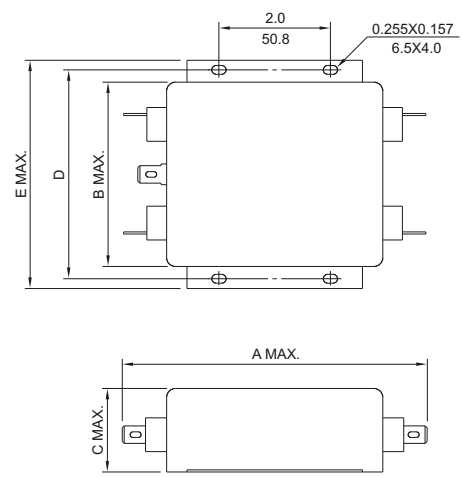
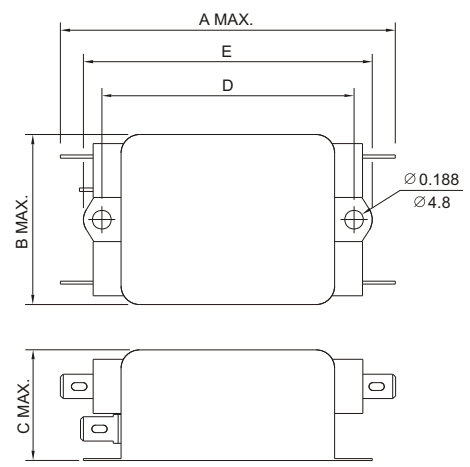

GG5





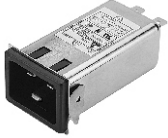

UNIT: INCH
mm

Medical Filter



DE & GE Series IEC INLET FILTERS

PRODUCT TYPE	EG3BM/EG3QM	NG3QM	NG3QM(H)	20GEEG3EM	20GENG3EM
PICTURE					
CURRENT RATING	1/3/6/10A	3/6/10A	3/6/10A	20A	20A



KE / KEN Series HIGH PERFORMANCE IEC INLET / SNAP-IN FILTERS

PRODUCT TYPE	G3EAM/G3SAM	W3EAM/W3SAM	G3EAM/G3SAM	W3EAM/W3SAM
PICTURE				
CURRENT RATING	3/8(6)/10A	3/8(6)/10A	3/8(6)/10A	3/8(6)/10A





BE Series SWITCH / DUAL-FUSE IEC INLET FILTERS

PRODUCT TYPE	BENG3GM	BEEG3GM	BEEG3FM
PICTURE			
CURRENT RATING	3/6/10A	3/6/10A	2/4/6A

NB Series POWER ENTRY MODULE FILTERS

PRODUCT TYPE	NB3M	NB4M
PICTURE		
CURRENT RATING	3/4/6A	3/4/6A

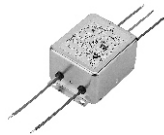
DC Series 2-STAGE HIGH PERFORMANCE FILTERS

PRODUCT TYPE	CG5BM	CW5BM	GG5BM	GW5BM	GS5BM
PICTURE					
CURRENT RATING	3/6/12A	3/6/12A	16A	16A	16A

Medical Filter

EK Series POWER ENTRY MODULE FILTERS

PRODUCT TYPE	EK3M/AM/SM/SAM	EK4M/AM/SM/SAM
PICTURE		
CURRENT RATING	3/6/10A	3/6/10A

DP Series 2-STAGE PERFORMANCE FILTERS

PRODUCT TYPE	CG5CM	CS5CM
PICTURE		
CURRENT RATING	3/6/12/16/20A	16/20A

GS5CM	CG5BM	CW5CM, CW5BM	GG5BM	GW5BM	GS5BM
30A	3/6/12A	3/6/12A	16A	16A	16A

DK Series GENERAL PURPOSE FILTERS

PRODUCT TYPE	BG5BM	CG5BM	CW5BM	CS5BM	BW5BM
PICTURE					
CURRENT RATING	3/6/12A	16/20A	16A	20/30A	3/6/12A

DB Series GENERAL PURPOSE FILTERS

PRODUCT TYPE	BG5BM	BW5BM	CG5BM	CW5BM	CS5BM
PICTURE					
CURRENT RATING	12A	12A	16A	16A	20/30A

MK Series HIGH PERFORMANCE PC BOARD MOUNTING FILTERS

PRODUCT TYPE	MK4EM
PICTURE	
CURRENT RATING	1/3/6/10A

Please feel free to contact us for more detailed specifications or refer to our web site at www.deltaww.com

MEDICAL FILTERS



IEC CONNECTORS SCREW MOUNTING

INTRODUCTIONS

1. Designed to meet globally accepted IEC publication 320 Class 1, that allows users to comply with industry standard in power entry requirement.
2. Connector for cold condition, with pin temperature 70°C max.
3. Nickel-plated brass pins and soldering terminals.
4. Screw-on mount from front or rear (with screw type-M3).
5. Fuse holder designed for one fuse and one spare fuse (both 5x20mm fuses). Safety interlock prevents fuse removal with line plug inserted.
6. Adapts to 110V or 240V input voltage simply by reversing the voltage selector.
7. All part numbers are UL recognized, CSA certified except for SK-015A which is UL listed.
 SK-1000 are DEMKO, approved.
 SK-1017 is UL, CSA approved.
 SK-1008 UL, CSA, VDE, CCC approved.
 SK-1007A UL, CSA approved.
 SK-1007A is patented for new construction (R.O.C. patent no. 54606).
 SK-015A is UL, CSA, VDE, Somko, CCC. Approved

SPECIFICATIONS

1. Rated voltage: 250VAC
2. Minimum insulation resistance at 500VDC: 10M OHM
3. Dielectric strength (one minute): 2000VAC between pins
4. Flammability class: UL 94V-0

ELECTRICAL SCHEMATIC

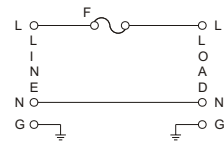

FIG. A

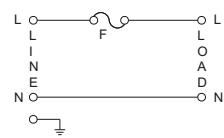
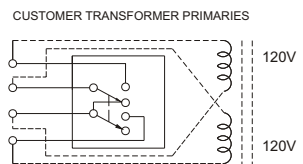

FIG. B



TYPE & RATED CURRENT

DELTA PART NUMBER		SK-015A	SK-1000	SK-1017	SK-1007A	REMARKS: 1. SK-015A RATING SEV/SEMKO/NEMKO/DEMKO-10A/250VAC SK-1017/SK-1000 SEMKO/NEMKO/SETI/DEMKO-10A/250VAC 2. SK-1017 FUSE HOLDER SINGLE FUSE HOLDER ON SK-1017 IS A RETAINED DESIGN 3. VOLTAGE SELECTOR CARD RATING UL/CSA/VDE-10A/250VAC 4. "S" FOR SINGLE FUSE HOLDER
RATED CURRENT (AT 250VAC)	UL/CSA	15A	15A	15A	10A	
	VDE	10A	10A	10A	10A	
CONNECTOR TYPE	MALE	△	△	△	△	
	FEMALE					
FUSE HOLDER		-	S *4	S *2	S *4	
VOLTAGE SELECTOR		-	-	-	FRONT *3	
ELECTRICAL SCHEMATIC		-	FIG. A	FIG. A	FIG. B	
UL		✓	✓	✓	✓	
CSA		✓	✓	✓	✓	
VDE		✓				
SEMKO		✓		✓		
CCC		✓		✓	✓	

MECHANICAL CONSTRUCTION



SK-015A

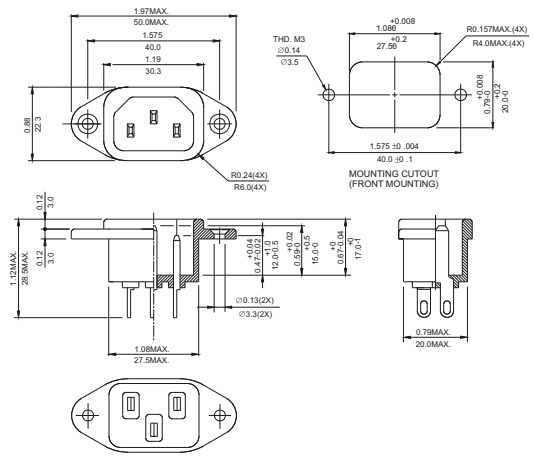

UNIT: INCH/mm

POWER ENTRY MODULES

MECHANICAL CONSTRUCTION



SK-1000

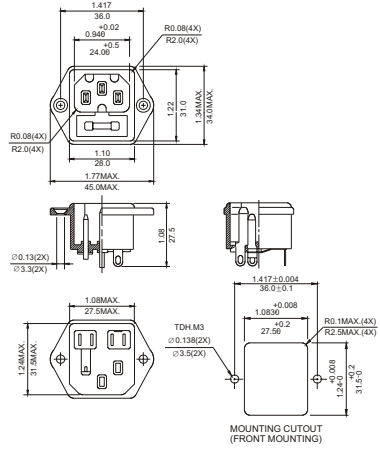

SK-1017

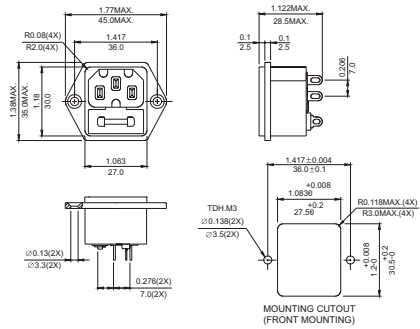

SK-1007A

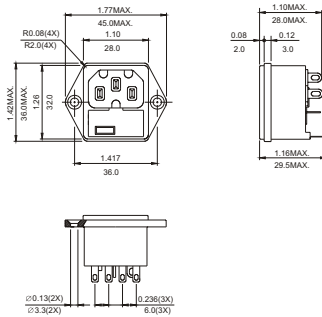

UNIT: $\frac{\text{INCH}}{\text{mm}}$

IEC CONNECTORS SNAP-IN MOUNTING

INTRODUCTIONS

1. Designed to meet globally accepted IEC publication 320 Class 1, that allows users to comply with industry standard in power entry requirement.
2. Connector for cold condition, with pin temperature 70°C max.
3. Nickel-plated brass pins and soldering terminals.
4. SK-1015-STD solder lug mount panel thickness: 1.0mm / 0.04 inch.
SK-1015 (F1.0) fast-on lug mount panel thickness: 1.0mm / 0.04 inch.
SK-1015 (F1.3) fast-on lug mount panel thickness: 1.3mm / 0.05 inch.
SK-1015 (F1.5) fast-on lug mount panel thickness: 1.5mm / 0.06 inch.
SK-1016 panel thickness: 1.0mm / 0.04 inch.
5. Adapts to 115V or 250V input voltage with voltage selector switch.
SK-1015 is UL recognized, CSA certified, VDE approved, SEMKO & CCC approved.
SK-1016: UL recognized, CSA certified, VDE approved, CCC approved.

SPECIFICATIONS

1. Rated voltage: 250VAC
2. Minimum insulation resistance at 500VDC: 10M OHM
3. Dielectric strength (one minute): 2000VAC between pins
4. Flammability class: UL 94V-0

TYPE & RATED CURRENT

DELTA PART NUMBER		SK-1015	SK-1016	REMARKS: 1. SK-1015 RATING SEMKO/NEMKO/DEMKO/SETI-10A/250VAC 2. VOLTAGE SELECTOR SWITCH RATING UL/CSA/VDE/SEMKO/NEMKO/DEMKO/SETI-10A/250VAC
RATED CURRENT (AT 250VAC)	UL/CSA	15A	15A	
	VDE	10A	10A	
CONNECTOR TYPE	MALE	△		
	FEMALE		△	
UL		✓	✓	
CSA		✓	✓	
VDE		✓	✓	
SEMKO		✓		
CCC		✓	✓	

MECHANICAL CONSTRUCTION



SK-1015

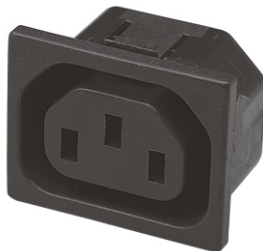

SK-1016

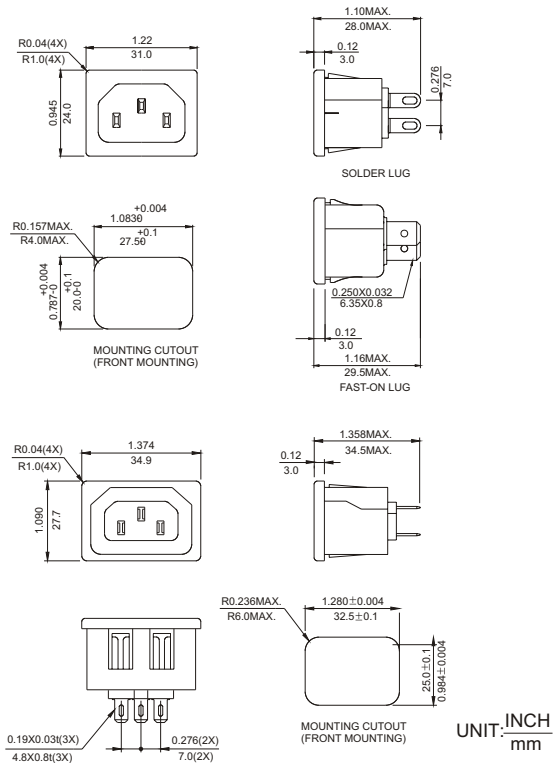



IEC CONNECTORS PC BOARD AND SCREW MOUNTING

INTRODUCTIONS

1. Designed to meet globally accepted IEC publication 320 Class 1, that allows users to comply with industry standard in power entry requirement.
2. Connector for cold condition, with pin temperature 70°C max.
3. Nickel-plated brass pins for soldering on PC board.
4. SK-1010: UL, CSA, VDE, CCC approved.
SK-1019: UL, CSA, VDE, CCC approved.
SK-1013: UL, CSA approved.

SPECIFICATIONS

1. Rated voltage: 250VAC
2. Minimum insulation resistance at 500VDC: 10M OHM
3. Dielectric strength (one minute): 2000VAC between pins
4. Flammability class: UL 94V-0

DELTA PART NUMBER		SK-1010, SK-1019	SK-1013
RATED CURRENT (AT 250VAC)	UL/CSA	15A	*10A/15A
	VDE	10A	-
	NORDIC	10A	-
CONNECTOR TYPE	MALE	△	△
	FEMALE		△

MECHANICAL CONSTRUCTION



SK-1010

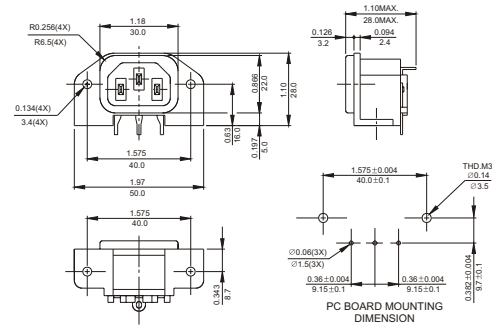

SK-1013

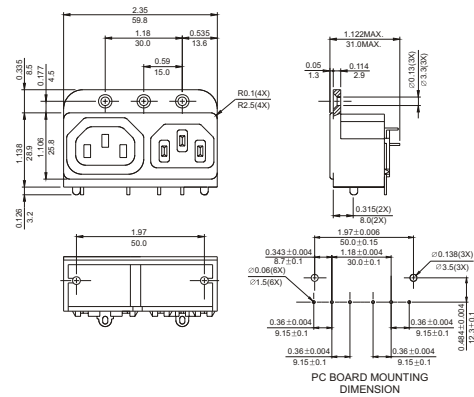

SK-1019

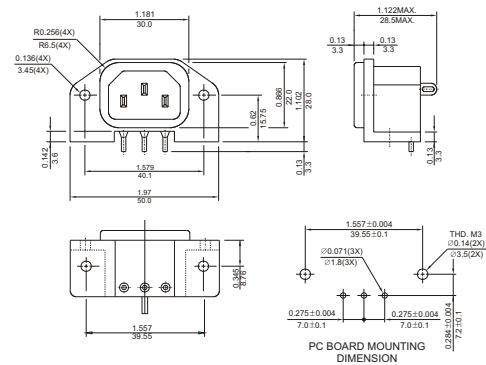

UNIT: INCH
mm

POWER ENTRY MODULES

POWER ENTRY MODULES **SNAP-IN MOUNTING**

INTRODUCTIONS

1. Designed to meet globally accepted IEC publication 320 Class 1, that allows users to comply with industry standard in power entry requirement.
2. Connector for cold condition, with pin temperature 70°C max.
3. Nickel-plated brass pins and soldering terminals.
4. Snap-in mount (panel thickness: 0.04 inch to 0.07 inch).
5. Power module in plastic or metal case that incorporates an IEC connector, fuse holder, power switch and voltage selector switch, all-in-one easy-to-install unit.
Part numbers 06A1, 06A2, 06A2D and 06A5 are power modules in plastic case; part numbers 06AN2, 06AN2D, 06AN3, 06AN3D and 06AN5 are power modules in metal case.
6. Fuse holder designed for one fuse. Safety interlock prevents fuse removal with line plug inserted.
7. Adapts to 110V or 220V input voltage with voltage selector switch.
8. Compact design and high volume production provide maximum flexibility and significant savings in space and cost over assembly of individual components.
9. All part numbers are UL recognized, CSA certified and SEMKO approved.

SPECIFICATIONS

1. Rated voltage: 115VAC/250VAC
2. Maximum leakage current each line-to-ground
2uA AT 115VAC/60Hz
5uA AT 250VAC/50Hz
3. Dielectric strength (one minute)
line-to-ground: 2250VDC
line-to-line: 1450VDC
4. Flammability class: UL 94V-0

ELECTRICAL SCHEMATIC

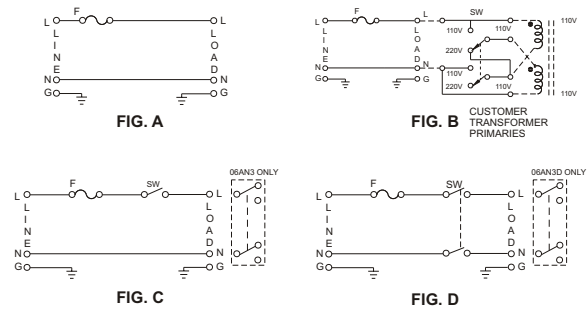

TYPE & RATED CURRENT

DELTA PART NUMBER		06A1	06A2	06A2D	06A5	REMARKS: * 1. SINGLE-POLE POWER SWITCH UL/CSA APPROVED AT 6A, 125VAC/250VAC VDE APPROVED AT 6A/250VAC ELECTRICAL LIFETIME: 50,000 CYCLES MAXIMUM IN-RUSH CURRENT: 70A * 2. DOUBLE-POLE POWER SWITCH ELECTRICAL LIFETIME: 10,000 CYCLES MAXIMUM IN-RUSH CURRENT: 50A * 3. VOLTAGE SELECTOR SWITCH UL/CSA APPROVED AT 6A/125VAC & 250VAC VDE APPROVED AT 6A/250VAC
RATED CURRENT	UL/CSA (115VAC/250VAC)	6A	6A	4A	6A	
	SEMKO					
CONNECTOR TYPE	MALE	△	△	△	△	
	FEMALE					
FUSE HOLDER		S	S	S	S	
POWER SWITCH		-	SP *1	DP *2	-	
VOLTAGE SELECTOR		-	-	-	FRONT *3	
ELECTRICAL SCHEMATIC		FIG. A	FIG. C	FIG. D	FIG. B	

DELTA PART NUMBER		06AN2	06AN2D	06AN3	06AN3D	06AN5	REMARKS: * 1. SINGLE-POLE POWER SWITCH UL/CSA APPROVED AT 6A, 125VAC/250VAC VDE APPROVED AT 6A/250VAC ELECTRICAL LIFETIME: 50,000 CYCLES MAXIMUM IN-RUSH CURRENT: 70A * 2. DOUBLE-POLE POWER SWITCH ELECTRICAL LIFETIME: 10,000 CYCLES MAXIMUM IN-RUSH CURRENT: 50A * 3. VOLTAGE SELECTOR SWITCH (FRONT) UL/CSA APPROVED AT 6A, 125VAC/250VAC VDE APPROVED AT 6A/250VAC * 4. VOLTAGE SELECTOR SWITCH (REAR) UL/CSA/VDE APPROVED AT 10A/125VAC & 5A/250VAC
RATED CURRENT	UL/CSA (115VAC/250VAC)	6A	6A			6A	
	SEMKO		4A				
CONNECTOR TYPE	MALE	△	△	△	△	△	
	FEMALE						
FUSE HOLDER		S	S	S	S	S	
POWER SWITCH		SP*1	DP *2	SP *1	DP *2	-	
VOLTAGE SELECTOR		-	-	REAR*4	REAR*4	FRONT *3	
ELECTRICAL SCHEMATIC		FIG. C	FIG. D	FIG. C	FIG. D	FIG. B	

MECHANICAL CONSTRUCTION



06A5
06A1 (Without voltage selector switch)

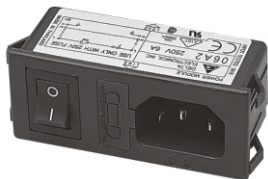
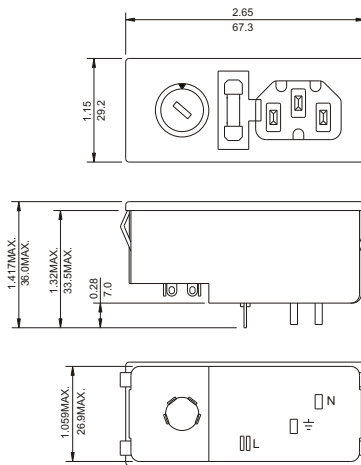

06A2

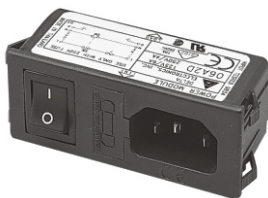
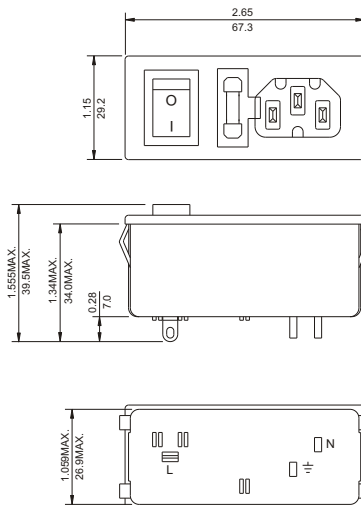

06A2D

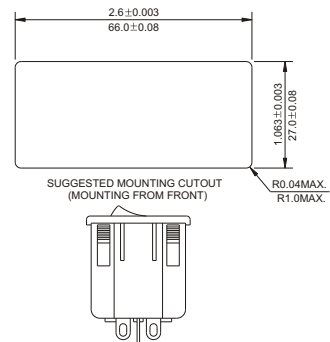
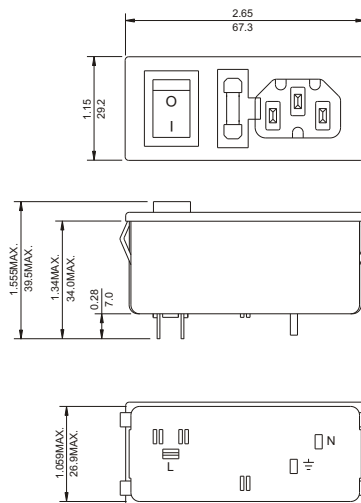

UNIT: $\frac{\text{INCH}}{\text{mm}}$

MECHANICAL CONSTRUCTION

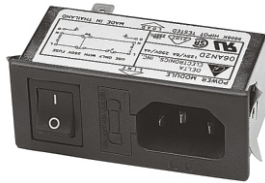

06AN2
06AN2D

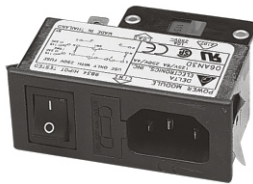
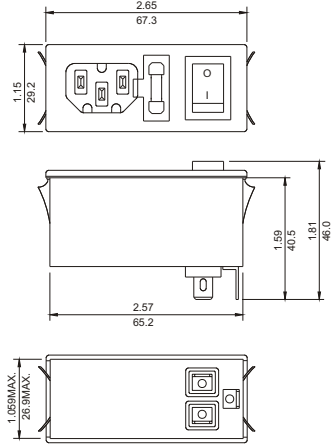

06AN3
06AN3D

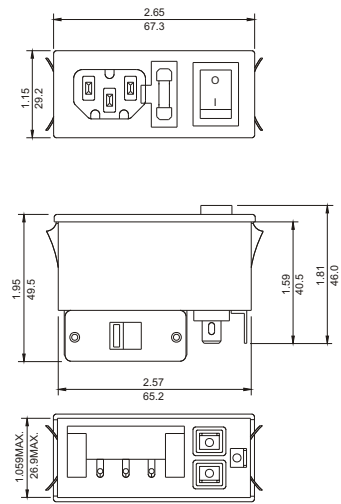

06AN5

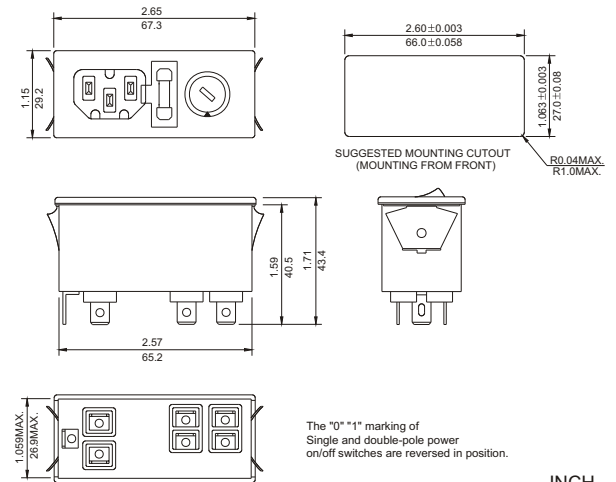

The "0" "1" marking of Single and double-pole power on/off switches are reversed in position.

UNIT: INCH
mm

POWER ENTRY MODULES **SCREW & SNAP-IN MOUNTING**

INTRODUCTIONS

1. Designed to meet globally accepted IEC publication 320 Class 1, that allows users to comply with industry standards in power entry requirement.
2. Connector for cold condition, with pin temperature 70°C max.
3. Nickel-plated brass pins and soldering terminals.
4. Screw-on mount from front or rear (with screw type-M3).
5. Power module incorporates an IEC connector, double fuse holder, voltage selector, double-pole power switch, all-in-one easy-to-install unit.
6. Double-fuse holder designed for two fuses, single fuse & dual fuse capability are both available (all 5x20mm fuses).
7. Adapts to 110-120V or 220-240V input voltage simply by reversing the voltage selector card.
8. Compact design and high volume production provide maximum flexibility and significant savings in space and cost over assembly of individual components.
9. All part numbers are UL, CSA and SEMKO approved.
10. SK-1027/SK-1028 with a variety of built-in filter are also available, see Delta EMI filter catalog for SB/NB series.

SPECIFICATIONS

1. Rated voltage: 250VAC
2. Minimum insulation resistance at 500VDC: 10M OHM
3. Dielectric strength (one minute): 2000VAC between pins
4. Flammability class: UL 94V-0

ELECTRICAL SCHEMATIC

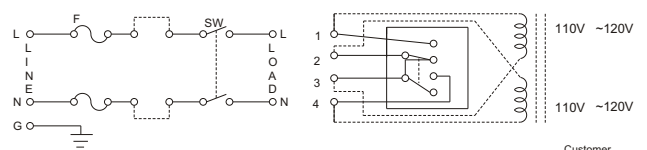

FIG. A

Customer transformer primaries

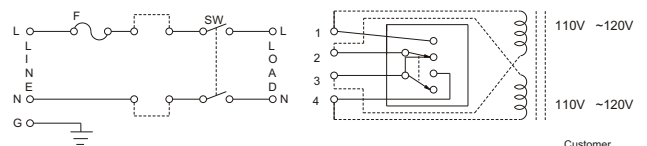

FIG. B

Customer transformer primaries

TYPE & RATED CURRENT

DELTA PARTNUMBER		SK-1027		SK-1028		REMARKS: *1. DOUBLE-POLE POWER SWITCH UL, CSA AND VDE APPROVED AT 10A/250VAC ELECTRICAL LIFETIME: 10,000 CYCLE MAXIMUM IN-RUSH CURRENT: 51A *2. VOLTAGE SELECTOR CARD RATING UL/CSA-10A/250VAC VDE-6A/250VAC
RATED CURRENT (AT 250VAC)	UL/CSA	10A	10A	10A	10A	
	SEMKO	6A	6A	6A	6A	
CONNECTOR TYPE	MALE	△	△	△	△	
	FEMALE					
FUSE HOLDER		S	D	S	D	
POWER SWITCH	*	DP*1	DP*1	DP*1	DP*1	
VOLTAGE SELECTOR	*	FRONT*2	FRONT*2	FRONT*2	FRONT*2	
ELECTRICAL SCHEMATIC		FIG. B	FIG. A	FIG. A	FIG. B	
MOUNTING TYPE		SCREW		SNAP-IN		

MECHANICAL CONSTRUCTION

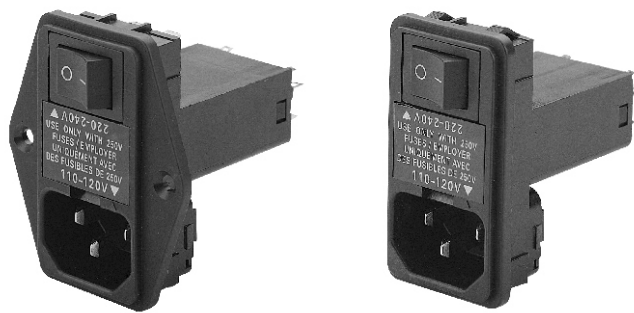

SK1027

SK1028

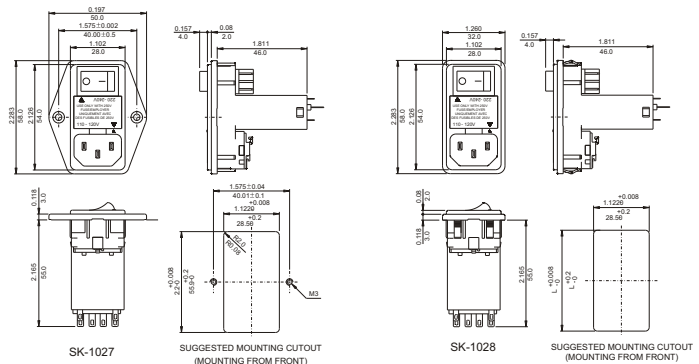

SK-1027

SUGGESTED MOUNTING CUTOUT (MOUNTING FROM FRONT)

SK-1028

SUGGESTED MOUNTING CUTOUT (MOUNTING FROM FRONT)

L according to panel thickness:
0.032~0.071INCH L=2,200(0.8~2.0mm) L=55.9
0.08~0.128INCH L=2,213(2.1~3.2mm) L=56.2

UNIT: $\frac{\text{INCH}}{\text{mm}}$



TD SERIES

3-PHASE, 3-WIRE FILTERS

COMPONENTS

PART NO.	Cx (uF)	Cy (pF)	L1 (uH)	L2 (mH)	R (KΩ)
10TDS6D	0.22	2200	122	2.8	500
20TDS6D			78	1.6	
30TDS6D			40	0.9	
40TDS6D			32	1.1	
50TDS6D			14	0.6	

INTRODUCTIONS

1. Applications: Electric equipment, UPS, machine tool, copy machine, automation equipment, robot, AC motor drive
2. Voltage rating: 440VAC
3. Operating frequency: 50/60Hz

MINIMUM INSERTION LOSS IN dB

COMMON MODE (L-G) IN 50 OHM SYSTEM							
TYPE	CURRENT RATING	FREQUENCY - MHz					
		.15	.50	1.0	5.0	10	30
10TDS6D	10A	25	35	40	40	40	25
20TDS6D	20A	15	30	30	35	25	20
30TDS6D	30A	15	20	30	40	40	25
40TDS6D	40A	20	30	30	35	40	30
50TDS6D	50A	10	20	20	35	35	35
DIFFERENTIAL MODE (L-L) IN 50 OHM SYSTEM							
10TDS6D	10A	15	35	45	45	45	30
20TDS6D	20A	10	30	40	40	30	20
30TDS6D	30A	10	20	30	40	30	20
40TDS6D	40A	10	20	30	35	40	35
50TDS6D	50A	8	20	30	35	35	35

ELECTRICAL SCHEMATIC

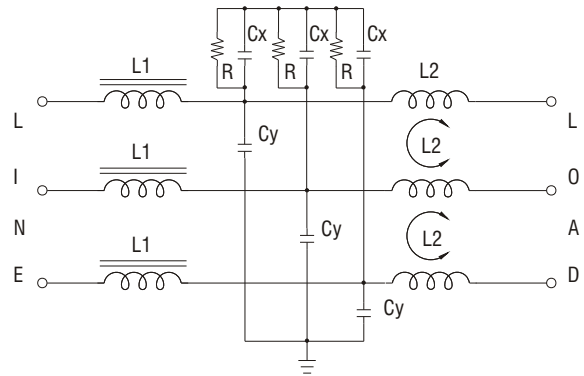

SERIES DIMENSIONS

DIM. TYPE	A	B	C	D	E	F	G	H	I	J
10TDS6D	7.16	6.692	2.36	6.69	4.80	5.314	5.98	1.37	2.63	M6X1.0
	182.0	170.0	60.0	170.0	122.0	135.0	152.0	35.0	67.0	
20TDS6D	7.16	6.692	2.36	6.69	4.80	5.314	5.98	1.37	2.63	
30TDS6D	182.0	170.0	60.0	175.0	122.0	135.0	152.0	35.0	67.0	
40TDS6D	7.16	6.299	1.96	10.23	7.95	8.661	9.52	1.57	3.22	
50TDS6D	182.0	160.0	50.0	260.0	202.0	220.0	242.0	40.0	82.0	

MECHANICAL CONSTRUCTION

Terminal cover: (Optional)

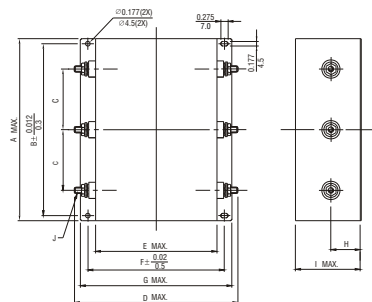
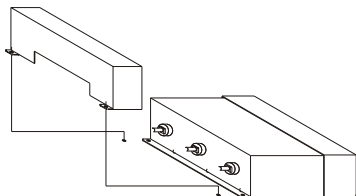
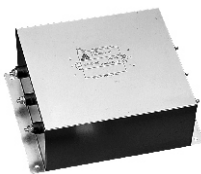

THREE-PHASE FILTERS

UNIT: INCH
mm



TDH SERIES

LOW VOLTAGE 3-PHASE, 3-WIRE FILTERS

COMPONENT

PART NO.	L (mH)	Cx (uF)	Cy (pF)	R (KΩ)
10TDHG6	2.3	0.22	4700	680
20TDHG6	0.5			
30TDHS6	0.5			
40TDHS6	1.1	0.47		
50TDHS6	0.7	0.68		

MINIMUM INSERTION LOSS IN dB

COMMON MODE (L-G) IN 50 OHM SYSTEM							
TYPE	CURRENT RATING	FREQUENCY - MHz					
		.15	.50	1.0	5.0	10	30
10TDHG6	10A	25	40	40	40	40	35
20TDHG6	20A	15	25	28	38	45	35
30TDHS6	30A	10	25	25	35	30	20
40TDHS6	40A	18	30	30	35	40	25
50TDHS6	50A	15	28	28	35	40	35

DIFFERENTIAL MODE (L-L) IN 50 OHM SYSTEM							
TYPE	CURRENT RATING	FREQUENCY - MHz					
		.15	.50	1.0	5.0	10	30
10TDHG6	10A	15	28	40	40	45	40
20TDHG6	20A	15	25	28	50	55	40
30TDHS6	30A	15	25	35	35	35	40
40TDHS6	40A	18	28	35	45	50	35
50TDHS6	50A	20	30	35	40	45	45

INTRODUCTIONS

1. Applications: Electric equipment, UPS, machine tool, copy machine, automation equipment, robot, AC motor drive
2. Voltage rating: 250VAC
3. Operating frequency: 50/60Hz

ELECTRICAL SCHEMATIC

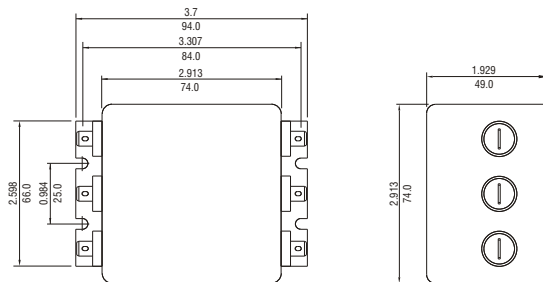
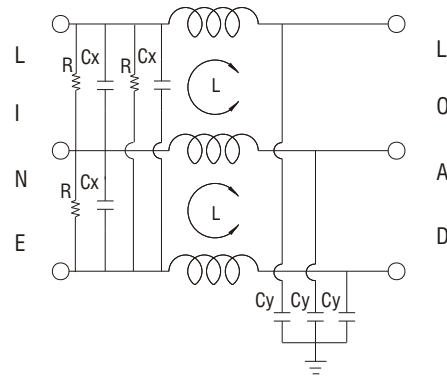

10/20TDHG6

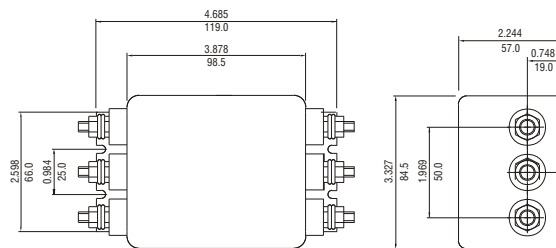

30TDHS6

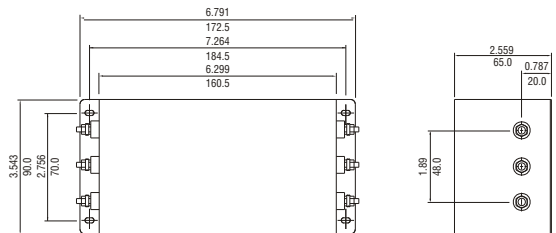

40/50TDHS6

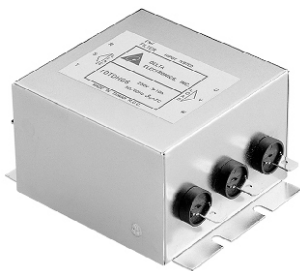

10/20TDHG6

UNIT: INCH
mm

THREE-PHASE FILTERS



TDR SERIES

VERTICAL 3-PHASE, 3-WIRE FILTERS

COMPONENTS

PART NO.	ΣC_x (uF)	ΣC_y (uF)	ΣL (mH)	R1 (M Ω)	R2 (M Ω)
07TDRT1W4	4	1.5	4.5	1.5	0.68
16TDRT1W4	5.9		3.0		
30TDRT1W4	6.6	2.2	2.0		
42TDRT1W4		2.3	1.5		
55TDRT1W4			1.1		

INTRODUCTIONS

1. Applications: Electric equipment, UPS, machine tool, copy machine, automation equipment, robot, AC motor drive
2. Voltage rating: 480VAC
3. Operating frequency: 50/60Hz

MINIMUM INSERTION LOSS IN dB

COMMON MODE (L-G) IN 50 OHM SYSTEM						
PART NO.	FREQUENCY-MHz					
	.15	.50	1.0	5.0	10	30
07TDRT1W4	25	60	60	60	55	35
16TDRT1W4	20	60	60	60	55	35
30TDRT1W4	20	55	55	55	50	35
42TDRT1W4	20	55	55	55	50	35
55TDRT1W4	20	55	55	55	50	35
DIFFERENTIAL MODE (L-L) IN 50 OHM SYSTEM						
07TDRT1W4	35	65	65	65	60	40
16TDRT1W4	35	65	65	65	60	40
30TDRT1W4	35	65	65	65	60	40
42TDRT1W4	30	60	60	60	50	40
55TDRT1W4	30	60	60	60	50	40

ELECTRICAL SCHEMATIC

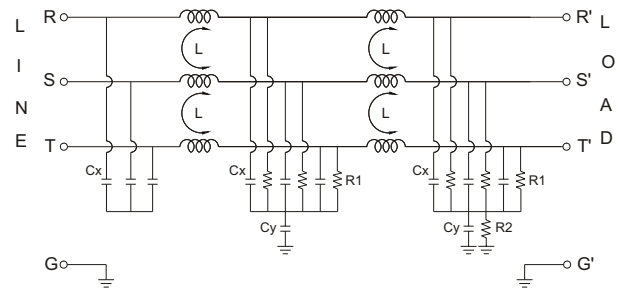

SERIES DIMENSIONS

PART NO.	DIMENSIONS IN INCHES/mm							G
	A	B	C	D	E	F		
07TDRT1W4	8.937	2.047	5.039	10.118	9.449	0.984	11.811	AWG18
	227.0	52.0	128.0	257.0	240.0	25.0		
16TDRT1W4	10.906	2.244	5.669	12.087	11.417	1.181	300.0	AWG14
	227.0	57.0	144.0	307.0	290.0	30.0		
30TDRT1W4	12.087	2.440	5.984	13.268	12.598	1.378	15.748	AWG12
	307.0	62.0	152.0	337.0	320.0	35.0		
42TDRT1W4	11.890	2.835	7.362	13.031	12.362	1.772	19.685	AWG10
	302.0	72.0	187.0	331.0	314.0	45.0		
55TDRT1W4	302.0	3.228	187.0	331.0	314.0	2.165	500.0	AWG10
		82.0				55.0		

MECHANICAL CONSTRUCTION

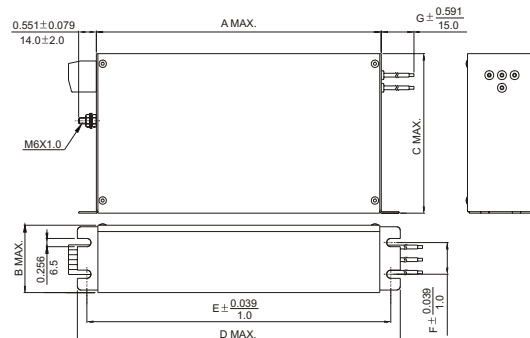
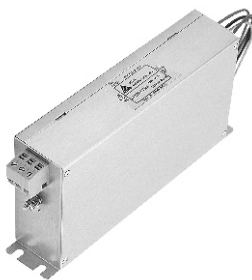

UNIT: INCH
mm



TDR SERIES

VERTICAL 3-PHASE, 3-WIRE FILTERS

COMPONENTS

PART Number	Cx(uF)	Cy(uF)	L(mH)	L1(uH)	R(MΩ)
10TDRT2	1.0	0.47	2.8	-	1.0
18TDRT2		0.68	2.9		
25TDRT2		1.0	1.9		
36TDRT2	1.0	0.47	0.396	7.0	
50TDRT2	2.2	1.0	0.275	5.1	

INTRODUCTIONS

1. Applications: Electric equipment, UPS, machine tool, copy machine, automation equipment, robot, AC motor drive
2. Voltage rating: 500VAC
3. Operating frequency: 50/60Hz

ELECTRICAL SCHEMATIC

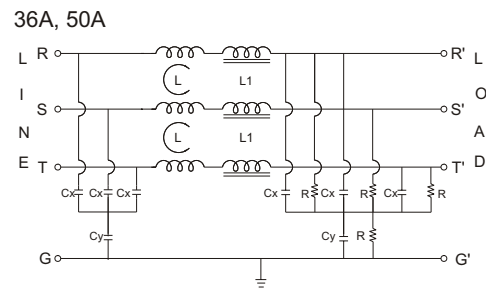
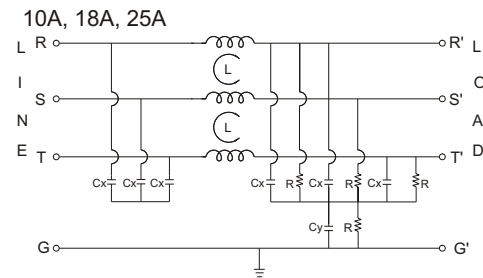

MINIMUM INSERTION LOSS IN dB

PART NO.	COMMON MODE (L-G) IN 50 OHM SYSTEM								
	FREQUENCY-MHz								
	.01	.05	.10	.15	.50	1.0	5.0	10	30
10TDRT2	5	25	40	45	55	50	40	30	30
18TDRT2	10	30	40	50	50	50	40	35	20
25TDRT2	10	30	45	55	45	45	40	30	20
36TDRT2	5	25	45	55	50	45	40	35	35
50TDRT2	5	35	55	55	50	45	40	40	30

PART NO.	DIFFERENTIAL MODE (L-L) IN 50 OHM SYSTEM								
	FREQUENCY-MHz								
	.01	.05	.10	.15	.50	1.0	5.0	10	30
10TDRT2	5	15	10	30	55	50	40	30	30
18TDRT2	5	12	25	35	50	50	50	40	25
25TDRT2	10	10	40	45	45	45	40	35	25
36TDRT2	5	10	20	30	50	45	40	40	40
50TDRT2	5	10	35	45	50	45	40	40	30

SERIES DIMENSIONS

PART NO.	DIMENSIONS IN INCHES/mm										
	A	B	C	D	E	F	G	H	I	J	K
10TDRT2	6.024	1.772	3.189	7.087	7.756	6.575	1.260	0.591	0.236 x 0.315	0.236	M5x0.8
	153.0	45.0	81.0	180.0	197.0	167.0	32.0				
18TDRT2	7.992	2.205	4.567	9.016	9.724	8.622	1.655	15.0	6.0 x 8.0	Ø6.0	M5x0.8
	203.0	56.0	116.0	229.0	247.0	219.0	42.0				
25TDRT2	9.528	2.953	6.417	10.709	11.496	10.236	2.362	0.787	0.276 x 0.394	0.276	M6x1.0
	242.0	75.0	163.0	272.0	292.0	260.0	60.0				
36TDRT2	9.528	2.953	6.417	10.709	11.496	10.236	2.362	0.787	0.276 x 0.394	0.276	M6x1.0
	242.0	75.0	163.0	272.0	292.0	260.0	60.0				
50TDRT2	9.528	2.953	6.417	10.709	11.496	10.236	2.362	0.787	0.276 x 0.394	0.276	M6x1.0
	242.0	75.0	163.0	272.0	292.0	260.0	60.0				

MECHANICAL CONSTRUCTION

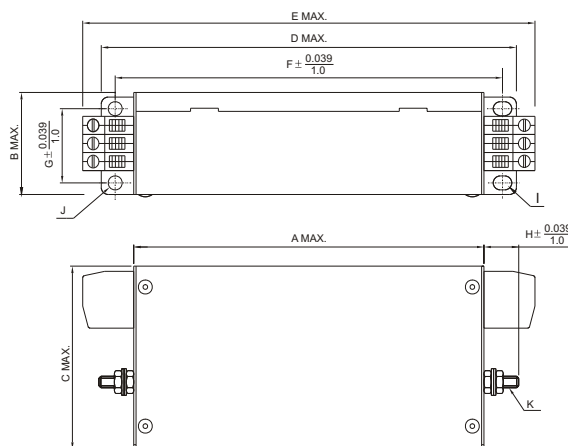
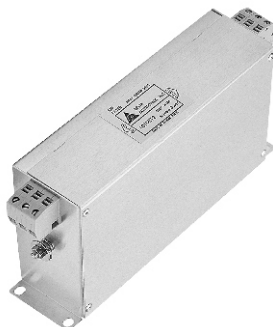

UNIT: INCH/mm

THREE-PHASE FILTERS



TDS SERIES

GENERAL 3-PHASE, 3-WIRE FILTERS

COMPONENTS

PART NO.	Leakage current max mA	L (mH)	L1 (mH)	Cx (uF)	Cy (nF)	R (KΩ)
• 08TDS4W4	6.5	4.2	1.5	1	15	470
• 24TDS4W4		1	0.5			
PART NO.	Leakage current max mA	L (mH)	Σ Cx (uF)	Σ Cy (uF)	R1 (MΩ)	R2 (MΩ)
08TDS8	14.5	7.6	1.6	0.17	2	-
16TDS8		5.2	3.4			
36TDS8	160	1.3	4.4	1.8	1.5	1.1

• UL, VDE approved

INTRODUCTIONS

1. Applications: Electric equipment, UPS, machine tool, copy machine, automation equipment, robot, AC motor drive
2. Voltage rating: 480VAC
3. Operating frequency: 50/60Hz

ELECTRICAL SCHEMATIC

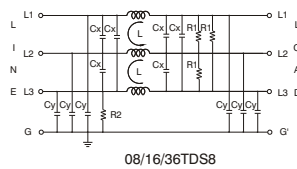
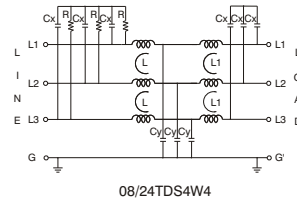

MINIMUM INSERTION LOSS IN dB

COMMON MODE (L-G) IN 50 OHM SYSTEM							
TYPE	CURRENT RATING	FREQUENCY – MHz					
		.15	.50	1.0	5.0	10	30
08TDS4W4	8A	70	65	60	50	40	30
24TDS4W4	24A	40	65	70	70	60	35
08TDS8	8A	50	65	65	55	50	50
16TDS8	16A	45	70	65	55	50	50
36TDS8	36A	60	70	65	55	50	55
DIFFERENTIAL MODE (L-L) IN 50 OHM SYSTEM							
08TDS4W4	8A	35	65	70	55	50	35
24TDS4W4	24A	15	60	65	65	60	40
08TDS8	8A	50	65	60	55	50	50
16TDS8	16A	50	70	65	55	55	50
36TDS8	36A	50	70	65	55	50	45

SERIES DIMENSIONS

	08TDS4W4	24TDS4W4	08TDS8	16TDS8	36TDS8
A	145	180			200
B	135		115		
C	75	115			150
D	55	100			136
E	45	60			65
F	16		18		
H			6.4		
I		85		120	
J	M4 X 0.7		M6 X 1.0		
K	15		20		
L	300				
M	6				
N	7 X 5.3				
T			0.8		
W	AWG18	AWG16			

MECHANICAL CONSTRUCTION

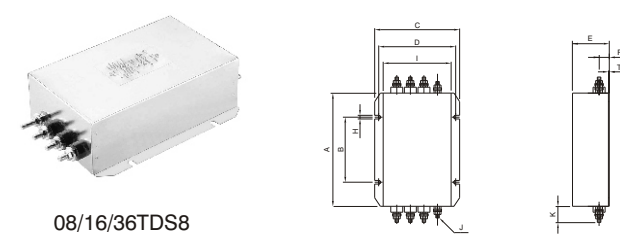
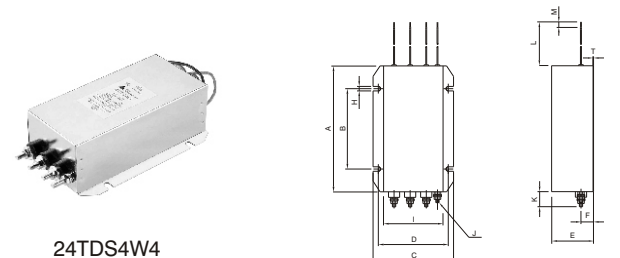
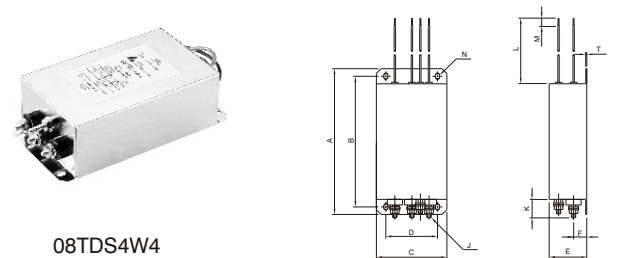

THREE-PHASE FILTERS

MECHANICAL CONSTRUCTION



08TDS4W4

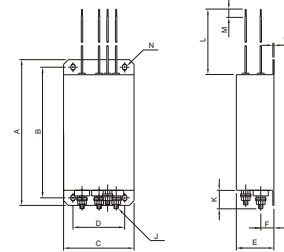

24TDS4W4

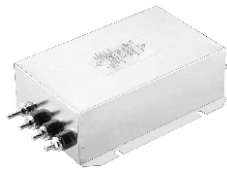
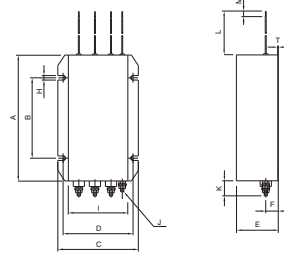

08/16/36TDS8

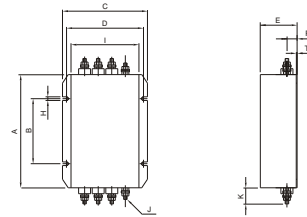

100TDS6

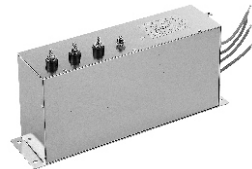
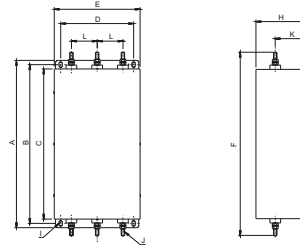

50TDS4W4

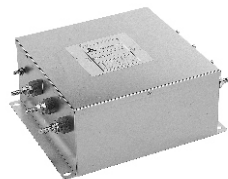
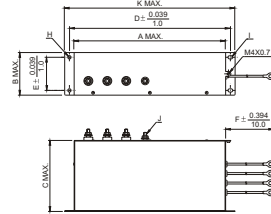

100TDS8A

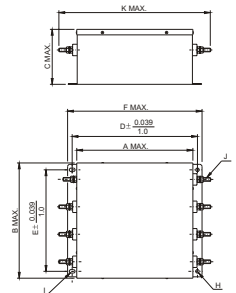

UNIT: INCH
mm



TDS SERIES

HIGH CURRENT 3-PHASE, 3-WIRE FILTERS

COMPONENTS

PART NO.	Cx(uF)	Cy(uF)	L(uH)	R1(uH)	R2(KΩ)
200TDSS84	4.7	2.2	90	470	1.0
300TDSS84	10.0		3.0		
400TDSS84	12.2		3.0		
500TDSS84	14.7	4.7	3.0		
600TDSS84	20.0				

MINIMUM INSERTION LOSS IN dB

COMMON MODE (L-G) IN 50 OHM SYSTEM									
PART NO.	FREQUENCY-MHz								
	.01	.05	.10	.15	.50	1.0	5.0	10	30
200TDSS84	5	20	30	35	50	45	25	20	10
300TDSS84	5	20	25	30	30	23	10	8	5
400TDSS84	5	20	28	30	30	20	10	5	2
500TDSS84	10	25	35	45	25	20	10	5	2
600TDSS84	5	10	25	25	25	20	10	5	2

DIFFERENTIAL MODE (L-L) IN 50 OHM SYSTEM									
PART NO.	FREQUENCY-MHz								
	.01	.05	.10	.15	.50	1.0	5.0	10	30
200TDSS84	20	30	40	40	50	45	25	20	15
300TDSS84	25	35	35	35	30	25	14	10	5
400TDSS84	20	35	30	30	30	20	10	8	2
500TDSS84	15	35	40	40	30	25	10	10	5
600TDSS84	15	20	40	40	30	25	10	10	5

SERIES DIMENSIONS

PART NO.	DIMENSIONS IN INCHES/mm												
	A	B	C	D	E	F	G	H	I	J	K	L	M
200TDSS84	17.008 432.0	14.960 380.0	13.071 332.0	8.346 212.0	4.528 115.0	13.976 355.0	7.087 180.0	0.315x0.551 8.0X14.0	0.118 3.0	0.315 8.0	Ø0.472 Ø12.0	1.024 26.0	-
300TDSS84	20.669	18.800	15.827	9.528	5.591	17.717	2.362	2.765	0.256x0.315	0.118	Ø0.236	0.591	1.772
400TDSS84	525.0	477.0	402.0	242.0	142.0	450.0	60.0	70.0	6.5X8.0	3.0	Ø6.0	15.0	45.0
500TDSS84	26.772	22.520	19.764	10.709	7.165	21.457	2.953	2.953	0.295x0.374	0.236	Ø0.295	0.591	2.165
600TDSS84	680.0	572.0	502.0	272.0	182.0	545.0	75.0	75.0	7.5X9.5	6.0	Ø7.5	15.0	55.0

MECHANICAL CONSTRUCTION

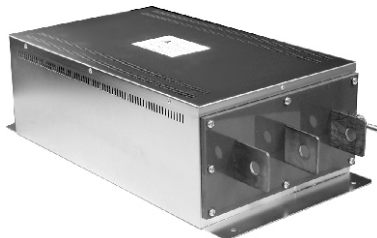

INTRODUCTIONS

1. Applications: Electric equipment, UPS, machine tool, copy machine, automation equipment, robot, AC motor drive
2. Voltage rating: 480VAC
3. Operating frequency: 50/60Hz

ELECTRICAL SCHEMATIC

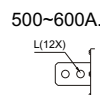
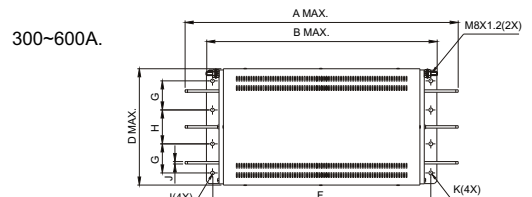
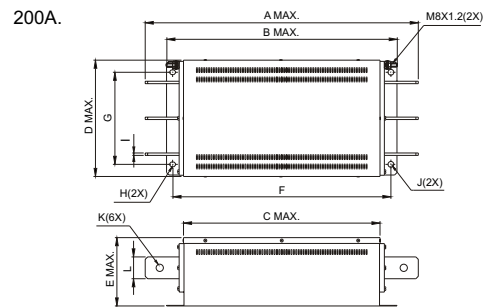
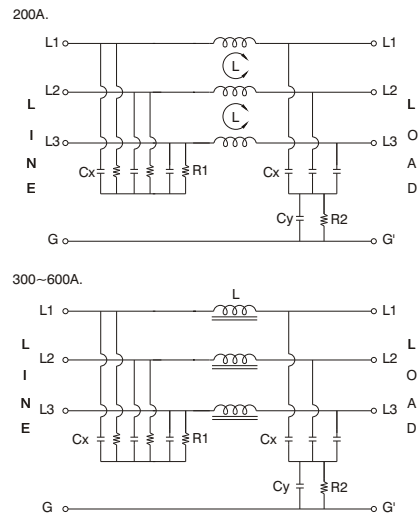

UNIT: INCH/mm



TDT SERIES

HIGH PERFORMANCE 3-PHASE, 3-WIRE FILTERS

COMPONENTS

PART NO.	ΣCx (uF)	ΣCy (uF)	L (mH)	R (M Ω)	R1 (M Ω)
08TDT2	1.6	0.17	7.6	2.0	-
16TDT2	3.4		5.2	1.5	1.1
25TDT2	4.4	2.2			
36TDT2		1.3			
50TDT2	2.0	0.8			

INTRODUCTIONS

1. Applications: Electric equipment, UPS, machine tool, copy machine, automation equipment, robot, AC motor drive
2. Voltage rating: 480VAC
3. Operating frequency: 50/60Hz

MINIMUM INSERTION LOSS IN dB

PART NO.	COMMON MODE (L-G) IN 50 OHM SYSTEM							
	FREQUENCY-MHz							
	.01	.05	.15	.50	1.0	5.0	10	30
08TDT2	20	30	40	50	65	65	55	50
16TDT2	15	25	35	45	70	65	55	50
25TDT2	15	25	35	40	50	50	50	40
36TDT2	10	35	50	50	60	60	50	40
50TDT2	5	30	50	50	50	50	50	50
PART NO.	DIFFERENTIAL MODE (L-L) IN 50 OHM SYSTEM							
	.01	.05	.15	.50	1.0	5.0	10	30
08TDT2	10	10	20	50	65	65	55	50
16TDT2	10	10	40	50	70	65	55	50
25TDT2	10	10	40	45	50	50	50	40
36TDT2	10	20	40	50	60	60	50	45
50TDT2	5	20	40	45	50	50	50	50

ELECTRICAL SCHEMATIC

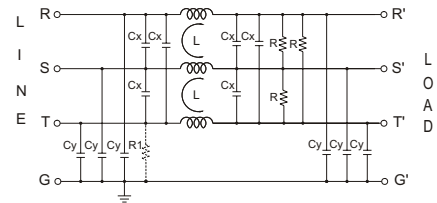

SERIES DIMENSIONS

PART NO.	DIMENSIONS IN INCHES/mm							
	A	B	C	D	E	F	G	H
08TDT2	7.165 182.0	3.425 87.0	2.40 61.0	4.606 117.0	4.528 115.0	3.937 100.0	8.898 226.0	—
16TDT2	7.953 202.0	4.803 122.0	2.598 66.0	5.984 152.0		5.354 136.0	9.646 245.0	
25TDT2					9.882 251.0			
36TDT2								
50TDT2								

MECHANICAL CONSTRUCTION

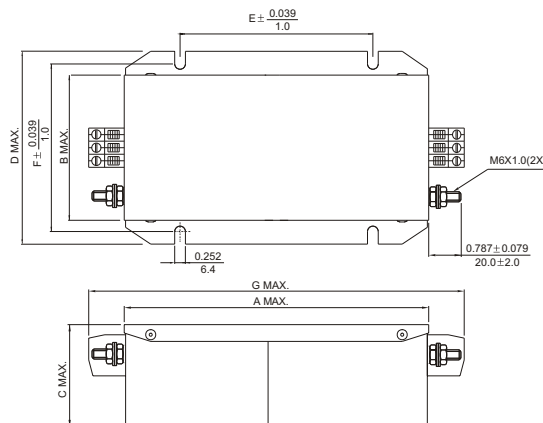
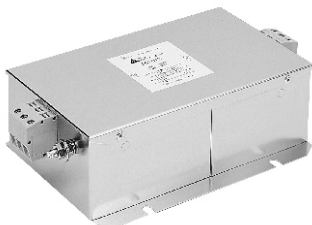



TDV SERIES

3-PHASE FILTERS



COMPONENTS

PART NO.	Cx1(uF)	Cx2(uF)	Cy(uF)	L(mH)	R1(MΩ)	R2(MΩ)
07TDVST2	4.4	2.2	2.2	2.52	1.0	0.68
16TDVST2				1.70		
30TDVST2				1.00		
42TDVST2	4.4	4.4	2.2	0.60	1.0	0.68
55TDVST2				0.60		
75TDVST2	6.6	6.6	2.2	0.45	1.5	0.68
100TDVST2				0.30		

MINIMUM INSERTION LOSS IN dB

COMMON MODE(L-G)IN 50 OHM SYSTEM							
PART NO.	FREQUENCY-MHz						
	.15	.50	1.0	5.0	10	30	
07TDVST2	50	70	65	50	40	20	
16TDVST2	50	50	50	45	30	20	
30TDVST2	50	55	50	45	30	15	
42TDVST2	45	50	50	30	25	10	
55TDVST2	45	60	55	35	30	10	
75TDVST2	40	55	50	25	18	7	
100TDVST2	35	50	45	25	15	7	

DIFFERENTIAL MODE(L-L)IN 50 OHM SYSTEM							
PART NO.	FREQUENCY-MHz						
	.15	.50	1.0	5.0	10	30	
07TDVST2	45	60	70	50	40	40	
16TDVST2	45	45	50	40	35	30	
30TDVST2	45	45	45	45	45	25	
42TDVST2	35	50	50	40	40	20	
55TDVST2	40	55	55	50	50	20	
75TDVST2	40	45	45	40	40	5	
100TDVST2	30	35	35	35	30	7	

SERIES DIMENSIONS

PART NO.	DIMENSIONS IN INCHES/mm						
	A	B	C	D	E	F	G
07TDVST2	6.378	1.654	2.835	7.559	7.087	0.787	0.213
	162.0	42.0		192.0	180.0	20.0	
16TDVST2	8.740	1.850	72.0	9.921	9.252	0.984	5.4
	222.0	47.0		252.0	235.0	25.0	
30TDVST2	9.528	2.047	3.425	10.709	10.039	1.181	0.213
42TDVST2	242.0			272.0	255.0		
42TDVST2	11.102	52.0	87.0	12.283	11.614	30.0	5.4
55TDVST2	282.0	295.0					
55TDVST2	8.740	3.425	3.622	9.921	9.252	2.362	0.213
75TDVST2	222.0	87.0	92.0	252.0	235.0		
75TDVST2	9.528	3.622	5.394	10.709	10.039	60.0	0.256
100TDVST2	242.0	92.0	137.0	272.0	255.0		
100TDVST2	9.449	3.543	5.906	10.63	10.039	2.559	6.5
	240.0	90.0	150.0	270.0	255.0	653.0	

INTRODUCTIONS

1. Applications: Electric equipment, UPS, machine tool, copy machine, automation equipment, robot, AC motor drive
2. Voltage rating: 480VAC
3. Operating frequency: 50/60Hz

ELECTRICAL SCHEMATIC

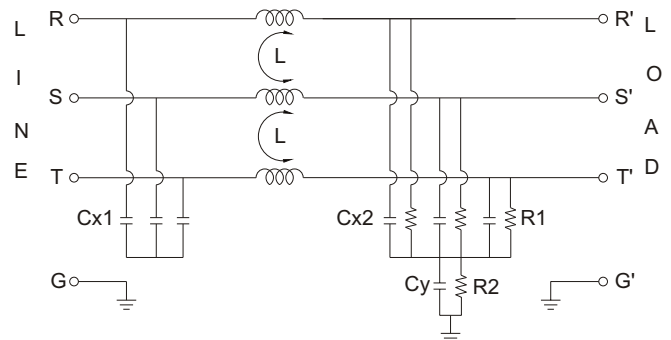

MECHANICAL CONSTRUCTION

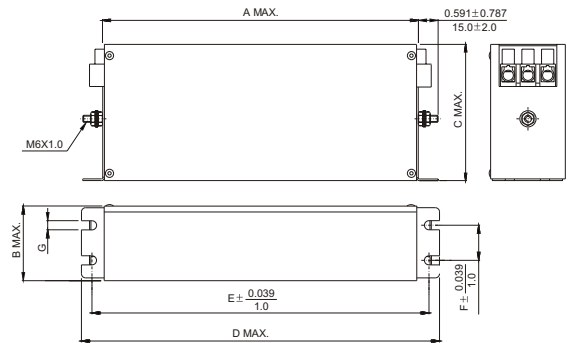

UNIT: INCH / mm

THREE-PHASE FILTERS



TY SERIES

COMPACT 3-PHASE, 4-WIRE FILTERS



COMPONENT

PART NO.	L (mH)	Cx (uF)	Cy (pF)
10TYG9	0.3	0.1	4700
20TYS9	0.15		22000

INTRODUCTIONS

1. Applications: Electric equipment, UPS, machine tool, copy machine, automation equipment, robot, AC motor drive
2. Voltage rating: 440VAC
3. Operating frequency: 50/60Hz

MINIMUM INSERTION LOSS IN dB

COMMON MODE (L-G) IN 50 OHM SYSTEM							
TYPE	CURRENT RATING	FREQUENCY - MHz					
		.15	.50	1.0	5.0	10	30
10TYG9	10A	10	20	20	20	30	25
20TYS9	20A	10	15	20	35	40	25
DIFFERENTIAL MODE (L-L) IN 50 OHM SYSTEM							
10TYG9	10A	10	20	25	25	30	30
20TYS9	20A	10	15	20	20	25	20

ELECTRICAL SCHEMATIC

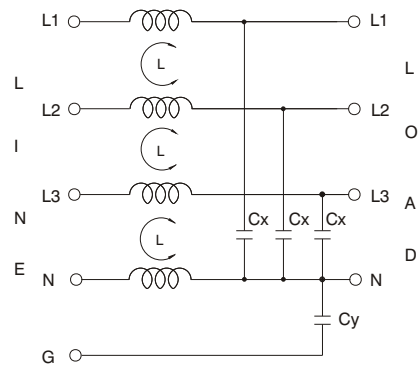

MECHANICAL CONSTRUCTION

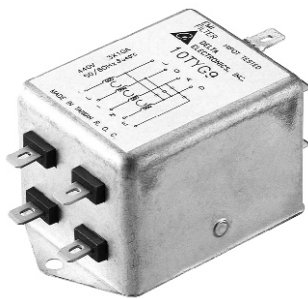

10TYG9

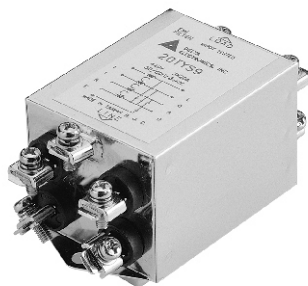
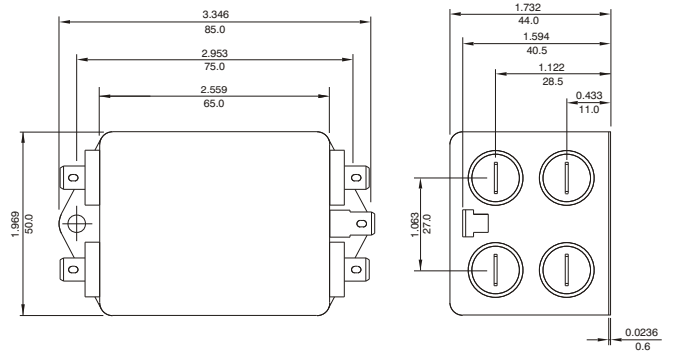

20TYS9

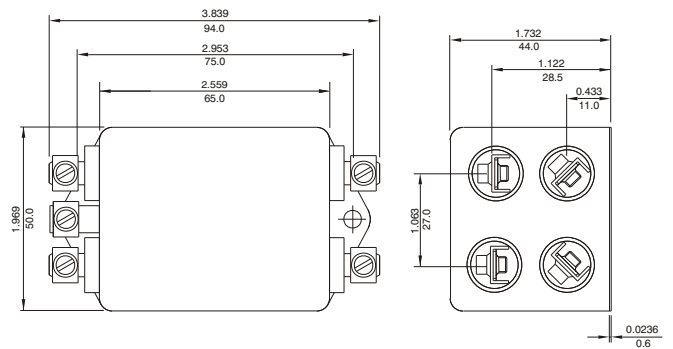

UNIT: INCH
mm

THREE-PHASE FILTERS



TYS SERIES

3-PHASE, 4-WIRE FILTERS

COMPONENTS

PART NO.	C1 (uF)	C2 (uF)	Lg (uH)	L (mH)	R (KΩ)
20TYS10	2.0	1.0	78	3.2	110
• 30TYS10			52	1.6	
60TYS10			52	0.32	

• UL, CSA & SEMKO approved C3: 3300pF C4: 14700pF

INTRODUCTIONS

1. Applications: Electric equipment, UPS, machine tool, copy machine, automation equipment, robot, AC motor drive
2. Voltage rating: 440VAC
3. Operating frequency: 50/60Hz

MINIMUM INSERTION LOSS IN dB

COMMON MODE (L-G) IN 50 OHM SYSTEM							
TYPE	CURRENT RATING	FREQUENCY - MHz					
		.15	.50	1.0	5.0	10	30
20TYS10	20A	25	40	35	30	30	30
30TYS10	30A	25	40	40	45	45	35
60TYS10	60A	15	30	30	30	30	30
DIFFERENTIAL MODE (L-L) IN 50 OHM SYSTEM							
20TYS10	20A	35	35	35	30	30	30
30TYS10	30A	40	55	55	45	45	40
60TYS10	60A	18	45	45	35	35	30

ELECTRICAL SCHEMATIC

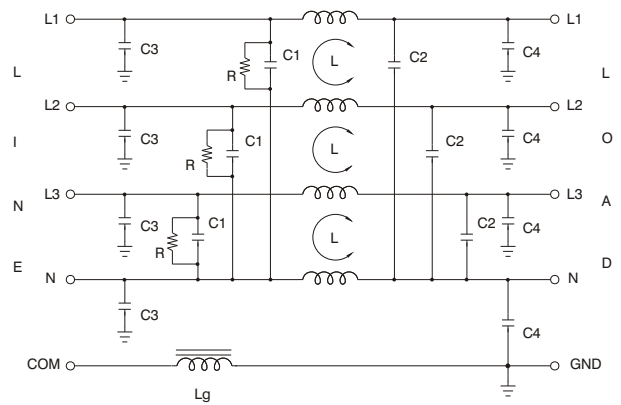

SERIES

DIM.	A	B	C	D	E	F	G	H	I	J	K
20TYS10											
30TYS10	5.59 142.0	4.606 117.0	0.98 25.0	8.85 225.0	6.57 167.0	7.75 197.0	2.55 65.0	1.496 38.0	0.51 13.0	1.81 46.0	0.88 22.4
60TYS10											

MECHANICAL CONSTRUCTION

Optional mounting Flange:

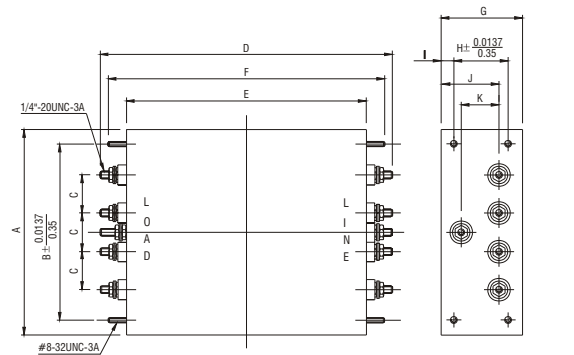
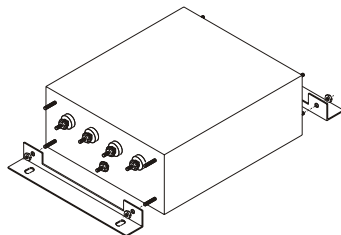
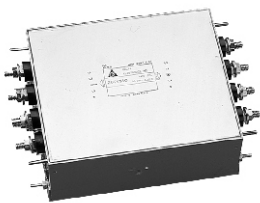

UNIT: INCH
mm



TYS SERIES

HIGH CURRENT 3-PHASE, 4-WIRE FILTERS

COMPONENTS

PART NO.	Cx(uF)	Cy(uF)	L(uH)	R1(KΩ)	R1(MΩ)
200TYSS104	4.7	2.2	3.0	470	1M
300TYSS104	10.0				
400TYSS104	12.2				
500TYSS104	14.7	4.7			
600TYSS104	20.0				

MINIMUM INSERTION LOSS IN dB

COMMON MODE (L-G) IN 50 OHM SYSTEM									
PART Number	FREQUENCY-MHz								
	.01	.05	.10	.15	.50	1.0	5.0	10	30
200TYSS104	5	15	20	20	30	30	15	10	5
300TYSS104	10	25	30	30	35	30	20	15	10
400TYSS104	10	25	30	30	30	20	10	10	5
500TYSS104	5	10	25	25	30	25	15	10	5
600TYSS104	5	10	25	25	35	30	15	10	5
DIFFERENTIAL MODE (L-L) IN 50 OHM SYSTEM									
200TYSS104	10	20	40	40	35	25	15	10	5
300TYSS104	25	35	35	35	35	30	20	15	10
400TYSS104	25	35	35	30	30	25	10	10	5
500TYSS104	20	20	40	40	30	25	15	10	5
600TYSS104	20	20	40	40	35	30	15	10	5

SERIES DIMENSIONS

PART number	DIMENSIONS IN INCHES/mm													
	A	B	C	D	E	F	G	H	I	J	K	L	M	N
200TYSS104	20.669	18.800	15.827	9.528	5.591	17.717	2.362	2.765	0.256x0.315	0.118	Ø0.236	0.591	1.772	M8x1.2
300TYSS104	525.0	477.0	402.0	242.0	142.0	450.0	60.0	70.0	6.5x8.0	3.0	Ø 6.0	15.0	45.0	
400TYSS104														
500TYSS104	26.772	22.520	19.764	10.709	7.165	21.457	2.953	2.953	0.295x0.374	0.236	Ø0.295	0.591	2.165	M12x11.7
600TYSS104	680.0	572.0	502.0	272.0	182.0	545.0	75.0	75.0	7.5x9.5	6.0	Ø7.5	15.0	55.0	

INTRODUCTIONS

1. Applications: Electric equipment, UPS, machine tool, copy machine, automation equipment, robot, AC motor drive
2. Voltage rating: 480VAC
3. Operating frequency: 50/60Hz

ELECTRICAL SCHEMATIC

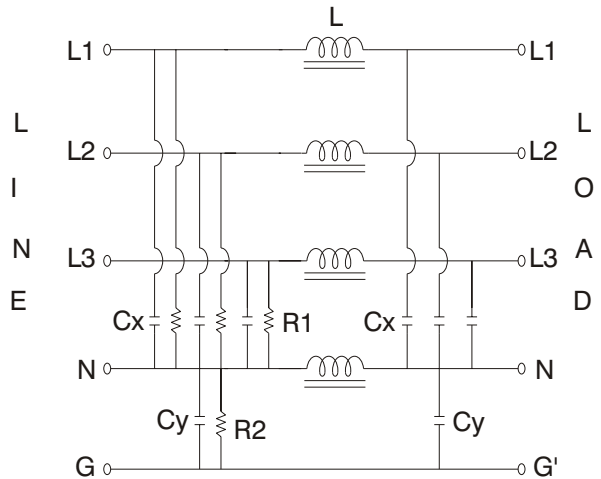

MECHANICAL CONSTRUCTION



200~400A

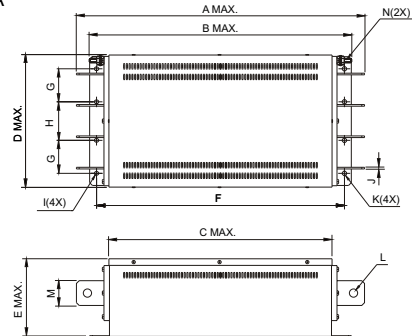

500~600A

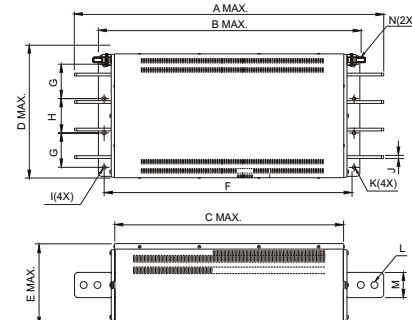

UNIT: INCH/mm



TYT SERIES

HIGH PERFORMANCE 3-PHASE, 4-WIRE FILTERS

COMPONENTS

PART NO.	Cx (uF)	Cx1 (uF)	Cy (nF)	L (mH)	R (KΩ)
16TYT2	0.68	1	15	1.2	220
25TYT2	2	2		1.3	
36TYT2				0.95	
50TYT2				0.55	
100TYSS104	2.2	2.2		47	
150TYSS104	4.4	4.4	200	0.11	

INTRODUCTIONS

1. Applications: Electric equipment, UPS, machine tool, copy machine, automation equipment, robot, AC motor drive
2. Voltage rating: 480VAC
3. Operating frequency: 50/60Hz

MINIMUM INSERTION LOSS IN dB

COMMON MODE (L-G) IN 50 OHM SYSTEM						
PART NO.	FREQUENCY-MHz					
	.15	.50	1.0	5.0	10	30
16TYT2	25	50	50	50	45	30
25TYT2	25	50	50	50	45	30
36TYT2	25	50	50	50	40	25
50TYT2	25	45	45	40	40	25
100TYSS104	10	20	25	30	30	20
150TYSS104	10	20	25	30	30	20

DIFFERENTIAL MODE (L-L) IN 50 OHM SYSTEM						
PART NO.	35	55	60	60	40	30
16TYT2	35	55	60	60	40	30
25TYT2	35	55	60	60	40	30
36TYT2	30	50	55	50	40	30
50TYT2	30	50	50	40	40	30
100TYSS104	30	40	40	35	35	25
150TYSS104	30	40	40	35	35	25

ELECTRICAL SCHEMATIC

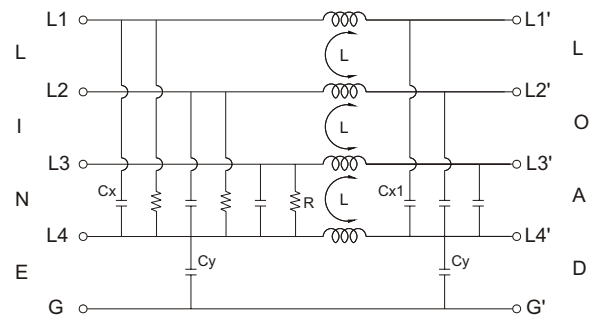

SERIES DIMENSIONS

PART NO.	DIMENSIONS IN INCHES/mm						
	A	B	C	D	E	F	G
16TYT2	5.591 142.0	4.213 107.0	3.228 82.0	7.539 191.5	6.516 165.5	196.9 50.0	7.559 192.0
25TYT2							
36TYT2							
50TYT2	5.689 144.5	4.882 124.0	4.094 104.0	7.638 194.0	6.614 168.0	3.858 98.0	7.638 194.0
*100TYSS104	8.346	6.378	5.197	9.921	9.134	4.724	11.496
*150TYSS104	212.0	162.0	132.0	252.0	232.0	120.0	292.0

* Screw type

MECHANICAL CONSTRUCTION

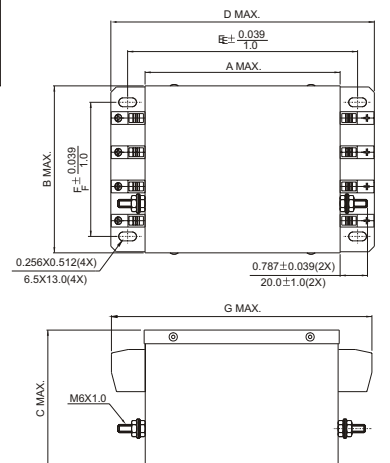
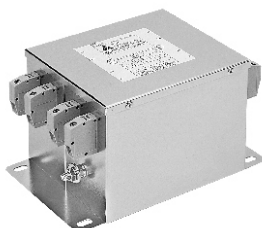

UNIT: INCH/mm



TDT & DRT SERIES

EMI FILTER FOR INVERTERS

COMPONENTS

PART NO.	Cx1 (uF)	Cx2 (uF)	Cy (nF)	L (mH)	Lg (uH)	R (KΩ)
16DRT1W3A	1.0	0.68	4.7	1.7	32	200
*30DRT1W3	2.2	1.0	10	2.2	-	

*UL APPROVED

INTRODUCTIONS

1. Applications: Electric equipment, UPS, machine tool, copy machine, automation equipment, robot, AC motor drive
2. Voltage rating: 250VAC
3. Operating frequency: 50/60Hz

MINIMUM INSERTION LOSS IN dB

COMMON MODE (L-G) IN 50 OHM SYSTEM									
PART NO.	FREQUENCY-MHz								
	.01	.05	.10	.15	.50	1.0	5.0	10	30
16DRT1W3A	5	5	20	30	60	65	65	65	55
30DRT1W3	5	10	20	25	40	45	50	50	35
DIFFERENTIAL MODE (L-L) IN 50 OHM SYSTEM									
16DRT1W3A	2	10	10	25	55	60	60	60	60
30DRT1W3	5	10	35	40	60	60	50	50	35

ELECTRICAL SCHEMATIC

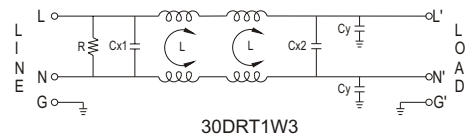
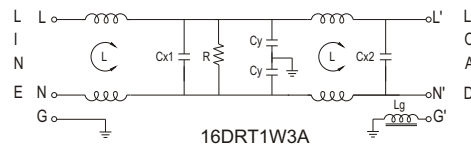

SERIES DIMENSIONS

PART NO.	DIMENSIONS IN INCHES/mm							
	A	B	C	D	E	F	G	H
16DRT1W3A	8.740	5.197	1.654	7.795	3.937	9.843	7.795	0.787
	222.0	132.0	42.0	198.0	100.0	250.0	198.0	20.0
30DRT1W3	10.906	7.956	2.047	9.961	6.693	7.874	9.961	0.984
	277.0	202.0	52.0	253.0	170.0	200.0	253.0	25.0

INSERTION LOSS (TYPICAL)

50TDS4W4 ----- COMMON MODE ----- DIFF. MODE

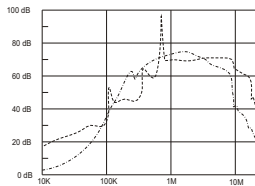

10TDT1W4 ----- COMMON MODE ----- DIFF. MODE

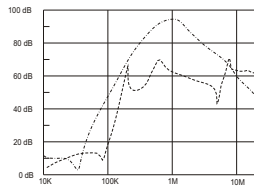

20TDT1W4 ----- COMMON MODE ----- DIFF. MODE

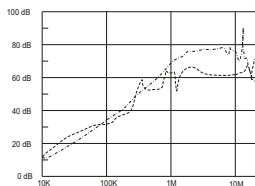

16DRT1W3A ----- COMMON MODE ----- DIFF. MODE

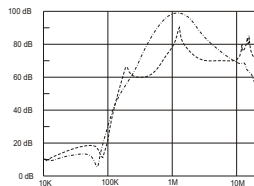

MECHANICAL CONSTRUCTION

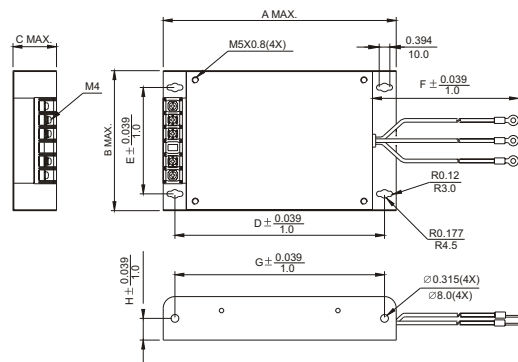
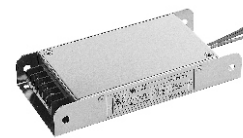

THREE-PHASE FILTERS



TDT & DRT SERIES

EMI FILTER FOR INVERTERS



COMPONENTS

PART NO.	Cx1(uF)	Cx2(uF)	Cy(nF)	L(mH)	Lg(uH)	R(KΩ)
10TDT1W4	0.68	-	10	23	5.2	560
10TDT1W4B	4.4	0.68	200	1.5	-	100
20TDT1W4		0.08	20		-	
21TDT1W4		1.0	47		800	
PART NO.	L (mH)	L1 (mH)	Cx (uF)	Cy (nF)	R (KΩ)	
50TDS4W4	0.5	0.2	6.6	100	100	

MINIMUM INSERTION LOSS IN dB

COMMON MODE (L-G) IN 50 OHM SYSTEM						
PART NO.	FREQUENCY-MHz					
	.15	.50	1.0	5.0	10	30
10TDT1W4	40	65	65	65	50	45
10TDT1W4B	60	60	60	60	40	35
20TDT1W4	25	35	40	50	40	25
21TDT1W4	45	65	65	60	30	15
50TDS4W4	40	65	65	45	35	5
DIFFERENTIAL MODE (L-L) IN 50 OHM SYSTEM						
10TDT1W4	10	40	50	45	45	50
10TDT1W4B	35	40	40	40	40	35
20TDT1W4	30	60	60	50	40	40
21TDT1W4	35	45	45	40	40	30
50TDS4W4	30	40	30	25	25	5

SERIES DIMENSIONS

PART NO.	DIMENSIONS IN INCHES/mm										
	A	B	C	D	E	F	G	H	I	J	K
10TDT1W4	8.740	5.197	1.654	7.795	3.397	9.843	7.795	0.787	-	-	-
	222.0	132.0	42.0	198.0	100.0	250.0	198.0	20.0	-	-	-
10TDT1W4B	10.906	7.956	2.047	9.961	6.693	7.874	9.961	0.984	-	-	-
20TDT1W4	277.0	202.0	52.0	253.0	170.0	200.0	253.0	25.0	-	-	-
21TDT1W4											
50TDS4W4	322	92	152	340	60	300	-	Ø7.0	7.0x10.0	M6x1.0	363
	12.68	3.62	5.98	13.39	2.362	11.81	-	Ø0.28	0.28x0.39		

MECHANICAL CONSTRUCTION

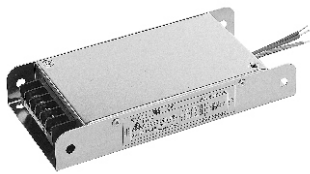

10TDT1W4/10TDT1W4S
20/21TDT1W4

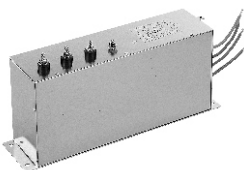

50TDS4W4

INTRODUCTIONS

1. Applications: Electric equipment, UPS, machine tool, copy machine, automation equipment, robot, AC motor drive
2. Voltage rating: 480VAC
3. Operating frequency: 50/60Hz

ELECTRICAL SCHEMATIC

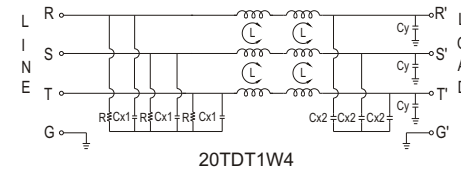
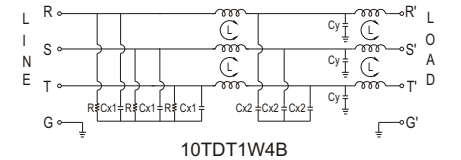
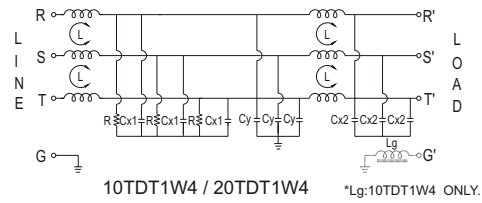

THREE-PHASE FILTERS

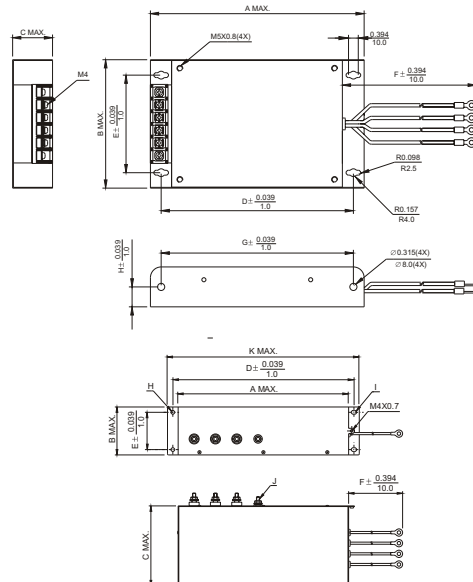

UNIT: INCH/mm



PT&PY SERIES 3-PHASE P.C.B. FILTERS

COMPONENT

PART NO.	Cx1(uF)	Cx2(uF)	Cy(uF)	L(mH)	Z(VDC)	SA(VDC)
30PTW6	0.68	0.22	0.0033	1.0	—	—
30PYT8	0.33		0.0047	0.45	470	3600

MINIMUM INSERTION LOSS IN dB

PART NO.	COMMON MODE(L-G)IN 50 OHM SYSTEM							
	FREQUENCY-MHz							
	.05	.10	.15	.20	.50	1.0	5.0	10
30PTW6	/	/	/	20	30	35	35	35
30PYT8	1	5	8	20	25	35	20	8
PART NO.	DIFFERENTIAL MODE(L-L)IN 50 OHM SYSTEM							
30PTW6	/	/	/	15	35	35	35	35
30PYT8	6	10	10	15	45	55	45	25

SERIES DIMENSIONS

PART NO.	DIMENSIONS IN INCHES/mm					
	A	B	C	D	E	F
30PTW6	5.906	3.543	5.315	2.953	0.126	—
	150.0		135.0	75.0	3.2	—
30PYT8	7.874	90.0	4.961	2.559	3.189	0.165
	200.0		126.0	65.0	81.0	4.2

MECHANICAL CONSTRUCTION

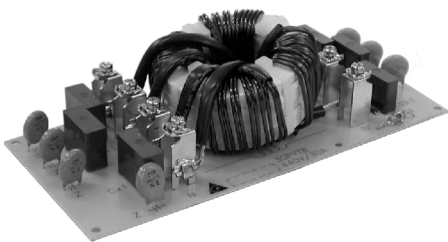
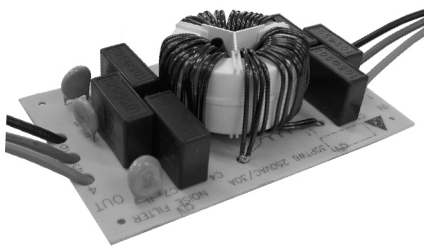

INTRODUCTIONS

1. Applications: Electric equipment, UPS, machine tool, copy machine, automation equipment, robot, AC motor drive
2. Voltage rating: 250/480VAC
3. Operating frequency: 50/60Hz

ELECTRICAL SCHEMATIC

30PTW6(250VAC)

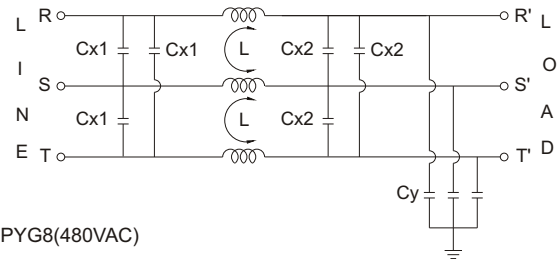

30PYG8(480VAC)

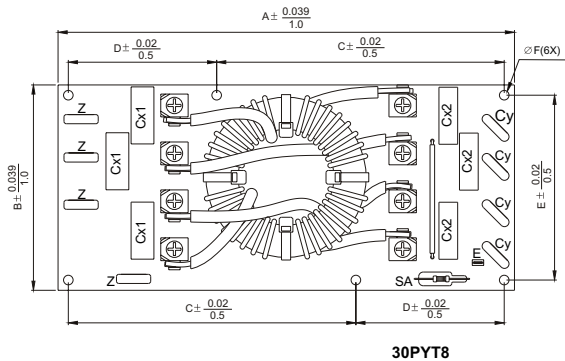
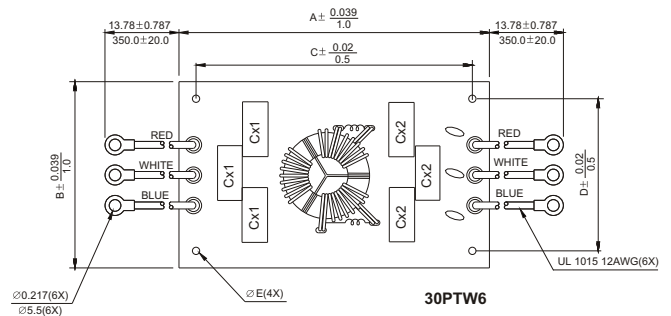
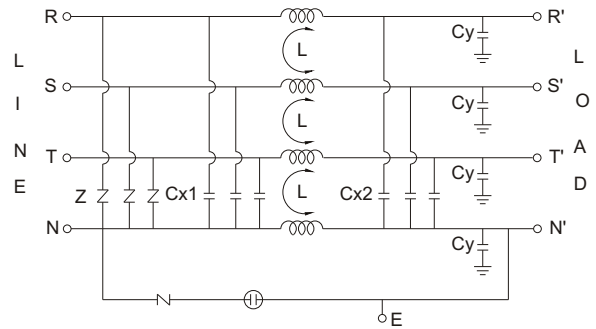

UNIT: INCH/mm

THREE-PHASE FILTERS



MB SERIES HIGH PERFORMANCE CYLINDRICAL FILTERS

INTRODUCTIONS

1. MB series is designed as a compact, easy-to-mount cylindrical filter for switching power supplies, office equipment (copy and facsimile machines) and household appliances (washing machines and dryers).

COMPONENTS

PART No.	L (mH)	Cx (uF)	Cy (pF)	R(KΩ)	Safety
10MBFG5	0.5	0.47	10000	680	
16MBFG5	1.0	0.47	10000	680	

MINIMUM INSERTION LOSS IN dB

COMMON MODE (L-G) IN 50 OHM SYSTEM							
TYPE	CURRENT RATING	FREQUENCY-MHz					
		.15	.50	1.0	5.0	10	30
10MBFG5	10A	5	19	27	44	32	21
16MBFG5	16A	11	26	31	30	20	4
DIFFERENTIAL MODE (L-L) IN 50 OHM SYSTEM							
10MBFG5	10A	1	12	20	19	20	22
16MBFG5	16A	11	24	12	14	17	28

ELECTRICAL SCHEMATIC

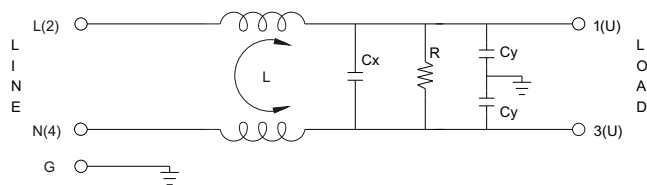

MECHANICAL CONSTRUCTION



SPECIFICATIONS

- Maximum leakage current each line-to-ground @115VAC 60Hz: 1.0mA @250VAC 50Hz: 2.0mA
- Hipot rating (one minute) line-to-ground: 2250VDC line-to-line: 1450VDC
- Operating frequency: 50/60 Hz
- Rated voltage: 115/250VAC

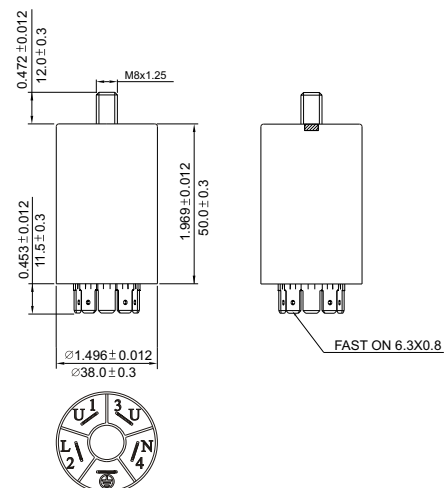
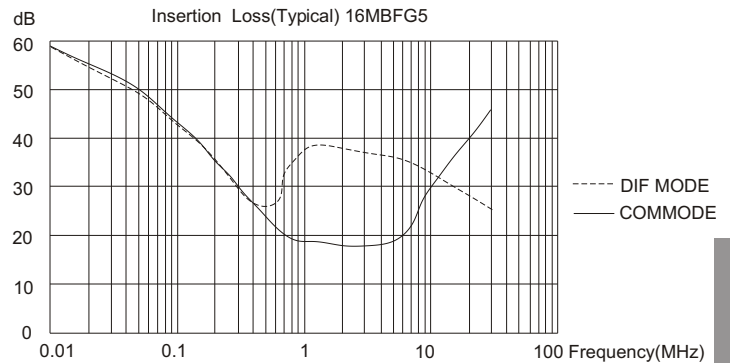
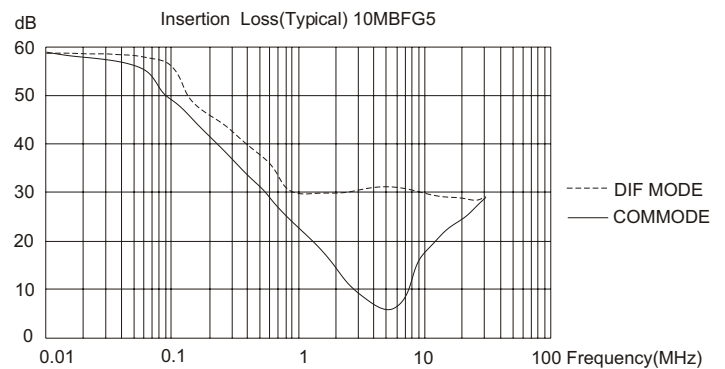

GENERAL PURPOSE ONE-STAGE FILTERS

UNIT: INCH
mm



www.deltaww.com

DELTA ELECTRONICS, INC.

186 RUEY KUANG ROAD, NEIHU,
TAIPEI 11491, TAIWAN
REPUBLIC OF CHINA
TEL : 886-2-8797-2088
FAX : 886-2-8797-2120

DELTA ELECTRONICS (DONGGUAN) CO., LTD.

DELTA INDUSTRIAL ESTATE, SHIJIE TOWN,
DONGGUAN, GUANGDONG,
PEOPLE'S REPUBLIC OF CHINA
POST CODE : 523308
PLANT1 TEL : 86-769-663-5008 FAX : 86-769-663-4479
PLANT2 TEL : 86-769-663-9008 FAX : 86-769-663-8777
PLANT3 TEL : 86-769-663-1008 FAX : 86-769-663-7012
PLANT4 TEL : 86-769-632-9008 FAX : 86-769-663-1589
PLANT5 TEL : 86-769-663-7008 FAX : 86-769-663-7007

DELTA ELECTRONICS (JIANG SU) LTD.

18 JIANGXING EAST ROAD,
YUN DONG DEVELOPMENT ZONE,
SONG LING TOWN, WUJIANG CITY,
JIANG SU PROVINCE,
PEOPLE'S REPUBLIC OF CHINA
POST CODE: 215200
PLANT1 TEL : 86-512-6340-1008 FAX : 86-512-6340-1564
PLANT2 TEL : 86-512-6340-3008 FAX : 86-512-6340-7190
PLANT3 TEL : 86-512-6340-3008 FAX : 86-512-6340-7190

DELTA GREEN TIANJIN INDUSTRIES CO., LTD.

168 NO.15 COASTAL WAY,
TIANJIN PORT FREE TRADE ZONE,
PEOPLE'S REPUBLIC OF CHINA
TEL : 86-22-2576-0371
FAX : 86-22-2576-0380

DELTA ELECTRONICS (JAPAN) INC.

DELTA SHIBADAIMON BUILDING,
2-1-14 SHIBADAIMON, MINATO-KU,
TOKYO, 105-0012
JAPAN
TEL : 81-3-5733-1111
FAX : 81-3-5733-1211

DELTA ELECTRONICS (SINGAPORE) PTE. LTD.

NO. 8 KAKI BUKIT ROAD 2,
#04-18 RUBY WAREHOUSE COMPLEX,
SINGAPORE 417841
TEL : 65-747-5155
FAX : 65-744-9228

**DELTA ELECTRONICS (THAILAND)
PUBLIC COMPANY, LIMITED**

111 MOO 9 WELLGROW INDUSTRIAL ESTATE
BANGNA-TRAD RD., TAMBON BANGWUA,
AMPHUR BANGPAKONG
CHACHOENGSAO 24180, THAILAND
TEL : 66-38-522480
FAX : 66-38-522490

DELTA ELECTRONICS (EUROPE), LTD.

AMSTERDAM OFFICE

WEGALAAN 16,
2132 JC HOOFFDORP,
THE NETHERLANDS
TEL : 31-23-566-8927
FAX : 31-23-566-8910

VENLO OFFICE

INDUSTRIEGEBIED VENLO NR. 9031,
COLUMBUSWEG 20, NL-5928 LC VENLO,
THE NETHERLANDS
TEL : 31-77-324-1930
FAX : 31-77-324-1931

GLASGOW OFFICE

1 REDWOOD COURT, PEEL PARK ,
EAST KILBRIDE, G74 5PF, SCOTLAND,
UNITED KINGDOM
TEL : 44-1355-588-888
FAX : 44-1355-588-889

IRELAND OFFICE

UNIT 5, PLASSEY ENTERPRISE CENTER,
NATIONAL TECHNOLOGY PARK,
CASTLETROY, CO LIMERICK,
IRELAND
TEL : 353-61-336-233
FAX : 353-61-336-240

DELTA PRODUCTS CORPORATION

FREMONT OFFICE

4405 CUSHING PARKWAY,
FREMONT, CA 94538,
U.S.A.
TEL : 1-510-668-5100
FAX : 1-510-668-0680

PORTLAND OFFICE

15125 SW KOLL PARKWAY,
SUITE K, BEAVERTON, OR 97006,
U.S.A.
TEL : 1-503-533-8444
FAX : 1-503-533-0204

LOS ANGELES OFFICE

927 CANADA COURT,
CITY OF INDUSTRY, CA 91748,
U.S.A.
TEL : 1-626-581-8666
FAX : 1-626-581-2186

HOUSTON OFFICE

8270 WILLOW PLACE NORTH,
SUITE 150, HOUSTON, TX 77070,
U.S.A.
TEL : 1-281-477-9400
FAX : 1-281-477-9438

SAN DIEGO OFFICE

17150 VIA DEL CAMPO #303,
SAN DIEGO, CA 92127,
U.S.A.
TEL : 1-858-676-8282
FAX : 1-858-676-0338

RALEIGH OFFICE

P.O. BOX 12173,
5101 DAVIS DRIVE,
RESEARCH TRIANGLE PARK, NC 27709
U.S.A.
TEL : 1-919-767-3800
FAX : 1-919-767-8080

BOSTON OFFICE

175 CABOT STREET, SUITE #310,
LOWELL, MA 01854,
U.S.A.
TEL : 1-978-656-3993
FAX : 1-978-656-3964

AUSTIN OFFICE

575 ROUND ROCK WEST DRIVE,
BUILDING K, SUITE #440,
ROUND ROCK, TX 78681,
U.S.A.
TEL : 1-512-671-7749
FAX : 1-512-671-7726

DAKOTA OFFICE

3500 SOUTH LAKEPORT STREET, #H,
SIOUX CITY, IA 51106,
U.S.A.
TEL : 1-712-274-8814
FAX : 1-712-274-8816