

3M Science.
Applied to Life.™

3M Welding Safety Catalog 2016

Passion for Welding

www.3m.eu/speedglas

 **Speedglas**™

Empowering information

Welcome to our comprehensive guide to eye, face and respiratory protection for welders.

In this guide we have compiled our welding filters, helmets, respiratory systems, accessories, spare parts and technical data into one handbook for your easy reference.

We are proud to empower welders to select the optimized combination of 3M personal protective equipment for their improved safety, comfort and long-term health.

Content

Welding eye, face and head protection	6
Welding respiratory protection	26
Frequently asked questions	34
Parts directory	37
Care and maintenance	59
Technical specifications	62
Product index	63

New products:



◀ 3M™ Speedglas™ Quick Release Rail System (QR)

Continuous head protection for welders. And no more wearing a welding helmet when you do not need it. [Read more on page 11.](#)

▶ 3M™ Speedglas™ Welding Filter Kit 9100XXi

The new auto-darkening filter kit for the 3M™ Speedglas™ Welding Helmet Series 9100 is your window to a new world of more realistic color and detail – to help you weld, grind and see your finish. [Read more on page 9.](#)



Speedglas online

Direct access to knowledge, via your computer, laptop or mobile:

www.3M.com/Speedglas

Access our latest news, learn more about welding safety and explore the online product catalog:

- Quick product search
- Compare products
- Download information

Use your smartphone or tablet to explore the new Speedglas product guide

app.speedglas.com

- Product overview
- Sort by feature
- Selection guide, etc.



Follow us on
social media

Subscribe to www.youtube.com/3MSpeedglas



Join www.facebook.com/3MSpeedglas



Tag us on Instagram [@3MSpeedglas](https://www.instagram.com/3MSpeedglas)



◀ 3M™ Adflo™ Powered Air Respirator

The Li-ion batteries makes the Adflo respirator even more lightweight. Further details on [page 26](#).



More than 35 years ago, we went to the shipyards of Sweden to study welders' working conditions. We found skilled craftsmen striking arcs as they continually nodded their shields down. From that point on, we committed ourselves to developing tools that would forever improve the world of the welder. From the first groundbreaking auto-darkening welding helmet in 1981 to our current lineup of state-of-the-art welding safety products, we continue to revolutionize your world.

Inspired by your reality

We have a passion for welding and we know the challenges of your profession. We share the passion and pride you put into your welding. So it is natural for us to want to help address the ergonomic, safety, and health challenges facing your every day. Your thoughts and opinions are the bottom line in our continuous search for innovation. Inspired by your reality, we shape the future of welding so you can get on with the job of shaping ours.



3M™ Speedglas™ Welding Helmet 9100



High performing
products and people

3M™ Speedglas™ Welding Helmet Series 9100

– our top-of-the-line safety platform for professional welders

In the product development process for our 4th generation of 3M™ Speedglas™ Welding Helmets, we systematically studied welders to identify global customer needs of a welding helmet.

The result was a long list of welding helmet concerns important to the welder, where the three highest ranked became key factors applied in each model within the 3M™ Speedglas™ Welding Helmet Series 9100.

Project start



Voice of customer summary

- 1 Protection against radiation
- 2 Comfortable to wear
- 3 Reliable performance



Protection

1 Coverage is key!

Helmet coverage is a concern among many welders. So we made the 9100 Series Welding Helmets deeper and wider, improving coverage of ears, neck and sides of the head from heat and welding sparks. In addition there are several accessories available to extend coverage.

2 More comfort, less fog

Less pressure and stable fit means improved comfort: The 9100 High-comfort Headband is designed to help avoid pressure on vulnerable areas of the head. It also provides several adjustment combinations for personal tailoring and helmet stability.

The 9100 series helmet's exhaust vents help reduce heat, humidity and fogging of the welding filter.

3 Reliable performance!

The key to remember with 3M™ Speedglas™ Auto-darkening Welding Filters is consistency. They enable consistent, comfortable viewing and provide protection from ultraviolet (UV) and infrared (IR) radiation, at all times, in all states. They consistently auto-switch from light state to dark state, and back again, to help increase productivity while you weld.

Field trials and quality verifications

Real-world validation of design concepts and international field trials of prototypes are used to verify our products before they are released. Multiple rigorous objective tests are made to ensure all products meet or exceed international safety standards and requirements well before they reach end-users.

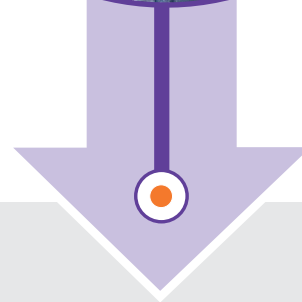

The 3M™ Speedglas™ Welding Helmet Series 9100 includes six welding helmet models offering many options, including flip-up welding shields, hard hats, and respiratory systems. If you haven't experienced these innovations in welding protection, call your local 3M reseller for a hands-on demonstration.



Excellent Optics, Wider Views

The 3M™ Speedglas™ Auto-Darkening Filters Series 9100 continue our tradition of outstanding optical quality, including uniform shading and minimal distortion across the entire filter viewing area.

- The 3M™ Speedglas™ Filter 9100XX is 30% larger than any other Speedglas welding filter.
- Seven dark shades, including 9–13 (variable), 5 for gas welding/cutting, and 8 for micro-plasma or low-amp TIG.
- Outstanding low-amp TIG performance, even on settings as low as 1 amp.
- Any shade can be “locked-in.” For example, you can lock-in the light state shade 3 for grinding.
- Exclusive, innovative “tack welding comfort mode” which can help reduce eye strain -available on 9100 V, X,XX lenses.



The Speedglas welding filter series 9100 includes three auto-darkening filters: regular, large, and extra-large viewing area.

Magnification made easy. The magnifying lens holder is built into the welding filter, making lens installation easier.

Seven user selectable dark shades for most types of arc welding.



The tack welding comfort mode uses an intermediate shade 5 light state to help minimize eye strain during extended tack welding applications.

The Delay function allows you to set the dark-to-light switching time.

You can adjust the sensitivity of the arc detection for switching reliability.

Seeing is believing. See your work in a brand new light.

With improvements based on input from master welders around the world, the 3M™ Speedglas™ Welding Filter 9100XXi sets a new standard for visibility, convenience and ease of use.

A new level of visibility and control

Improved optics deliver more natural color and contrast, which may allow:

- Better control of the weld puddle with a view that appears lighter, brighter and more realistic
- Greater precision with set-up and finishing operations
- Simplified workflow with convenient, “gloves-on” memory mode switching – plus a clearer view of welding machine controls
- Auto ON/OFF
- New user interface
- Dark shades 5, 8, 9-13



Learn more at
3m.com/SpeedglasXXi.



More natural colors

The difference is easy to see. Yes, the light state is still shade 3! But what you see through the filter seems lighter, more detailed and colorful. In fact, the improved welding filter optics can make your entire viewing experience feel more natural.



External controls and memory function

The newly redesigned silver front included in the 3M™ Speedglas™ Welding Filter Kit 9100XXi houses external controls, enabling fast and easy access to the grinding and memory modes. A new motion-sensor to the 9100 instantly turns ON the welding filter when you pick up the helmet.

The headband that shapes to your head

The Speedglas 9100 series welding helmets feature a highly adjustable, comfortable headband. The outside of the human head is lined with nerves, arteries, and acupressure points. The 9100 headband specifically avoids these vulnerable areas.

And it provides multiple adjustment combinations so you can “tailor” the helmet to fit your personal preferences and comfort settings, while increasing helmet stability.

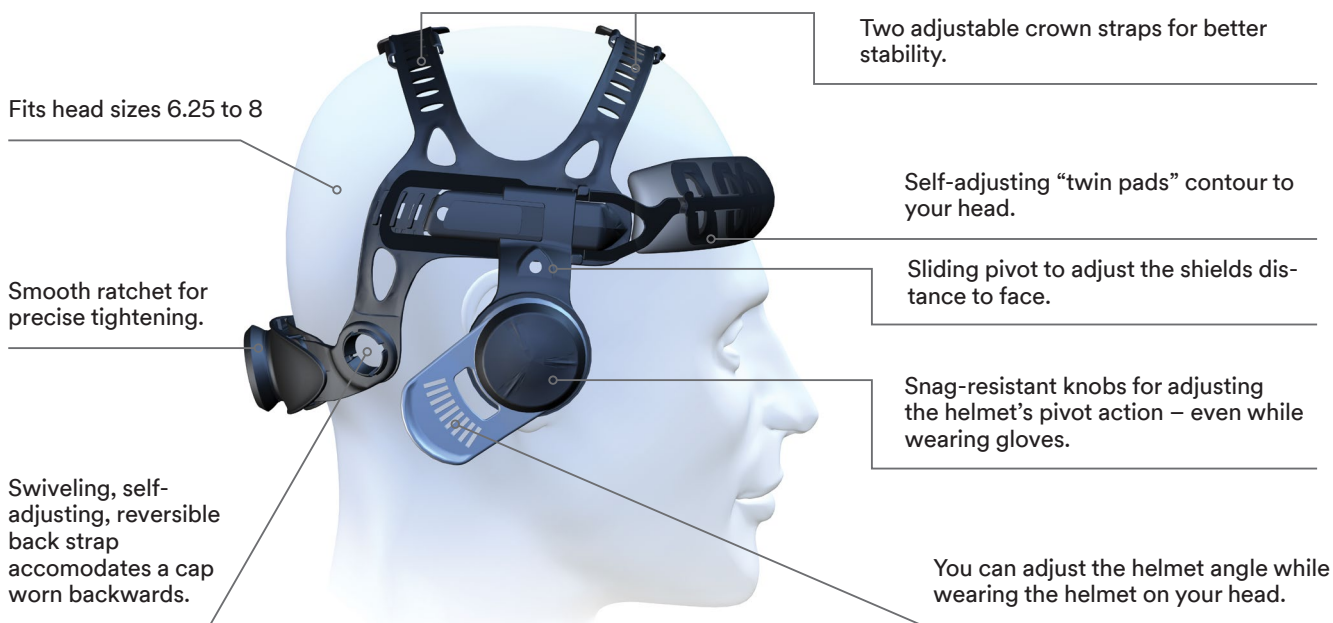

More comfortable when raised

Lifted into the raised position, the helmet’s “high point” is lower than many other helmets. From a design standpoint that means keeping the helmet as close as possible to your head. Because the helmet is more balanced, you may not need to tighten the headband as much, further increasing your wearing comfort.

Parking position

The smooth up-and-down pivot action can be locked in the up position – a light pull lowers the helmet back down again.



Continuous head protection for welders

Designed to fit many of the industry's hard hats*, the 3M™ Speedglas™ Quick Release (QR) Rail swiftly clasps onto your hard hat via a releasable ratcheting mechanism. With the rail installed, you can easily detach the welding visor, keeping your hard hat protection in place as you perform non-welding tasks.

Quickly Connect/Disconnect

Even with a gloved hand, you can easily attach the 3M™ Speedglas™ Welding Helmet 9100-QR (or 100-QR). When your welding work is finished, you can detach the welding helmet as quickly as you take off a baseball cap. You never need to remove the hard hat from your head. As you attach and detach the welding helmet, you never need to remove your hard hat – so your head is protected at all times. †

*please refer to user instructions



Use Your Hard hat ...Or Ours

The 3M™ Speedglas™ Quick Release (QR) Rail allows you to attach a Speedglas auto-darkening welding helmet to certain range of the industry's most popular hard hats. We recommend using a hard hat with a ratchet headband, for better stability.

3M offers a complete welding helmet system including the 3M™ Hard hat H-701.



See videos and learn more about Speedglas quick release welding helmets, visit 3M website:

www.3M.eu/quickrelease

Or scan this QR-code:

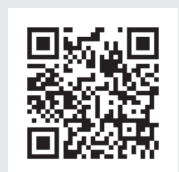

Flexible and comfortable

Your head is protected at all times because you never need to remove your hard hat as you attach and detach the welding helmet! If you prefer to keep the welding helmet attached, it is quickly parked in the raised position.

This parked position creates a low center of gravity, helping to reduce the forces on your neck while letting you move around more easily thanks to the low profile.

Even with a gloved hand, you can easily attach the 3M™ Speedglas™ Welding Helmet 9100-QR.

The Quick Release (QR) Rail allows you to attach the Speedglas auto-darkening welding helmet 9100-QR to many of the industry's hard hats*.

*please refer to user instructions

3M offers a complete welding helmet system including the 3M™ Hard hat H-701.

Ultraviolet (UV) and infrared (IR) protection at all times, in all states.

Designed from inception to accept 3M™ PELTOR™ Earmuffs.

Works with Speedglas filter series 9100, including the top-of-the-line 9100XXi auto-darkening filter.

Expand your view: Two-shade 5 passive side windows add peripheral welding vision.

Exhaled air is channeled out via side exhaust vents.

*please refer to user instructions



The 3M™ H-701 is a full-featured hard hat, capable of accepting integrated eyewear and earmuffs in addition to the Speedglas welding helmet 9100-QR.



Multiple Features

Head, eye, face, hearing and respiratory options – we’ve seamlessly integrated welder protection into one comfortable and easy-to-use system.

It’s an ideal combination designed to ignite your confidence and productivity all shift long. APF 25.

Compatible, versatile protection: Works with Speedglas filter series 9100, including the top-of-the-line 9100XXi auto-darkening filter.

Expand your view: Two shade 5 passive side windows add peripheral welding vision.

See more: Large (approx. 8” x 4.25”) curved protective visor has excellent views up, down and peripherally.



The hard hat shell is made from heat resistant polycarbonate and meets the ANSI Z89.1-2009 requirements for Type 1 Class G hard hats. An optional, aluminized fabric reflects radiant welding heat.



Designed from inception to take our optional 3M™ PELTOR™ Earmuff Assembly M-985: low-profile hearing protection with liquid/foam ear cushions and orange housings. NRR 26dB.



Look Around... Really Look Around

The clear protective visor is wide (approx 8 in. x 4.25 in), curved and offers great views up, down and side-to-side. It’s perfect for prepping and inspecting welds... and just walking around your facility. Then, pull down your welding shield and appreciate the side windows views: you can have peripheral vision at all times, even when welding.

Designed for protection

Protecting your eyes and face from radiation, heat and sparks – while providing a precise view of your work – makes your Speedglas welding helmet 9100 one of your most important welding tools.



reddot design award
best of the best 2009



product
design
award

2009

A selection of welding filters with superior optical performance for continuous viewing comfort. Arc detection down to 1 amp TIG.

High-comfort Speedglas headband 9100.

Large coverage for ear and side of head.

Ultraviolet (UV) and infrared (IR) protection at all times, in all states.

Expand your view:
Two-shade 5 passive side windows add peripheral welding vision.

Exhaled air is channeled out via side exhaust vents.

Meets the requirements of CSA Z94.3 and the high impact requirements of ANSI Z87.1 - 2010.



Exhaust vents readily direct your exhaled air out of the helmet and reduces the likelihood of a foggy welding filter.

Respiratory welding helmet

All of the benefits of the 9100 welding helmets can be used in combination with powered or supplied air respiratory protection APF 25. See further details of respirator compatibility on page 52.



Airflow: The middle channel keeps the filter virtually fog-free, while two side channels provide smoothly distributed air to the area of your mouth and nose.

Extended protection: A flame-retardant headcover (used in this application) and ear/neck protection are available as accessories.



Wider field of view with flip-up front

Speedglas welding helmet 9100 FX, a flip-up combination of an auto-darkening welding helmet and a protective visor. Not only is the viewing area larger

compared to previous models, we totally redesigned the geometry of the helmet for a wider field of view in all directions.

Expand your view:
Two-shade 5 passive side windows add peripheral welding vision.

Can take the heat:
Spark- and spatter-retardant head cover.

High-comfort
Speedglas
headband 9100.

Exhaled air is channeled out
via side exhaust vents.



Superior optical performance with flip-up view. Works with Speedglas filter series 9100, including the top-of-the-line 9100XXi auto-darkening filter.

The approx. 8 × 4.25 in. (17 × 10 cm) clear protective visor is curved, increasing your peripheral vision.

Meets the requirements of CSA Z94.3 and the high impact requirements of ANSI Z87.1 - 2010.



Using the hard hat adapter, you can easily fit many of the industry's hard hats with the Speedglas welding helmet 9100 FX.



As additional head and neck coverage there are flame-retardant accessories to help to protect from molten metal, sparks and flames.

Excellent view and respiratory protection!

The Speedglas welding helmet 9100 FX-Air combines respiratory protection and excellent vision in a flip-up model.

Versatile protection and long-lasting comfort. This helmet readily connects both to powered and supplied air respirator systems. APF 25.

Meets the requirements of CSA Z94.3 and the high impact requirements of ANSI Z87.1 - 2010.

Superior optical performance with flip-up view. Works with Speedglas filter series 9100, including the top-of-the-line 9100XXi auto-darkening filter.

Expand your view: Two-shade 5 passive side windows add peripheral welding vision.

Respiratory protection – APF of 25.

Can take the heat: Spark- and spatter-retardant head cover.

Assigned protection factor of 25.

Secure and stable attachment of breathing tube.

The innovative 3M™ Quick Release Swivel (QRS) enables one-handed breathing tube connection and release.



To help increase comfort, air is directed toward the face. An optional diffuser broadens and reduces the speed of the airflow for your maximum comfort.



A quick lift of the silver front and you get a clear approx. 8 x 4.25 in. (17x10 cm) view – perfect for precision grinding in low light conditions, while maintaining respiratory protection.



“I forget I’m
Wearing it”

When Your #1 Priority is Super Light

At a mere 13 oz (379 grams) — including its auto-darkening filter — the Speedglas welding helmet SL is 25% lighter than any other Speedglas welding helmet model.



Our narrowest helmet: perfect for many super tight spaces.

Five adjustable dark shades 8–12 and a light shade of 3. Four sensitivity settings.

Grab & Go:
A motion sensor automatically turns ON the welding filter when you pick up the helmet.

Appropriate for most arc welding processes — such as Stick, MIG/MAG, TIG and plasma welding.

Dark shade can be increased to 13 or 14 using upgrade plates.



Quick and light, perfect for fast tasks

Using specialized manufacturing techniques, we greatly reduced the weight of the auto-darkening filter. And unlike some other lightweight helmets that can absorb moisture and become heavy, the Speedglas welding helmet SL is made from a strong, non-absorbent material.

Designed for quick welding tasks, a motion sensor automatically turns ON the welding filter when you pick up the helmet.

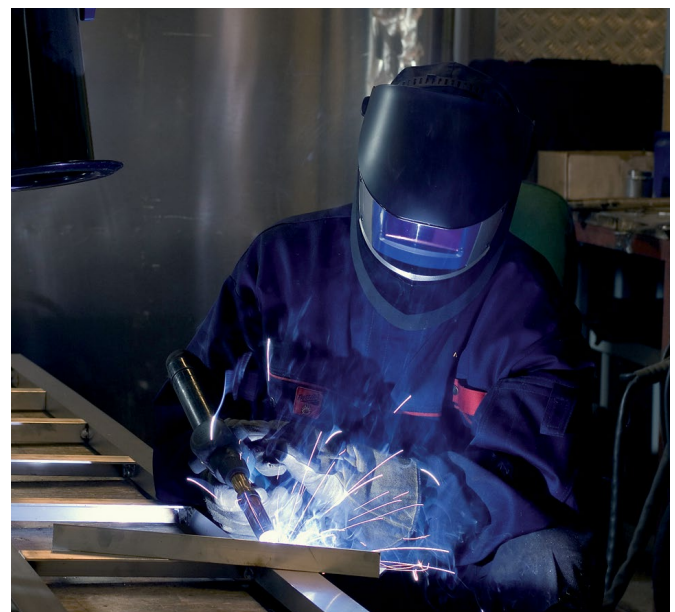



Premium
Made Affordable

High-End Features, Affordable Price

The Speedglas welding helmet 100 allows you to take advantage of excellent optical quality and reliable light-to-dark switching at an affordable price.

In addition to the black model, you can choose from several highly creative graphic helmet designs.

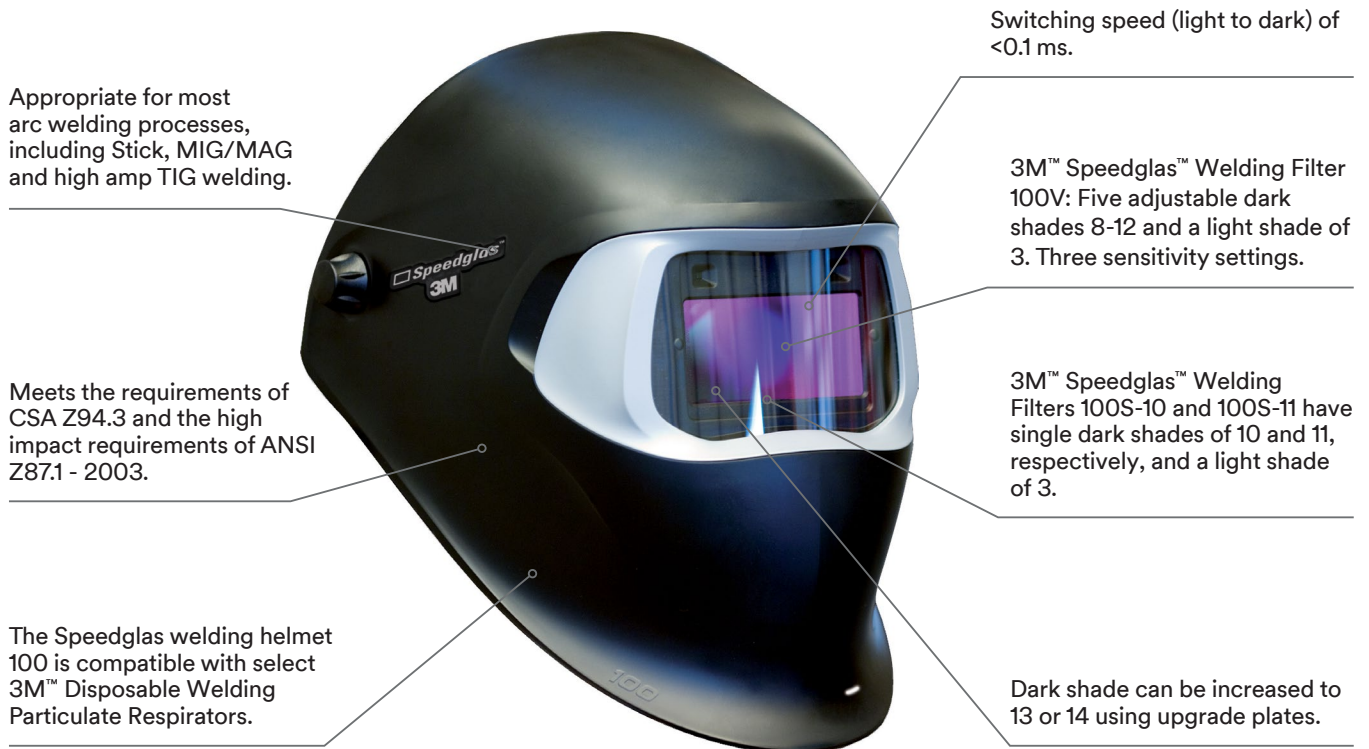

Flexible head protection

The easy-to-use Speedglas welding helmet 100 is the ideal auto-darkening helmet for the occasional welder. We can now offer a new option for head protection with the 3M™ Speedglas™ Quick Release Welding Helmets (QR):

The rail swiftly clasps onto your hard hat via a releasable ratcheting mechanism. With the rail installed, you can easily detach the welding visor so your hard hat remains in place for non-welding tasks. No more wearing a welding helmet when you do not need it.



3M™ Speedglas™ Welding Helmet 100-QR



Image
is Everything

3M™ Speedglas™ Graphic Welding Helmets Series 100

Speedglas welding helmet series 100 delivers impressive protection and performance with distinctive graphic designs — all with a specific identity.

Styles are refreshed often, contact your 3M representative to learn about the latest styles.



Tribute
07-0012-31TB



Boneyard
07-0012-31BY



Ice Hot
07-0012-31IH



Xterminator
07-0012-31XT



Raging Skull
07-0012-31RS



Razor Dragon
07-0012-31RD



Trojan Warrior
07-0012-31TW



Blazed
07-0012-31BZ



Aces High
07-0012-31AH



Future Combatant
07-0012-31FC

Female Graphic Edition

Inspired by women welders, 3M launched the first line of women specific designs. Our design team took direct inspiration from women welders to work with intricate patterns and graphics. The resulting designs are an avenue for personal expression.



Steel Rose
07-0012-31SE

Toughness and patinated grace. Strong, fearless, and feminine at the same time. Steel aesthetics emphasize the protective qualities of the helmet.



Wild-N-Pink
07-0012-31WP

Pretty in pink, but do not touch! A vivacious vine flourishes behind a protective overlay of barbed wire and razor-sharp metal sculpture. Admire from a distance.



Skull Jewels
07-0012-31SJ

An elaborate floral grill motif emerges into a decorative skull and covers the entire helmet. The skull and flowers engage in visual interplay as one becomes the other, and viceversa.



Steel Eyes
07-0012-31SE

Projecting inner strength, with focused eyes looking through a blaze of lilac flames.

Made with Your Safety in Mind

Benefit from the superior optical performance of a Speedglas auto-darkening welding filter as well as the added safety of an L-series hard hat and the comfort of continuous airflow. Whether welding or grinding, our products may help you stay more comfortable and productive.

- Positive pressure airflow reduces breathing resistance and helps provide respiratory protection without the need for a tight face seal. No fit testing required.
- Wideview faceshield allows for excellent peripheral and downward vision.
- Can be worn with limited facial hair, prescription eyewear or safety glasses. (Do not wear if facial hair comes between the face and respirator face seal.)
- Select from a passive welding filter or from 3M™ Speedglas™ Welding Filter Series 9100 with superior optical performance for continuous viewing comfort.
- 3M™ Speedglas™ Fresh-air III Supplied Air System allows workers to regulate the airflow, as well as cool or heat the air entering the headgear — ideal for extreme temperature working environments.
- For full mobility, combine with our 3M™ Adflo™ Powered Air Purifying Respirator and HE particulate filter.



3M™ Speedglas™ Headgear L-Series SG for Powered or Supplied Air Protection



3M™ Headgear L-705 SG
Hard hat with welding shield and wideview faceshield.



3M™ Headgear L-905 SG
Welding helmet with welding shield and wideview faceshield.



“It’s Like My Own
Private Oasis”

Cooler, cleaner and more comfortable welding

The Adflo powered air purifying respirator is specially designed to meet your welding needs. It helps provide continuous filtered air to the wearer. By using the Adflo PAPR, you can get both increased protection over certain respirators and comfort for extended wear.

Full mobility

The slim profile and ergonomic design make it easier to go into tight welding spaces and offer the quality and functions you should expect from a robust and easy-to-use PAPR system. The new Li-ion battery makes it even more lightweight and balanced for even greater comfort during a full shift.

An adaptable system that saves money

With the HE filter and OV/AG cartridge, the Adflo PAPR can help protect you against both particles and certain gases and vapors – all in one system. And you can selectively replace either the particle filter or the OV/AG cartridge as needed: you don't need to change both the filter and cartridge at the same time.



Constant flow of clean air

The Adflo PAPR is designed to provide airflow which is at a constant nominal rate of approximately 7.2 CFM (205 liters per minute), regardless of the battery's charge or the particle loading of the filter.

Higher altitudes



For welders working in higher altitude locations where the standard Adflo PAPR might not work properly, there is a special version that adjusts for changes in air density: 3M™ Adflo™ Turbo Assembly with High Altitude Compensation. With this version, you can work at altitudes up to approx. 10,000 ft (3000 MASL) with the HE filter and up to approx. 5,000 ft (1500 MASL) when using the OV/AG cartridge.



- A Filter cover:** holds the different available Adflo filters
- B Spark arrestor.**
- C Prefilter:** designed to increase the service life of the particle filter.
- D HE particle filter:** high efficiency particulate filtration.
- E OV/AG cartridge:** OV/AG cartridge captures certain organic vapors and acid gases. OV/AG cartridges are sold separately.
- F Odor filter:** removes unpleasant smells (not needed if the OV/AG cartridge is installed); sold separately.
- G Li-ion battery:** fully charges in 4,5 hours. Expected operating time is 7-9 hours with new particle filter, new fully-charged battery and a standard airflow.
- H Brushless motor:** with up to three times the life of conventional motors.
- I Filter/Battery Indicator:** indicates the status of the particle filter.
- J Breathing tube:** different options available
- K Exclusive airflow pattern:** evenly distributes filtered air throughout the entire breathing zone of the helmet. The intelligent turbo unit keeps the airflow rate at a constant, preset level. A diffuser spreads out the airflow pattern for your maximum comfort.
- L Soft, flexible face seal (removed here for clarity):** creates a positive pressure environment within the helmet, keeping the surrounding pollutants at bay.

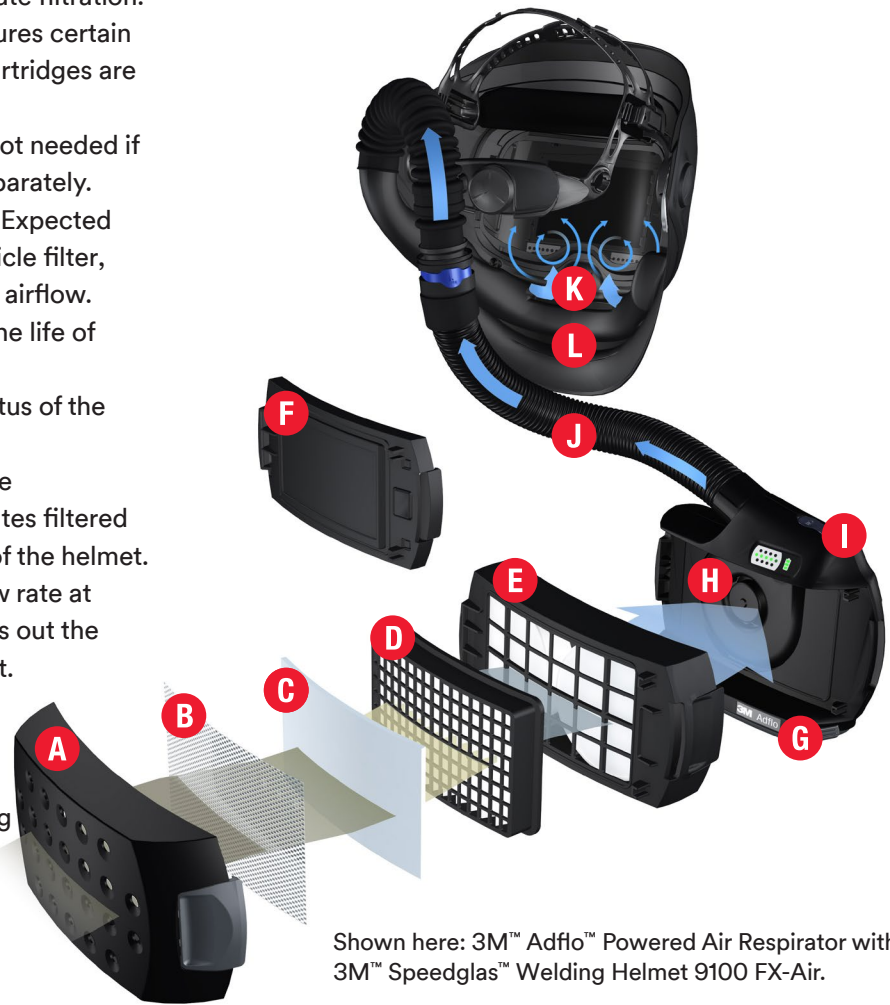

Shown here: 3M™ Adflo™ Powered Air Respirator with 3M™ Speedglas™ Welding Helmet 9100 FX-Air.



3M™ Adflo™ Battery Charging Stand

The new 6-position battery charging stand for Adflo batteries provides the ability to charge six batteries at the same time. Saving both time and hassle. Compatible with legacy NiMH batteries and the new Li-ion batteries. Flexible installation: either mount on wall or stand-alone.

Part No 35-0099-08N6 able to organize and hold your chargers for up to 6 batteries.

3M™ Speedglas™ Welding Helmet 9100-Air with 3M™ Adflo™ PAPR

Welding helmet with auto-darkening filter. Ergonomic welder protection with optimal mobility and ease-of-use.



35-1101-30SW

Speedglas welding helmet 9100-Air with Adflo PAPR with HE filter:

- 35-1101-00SW system without welding filter
- 35-1101-00SWHA high altitude system without welding filter
- 35-1101-10SW system with Speedglas welding filter 9100V.
- 35-1101-20SW system with Speedglas welding filter 9100X.
- 35-1101-30SW system with Speedglas welding filter 9100XX.
- 35-1101-30iSW system with Speedglas welding filter 9100XXi.

Speedglas welding helmet 9100-Air and Adflo PAPR with HE filter and OV/SD/CL/HC cartridge:

- 35-3301-10SW system with Speedglas welding filter 9100V.
- 35-3301-20SW system with Speedglas welding filter 9100X.
- 35-3301-30SW system with Speedglas welding filter 9100XX.

3M™ Speedglas™ Welding Helmet 9100 FX-Air with 3M™ Adflo™ PAPR

Welding helmet with auto-darkening welding filter and an approx. 8 in. x 4.25 in. clear visor for weld preparations. Excellent for low-light conditions and eye, face and respiratory protection.



36-1101-30SW

Speedglas welding helmet 9100 FX-Air with Adflo PAPR with HE filter:

- 36-1101-00SW system without welding filter
- 36-1101-00SWHA high altitude system without welding filter
- 36-1101-10SW system with Speedglas welding filter 9100V.
- 36-1101-20SW system with Speedglas welding filter 9100X.
- 36-1101-30SW system with Speedglas welding filter 9100XX.

Speedglas welding helmet 9100 FX-Air and Adflo PAPR with HE filter and OV/SD/CL/HC cartridge:

- 36-3301-00SW system without welding filter
- 36-3301-10SW system with Speedglas welding filter 9100V.
- 36-3301-20SW system with Speedglas welding filter 9100X.
- 36-3301-30SW system with Speedglas welding filter 9100XX.

3M™ Speedglas™ Welding Helmet 9100 MP with 3M™ Adflo™ PAPR

Welding helmet with hard hat, auto-darkening welding filter and an approx. 8 in. x 4.25 in. clear visor for weld preparations. Up to five levels of welder protection: head, eye, face, respiratory and optional hearing combined into one system.



37-1101-20SW

Speedglas welding helmet 9100 MP with Adflo PAPR with HE filter:

- 37-1101-00SW system without welding filter
- 37-1101-00SWHA high altitude system without welding filter
- 37-1101-10SW system with Speedglas welding filter 9100V.
- 37-1101-20SW system with Speedglas welding filter 9100X.
- 37-1101-30SW system with Speedglas welding filter 9100XX.



Lightweight System Delivers Maximum Airflows

For welding environments where supplied air respiratory protection is needed, the 3M™ Speedglas™ Fresh-air III Supplied Air Regulator System, can be used with the 3M™ Speedglas™ Welding Helmets 9100-Air, 9100 FX-Air and 9100 MP. The lightweight, belt-mounted regulator allows you to regulate the airflow from a supplied air source and cool or heat the air entering the headgear by as much as 50°F (28°C), – ideal for extreme temperature work environments.



Quick Connections

The belt-mounted regulator connects to an approved air hose with a quick release connector system. Oil mist, water vapor, or non-toxic, unpleasant odors in the air supply can be removed with an air filter regulator panel, such as 3M™ Filter and Regulator Panel W-2806 or 256-02-00.

Respirator Standards

The Speedglas Fresh-air III supplied air regulator system meets National Institute for Occupational Safety and Health (NIOSH) standards for supplied air respirators, OSHA assigned protection factor of 25 with Speedglas welding helmets 9100-Air/9100 FX-Air/9100 MP, and Fresh-air III SAR regulator (3M™ Valves V-Series). Meets the requirements of CSA Z94.3 for CSA marked products and the high impact requirements of ANSI Z87.

Available Supplied Air Hoses and Panels	3M™ Supplied Air Hoses		3M™ Filter and Regulator Panels	
				
Part Numbers	W-9425-25 (25 ft) W-9435-50 (50 ft) W-9435-100 (100 ft)	W-2929-25 (25 ft) W-2929-50 (50 ft) W-2929-100 (100 ft)	W-2806 Filter and Regulator Panel, 50 cfm W-2808 CO Monitor Retrofit Kit	256-02-00 Portable Filter and Regulator Panel, 50 cfm
Applications	3/8 in High Pressure Hose (25, 50, or 100 ft)		Helps to remove water, oil, particles, odors and vapors	Removes limited amounts of carbon monoxide and other contaminants without using large desiccant drying towers

3M™ Speedglas™ Welding Helmet 9100-Air with 3M™ Speedglas™ Fresh-air III Supplied Air Regulator (SAR)

Welding helmet with auto-darkening welding filter combined with NIOSH-approved supplied air respirator system.



Speedglas welding helmet 9100-Air with Fresh-air III SAR and V-100 cooling valve:

25-5702-10SW with Speedglas welding filter 9100V.
25-5702-20SW with Speedglas welding filter 9100X.
25-5702-30SW with Speedglas welding filter 9100XX
25-5702-30iSW with Speedglas welding filter 9100XXi

Speedglas welding helmet 9100-Air with Fresh-air III SAR and V-200 heating valve:

25-5802-10SW with Speedglas welding filter 9100V.
25-5802-20SW with Speedglas welding filter 9100X.
25-5802-30SW with Speedglas welding filter 9100XX.

3M™ Speedglas™ Welding Helmet 9100 FX-Air with 3M™ Speedglas™ Fresh-air III Supplied Air Regulator (SAR)

Welding helmet with hard hat, auto-darkening welding filter and an approx. 8 in. x 4.25 in. clear visor for weld preparations. Excellent for low-light conditions and eye, face and respiratory protection.



Speedglas welding helmet 9100 FX-Air with Fresh-air III SAR and V-100 cooling valve:

26-5702-10SW with Speedglas welding filter 9100V.
26-5702-20SW with Speedglas welding filter 9100X.
26-5702-30SW with Speedglas welding filter 9100XX.

Speedglas welding helmet 9100 FX-Air with Fresh-air III SAR and V-200 heating valve:

26-5802-10SW with Speedglas welding filter 9100V.
26-5802-20SW with Speedglas welding filter 9100X.
26-5802-30SW with Speedglas welding filter 9100XX.

3M™ Speedglas™ Welding Helmet 9100 MP with 3M™ Speedglas™ Fresh-air III Supplied Air Regulator (SAR)

Welding helmet with hard hat, auto-darkening welding filter and an approx. 8 in. x 4.25 in. clear visor for weld preparations. Five levels of welder protection: head, eye, face, respiratory and optional hearing combined into one system.



Speedglas welding helmet 9100 MP with Fresh-air III SAR and V-100 cooling valve:

27-5702-00SW system without welding filter
27-5702-10SW with Speedglas welding filter 9100V.
27-5702-20SW with Speedglas welding filter 9100X.
27-5702-30SW with Speedglas welding filter 9100XX.

Speedglas welding helmet 9100 MP with Fresh-air III SAR and V-300 air-regulating valve:

27-5902-10SW with Speedglas welding filter 9100V.
27-5902-20SW with Speedglas welding filter 9100X.
27-5902-30SW with Speedglas welding filter 9100XX.

Highly versatile rigid headtops

The 3M™ Versaflo™ Headtops M-series feature light-weight, compact and well-balanced faceshields and helmets that can offer integrated protection from a range of respiratory, head, eye and hearing hazards, with optional offerings for neck and shoulder coverage.

The Versaflo helmet M-307 (pictured below) and faceshield M-107 can be used in combination with 3M™ Adflo™ Powered Air Respirator or 3M™ Versaflo™ Supplied Air Regulator V-500.

Fully-adjustable suspension that includes textile straps for optimal fit and weight distribution.

Optional accessories include earmuffs, peel-off s, head covers and a chin strap. Spare parts and accessories are quick and easy to replace; for example, visors easily slide into place and are secured by quickly snapping two buttons.



A deflector allows users to direct the airflow inside the headtop for increased control and comfort.

The visor design combines excellent peripheral and downward vision with good optical clarity. Coated visors provide added chemical and scratch resistance.

To suit a wide range of needs, industries and applications, Versaflo M-Series headtops offer face seals and shrouds in various fabrics.

Excellent airflow

3M™ Versaflo™ M-Series Headtops direct a comfortable stream of flowing air to where workers need it most: the head and face. The moving airflow can make hot environments more tolerable while greatly reducing visor fogging.



3M™ Versaflo™ Faceshield M-107

Lightweight, compact and well-balanced faceshield offers integrated protection from a range of eye, face and hearing hazards. Features a flame-retardant faceseal for protection against hot particles.



Part no:

M-107 Versaflo faceshield M-107
35-5401-01 3M™ Adflo™ Powered Air Respirator*

3M™ Versaflo™ Bumpcap M-207

Lightweight, compact and well-balanced faceshield offers integrated protection from a range of eye, face and hearing hazards. Features a flame-retardant faceseal for protection against hot particles.



Part no:

M-207 Versaflo faceshield M-207
35-5401-01 3M™ Adflo™ Powered Air Respirator*

3M™ Versaflo™ Helmet M-307

Features a flame-retardant faceseal for protection against hot particles. Fabric material: Polyester. Head protection approved according to ANSI Z89.1-2009 requirements for Type 1 Class G hard hats.



Part no:

M-307 Versaflo helmet M-307
35-5401-01 3M™ Adflo™ Powered Air Respirator*

3M™ Versaflo™ Helmet with Shroud M-407

Features a flame-retardant shroud for protection against hot particles. Fabric material: Polyaramid. Head protection approved according to ANSI Z89.1-2009 requirements for Type 1 Class G hard hats. In the U.S. its for use with Adflo system. Use with SG-50W breathing tube that is foam lined.



Part no:

M-407 Versaflo helmet M-407 with shroud.
35-5401-01 3M™ Adflo™ Powered Air Respirator

Frequently Asked Questions about Hexavalent Chromium and Manganese

Hexavalent Chromium (CrVI) is a form of the metal chromium that rarely occurs naturally and is most commonly produced by industrial processes. Hexavalent chromium fume is generated when performing “hot work” such as welding on stainless steel or other alloys containing chrome.

As chrome-containing welding fume forms, it oxidizes into trivalent or hexavalent species. The hexavalent form is far more toxic than the metallic or hexavalent forms. Hexavalent Chromium is often referred to as Hex Chrom, Hex Chrome, Chromium 6, Hexa Chrom, Cr(VI), or HexChrome.

Manganese is a grey-white metal resembling iron. Manganese is used extensively in steel and other metal alloys to promote hardness and reduce cracking. Most steel welding electrodes also contain manganese. Unlike hexavalent chrome, all species of manganese oxide welding fume are presumed to be of equal toxicity.

Overexposure to manganese fume has been linked to a neurological disorder that resembles Parkinson’s Disease. Symptoms may include weakness/lethargy, speech and psychological disturbances, paralysis, and tremors.

To help reduce the risk of adverse health effects caused by exposures to airborne materials such as Cr(VI) and manganese, the United States Occupational Safety and Health Administration (OSHA) has established permissible exposure limits (PELs). In addition, the American Conference of Governmental Industrial Hygienists (ACGIH) sets threshold limit values (TLVs®) which are exposure guidelines.

Watch our webinar on YouTube/3MSpeedglas!



Standards, Regulations and Enforcement Cr(VI)

On February 28th, 2006 (OSHA) published the final Hexavalent Chromium (CrVI) Standard. There are three versions of the standard: General Industry (1910.1026), Construction (1910.1126), and Shipyards (1515.1026). The requirements of each standard are very similar. The OSHA PEL for all industries is 5 micrograms per cubic meter of air ($5 \mu\text{g}/\text{m}^3$), reduced from $52 \mu\text{g}/\text{m}^3$. The PEL is a time weighted average (TWA) for an 8-hour workday and 40-hour workweek. The action level, or the level where many of the requirements of the standard such as medical surveillance may be required, is $2.5 \mu\text{g}/\text{m}^3$.

A copy of this instructional manual can be found at: www.osha.gov/OshDoc/Directive_pdf/CPL_02-02-076.pdf

Manganese

The current OSHA PEL for manganese is 5 milligrams per cubic meter of air ($5 \text{mg}/\text{m}^3$). This PEL is based on a “total” particle size sampling method which includes particles much larger than those produced by welding processes. OSHA has had the same exposure limit for manganese since 1971. The ACGIH TLV for manganese is an 8-hour TWA limit of $0.02 \text{mg}/\text{m}^3$ respirable size fraction and $0.1 \text{mg}/\text{m}^3$ for the inhalable size fraction. The respirable fraction is the smallest size fraction (10 microns and smaller) a relevant category for fume particles.



Respiratory Protection for Cr(VI) and Manganese Exposure

In many cases, changes in manufacturing processes and engineering controls alone can't reduce exposure levels to below the occupational exposure limits (OELs). In such cases, it may be appropriate to use respiratory protection.

For any particular application, an array of respirator types that provide an appropriate level of protection are available. The cost of these respirators may vary from around \$1 for a basic negative-pressure, disposable, filtering facepiece to \$2,000 or more for a powered or supplied-air system.

Respirators should be selected based on results from air sampling and the necessary assigned protection factor (APF) as established within OSHA 29 CFR 1910.134. OSHA requires employers to implement a written respiratory protection program when respiratory protection is used. Elements of the written program include respirator selection, use, care and maintenance, medical evaluation, training, and fit testing.

Summary

Cr(VI) and Manganese are found in many manufacturing processes. As a precaution, review MSDS sheets for materials containing these substances in manufacturing processes. If there are questions regarding the air quality, it may be a good idea to discuss the option of air sampling with an industrial hygienist to better determine the levels of contaminants within a given process.

If the air sampling results indicate exposure levels above the occupational exposure limit (either PEL or TLV, whichever the employer is using), changes to manufacturing processes, use of other engineering controls or PPE may be suitable choices to reduce employee exposures to acceptable levels.

Further questions regarding this article or selection of respiratory protection may be directed to 3M PSD Technical Service at

1-800-243-4630

Recommended guide for shade numbers according to ANSI Z49.1 -2012

Welding process	Current in amperes A																									
	1.5	6	10	20	30	40	60	70	100	125	150	175	200	225	250	300	350	400	450	500	600	700	800	900	1000	
Shielded Metal Arc									10				12			14										
Gas Metal Arc Welding									11				12			14										
Gas Tungsten Arc Welding						10			12						14											
Air Carbon Arc Cutting																										14
Plasma Arc Welding			6-8			10									12											14
Plasma Arc Cutting																										14
Carbon Arc Welding																										14

The table recommends best dark shade of welding filter for various working applications. According to the conditions of use, the next greater or the next smaller scale number can be used.

Transmittance (%)

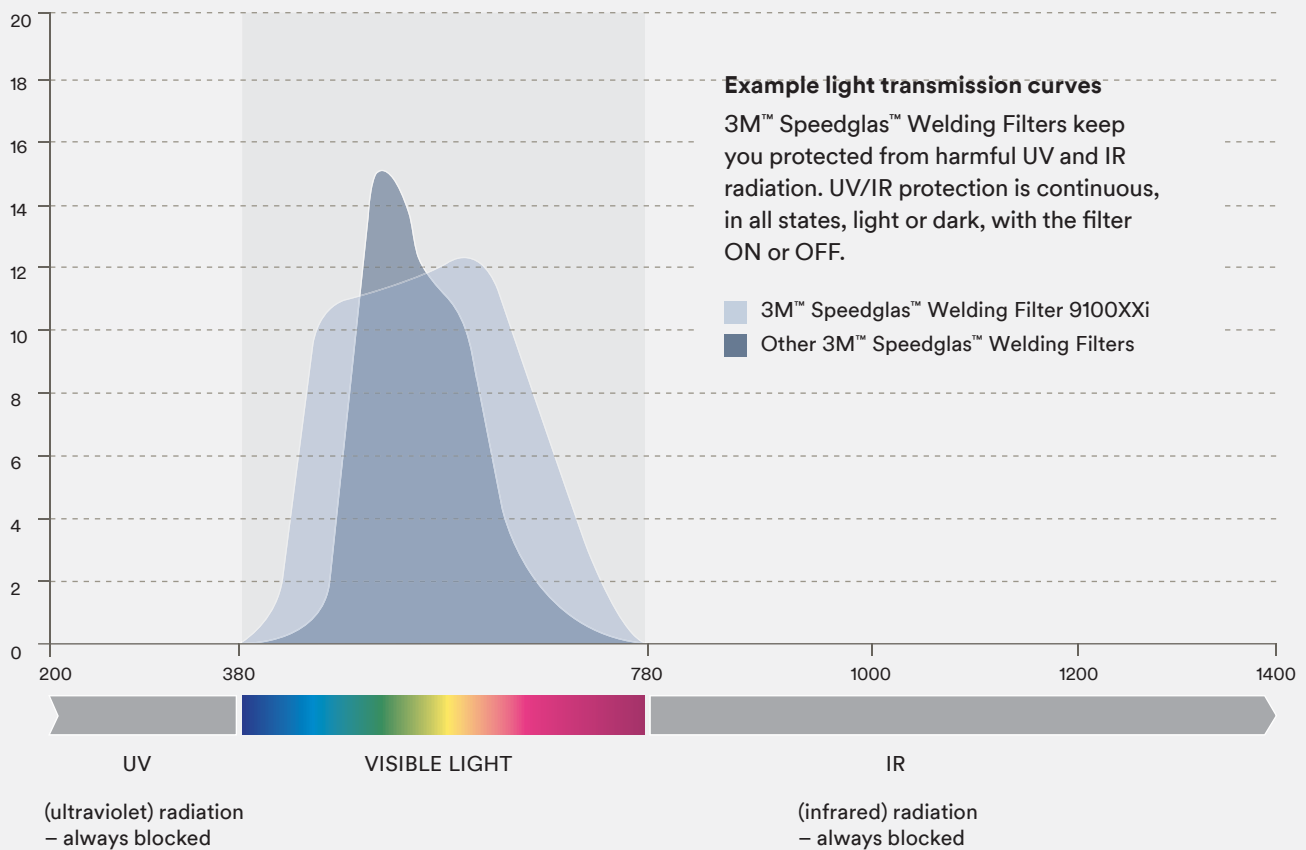

Parts directory

3M™ Speedglas™ Welding Helmets (non-respiratory models)	
Speedglas Welding Helmet 9100	45
Speedglas Welding Helmet 9100 FX	46
Speedglas Welding Helmet 9100-QR	47
Speedglas Welding Filter Adapter 9100 for Passive Lens	48
Speedglas Welding Helmet SL	48
Speedglas Welding Helmet Series 100	49
Speedglas Welding Helmet Series 100-QR	50
Speedglas Welding Helmet Adapter for	
Speedglas Welding Helmets 9100 / 9100 FX / 100	50
Speedglas Welding Helmet 9000/FlexView/ProTop/Utility	51
<hr/>	
3M™ Speedglas™ Respiratory Protection	
Adflo Powered Air Respirator	53
Speedglas Fresh-air III Supplied Air Regulator	54
<hr/>	
3M™ Headtops for Respiratory Protection	
Speedglas Welding Helmet 9100-Air	55
Speedglas Welding Helmet 9100 FX-Air	56
Speedglas Welding Helmet 9100 MP	57
Versaflo Headtops M-series	58
Care and maintenance	63
Technical Specifications	64–66
Product index	67





Easy upgrade to the latest helmet systems!

Still using an older welding system? Did you know you can easily upgrade your current 3M™ Adflo™ Powered Air Respirator System with one of our new premium welding helmets, without buying a new respirator? Below you will find a list of various upgrade kits within our top-of-the-line 3M™ Speedglas™ Welding Helmet Series 9100. These welding helmets feature the QRS type of breathing tube (Quick Release Swivel), which enables one-handed connection and release. To protect your new helmet system from scratches, we include a special Speedglas bag for free when ordering any of the upgrade kits.



SPECIAL SPEEDGLAS BAG INCLUDED!



Part No – all with welding helmet, breathing tube and carry bag:

36-1101-00SW	Speedglas welding helmet 9100 FX-Air, without welding filter
36-1101-10SW	Speedglas welding helmet 9100 FX-Air, with 9100V filter
36-1101-20SW	Speedglas welding helmet 9100 FX-Air, with 9100X filter
36-1101-30SW	Speedglas welding helmet 9100 FX-Air, with 9100XX filter
35-1101-00SW	Speedglas welding helmet 9100-Air, without welding filter
35-1101-10SW	Speedglas welding helmet 9100-Air, with 9100V filter
35-1101-20SW	Speedglas welding helmet 9100-Air, with 9100X filter
35-1101-30SW	Speedglas welding helmet 9100-Air, with 9100XX filter
35-1101-30iSW	Speedglas welding helmet 9100-Air, with 9100XXi filter
37-1101-00SW	Speedglas welding helmet 9100MP, without welding filter
37-1101-10SW	Speedglas welding helmet 9100MP, with 9100V filter
37-1101-20SW	Speedglas welding helmet 9100MP, with 9100X filter
37-1101-30SW	Speedglas welding helmet 9100MP, with 9100XX filter

Revitalize your welding respirator!

If you are using an older 3M™ Adflo™ Powered Air Respirator, you can easily upgrade to a new level of performance, incorporating a Li-ion battery, making the turbo almost 20% lighter in weight. As a special offer we include a free set of both particle filter and pre-filters. Regular replacement of the pre-filter extends the life of the particle filter, saving money while also increasing the battery run-time.

Read more about the new Adflo respirator on **page 24** or visit www.3M.com/workersafety



Part no Adflo upgrade kit:

35-1099-17 Li-ion standard battery pack with charger, particle filter and set of pre-filters.



3M™ Speedglas™ Welding Filter Kit 9100XXi

Your window to a new world of more realistic color and detail – to help you weld, grind and see your finish. Keep compatible with Speedglas welding helmets 9100, 9100-Air and 9100-QR.

Learn more about the new Speedglas welding filter on 3M.com/speedglasxxi



Part No:

06-0000-30i-KIT Welding filter 9100XXi with new silver front

Head and hearing protection

The 3M™ Speedglas™ Quick Release (QR) Rail allows you to attach a Speedglas auto-darkening welding helmet to many of the industry's most popular hard hats. 3M offers a complete welding helmet system including the 3M™ Hard hat H-701. The H-701 is a full-featured hard hat capable of accepting 3M integrated eyewear and earmuffs in addition to the 3M™ Speedglas™ Welding Helmet 9100-QR.

Internal slots for accessory earmuffs.

Ventilated headband for improved comfort.

Smooth ratchet for precision headband adjustment.

Short brim and compact design for increased user mobility and visibility.



3M™ PELTOR™ Earmuffs X-Series

PELTOR™

Featured accessory to 3M™ Speedglas™ Welding Helmet 9100 MP and other Speedglas welding helmets combined with 3M™ Hard hats.

- New ear cushion foam technology for an effective acoustic seal and reliable protection
- Streamlined cups without compromising attenuation
- Lightweight dual mold cups with maximum space inside to help minimize heat and moisture build-up
- Integrated design for more robustness
- Color-coded for ease of selection
- Easy to clean



3M™ PELTOR™
Earmuffs X1
NRR: 21dB*



3M™ PELTOR™
Earmuffs X2
NRR: 24dB*



3M™ PELTOR™
Earmuffs X3
NRR: 25dB*

























3M™ PELTOR™
Earmuffs X4
NRR: 25dB*











3M™ PELTOR™
Earmuffs X5
NRR: 31dB*

* For further attenuation information please visit www.3M.com/workersafety

3M™ Speedglas™ Welding Helmets – sorted by features

	3M™ Speedglas™ Welding Helmet 9100									
	3M™ Speedglas™ Welding Helmet 9100-Air									
	3M™ Speedglas™ Welding Helmet 9100-QR									
	3M™ Speedglas™ Welding Helmet 9100 FX									
	3M™ Speedglas™ Welding Helmet 9100 FX-Air									
	3M™ Speedglas™ Welding Helmet 9100 FX (with hard hat)									
	3M™ Speedglas™ Welding Helmet 9100 MP									
	3M™ Speedglas™ Welding Helmet SL									
	3M™ Speedglas™ Welding Helmet 100									
	3M™ Speedglas™ Welding Helmet 100-QR									

-  Eye & face protection
-  Side windows
-  Hearing protection**
-  Exhaust vents
-  Respiratory system
-  Graphics option
-  Head protection
-  Auto-on
-  Flip-up

* Only in combination with 3M™ Speedglas™ Welding Filter 9100XXi ** 3M™ PELTOR™ Hearing Protection available as accessories, see each welding helmet parts list.

3M™ Speedglas™ Welding Helmet 9100



Part No	Description	Part No	Description	Part No	Description
06-0100-10	Speedglas welding helmet 9100 with welding filter 9100V	06-0100-20	Speedglas welding helmet 9100 with welding filter 9100X	06-0100-30HASW	Speedglas welding helmet 9100, with side windows, hard hat adapter and welding filter 9100XX, without hard hat
06-0100-10HASW	Speedglas welding helmet 9100, with side windows, hard hat adapter and welding filter 9100V, without hard hat	06-0100-20HASW	Speedglas welding helmet 9100, with side windows, hard hat adapter and welding filter 9100X, without hard hat	06-0100-30HHSW	Speedglas welding helmet 9100 with side windows, hard hat and welding filter 9100XX
06-0100-10HHSW	Speedglas welding helmet 9100 with side windows, hard hat and welding filter 9100V	06-0100-20SW	Speedglas welding helmet 9100 with side windows and welding filter 9100X	06-0100-30SW	Speedglas welding helmet 9100 with side windows and welding filter 9100XX
06-0100-10SW	Speedglas welding helmet 9100 with side windows and welding filter 9100V	06-0100-30	Speedglas welding helmet 9100 with welding filter 9100XX	06-0100-30iSW	Speedglas welding helmet 9100 with side windows and welding filter kit 9100XXi

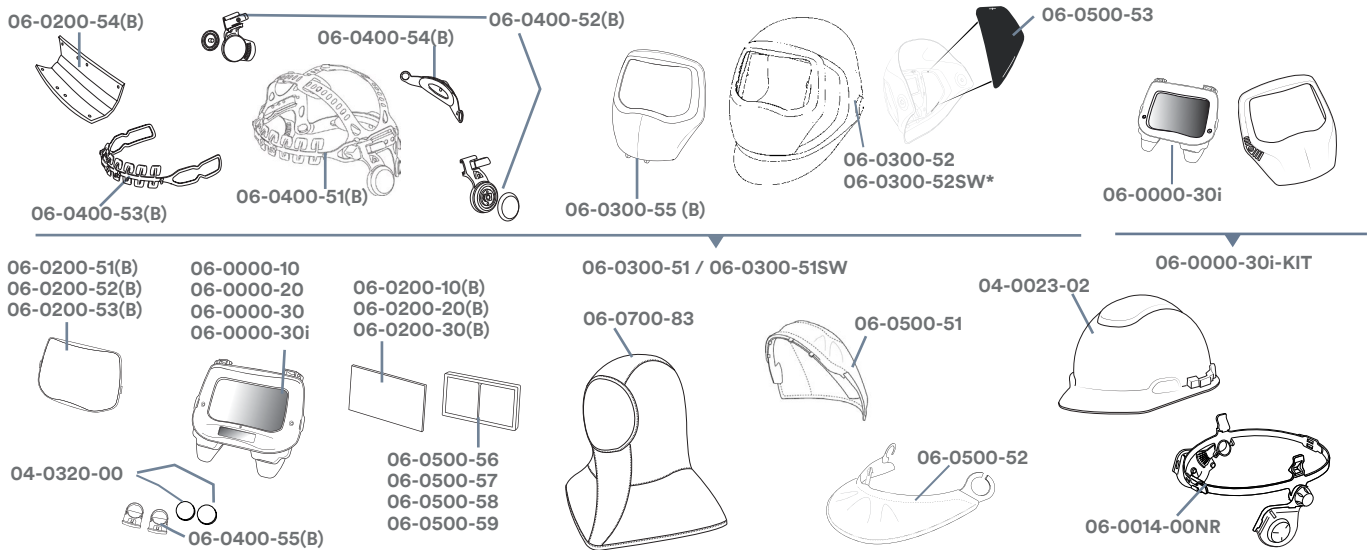

Accessories and consumables

Part No	Description	Part No	Description	Part No	Description
04-0023-02	Hard hat H-701, white	06-0200-53	Outside protection plate high temperature, 10/case	06-0300-55-B	Part no 06-0300-55, 5/case
04-0320-00	Batteries, 2/case	06-0200-53-B	Part no 06-0200-53, 50/case	06-0400-51	Headband incl assembled parts
06-0000-10	Speedglas welding filter 9100V	06-0200-54	Comfort sweatband, 3/case	06-0400-51-B	Part no 06-0400-51, 5/case
06-0000-20	Speedglas welding filter 9100X	06-0200-54-B	Comfort sweatband, 12/case	06-0400-52	Pivot mechanism headband, left and right
06-0000-30	Speedglas welding filter 9100XX	06-0201-10	Starter kit 9100V, incl 5 outside protection plates, 2 inside protection plates and 1 sweatband	06-0400-52-B	Part no 06-0400-52, 5/case
06-0000-30i	Speedglas welding filter 9100XXi	06-0201-20	Starter kit 9100X, incl 5 outside protection plates, 2 inside protection plates and 1 sweatband	06-0400-53	Headband front part
06-000030iKIT	Speedglas welding filter kit 9100XXi, (filter and silver front)	06-0201-30	Starter kit 9100XX, incl 5 outside protection plates and 1 sweatband	06-0400-53-B	Part no 06-0400-53, 5/case
06-0014-00NR	9100 hardhat adapter for with assembly parts, without hard hat	06-0300-51	Welding helmet without side windows, with headband and silver front panel	06-0400-54	Headband back part
06-0200-10	Inside protection plate 9100V, 5/case	06-0300-51SW	Welding helmet with side windows, headband and silver front panel	06-0400-54-B	Part no 06-0400-54, 5/case
06-0200-10-B	Part no 06-0200-10, 25/case	06-0300-52	Welding helmet without side windows, without headband	06-0400-55	Battery holder 9100, 2/case
06-0200-20	Inside protection plate 9100X, 5/case	06-030052SW*	Welding helmet with side windows, without headband	06-0400-55-B	Part no 06-0400-55, 10/case
06-0200-20-B	Part no 06-0200-20, 25/case	06-0300-55	Silver front panel 9100	06-0400-56	Extended coverage, Crown
06-0200-30	Inside protection plate 9100XX, 5/case			06-0500-51	Extended coverage, Crown
06-0200-30-B	Part no 06-0200-30, 25/case			06-0500-52	Extended coverage, Ear & Neck
06-0200-51	Outside protection plate standard, 10/case			06-0500-53	SideWindow cover plates, 2/case
06-0200-51-B	Part no 06-0200-51, 50/case			06-0500-56	Magnification plate 15x
06-0200-52	Outside protection plate scratch resistant, 10/case			06-0500-57	Magnification plate 20x
06-0200-52-B	Part no 06-0200-52, 50/case			06-0500-58	Magnification plate 25x
				06-0500-59	Magnification plate 30x
				06-0700-83	Full Hood, black/grey

3M™ Speedglas™ Welding Helmet 9100 FX



Part No	Description	Part No	Description	Part No	Description
06-0600-10SW	Speedglas welding helmet 9100 FX with welding filter 9100V	06-0600-10HHSW	Speedglas welding helmet 9100 FX with hard hat and welding filter 9100V	06-0600-30HHSW	Speedglas welding helmet 9100 FX with hard hat and welding filter 9100XX *
06-0600-20SW	Speedglas welding helmet 9100 FX with welding filter 9100X	06-0600-20HHSW	Speedglas welding helmet 9100 FX with hard hat and welding filter 9100X		
06-0600-30SW	Speedglas welding helmet 9100 FX with welding filter 9100XX				

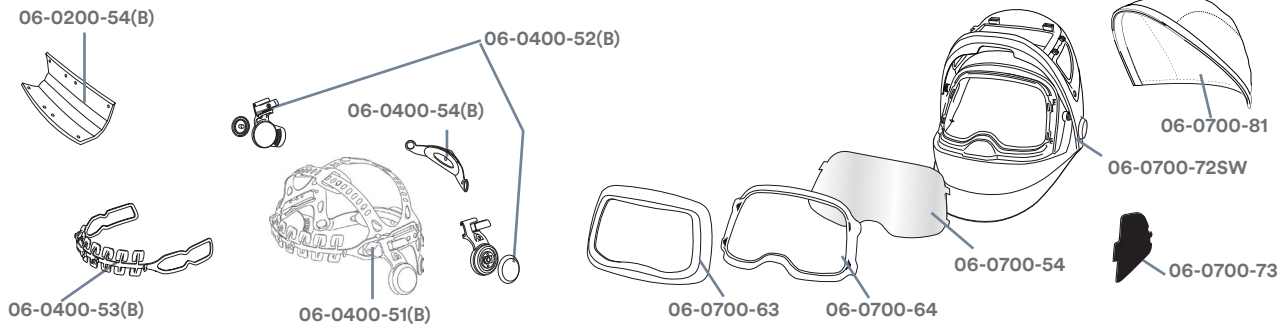

06-0600-00SW

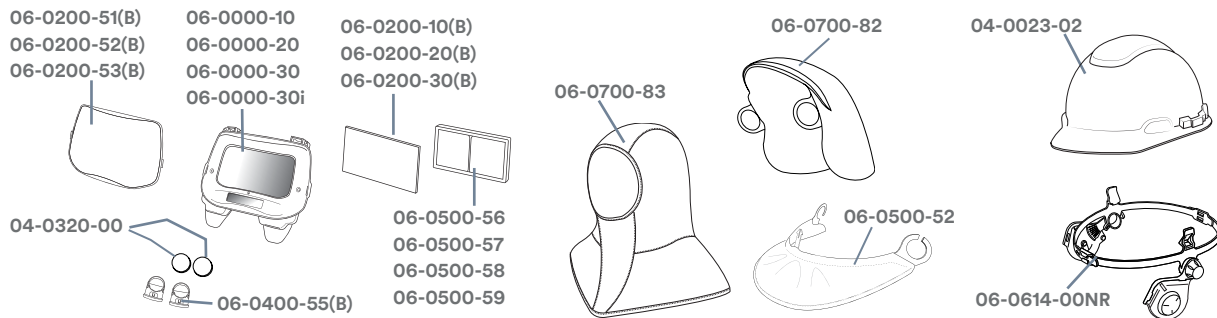

Accessories and consumables

Part No	Description	Part No	Description	Part No	Description
04-0023-02	Hard hat H-701R, white	06-0200-52-B	Part no 06-0200-52, 50/case	06-0600-00SW	Speedglas helmet 9100FX with side windows, without welding filter, with headband
04-0320-00	Batteries 2/case	06-0200-53	Outside protection plate high temperature, 10/case	06-0700-54	Wide-view clear grinding visor, anti-fog, 5/case
06-0000-10	Speedglas welding filter 9100V	06-0200-53-B	Part no 06-0200-53, 50/case	06-0700-63	Front panel, chrome
06-0000-20	Speedglas welding filter 9100X	06-0200-54	Comfort sweatband, 3/case	06-0700-64	Wide-view clear grinding visor frame, black
06-0000-30	Speedglas welding filter 9100XX	06-0200-54-B	Comfort sweatband, 12/case	06-0700-72SW	Welding helmet 9100FX with side windows, without headband, without welding filter
06-0000-30i	Speedglas welding filter 9100XXi	06-0400-51	Headband incl assembled parts	06-0700-73	SideWindow cover plates, 2/case
06-0014-00NR	Hard hat adapter for Speedglas welding helmet 9100 FX with assembly parts, without hard hat	06-0400-51-B	Part no 06-0400-51, 5/case	06-0700-81	Standard headcover, crown, black
06-0200-10	Inside protection plate 9100V, 5/case	06-0400-52	Pivot mechanism headband, left and right	06-0700-82	Extended headcover, head and neck
06-0200-10-B	Part no 06-0200-10, 25/case	06-0400-52-B	Part no 06-0400-52, 5/case	06-0700-83	Full Hood, black/grey
06-0200-20	Inside protection plate 9100X, 5/case	06-0400-53	Headband front part		
06-0200-20-B	Part no 06-0200-20, 25/case	06-0400-53-B	Part no 06-0400-53, 5/case		
06-0200-30	Inside protection plate 9100XX, 5/case	06-0400-54	Headband back part		
06-0200-30-B	Part no 06-0200-30, 25/case	06-0400-54-B	Part no 06-0400-54, 5/case		
06-0200-51	Outside protection plate standard, 10/case	06-0400-55	Battery holder 9100, 2/case		
06-0200-51-B	Part no 06-0200-51, 50/case	06-0400-55-B	Part no 06-0400-55, 10/case		
06-0200-52	Outside protection plate scratch resistant, 10/case	06-0500-52	Extended coverage, ear and neck		
		06-0500-56	Magnification plate 15x		
		06-0500-57	Magnification plate 20x		
		06-0500-58	Magnification plate 25x		
		06-0500-59	Magnification plate 30x		

3M™ Speedglas™ Welding Helmet 9100-QR



Part No	Description	Part No	Description	Part No	Description
06-0100-10QR	Speedglas welding helmet 9100-QR with 9100V welding filter and 3M Hard Hat H-701	06-0100-20QR	Speedglas welding helmet 9100-QR with 9100X welding filter and 3M Hard Hat H-701	06-0100-30QR	Speedglas welding helmet 9100-QR with 9100XX welding filter and 3M Hard Hat H-701

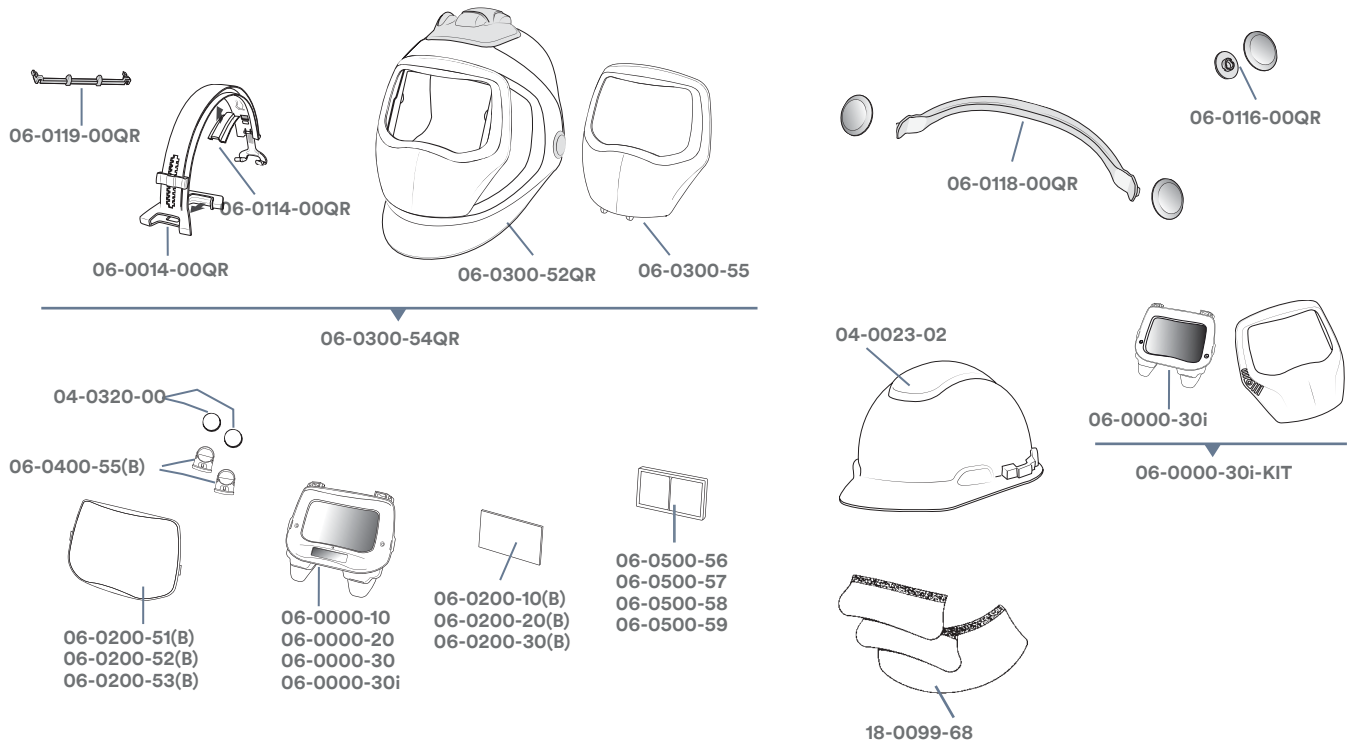

Accessories and consumables

Part No	Description	Part No	Description	Part No	Description
04-0023-02	3M hard hat H-701R, white (unvented)	06-0200-52-B	Part no 06-0200-52, 50/case	06-0300-54QR	Welding helmet 9100-QR with quick release rail, without welding filter, without hard hat
04-0320-00	Batteries 2/case	06-0200-53	Outside protection plate high temperature, 10/case	06-0300-55	Silver front panel 9100
06-0000-10	Speedglas welding filter 9100V	06-0200-53-B	Part no 06-0200-53, 50/case		
06-0000-20	Speedglas welding filter 9100X	06-0400-55	Battery holder 9100, 2/case		
06-0000-30	Speedglas welding filter 9100XX	06-0400-55-B	Part no 06-0400-55, 10/case		
06-0000-30i	Speedglas welding filter 9100XXi	06-0500-56	Magnification plate 15x		
06-0200-10	Inside protection plate 9100V, 5/case	06-0500-57	Magnification plate 20x		
06-0200-10-B	Part no 06-0200-10, 25/case	06-0500-58	Magnification plate 25x		
06-0200-20	Inside protection plate 9100X, 5/case	06-0500-59	Magnification plate 30x		
06-0200-20-B	Part no 06-0200-20, 25/case	18-0099-68	Ear and neck protection in leather		
06-0200-30	Inside protection plate 9100XX, 5/case	06-0014-00QR	Quick release rail for hard hat		
06-0200-30-B	Part no 06-0200-30, 25/case	06-0114-00QR	Rail retention parts		
06-0200-51	Outside protection plate standard, 10/case	06-0116-00QR	Pivot cover plate kit		
06-0200-51-B	Part no 06-0200-51, 50/case	06-0119-00QR	Distance bar when using welding filters 9100X/9100XX/9100XXi		
06-0200-52	Outside protection plate scratch resistant, 10/case	06-0118-00QR	Ear muff bar for Speedglas welding helmet 9100-QR		
		06-0300-52QR	Welding helmet 9100-QR without quick release rail, without welding filter, without hard hat		

3M™ Speedglas™ Welding Helmet Series 100/100-QR



Part No	Description	Part No	Description	Part No	Description
07-0012-10BL	Speedglas welding helmet 100 Black with welding filter 100S-10	07-0012-31BZ	Speedglas welding helmet 100 Blazed*	07-0012-31SJ	Speedglas welding helmet 100 Skull Jewels*
07-0012-11BL	Speedglas welding helmet 100 Black with welding filter 100S-11	07-0012-31FC	Speedglas welding helmet 100 Future Combatant*	07-0012-31SR	Speedglas welding helmet 100 Steel Rose*
07-0012-31AH	Speedglas welding helmet 100 Aces High*	07-0012-31IH	Speedglas welding helmet 100 Ice Hot*	07-0012-31TB	Speedglas welding helmet 100 Tribute*
07-0012-31BL	Speedglas welding helmet 100 Black*	07-0012-31RD	Speedglas welding helmet 100 Razor Dragon*	07-0012-31TW	Speedglas welding helmet 100 Trojan Warrior*
07-0012-31BLQR	Speedglas welding helmet 100-QR with 3M hard hat H-701*	07-0012-31RS	Speedglas welding helmet 100 Raging Skull*	07-0012-31WP	Speedglas welding helmet 100 Wild-N-Pink*
07-0012-31BY	Speedglas welding helmet 100 Boneyard*	07-0012-31SE	Speedglas welding helmet 100 Steel Eyes*	07-0012-31XT	Speedglas welding helmet 100 Xterminator*

* With Speedglas welding filter100V

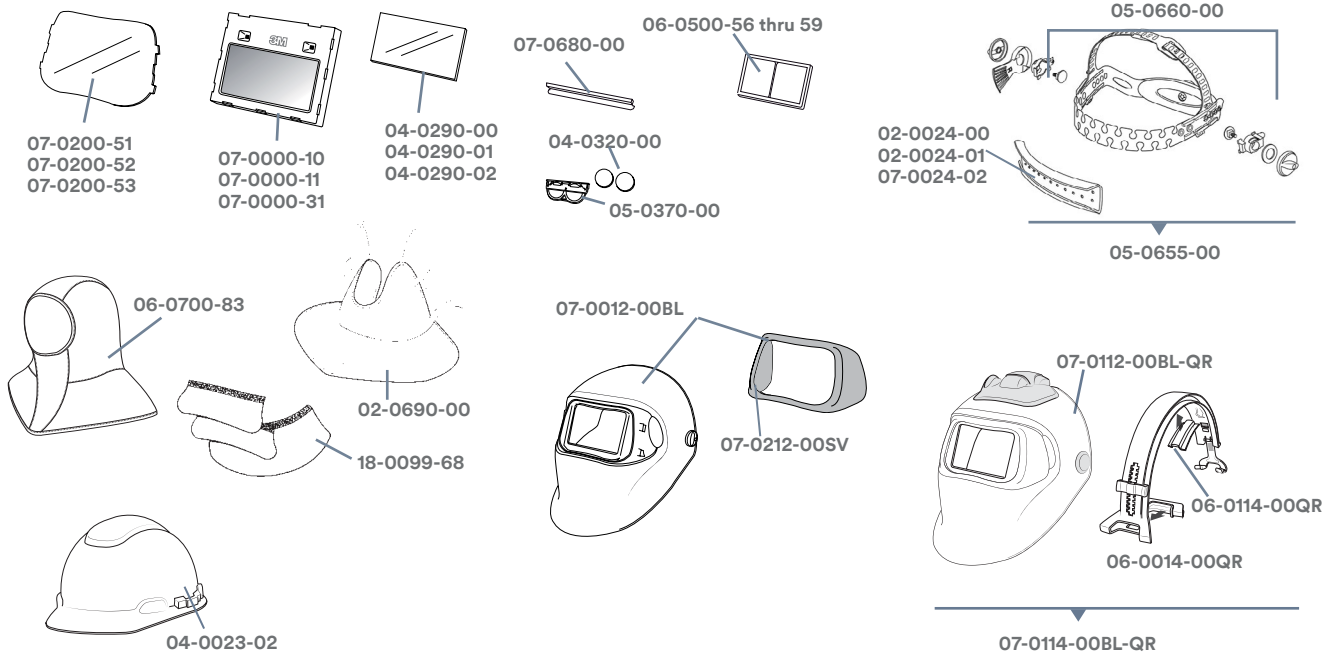

Accessories and consumables

Part No	Description	Part No	Description	Part No	Description
02-0024-00	Sweatband, cotton fleece with padding	06-0500-58	Magnification plate 25x	07-0200-53	Outside protection plate, high temperature, 10/case
02-0024-01	Sweatband, leather	06-0500-59	Magnification plate 30x	07-0212-00SV	Silver front frame 100
02-0690-00	Throat protection, black/grey	06-0700-83	Full hood, black/grey	07-0680-00	Holder for magnifier, 2/case
04-0023-02	3M hard hat H-701R (unvented)	07-0000-10	Speedglas welding filter 100S-10, shade 10	18-0099-68	Throat and side protector, leather
04-0290-00	Inside protection plate, 5/case	07-0000-11	Speedglas welding filter 100S-11, shade 11	06-0014-00QR	Quick release rail for hard hat
04-0290-01	Inside protection plate, +1 shade, 5/case	07-0000-31	Speedglas welding filter 100V, shade 8-12	06-0114-00QR	Rubber friction pads for quick release rail
04-0290-02	Inside protection plate, +2 shade, 5/case	07-0012-00BL	Welding helmet black, without welding filter, without headband	07-0112-00BL-QR	Welding helmet 100-QR without quick release rail, without welding filter, without hard hat
04-0320-00	Battery, 2/case	07-0024-02	Sweatband, fleece, 2/case	07-0114-00BL-QR	Welding helmet 100-QR with quick release rail, without welding filter, without hard hat
05-0370-00	Battery cover	07-0200-51	Outside protection plate, standard, 10/case		
05-0655-00	Comfort headband with assembly parts	07-0200-52	Outside protection plate, scratch resistant, 10/case		
05-0660-00	Assembly parts for headband				
06-0500-56	Magnification plate 15x				
06-0500-57	Magnification plate 20x				

3M™ Speedglas™ Welding Helmet SL



05-0013-41

Part No	Description	Part No	Description	Part No	Description
02-0024-00	Sweatband, cotton fleece with padding	05-0250-00	Outside protection plate, 5/ case	06-0500-57	Magnification plate 20x
02-0024-01	Sweatband, leather	05-0250-01	Outside protection plate, scratch resistant, 5/case	06-0500-58	Magnification plate 25x
02-0690-00	Throat protection black/grey	05-0370-00	Battery holder	06-0500-59	Magnification plate 30x
04-0290-00	Inside protection plate, 5/case	05-0655-00	Comfort headband with assembly parts	06-0700-83	Full hood, black/grey
04-0320-00	Battery, 2/case	05-0660-00	Assembly parts for headband	07-0024-02	Sweatband, fleece, black 2/ case
05-0000-41	Welding filter SL, shade 8-12	05-0680-00	Magnifying lens holder	16-0099-30	Headcover, FR Cotton
05-0013-00	Welding helmet, without headband	05-0695-00	Spatter protector	18-0099-68	Throat and side protector, leather
05-0013-41	Welding helmet SL with filter, variable shade 8-12	06-0500-56	Magnification plate 15x		

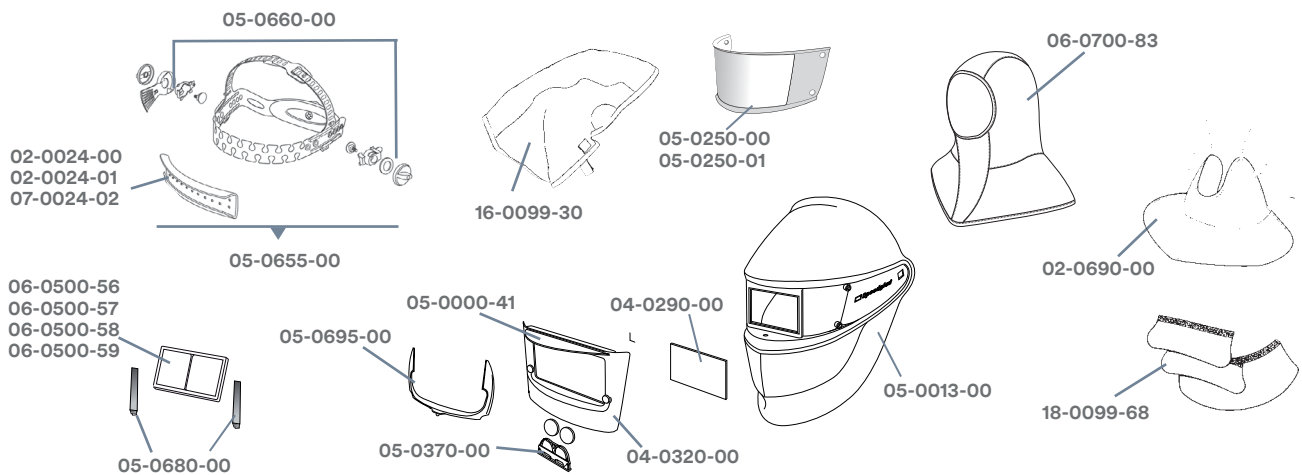

Speedyloop Hard Hat Options for 3M™ Speedglas™ Welding Helmets 9100 / 100



Part No	Description	Part No	Description	Part No	Description
04-0023-02	Hard hat, white	06-0100-20HASW	Speedglas welding helmet 9100 with side windows, hard hat adapter and welding filter 9100X, without hard hat	06-0100-30HHSW	Speedglas welding helmet 9100 with side windows, hard hat and welding filter 9100XX
06-0014-00NR	Hard hat adapter for Speedglas welding helmet 9100 with assembly parts, without hard hat	06-0100-20HHSW	Speedglas welding helmet 9100 with side windows, hard hat and welding filter 9100V, without hard hat	07-0012-31BL-HA	Speedglas welding helmet 100 with welding filter 100V and hard hat adapter, without hard hat
06-0100-10HASW	Speedglas welding helmet 9100, with side windows, hard hat adapter and welding filter 9100V, without hard hat	06-0100-30HASW	Speedglas welding helmet 9100 with side windows, hard hat adapter and welding filter 9100XX, without hard hat	07-0012-31BL-HH	Speedglas welding helmet 100 with hard hat and welding filter 100V
06-0100-10HHSW	Speedglas welding helmet 9100 with side windows, hard hat and welding filter 9100V			07-0014-00NR	Hard hat adapter for Speedglas welding helmet 100 with hard hat assembly parts, without hard hat (not shown)

3M™ Speedglas™ Welding Helmet Series 9000



Accessories and consumables*

Part No	Description	Part No	Description	Part No	Description
02-0024-00	Sweatband, cotton fleece with padding	04-0126-00	FlexView pivot "S" stop (left), 10/case	04-0290-01	Inside protection plate, +1 shade for welding filters 9002D/9002V, 5/case
02-0024-01	Sweatband, leather	04-0212-02	Speedglas 9000 silver front panel	04-0290-02	Inside protection plate, +2 shade for welding filters 9002D/9002V, 5/case
02-0690-00	Throat protection, black/grey	04-0216-00	Speedglas FlexView silver front panel	04-0315-00	ProTop strap
04-0000-21	Speedglas welding filter 9002X	04-0260-00	Speedglas FlexView protection plate, 10/case	04-0320-00	Battery, 2/case
04-0023-02	Hard hat, white	04-0270-01	Outside protection plate, 10/case	04-0360-00	FlexView welding filter holder
04-0025-00	ProTop welding hood with pivot mechanism, without hard hat, welding filter, without strap	04-0270-03	Outside protection plate, scratch resistant, 10/case	04-0361-00	FlexView middle helmet panel, black
04-0025-00SW	ProTop welding hood with pivot mechanism and side windows, without hard hat, without welding filter, without strap	04-0270-04	Outside protection plate, high temperature, 10/case	04-0380-00	Battery holders blue, 2/case
04-0026-00	Headband pivot "S" stop (right), 10/case	04-0280-00	Inside protection plate for welding filters 9002X/9000XF, 5/case	04-0460-00	FlexView replacement kit
04-0112-00	Speedglas welding helmet 9000, inner shell without side windows	04-0280-01	Inside protection plate, +1 shade for welding filters 9002X/9000XF, 5/case	04-0550-00	FlexView locking wedge kit, holder welding filter (not shown)
04-0112-00SW	Speedglas welding helmet 9000, inner shell with side windows	04-0280-02	Inside protection plate, +2 shade for welding filters 9002X/9000XF, 5/case	04-0650-00	Headband with assembly parts
04-0116-00	FlexView welding helmet inner shell without side windows	04-0290-00	Inside protection plate for welding filters 9002D/9002V, 5/case	06-0700-83	Full hood black/grey
04-0116-00SW	FlexView welding helmet inner shell with side windows			07-0024-02	Sweatband fleece, 2/case

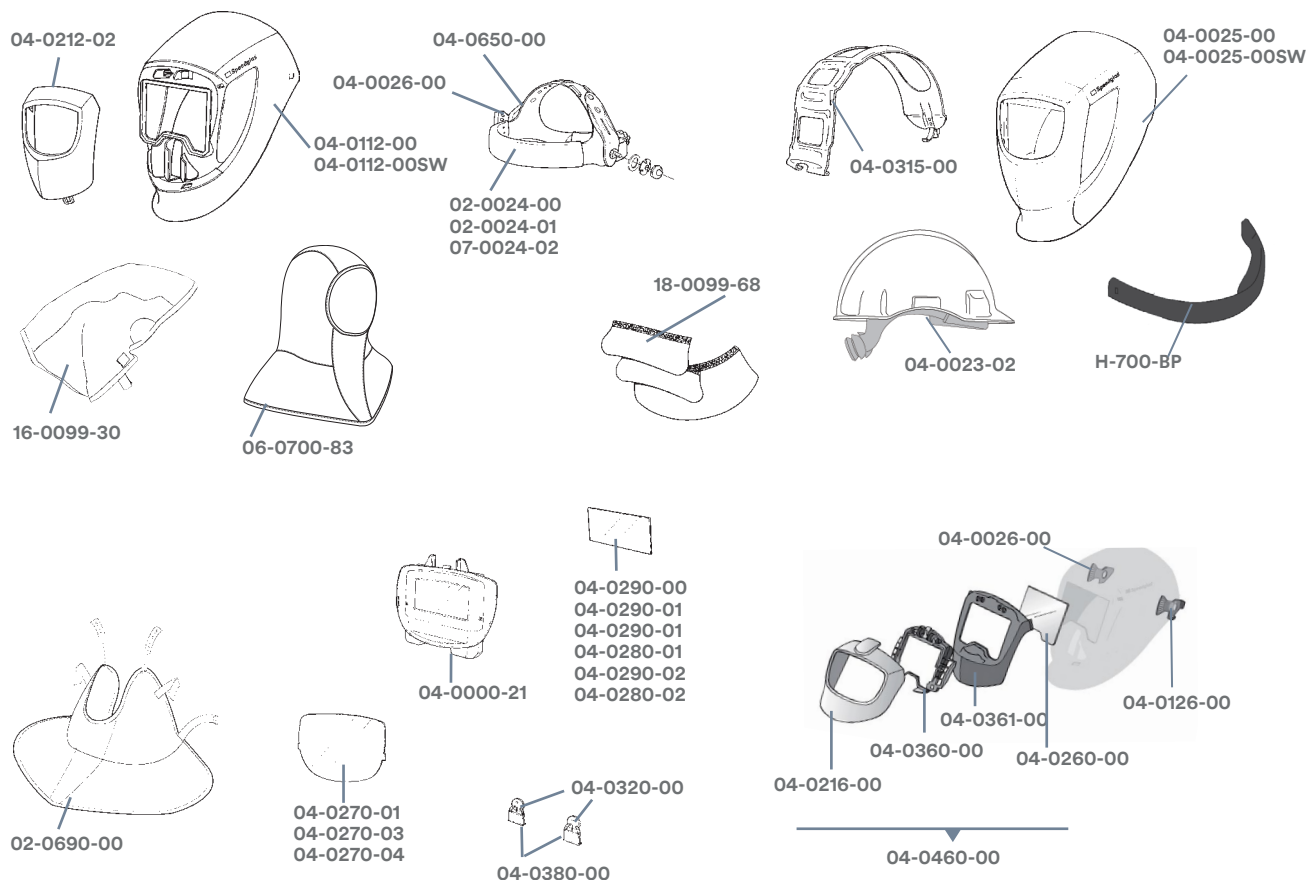

Compatibility of Air Delivery Units and Headtops

The 3M™ Speedglas™ Welding Helmet Series 9100 features breathing tubes with QRS connection (Quick Release Swivel), which enables one-handed connection and release. The SG-30W breathing tube comes standard with most 3M™ Adflo™ PAPR HE Systems and 3M™ Speedglas™ Fresh-air III Supplied Air Systems.

The SG-40W breathing tube is an option for more demanding conditions and also comes standard with complete systems that include the 3M™ Speedglas™ Welding Helmet 9100 MP. The SG-50W breathing tube is standard on the 3M™ Adflo™ PAPR HE/OV-AG systems.

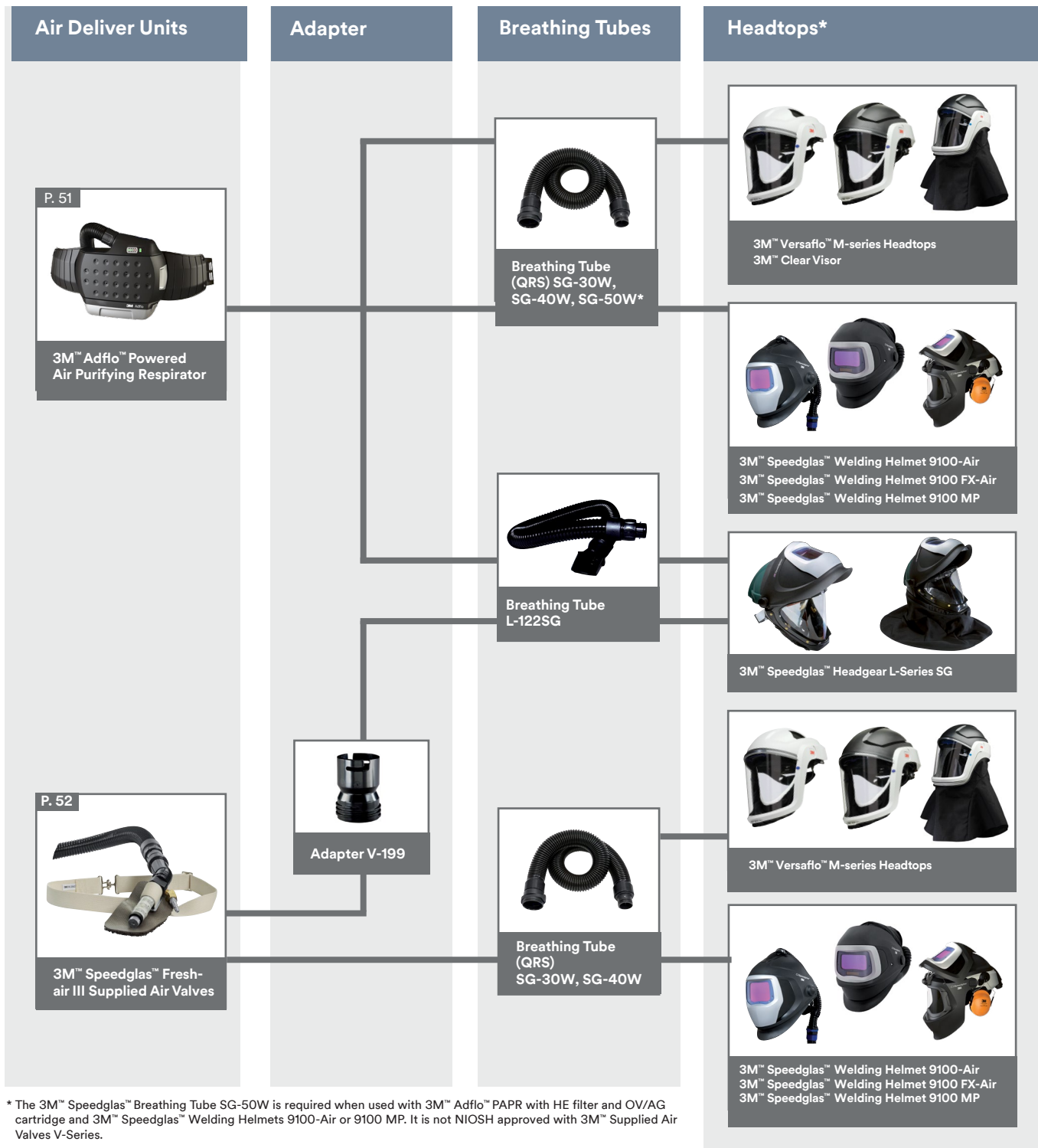

* The 3M™ Speedglas™ Breathing Tube SG-50W is required when used with 3M™ Adflo™ PAPR with HE filter and OV/AG cartridge and 3M™ Speedglas™ Welding Helmets 9100-Air or 9100 MP. It is not NIOSH approved with 3M™ Supplied Air Valves V-Series.

3M™ Adflo™ Powered Air Purifying Respirator

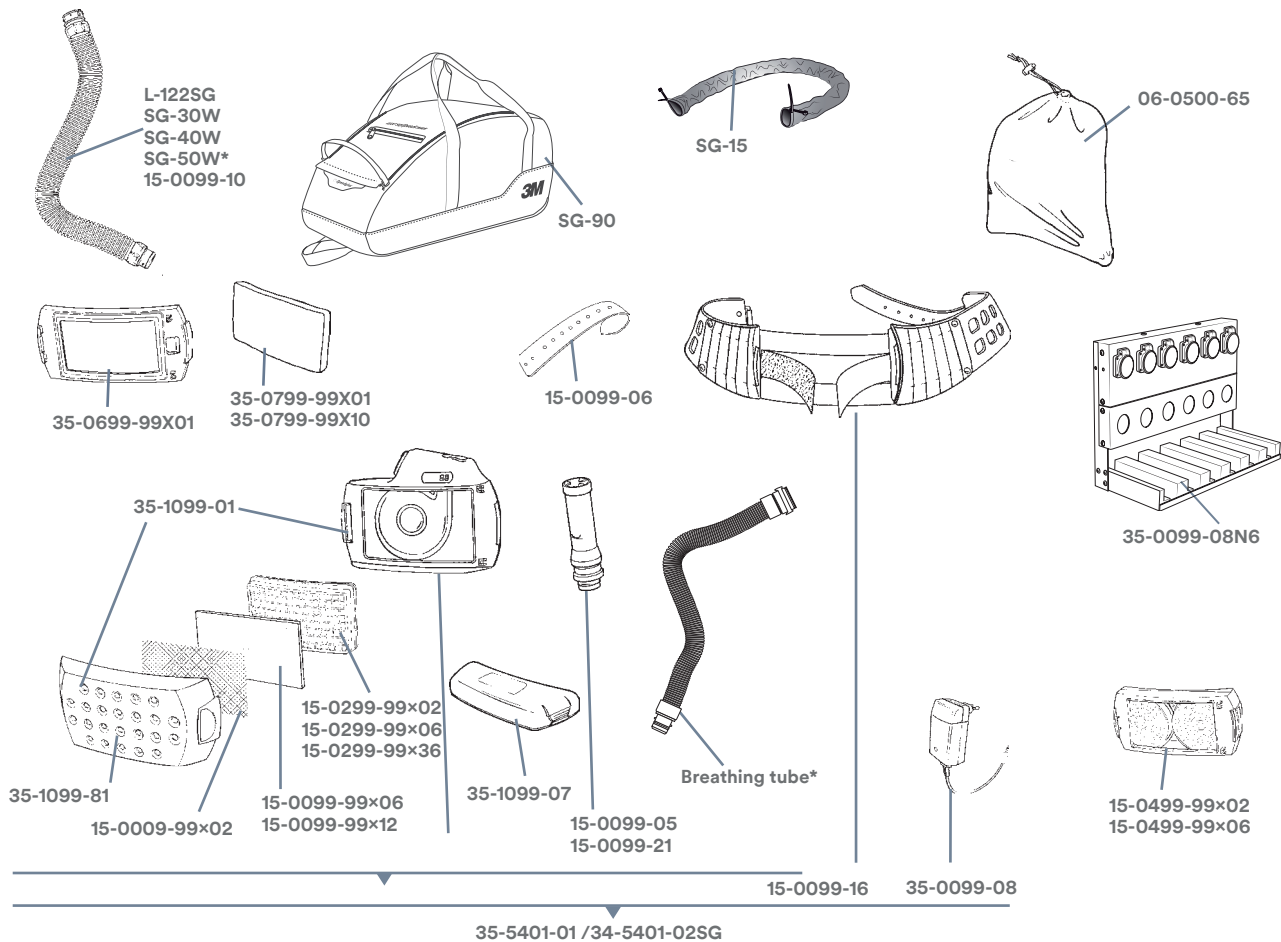

Accessories and consumables

Part No	Description	Part No	Description	Part No	Description
BPK-01	Backpack	(not shown)		35-0099-08	Charger for Li-ion battery
L-122SG	Breathing tube for L-series headgear	15-0099-16	Belt, leather	35-0099-08N6	Docking station for chargers
SG-15	Flame resistant breathing tube cover (replaces 17-0099-54)	15-0099-20	Flow Indicator rubber adapter (not shown)	35-0099-14	Belt connection (not shown)
SG-30W	Breathing tube, self-adjusting, with QRS connection	15-0099-21	Flow Indicator	35-0699-99X01	Nuisance odor filter
SG-40W	Breathing tube, heavy-duty, with QRS connection	15-0099-99×06	Prefilter, 6/c	35-0699-99X01	Nuisance odor filter pad
SG-50W*	Breathing tube, sound-dampening, with QRS connection	15-0099-99×12	Prefilter, 12/c	35-0699-99X01	Nuisance odor filter pad, 10/c
SG-90	Carry bag, black	15-0299-99×06	HE particulate filter, 2/c	35-1099-01	PAPR assembly and filter cover
06-0500-65	Protective bag	15-0299-99×06	HE particulate filter, 6/c	35-1099-07	Battery Li-ion
15-0009-99×02	Spark arrestor, 2/c	15-0299-99×36	HE particulate filter, 36/case	35-1099-81	PAPR filter cover
15-0099-05	Airflow indicator	15-0499-99×02	OV/AG cartridge, 2/case	35-5401-01*	Adflo PAPR with SG-30W self-adjusting breathing tube, airflow indicator, prefilter, spark arrestor, filter cover, HE particulate filter, battery, belt and charger
15-0099-06	Leather belt front extender	15-0499-99×06	OV/AG cartridge, 6/case		
15-0099-08	Charger for NiMH battery	15-1101-99	Battery NiMH		
15-0099-10	Breathing tube assembly (including gasket and o-ring)	15-1101-99	Adflo service kit: HE particulate filters 2/c, prefilters 6/c, spark arrestor 2/c		
15-0099-11	Gasket for non-QRS breathing tubes (not shown)	34-5401-02SG*	Adflo PAPR with L-122SG breathing tube, airflow indicator, prefilter, spark arrestor, filter cover, HE particulate filter, battery, belt and charger		
15-0099-12	Breathing tube rubber o-ring				

* The 3M™ Speedglas™ Breathing Tube SG-50W is required when used with 3M™ Adflo™ PAPR with HE filter and OV/AG cartridge and 3M™ Speedglas™ Welding Helmets 9100-Air or 9100 MP.

3M™ Speedglas™ Fresh-air III Supplied Air System



Part No	Description	Part No	Description	Part No	Description
19-0099-63	Fresh-air III breathing tube V-Series	V-150	Vortex cooling valve	W-2929-50	High pressure air supply hose, 50 ft
SG-30W	Breathing tube, self-adjusting, with QRS connection	V-199	Adapter (for use with SG-30W and SG-40W breathing tubes), 4/case	W-2929-100	High pressure air supply hose, 100 ft
SG-40W	Breathing tube, heavy-duty rubber, with QRS connection	V-200	Vortemp heating assembly, includes valve V-250, belt W-2963 and holder	W-2963	Waist belt, cotton
V-100	Vortex cooling assembly, includes valve V-150, belt W-2963 and holder	V-211	Vortemp muffler kit (replacement muffler for the heating assembly V-200)	W-9435-25	High pressure air supply hose, 25 ft
V-111	Vortex muffler kit (replacement muffler for the cooling assembly V-100)	V-215	Vortemp spare parts kit (for the heating assembly V-200)	W-9435-50	High pressure air supply hose, 25 ft
V-115	Vortex spare parts kit (for the cooling assembly V-100)	V-250	Vortemp heating valve	W-9435-100	High pressure air supply hose, 25 ft
		W-2929-25	High pressure air supply hose, 25 ft		

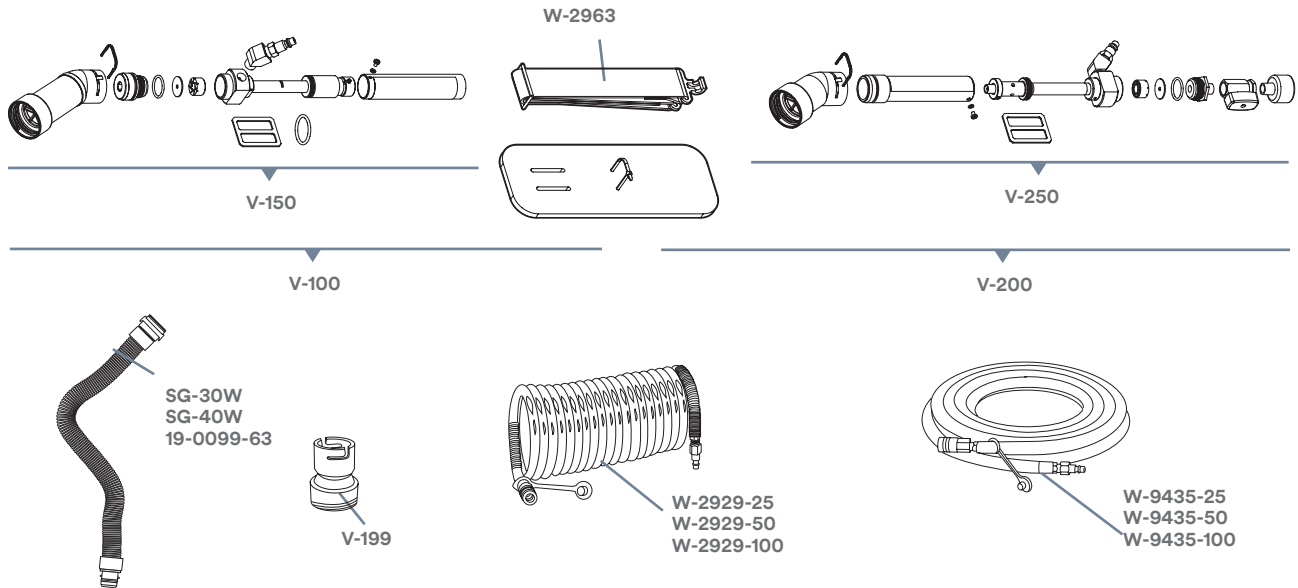

3M™ Speedglas™ Fresh-air II Supplied Air System



Consumables (not shown)

Part No	Description	Part No	Description
18-0099-16	Comfort Belt	18-0099-55	Fresh-air II valve shield
18-0099-40	Air supply hose with couplings, 25 ft.	18-0099-63	Fresh-air II breathing tube
18-0099-41	Air supply hose with couplings, 50 ft.		
18-0099-42	Air supply hose with couplings, 100 ft.		

3M™ Compressed Air Filter and Regulator Panels

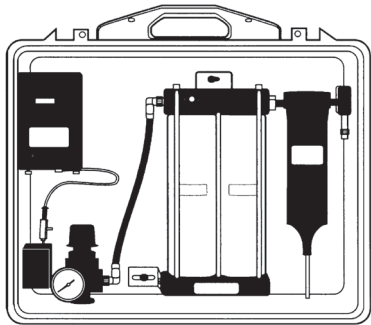

256-02-00 / 256-02-01



W-2806

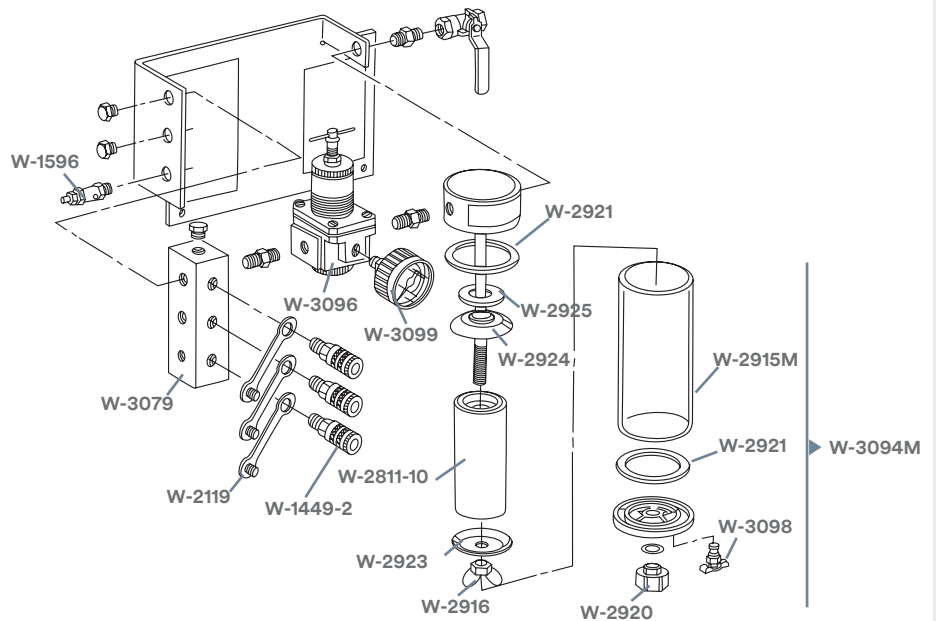

Accessories and consumables

Part No	Description	Part No	Description	Part No	Description
256-02-00	Portable compressed air filter and regulator panel, 50 cfm, 4 outlets, with carbon monoxide filtration and monitor	W-2806	Compressed air filter and regulator panel	W-3096	Air pressure regulator
256-02-01	Portable compressed air and regulator panel, 100 cfm, 8 outlets, with carbon monoxide monitor	W-2808	CO monitor with retrofit kit (not shown)	W-3098	Drain valve
529-04-50	Adapter, 110-120 Volts AC (not shown)	W-2811-10	Filter cartridge, 10/case	W-3099	Air pressure gauge
529-04-48	Calibration kit, large (not shown)	W-2915M	Aluminum filter bowl	W-3182-2	Socket, 3/8 in MPT, 1/4 in body size, schrader, 2/case (not shown)
529-04-49	Calibration kit, small (not shown)	W-2916	Wing nut	W-3281-2	Socket, hansen S23 (3/8 in Male NPT), 2/case (not shown)
529-05-20	Remote alarm and strobe audible (not shown)	W-2920	Nut base		
W-1449-2	Socket, 3/8 in MPT, 1/4 in body size, industrial interchange, 2/case	W-2921	Bowl gasket		
W-1596	Pressure relief valve	W-2923	Cartridge washer		
W-2119	Socket dust cap	W-2924	Air deflector		
		W-2925	Air deflector gasket		
		W-3012	Coalescing filter assembly		
		W-3013-4	High efficiency filter element for W-3012 (not shown), 4/case		
		W-3079	Manifold		
		W-3094M	Filter housing assembly		
		W-3095	Filter housing base (part of W-3094M)		

3M™ Speedglas™ Welding Helmet 9100-Air for Respiratory Protection



Part No	Description	Part No	Description	Part No	Description
35-1101-00SW	Speedglas welding helmet 9100-Air without welding filter with Adflo PAPR and HE filter	35-3301-10SW	Speedglas welding helmet 9100-Air with welding filter 9100V and Adflo PAPR with HE filter and OV/AG cartridge	25-5702-30SW	Speedglas welding helmet 9100-Air with welding filter 9100XX and Fresh-air III SAR, V-100 valve
35-1101-10SW	Speedglas welding helmet 9100-Air with welding filter 9100V and Adflo PAPR with HE filter	35-3301-20SW	Speedglas welding helmet 9100-Air with welding filter 9100X and Adflo PAPR with HE filter and OV/AG cartridge	25-5702-30iSW	Speedglas welding helmet 9100-Air with welding filter 9100XXi and Fresh-air III SAR, V-100 valve
35-1101-20SW	Speedglas welding helmet 9100-Air with welding filter 9100X and Adflo PAPR with HE filter	35-3301-30SW	Speedglas welding helmet 9100-Air with welding filter 9100XX and Adflo PAPR with HE filter and OV/AG cartridge	25-5802-10SW	Speedglas welding helmet 9100-Air with welding filter 9100V and Fresh-air III SAR, V-200 valve
35-1101-30SW	Speedglas welding helmet 9100-Air with welding filter 9100XX and Adflo PAPR with HE filter	25-5702-10SW	Speedglas welding helmet 9100-Air with welding filter 9100V and Fresh-air III SAR, V-100 valve	25-5802-20SW	Speedglas welding helmet 9100-Air with welding filter 9100X and Fresh-air III SAR, V-200 valve
35-1101-30iSW	Speedglas welding helmet 9100-Air with welding filter 9100XXi and Adflo PAPR with HE filter	25-5702-20SW	Speedglas welding helmet 9100-Air without welding filter, with Adflo PAPR, HE filter and OV/AG cartridge	25-5802-30SW	Speedglas welding helmet 9100-Air with welding filter 9100XX and Fresh-air III SAR, V-200 valve

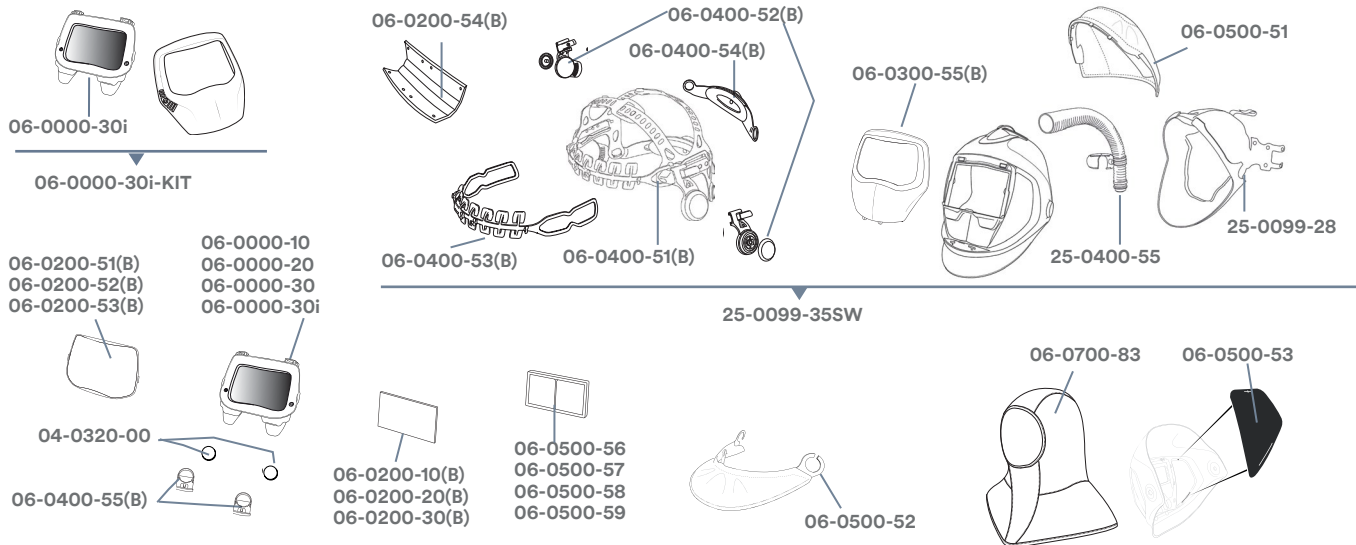

Accessories and consumables

Part No	Description	Part No	Description	Part No	Description
04-0320-00	Battery, 2/case	06-0200-51-B	Part no 06-0200-51, 50/case	06-0400-54	Headband back part
06-0000-10	Welding filter 9100V	06-0200-52	Outside protection plate scratch resistant, 10/case	06-0400-54-B	Part no 06-0400-54, 5/case
06-0000-20	Welding filter 9100X	06-0200-52-B	Part no 06-0200-52, 50/case	06-0400-55	Battery holder 9100, 2/case
06-0000-30	Welding filter 9100XX	06-0200-53	Outside protection plate high temperature, 10/case	06-0400-55-B	Part no 06-0400-55, 10/case
06-0000-30i	Welding filter 9100XXi	06-0200-53-B	Part no 06-0200-53, 50/case	06-0500-51	Extended coverage, crown
06-000030iKIT	Welding filter kit 9100XXi, (filter and silver front)	06-0200-54	Comfort sweatband, 3/case	06-0500-52	Extended coverage, ear and neck
06-0200-10	Inside protection plate 9100V, 5/case	06-0200-54-B	Comfort sweatband, 12/case	06-0500-53	SideWindow cover plates, 2/case
06-0200-10-B	Part no 06-0200-10, 25/case	06-0300-55	Silver front panel	06-0500-56	Magnification plate 15x
06-0200-20	Inside protection plate 9100X, 5/case	06-0400-51	Headband incl assembled parts	06-0500-57	Magnification plate 20x
06-0200-20-B	Part no 06-0200-20, 25/case	06-0400-51-B	Part no 06-0400-51, 5/case	06-0500-58	Magnification plate 25x
06-0200-30	Inside protection plate 9100XX/9100XXi, 5/case	06-0400-52	Pivot mechanism headband, left and right	06-0500-59	Magnification plate 30x
06-0200-30-B	Part no 06-0200-30, 25/case	06-0400-52-B	Part no 06-0400-52, 5/case	06-0700-83	Full hood, black/grey
06-0200-51	Outside protection plate standard, 10/case	06-0400-53	Headband front part	25-0099-28	Face seal
		06-0400-53-B	Part no 06-0400-53, 5/case	25-0099-35SW	Welding helmet 9100-Air, without welding filter
				25-0400-55	Air duct tube

3M™ Speedglas™ Welding Helmet 9100 FX-Air for Respiratory Protection



Part No	Description	Part No	Description	Part No	Description
36-1101-00SW	Welding helmet 9100 FX-Air without welding filter with Adflo PAPR and HE filter	36-1101-30SW	Welding helmet 9100 FX-Air with welding filter 9100XX and Adflo PAPR with HE filter	36-3301-20SW	Welding helmet 9100 FX-Air with welding filter 9100X and Adflo PAPR with HE filter and OV/AG cartridge
36-1101-10SW	Welding helmet 9100 FX-Air with welding filter 9100V and Adflo PAPR with HE filter	36-3301-00SW	Welding helmet 9100 FX-Air, without welding filter, with Adflo PAPR, HE filter and OV/AG cartridge	36-3301-30SW	Welding helmet 9100 FX-Air with welding filter 9100XX and Adflo PAPR with HE filter and OV/AG cartridge
36-1101-20SW	Welding helmet 9100 FX-Air with welding filter 9100X and Adflo PAPR with HE filter	36-3301-10SW	Welding helmet 9100 FX-Air with welding filter 9100V and Adflo PAPR with HE filter and OV/AG cartridge		

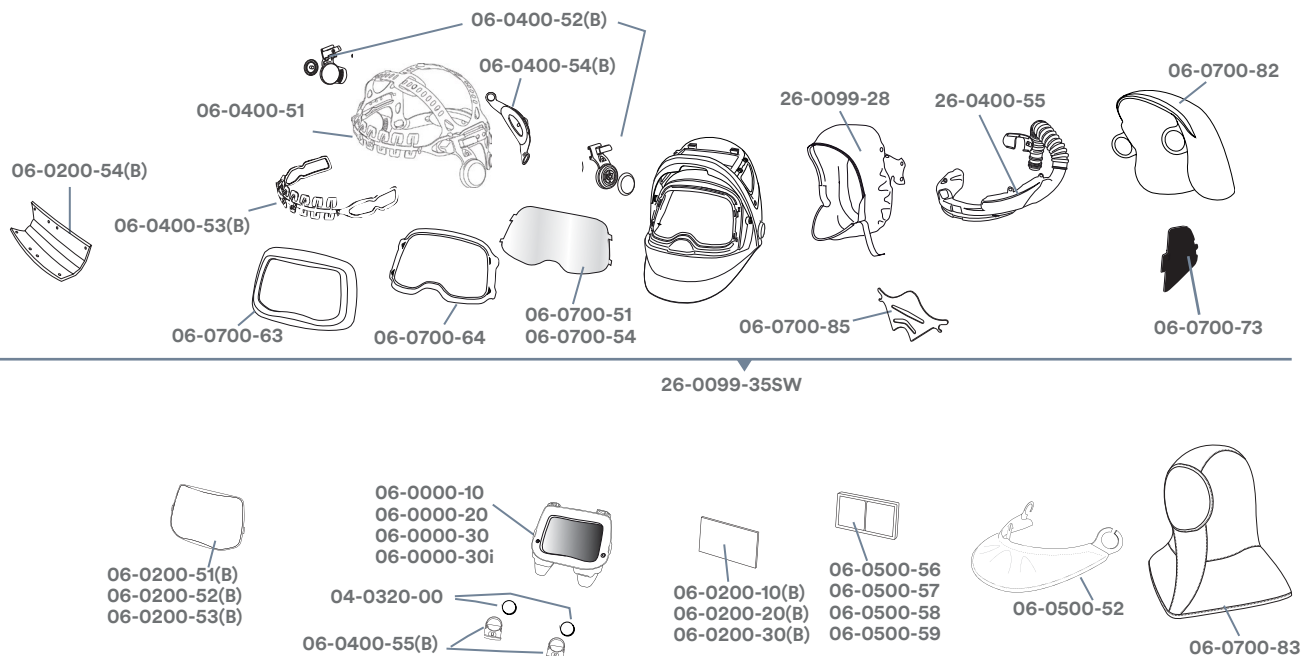

Accessories and consumables

Part No	Description	Part No	Description	Part No	Description
04-0320-00	Battery, 2/case	06-0200-53	Outside protection plate high temperature, 10/case	06-0500-52	Extended coverage, ear and neck
06-0000-10	Welding filter 9100V	06-0200-53-B	Part no 06-0200-53 (bulk), 50/case	06-0500-56	Magnification plate 15x
06-0000-20	Welding filter 9100X	06-0200-54	Comfort sweatband, 3/case	06-0500-57	Magnification plate 20x
06-0000-30	Welding filter 9100XX	06-0200-54-B	Comfort sweatband (bulk), 12/case	06-0500-58	Magnification plate 25x
06-0000-30i	Welding filter 9100XXi	06-0400-51	Headband incl assembled parts	06-0500-59	Magnification plate 30x
06-0200-10	Inside protection plate 9100V, 5/case	06-0400-51-B	Part no 06-0400-51 (bulk), 25/case	06-0700-51	Wide-view clear grinding visor, standard, 5/case
06-0200-10-B	Part no 06-0200-10 (bulk), 25/case	06-0400-52	Pivot mechanism headband, left and right	06-0700-54	Wide-view clear grinding visor, anti-fog, 5/case
06-0200-20	Inside protection plate 9100X, 5/case	06-0400-52-B	Part no 06-0400-52 (bulk), 5/case	06-0700-63	Front panel, chrome
06-0200-20-B	Part no 06-0200-20 (bulk), 25/case	06-0400-53	Headband front part	06-0700-64	Wide-view clear grinding visor frame, black
06-0200-30	Inside protection plate 9100XX and 9100XXi, 5/case	06-0400-53-B	Part no 06-0400-53 (bulk), 5/case	06-0700-73	SideWindow cover plates, 2/case
06-0200-30-B	Part no 06-0200-30 (bulk), 25/case	06-0400-54	Headband back part	06-0700-82	Extended head cover, head and neck
06-0200-51	Outside protection plate standard, 10/case	06-0400-54-B	Part no 06-0400-54 (bulk), 5/case	06-0700-83	Full hood, black/grey
06-0200-51-B	Part no 06-0200-51 (bulk), 50/case	06-0400-55	Battery holder 9100, 2/case	06-0700-85	Air diffuser
06-0200-52	Outside protection plate scratch resistant, 10/case	06-0400-55-B	Part no 06-0400-55 (bulk), 10/case	26-0099-28	Face seal
06-0200-52-B	Part no 06-0200-52 (bulk), 50/case			26-0099-35SW	Welding helmet 9100 FX-Air without welding filter, with headband
				26-0400-55	Duct assembly

3M™ Speedglas™ Welding Helmet 9100 MP



Part No	Description	Part No	Description	Part No	Description
37-1101-00SW	Welding helmet 9100 MP without welding filter, with Adflo PAPR and HE filter	37-5702-00SWSR	Welding helmet 9100 MP without welding filter, with Fresh-air III SAR, V-100SR valve and Schrader fitting	37-5902-10SW	Welding helmet 9100 MP with welding filter 9100V and Fresh-air III SAR, V-300 valve
37-1101-10SW	Welding helmet 9100 MP with welding filter 9100V and Adflo PAPR with HE filter	37-5702-10SW	Welding helmet 9100 MP with welding filter 9100V and Fresh-air III SAR, V-100 valve	37-5902-20SW	Welding helmet 9100 MP with welding filter 9100X and Fresh-air III SAR, V-300 valve
37-1101-20SW	Welding helmet 9100 MP with welding filter 9100X and Adflo PAPR with HE filter	37-5702-20SW	Welding helmet 9100 MP with welding filter 9100X and Fresh-air III SAR, V-100 valve	37-5902-30SW	Welding helmet 9100 MP with welding filter 9100XX and Fresh-air III SAR, V-300 valve
37-1101-30SW	Welding helmet 9100 MP with welding filter 9100XX and Adflo PAPR with HE filter	37-5702-30SW	Welding helmet 9100 MP with welding filter 9100XX and Fresh-air III SAR, V-100 valve		

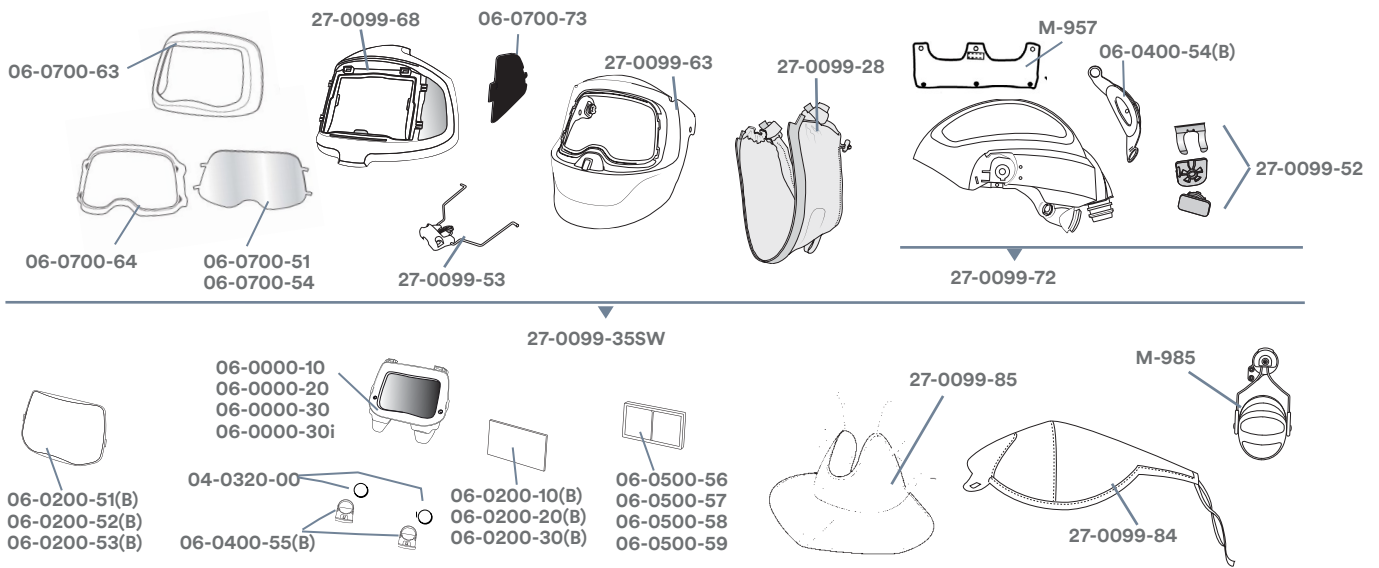

Accessories and consumables

Part No	Description	Part No	Description	Part No	Description
M-350	Versaflo replacement head suspension (not shown above)	06-0200-51-B	Part no 06-0200-51 (bulk), 50/case	06-0400-55	Battery holder 9100, 2/case
M-957	Versaflo forehead comfort pad/sweat pad, 10/case	06-0200-52	Outside protection plate scratch resistant, 10/case	06-0400-55-B	Part no 06-0400-55 (bulk), 10/case
M-985	3M™ PELTOR™ Earmuff Assembly Kit	06-0200-52-B	Part no 06-0200-52 (bulk), 50/case	06-0700-51	Wide-view clear grinding visor, standard, 5/case
04-0320-00	Battery, 2/case	06-0200-53	Outside protection plate high temperature, 10/case	06-0700-54	Wide-view clear grinding visor, anti-fog, 5/case
06-0000-10	Welding filter 9100V	06-0200-53-B	Part no 06-0200-53 (bulk), 50/case	06-0700-63	Front panel, chrome
06-0000-20	Welding filter 9100X	06-0202-10	Starter kit 9100V (for 9100 MP), incl 5 outside protection plates, 2 inside protection plates, and 1 sweat pad	06-0700-64	Wide-view clear grinding visor frame, black
06-0000-30	Welding filter 9100XX	06-0202-20	Starter kit 9100X (for 9100 MP), incl 5 outside protection plates, 2 inside protection plates, and 1 sweat pad	06-0700-73	SideWindow cover plates, 2/case
06-0000-30i	Welding filter 9100XXi	06-0202-30	Starter kit 9100XX (for 9100 MP), incl 5 outside protection plates, 2 inside protection plates, and 1 sweat pad	27-0099-28	Face seal
06-0200-10	Inside protection plate 9100V, 5/case	06-0400-54	Headband back part	27-0099-35SW	Welding helmet 9100 MP with hard hat, without welding filter
06-0200-10-B	Part no 06-0200-10 (bulk), 25/case	06-0400-54-B	Part no 06-0400-54 (bulk), 5/case	27-0099-52	Pivot kit
06-0200-20	Inside protection plate 9100X, 5/case			27-0099-53	Flip-up mechanism
06-0200-20-B	Part no 06-0200-20 (bulk), 25/case			27-0099-63	Inner shield
06-0200-30	Inside protection plate 9100XX/9100XXi, 5/case			27-0099-68	Outer shield
06-0200-30-B	Part no 06-0200-30 (bulk), 25/case			27-0099-72	Hard hat incl pivot kit
06-0200-51	Outside protection plate standard, 10/case			27-0099-84	Radiant heat hard hat cover for 9100 MP helmet
				27-0099-85	Throat and neck coverage
				27-0099-87	Complete neck coverage for 9100MP

3M™ Versaflo™ Headtops M-Series

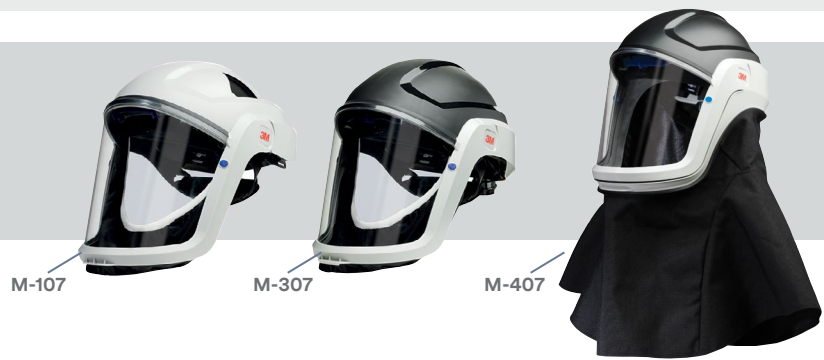

Part No	Description	Part No	Description	Part No	Description
M-107	Versaflo Faceshield M-107	M-307	Versaflo Helmet M-307	M-407	Versaflo Helmet with shroud M-407
M-207	Versaflo Faceshield M-207				

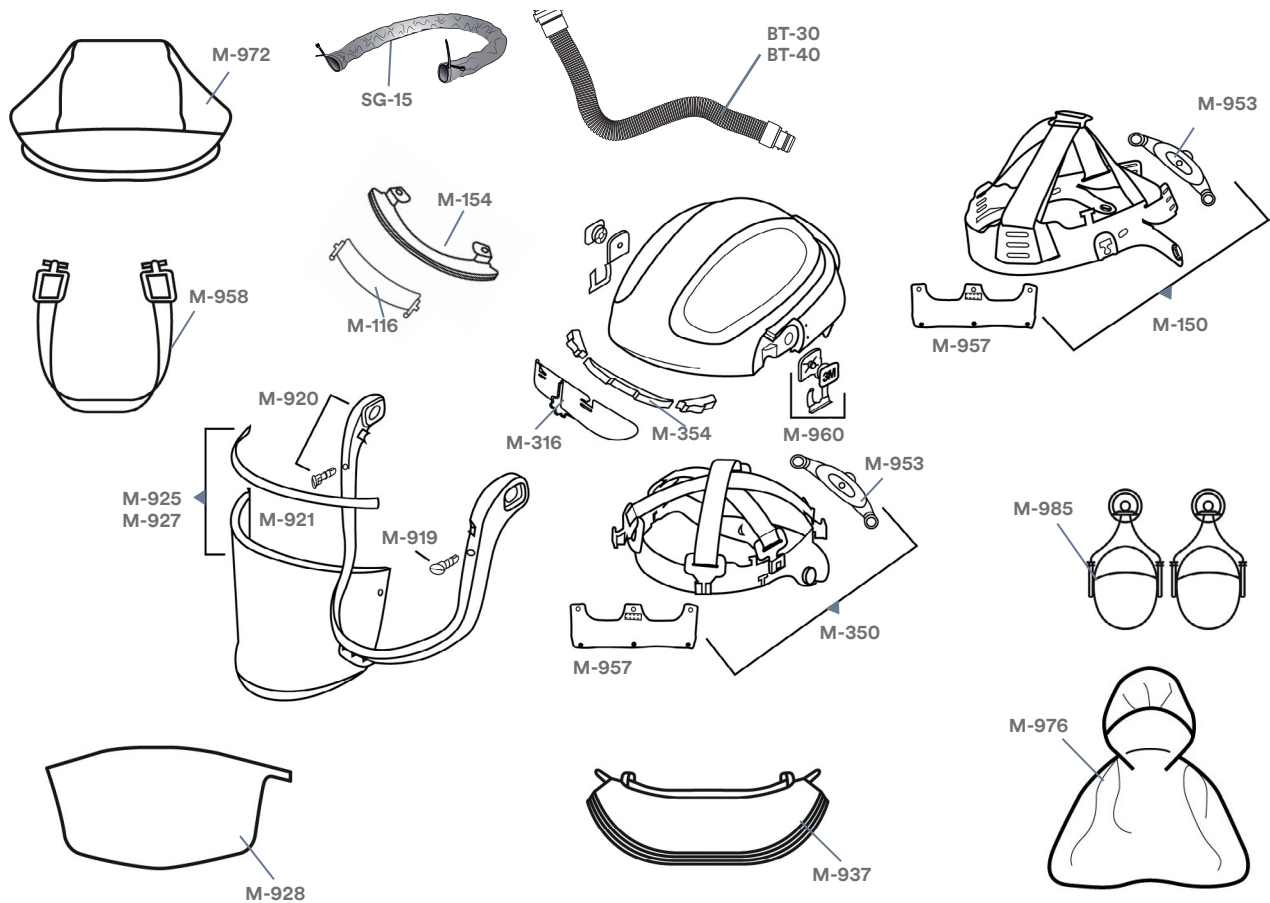

Accessories and spare parts

Part No	Description	Part No	Description	Part No	Description
BT-30	Breathing tube, self-adjusting (52,5 to 85 cm), with QRS connection	M-920	Visor frame	M-972	Flame resistant headtop cover
BT-40	Breathing tube, heavy-duty rubber, with QRS connection	M-921	Visor gasket	M-976	Head, neck and shoulder cover
M-116	Airflow deflector (M-107)	M-925	Visor standard (uncoated)	M-985	3M™ PELTOR™ Ear Muffs
M-150	Head suspension (M-107)	M-927	Visor coated	SG-15	Flame resistant breathing tube cover
M-154	Forehead seal (M-107)	M-928	Peel-off visor cover		
M-316	Airflow deflector (M-307)	M-937	Flame resistant faceseal		
M-350	Head suspension (M-307)	M-953	Ratchet		
M-354	Forehead seal (M-307)	M-956	Ratchet comfort pad		
M-919	Visor frame buttons	M-957	Sweatband, fleecy cotton, pkg of 2		
		M-958	Chin strap		
		M-960	Pivot kit		

3M™ Speedglas™ Welding Helmet 9000 HWR and FlexView HWR for Respiratory Protection



Part No	Description	Part No	Description	Part No	Description
02-0024-01	Sweatband, leather	04-0280-01	Inside protection plate, +1 shade, for filters 9002X/9000XF, 5/case	04-0460-00	FlexView replacement kit
02-0690-00	Throat protection black/grey	04-0280-02	Inside protection plate, +2 shade, for filters 9002X/9000XF, 5/case	06-0500-56	Magnification plate 15x
04-0000-21	Speedglas welding filter 9002X, variable shade 9-13	04-0290-00	Inside protection plate for filters 9002D/9002V, 5/case	06-0500-57	Magnification plate 20x
04-0026-00	Headband pivot "S" stop, right, 10/case	04-0290-01	Inside protection plate, +1 shade, for filters 9002D/9002V, 5/case	06-0500-58	Magnification plate 25x
04-0067-00	Assembly parts for headband	04-0290-02	Inside protection plate, +2 shade, for filters 9002D/9002V, 5/case	06-0700-83	Full hood black/grey
04-0126-00	FlexView pivot "S" stop, left, 10/case	04-0320-00	Battery, 2/case	07-0024-02	Sweatband, fleece, 2/case
04-0212-02	Silver front panel	04-0360-00	FlexView welding filter holder	14-0099-28	Face seal 9000 HWR
04-0270-01	Outside protection plate, standard, 10/case	04-0361-00	FlexView middle helmet panel, black	14-0099-29	Headband assembly 9000 HWR, with air duct
04-0270-03	Outside protection plate, scratch resistant, 10/case	04-0380-00	Battery holder blue, 2/case	14-0099-32	Inner shell 9000 HWR, without air duct
04-0270-04	Outside protection plate, high temperature, 10/case			15-1699-28	FlexView HWR faceseal
04-0270-00	Inside protection plate, for filters 9002X/9000XF, 5/case			15-1699-29	Headband assembly FlexView HWR, with air duct
				16-0099-30	Head cover, FR cotton
				18-0099-68	Throat and side protector, leather

* Please use Part No 14-0099-SW or 15-1699-32SW to replace the side windows.

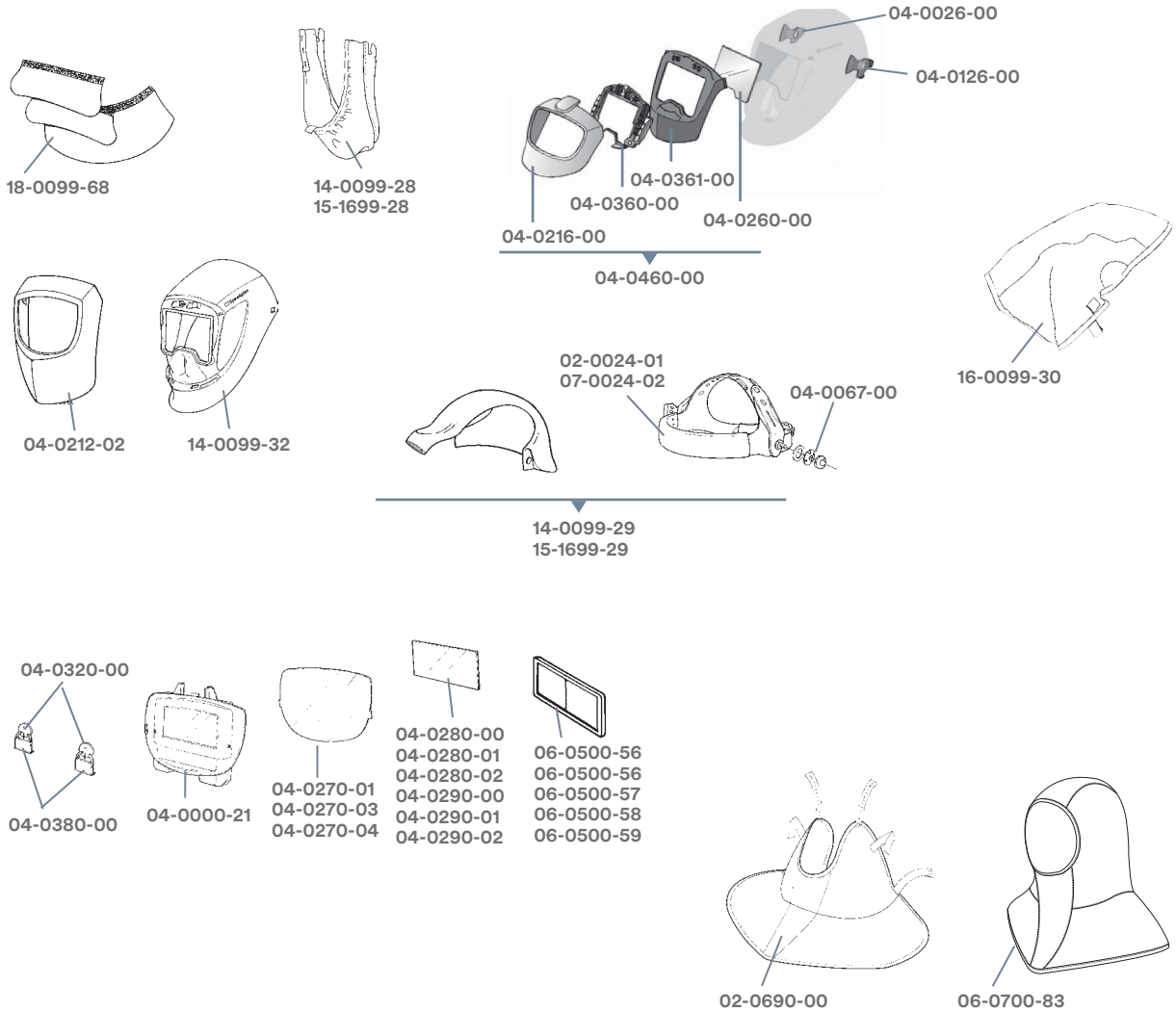

3M™ Headgear L-Series with 3M™ Adflo™ Powered Air Purifying Respirator



Part No	Description	Part No	Description	Part No	Description
34-0705-SGV	Hard Hat L-705SG wideview faceshield with Speedglas welding filter 9100V and Adflo PAPR with HE filter	34-0705-SGXX	Hard Hat L-705SG wideview faceshield with Speedglas welding filter 9100XX and Adflo PAPR with HE filter	34-0905-SGX	Helmet L-905SG wideview faceshield with Speedglas welding filter 9100X and Adflo PAPR with HE filter
34-0705-SGX	Hard Hat L-705SG wideview faceshield with Speedglas welding filter 9100X and Adflo PAPR with HE filter	34-0905-SGV	Helmet L-905SG wideview faceshield with Speedglas welding filter 9100V and Adflo PAPR with HE filter	34-0905-SGXX	Helmet L-905SG wideview faceshield with Speedglas welding filter 9100XX and Adflo PAPR with HE filter

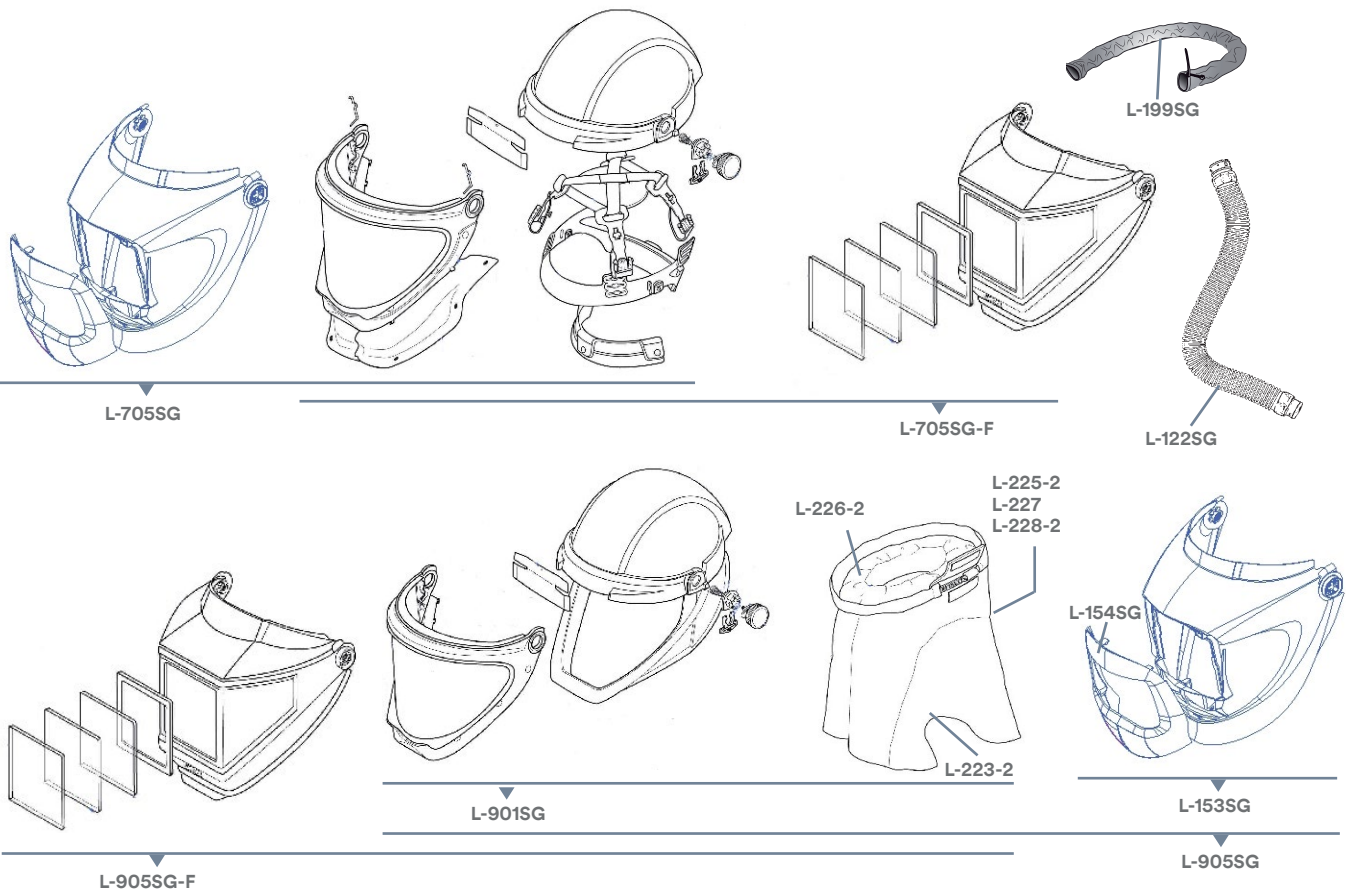

Accessories and consumables

Part No	Description	Part No	Description	Part No	Description
L-122SG	Breathing tube	L-705SG	Hardhat with welding helmet and wideview faceshield, without welding filter	L-905SG-F	Helmet with welding helmet and wideview faceshield
L-153SG	Welding helmet kit			15-0099-20	Adflo flow indicator rubber adapter for L-SG type systems (not shown)
L-154SG	Silver front panel	L-705SG-F	Hardhat with welding helmet and wideview faceshield	15-0099-21	Adflo flow indicator for L-SG type systems (not shown)
L-199SG	Breathing tube cover, high temperature	L-901SG	Helmet with wideview faceshield	15-5401-02SG	Adflo PAPR assembly (not shown)
L-223-2	Outer shroud standard	L-905SG	Helmet with welding helmet and wideview faceshield, without welding filter		
L-225-2	Outer shroud, flame retardant				
L-226-2	Inner shroud				
L-227	Outer shroud, flame retardant, leather				
L-228-2	Outer shroud, nylon				

3M™ Faceshield ClearVisor with 3M™ Adflo™ Powered Air Purifying Respirator

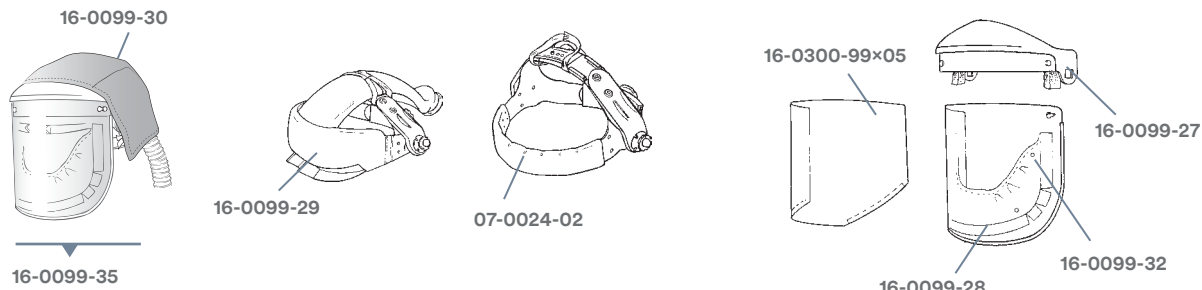

Part No	Description	Part No	Description	Part No	Description
07-0024-02	Sweatband, fleece, 2/case	16-0099-30	Headcover, FR cotton	16-0099-35	ClearVisor polycarbonate
16-0099-27	Brow guard	16-0099-32	Clear window with fasteners and face seal, without brow guard	16-0300-99x05	Clear window strip off shielding film, 5/case
16-0099-28	Face seal				
16-0099-29	Face seal and headband assembly with air duct				



Care and Maintenance

Every day welding sparks, heat, fumes, and normal wear-and-tear grind away at your protection equipment. Therefore, we designed all 3M™ Speedglas™ Personal Protective Equipment with ease of maintenance in mind. Replacement parts can be installed by hand, without tools. For maximum safety and comfort, inspect your equipment daily and make it a regular habit to check and change the following items. Please consult the user instructions for further details.



System	Component	Typically Replaced	Notes
Welding Filters	Outside Protection Plate	Once a week	Replace anytime the plate becomes deeply pitted, scratched or too dirty to clean with soft cloth or lens paper
Welding Filters	Inside Protection Plate	Once a month	Regularly clean with a soft cloth and replace if any pits or scratches occur
Welding Helmets	Visor Plate	Every two weeks	Replace more often if visibility is reduced
Welding Helmets	Sweatband	Once a month	Replace more often if sweatband becomes unhygienic
PAPR	Prefilter	Once a week	Regular replacement of the prefilter extends the life of the particle filter, saving money while also increasing the battery run-time
PAPR	Particle Filter	At least every month	Replace when particle filter indicator becomes red or if filter is damaged. Otherwise, replace whenever the battery operating time becomes too short, or when "fully loaded" filter triggers low airflow alarm
PAPR	OV/AG Cartridge	At least every 3 or 4 weeks	Immediately replace the cartridge according to the established cartridge change out schedule or any time you can smell odors while wearing the PAPR
PAPRs	Spark arrestor	As needed	Replace if deformed and no longer fitting well
Respirators	Breathing Tube	As needed	If damaged, deformed or leaking any air and if holes, cuts, or tears are noticed. To extend the life of breathing tube, use a tube cover or a heavy-duty rubber reathing tube
Welding Helmets with PAPRs	Face Seal	At least every 2 months	Replace earlier in really dirty environments or whenever the seal becomes unhygienic, also if damaged (holes, cuts, tears)

Important information Note that higher-than-normal levels of pollutants, heat, and sparks will require more frequent replacement of components. Chart assumes minimum 4 hours usage per day. Ordering information for each series of welding helmet can be found in the Parts Directory.

Technical Data 3M™ Speedglas™ Welding Helmets and Welding Filters

- Best**
- Better**
- Good**
- Not Recommended**



	3M™ Speedglas™ Welding Helmet 9100 MP				3M™ Speedglas™ Welding Helmets 9100 FX and 9100 FX-Air			
3M™ Speedglas™ Welding Filter Options	9100XXi Filter	9100XX Filter	9100X Filter	9100V Filter	9100XXi Filter	9100XX Filter	9100X Filter	9100V Filter
MMAW (Electrode)	Best	Best	Best	Best	Best	Best	Best	Best
MIG/MAG	Best	Best	Best	Best	Best	Best	Best	Best
TIG (>20A)	Best	Best	Best	Best	Best	Best	Best	Best
TIG (1A-20A)	Best	Best	Best	Best	Best	Best	Best	Best
Plasma (welding and cutting)	Best	Best	Best	Best	Best	Best	Best	Best
Risk for hidden arc	Best	Best	Best	Best	Best	Best	Best	Best
Tack welding	Best	Best	Best	Best	Best	Best	Best	Best
Grinding (welding filter)	Better	Better	Better	Better	Better	Better	Better	Better
Grinding (clear visor)	Best	Best	Best	Best	Best	Best	Best	Best
Viewing area (welding filter)	2.8 × 4.2 in. (72×107 mm)	2.8 × 4.2 in. (72×107 mm)	2.1 × 4.2 in. (54×107 mm)	1.8 × 3.7 in. (45×93 mm)	2.8 × 4.2 in. (72×107 mm)	2.8 × 4.2 in. (72×107 mm)	2.1 × 4.2 in. (54×107 mm)	1.8 × 3.7 in. (45×93 mm)
Battery lifetime	1 800 hours	2 000 hours	2 500 hours	2 800 hours	1 800 hours	2 000 hours	2 500 hours	2 800 hours
Solar cell	No		Yes		No		Yes	
Hard hat options	Yes				Yes (non-air version)			
Classification (per EN 379)*	1 / 1 / 1 / 2				1 / 1 / 1 / 2			
Dark state	Shade 5, 8, 9–13				Shade 5, 8, 9–13			
Light state	Shade 3				Shade 3			
UV/IR Protection	Shade 13 (permanent)				Shade 13 (permanent)			
Auto ON	Yes	No			Yes	No		
Switching time, light -dark	0.1 ms (+23° C)				0.1 ms (+23° C)			
Delay (switching time, dark-light)	40–1 300 ms				40–1 300 ms			
Side windows option	Yes				Yes			
Exhaust vents	N/A				Yes (non-air version)			
Number of sensors (arc detection)	3				3			
Approvals Head, Eye and Face protection Welding helmet and filter, protection plates Hard Hat	ANSI Z87.1 - 2010 ANSI Z89.1-2009 -Type 1, Class G				ANSI Z87.1 - 2010 N/A			
Approval Respiratory Protection Adflo powered air purifying respirator Fresh-air III supplied air valve	APF 25 APF 25				with Speedglas welding helmet 9100 FX-Air APF 25 APF 25			

* Auto-darkening welding filters have a four-part classification: optical class / diffusion of light / variation on luminous transmittance / angle dependence. Classifications range from 1/1/1/2 to 4/4/4/4.
 ** The ratings (good - better - best) above refer to the products listed in this chart and should be seen as general recommendations based on differences in product comfort features.

Technical Specifications of 3M™ Air Delivery Units for Welding Safety

Technical Specifications	3M™ Adflo™ Powered Air Purifying Respirator	3M™ Speedglas™ Fresh-air III Supplied Air Regulator
Filters / Cartridges	HE particle filter OV/AG cartridge	N/A
Airflow	7 CFM (200 l/min)	6-15 CFM
Air Pressure Air Quality	N/A N/A	Varies with hose length. See product user instructions. V-100/200: 62–91 psig V-300: 30–63 psig
Weight (approx.) PAPR (with belt and HE filter) / Valve (without pad or belt)	2.6 lbs	V-100: 12.3 oz V-200: 14.8 oz V-300: 9.5 oz
Battery Charging time Operating hours*	NiMH Less than 4 hours 5–6 hours (OV/AG cartridge + HE filter) 8-10 hours (HE filter)	N/A
Belt Optional extension	Leather, 30–45 in. +26 in.	Cotton, up to 53 in.
Temperature range Operation Storage	23°F to 131°F -4°F to 131°F	23°F to 131°F -4°F to 131°F
* Run times are with new, fully-charged batteries and new filters /cartridges.		

Technical Specifications of 3M™ Faceshields and Helmets

Technical Specifications	3M™ Versaflo™ Faceshield M-107	3M™ Versaflo™ Helmet M-207	3M™ Versaflo™ Helmet M-307	3M™ Versaflo™ Helmet M-407
Material Visor Faceseal	Polycarbonate Polyester	Polycarbonate Polyester	Polycarbonate Polyester	Polycarbonate Polyaramid
Approval Eye and Face protection Protective Visor (M-927) Protective Visor (M-925)	ANSI Z87.1-2010 ANSI Z87.1-2010	ANSI Z87.1-2010 ANSI Z87.1-2010	ANSI Z87.1-2010 ANSI Z87.1-2010	ANSI Z87.1-2010 ANSI Z87.1-2010
Approval Head protection Helmet	N/A	EN 397	EN 397	EN 397
Approval Respiratory Protection Adflo powered air respirator Fresh-air III supplied air valve	APF 25 APF 25	APF 25 APF 25	APF 25 APF 25	APF 25 APF 25

Product Index

Part No	3M ID No	Page	Part No	3M ID No	Page
L-122SG	70071516523	48–49, 57	W-2963	78802552337	50
L-153SG	70071516531	57	W-3012	78802945549	51
L-154SG	70071516549	57	W-3013-4	78802945556	51
L-199SG	70071516556	57	W-3079	78806987653	51
L-223-2	70071092780	57	W-3094M	70071401924	51
L-225-2	70071092798	57	W-3095	78800861607	51
L-226-2	70071092806	57	W-3096	70070757086	51
L-227	70071092814	57	W-3098	78800861664	51
L-228-2	70071092822	57	W-3099	70070757094	51
L-705SG	70071516564	57, 61	W-3182-2	78805232150	51
L-705SG-F	70071534351	57	W-3281-2	70070405686	51
L-901SG	70071516572	57	W-9435-25	78800756377	50
L-905SG	70071516580	57, 61	W-9435-50	78800756336	50
L-905SG-F	70071534369	57	W-9435-100	78800857571	50
M-350	70071562022	54–55	02-0024-00	70071272697	45–47
M-985	70071562287	54–55	02-0024-01	70071272705	45–47, 56
SG-15	70071607975	49, 55	02-0690-00	70071272721	45–47, 56
SG-30W	70071606852	48–50	04-0000-21	70071272465	47, 56
SG-40W	70071606860	48–50	04-0023-02	70071621455	42–47
SG-50W	70071608155	48–49	04-0025-00	70071275344	47
SG-90	70071607983	49	04-0025-00SW	70071275351	47
V-100	70070799013	50, 52, 54	04-0026-00	70071272804	47, 56
V-111	70070799039	50	04-0067-00	70071624996	56
V-115	70070799047	50	04-0112-00	70071272812	47
V-150	70070799070	50	04-0112-00SW	70071272820	47
V-199	70071042512	48, 50	04-0116-00	70071274677	47
V-200	70070799096	50, 52	04-0116-00SW	70071274685	47
V-211	70070799112	50	04-0126-00	70071274693	47, 56
V-215	70070799120	50	04-0212-02	70071621885	47, 56
V-250	70070799146	50	04-0216-00	70071274701	47, 56
W-1449-2	78805232226	51	04-0260-00	70071274719	47, 56
W-1596	78800755627	51	04-0270-01	70071564556	47, 56
W-2119	78800860625	51	04-0270-03	70071272861	47, 56
W-2806	78806987646	51	04-0270-04	70071272879	47, 56
W-2808	70070889939	51	04-0280-00	70071272887	47, 56
W-2811-10	78800861599	51	04-0280-01	70071272895	47, 56
W-2915M	70071401916	51	04-0280-02	70071272903	47, 56
W-2916	12799462986	51	04-0290-00	70071272911	45–47, 56
W-2920	78800861631	51	04-0290-01	70071272929	45, 47, 56
W-2921	78800862167	51	04-0290-02	70071272937	45, 47, 56
W-2923	78800862324	51	04-0315-00	70071275377	47
W-2924	78806987554	51	04-0320-00	70071272945	42–47, 52–54, 56
W-2925	78801431848	51	04-0360-00	70071274727	47, 56
W-2929-25	78806986283	50	04-0361-00	70071274735	47, 56
W-2929-50	78806986291	50	04-0380-00	70071272952	47, 56
W-2929-100	78806986309	50	04-0460-00	70071274743	47, 56

Product Index

Part No	3M ID No	Page	Part No	3M ID No	Page
04-0550-00	70071403730	47	06-0300-52	70071510260	42
04-0650-00	70071272994	47	06-0300-52SW	70071510278	42
05-0000-41	70071401650	46	06-0300-55	70071621893	42, 44, 52
05-0013-00	70071624673	46	06-0400-51	70071510294	42-43, 52-53
05-0013-41	70071401726	46	06-0400-51-B	70071510567	42-43, 52-53
05-0250-00	70071401668	46	06-0400-52	70071510302	42-43, 52-53
05-0250-01	70071401676	46	06-0400-52-B	70071510575	42-43, 52-53
05-0370-00	70071401718	45-46	06-0400-53	70071510310	42-43, 52-53
05-0660-00	70071401700	45-46	06-0400-53-B	70071510534	42-43, 52-53
05-0680-00	70071534278	46	06-0400-54	70071510328	42-43, 52-54
05-0695-00	70071534302	46	06-0400-54-B	70071510591	42-43, 52-54
06-0000-10	70071510088	42-44, 52-54	06-0400-55	70071510336	42-44, 52-54
06-0000-20	70071510104	42-44, 52-54	06-0400-55-B	70071510609	42-44, 52-54
06-0000-30	70071510112	42-44, 52-54	06-0500-51	70071510344	42, 52
06-0014-00NR	70071564564	42-43, 46	06-0500-52	70071510351	42-43, 52-53
06-0100-10	70071510120	42	06-0500-53	70071510369	42, 52
06-0100-10HASV	70071564572	42, 46	06-0500-56	70071510393	42-46, 52-54, 56
06-0100-10HHSV	70071564580	42, 46	06-0500-57	70071510401	42-46, 52-54, 56
06-0100-10SW	70071510138	42	06-0500-58	70071510419	42-46, 52-54, 56
06-0100-20	70071510146	42	06-0500-59	70071510427	42-46, 52-54, 56
06-0100-20HASV	70071564598	42, 46	06-0500-65	70071621422	49
06-0100-20HHSV	70071564606	46	06-0600-00SW	70071668738	43
06-0100-20SW	70071510153	42	06-0600-10SW	70071606274	43
06-0100-30	70071510450	42	06-0600-20SW	70071606290	43
06-0100-30HASV	70071564614	42, 46	06-0600-30SW	70071606316	43
06-0100-30HHSV	70071564622	42, 46	06-0700-51	70071606332	53-54
06-0100-30SW	70071510468	42	06-0700-54	70071606340	43, 53-54
06-0200-10	70071623345	42-44, 52-54	06-0700-63	70071606357	43, 53-54
06-0200-10-B	70071623352	42-44, 52-54	06-0700-64	70071668746	43, 53-54
06-0200-20	70071623360	42-44, 52-54	06-0700-73	70071606373	43, 53-54
06-0200-20-B	70071623378	42-44, 52-54	06-0700-81	70071606431	43
06-0200-30	70071623386	42-44, 52-54	06-0700-82	70071606449	43, 53
06-0200-30-B	70071623394	42-44, 52-54	06-0700-83	70071606381	42-43, 45-47, 52-53, 56
06-0200-51	70071510187	42-44, 52-54	06-0700-85	70071606845	53
06-0200-51-B	70071510518	42-44, 52-54	07-0000-10	70071533791	45
06-0200-52	70071510195	42-44, 52-54	07-0000-11	70071533809	45
06-0200-52-B	70071510526	42-44, 52-54	07-0000-31	70071533817	45
06-0200-53	70071510203	42-44, 52-54	07-0012-00BL	70071533882	23,45
06-0200-53-B	70071510583	42-44, 52-54	07-0012-10BL	70071533700	45
06-0200-54	70071510872	42-43, 52-53	07-0012-11BL	70071533718	45
06-0200-54-B	70071510542	42-43, 52-53	07-0012-31AH	70071533775	45
06-0201-10	70071510211	42	07-0012-31BL	70071533726	45-46
06-0201-20	70071510229	42	07-0012-31BL-HA	70071564630	46
06-0201-30	70071510237	42	07-0012-31BL-HH	70071564648	46
06-0300-51	70071510245	42	07-0012-31BY	70071617750	45
06-0300-51SW	70071510252	42	07-0012-31BZ	70071533734	45

Product Index

Part No	3M ID No	Page	Part No	3M ID No	Page
07-0012-31IH	70071617776	45	34-0705-SGX	70071623642	24,48,49,57
07-0012-31RD	70071617792	45	34-0705-SGXX	70071623659	24,48,49,57
07-0012-31RS	70071617818	45	34-0905-SGV	70071623667	24,48,49,57
07-0012-31SE	70071564747	45	34-0905-SGX	70071623675	24,48,49,57
07-0012-31SJ	70071564762	45	34-0905-SGXX	70071623683	24,48,49,57
07-0012-31SR	70071564788	45	18-0099-16	70071271236	50
07-0012-31TW	70071533783	45	18-0099-40	70071271053	50
07-0012-31WP	70071564721	45	18-0099-41	70071271061	50
07-0012-31XT	70071617834	45	18-0099-42	70071271079	50
07-0014-00NR	70071564655	46	18-0099-55	70071271160	50
07-0024-02	70071534104	45-47, 56, 58	18-0099-63	70071271178	50
07-0200-51	70071533825	45	18-0099-68	70071273018	44-47, 56
07-0200-52	70071533833	45	19-0099-63	70071534385	50
07-0200-53	70071533841	45	25-0099-28	70071607678	52
07-0212-00SV	70071533858	45	25-0099-35SW	70071607660	52
07-0212-01BL	70071533866	45	25-0400-55	70071607686	52
07-0212-03BM	70071534377	45	35-1101-00SW	70071623477	28,31,38,41,48-50,52-54
07-0212-04CH	70071621414	45	35-1101-10SW	70071623410	28,31,38,41,48-50,52-54
07-0680-00	70071534096	45	35-1101-20SW	70071623428	28,31,38,41,48-50,52-54
14-0099-28	70071275385	56	35-1101-30iSW	70071688579	28,31,38,41,48-50,52-54
14-0099-29	70071275393	56	35-1101-30SW	70071623436	28,31,38,41,48-50,52-54
14-0099-32	70071275401	56	35-3301-00SW	70071623485	28,31,38,41,48-50,52-54
15-0099-05	70071268406	49	35-3301-10SW	70071623444	28,31,38,41,48-50,52-54
15-0099-06	70071268414	49	35-3301-20SW	70071623451	28,31,38,41,48-50,52-54
15-0099-08	70071268422	49	35-3301-30SW	70071623469	28,31,38,41,48-50,52-54
15-0099-10	70071268448	49	25-5401-01	70071606746	
15-0099-11	70071275013	49	25-5702-10SW	70071607603	52
15-0099-16	70071268455	49	25-5702-20SW	70071607611	52
15-0099-21	70071517778	49, 57	25-5702-30SW	70071607629	52
15-0009-99X02	70071268471	49	25-5802-10SW	70071607637	52
15-0099-99X06	70071268489	49	25-5802-20SW	70071607645	52
15-0299-99x02	70071544616	49	25-5802-30SW	70071607652	52
15-0299-99X06	70071544624	49	256-02-00	70070844074	51
15-0299-99X36	70071544632	49	256-02-01	70070884260	51
15-0499-99X02	70071608171	49	26-0099-28	70071606829	53
15-0499-99X06	70071608189	49	26-0099-35SW	70071668779	53
15-1099-07	70071268463		26-0400-55	70071606837	53
15-5401-02SG	70071516598	57	36-1101-00SW	70071623550	28,31,38,41,48-50,52-54
16-0099-27	70071274578	58	36-1101-00SWHA	70071693454	28,31,38,41,48-50,52-54
16-0099-28	70071274586	58	36-1101-10SW	70071623493	28,31,38,41,48-50,52-54
16-0099-29	70071274594	58	36-1101-20SW	70071623501	28,31,38,41,48-50,52-54
16-0099-30	70071274602	46-47, 56, 58	36-1101-30SW	70071623519	28,31,38,41,48-50,52-54
16-0099-32	70071274610	58	36-3301-00SW	70071623568	28,31,38,41,48-50,52-54
16-0099-35	70071274628	58	36-3301-10SW	70071623527	28,31,38,41,48-50,52-54
16-0300-99X05	70071274636	58	36-3301-20SW	70071623535	28,31,38,41,48-50,52-54
34-0705-SGV	70071623634	24,48,49,57	36-3301-30SW	70071623543	28,31,38,41,48-50,52-54

Product Index

Part No	3M ID No	Page
26-5702-00SW	70071670106	28,31,38,41,48-50,52-54
26-5702-30SWH	70071617610	28,31,38,41,48-50,52-54
26-5802-00SW	70071670114	28,31,38,41,48-50,52-55
27-0099-28	70071621570	54
27-0099-35SW	70071621562	54
27-0099-52	70071621588	54
27-0099-53	70071621596	54
27-0099-63	70071621604	54
27-0099-68	70071621612	54
27-0099-72	70071621620	54
27-0099-84	70071621638	54
27-0099-85	70071621745	54
37-1101-00SW	70071623600	28,31,38,41,48-50,52-54
37-1101-00SWHA	70071693462	28,31,38,41,48-50,52-54
37-1101-10SW	70071623576	28,31,38,41,48-50,52-54
37-1101-20SW	70071623584	28,31,38,41,48-50,52-54
37-1101-30SW	70071623592	28,31,38,41,48-50,52-54
27-5702-00SWSP	70071621737	28,31,38,41,48-50,52-54
27-5702-10SW	70071621505	28,31,38,41,48-50,52-54
27-5702-20SW	70071621513	28,31,38,41,48-50,52-54
27-5702-30SW	70071621521	28,31,38,41,48-50,52-54
27-5902-10SW	70071621539	28,31,38,41,48-50,52-54
27-5902-20SW	70071621547	28,31,38,41,48-50,52-54
27-5902-30SW	70071621554	28,31,38,41,48-50,52-54
529-04-49	78812400121	51
529-04-50	78812400139	51
529-05-20	78812400162	51

Where Do We Find Our Inspiration? We Learn From the Best.

Based on our extensive know-how and our long experience of welders' working conditions, we constantly emphasize innovation in developing equipment that will help increase welding efficiency. To give us your comments, and to see our latest developments, visit 3m.com/weldingsafety.



VISIT THE WORLD OF THE WELDER AT WWW.SPEEDGLAS.COM

⚠WARNING

These products meet the requirements of certain industrial eyewear standards and with some models certain industrial head protection standards. They do not provide complete head, eye, and face protection from severe impact and penetration and are not a substitute for good safety practices and engineering controls. **Misuse may result in serious injury or death.** For proper use, see supervisor refer to the product User Instructions or contact 3M Technical Service.

⚠WARNING

This product is designed to help protect the wearer's eyes and face from harmful radiation including visible light, ultra-violet radiation (UV), infra-red radiation (IR), sparks and spatter resulting from welding processes. These products must be used only by qualified persons who are properly trained in their use and maintenance. Misuse may result in permanent eye injury and vision loss. Always wear ANSI Z87.1 compliant safety spectacles in addition to any welding helmet. For proper use, see supervisor, or User Instructions or call 3M OH&ESD Technical Service in U.S.A at 1-800-243-4630 and in Canada at 1-800-267-4414.



⚠WARNING

These respirators help protect against certain airborne contaminants. Before use, the wearer must read and understand the User Instructions provided as a part of the product packaging. A written respiratory protection program must be implemented meeting all the requirements of OSHA 1910.134 including training, fit testing and medical evaluation. In Canada, CSA standards Z94.4 requirements must be met and/or requirements of the applicable jurisdiction, as appropriate. Misuse may result in sickness or death. For proper use, see User Instructions, supervisor, or call 3M OH&ESD Technical Service in USA at 1-800-243-4630 and in Canada at 1-800-267-4414.

3M, Speedglas, Adflo, E-A-R and The Power to Protect Your World are trademarks of 3M Company, used under license in Canada. PELTOR is a trademark of 3M Svenska AB, used under license in Canada. Fibre-Metal is a registered trademark of Honeywell. V-Gard® and Thermalgard® are registered trademarks of Mine Safety Appliances Co. – MSA. Jackson Safety is a registered trademark of Kimberly Clark. Bullard is a trademark of E. D. Bullard Company, used under license in Canada. TLV® is a registered trademark of the American Conference of Governmental Industrial Hygienists.



Personal Safety Division

3M Welding

3M Center, Building 235-2W-70
St. Paul, MN 55144-1000
USA
Phone 1-800-328-1667
Web www.3m.com/weldingsafety

3M PSD products are occupational use only.

 facebook.com/3MSpeedglas

 youtube.com/3MSpeedglas

 instagram.com/3MSpeedglas

For More Information

Technical Assistance in US 1-800-243-4630
Technical Assistance in Canada 1-800-267-4414
Customer Service 1-800-328-1667
Please recycle. Printed in U.S.A. ©3M 2016.
All rights reserved.
70-0716-2599-3