

DP Series • Low Cost Power Inductors

DP Series Power Inductors provide an excellent, low cost alternative to conventional chokes or inductors. Used in EMI filtering and energy storage, these compact, low radiation inductors are extremely effective in controlling AC output ripple of Switch Mode Power Supplies.

Features

- Broad range of inductance values and current ratings
- Low cost, no radiation design
- Hot Solder, pre-tinned leads for easy PC board mounting
- Operating frequency upto 100KHz
- Competitive pricing due to high volume production
- Manufactured in ISO 9001:2008, ISO/TS 16949:2009 and ISO 14001:2004 certified Talema facility
- Fully RoHS & REACH Compliant

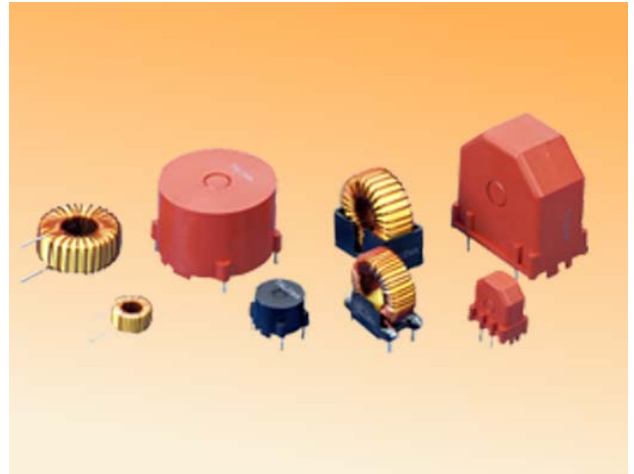

Electrical Specifications @25°C

Test frequency: Inductance measured @10KHz / 0.10Vrms
 Operating temperature: -40°C to +125°C
 Climatic category: IEC68-1 40/125/56

Applications

- Switching Power Supplies
- EMI / RFI filtering
- Output Chokes



Part Number	I _{DC} Amps	L(μH) Typ. @ Rated Current	L _O (μH) ±15% No Load	DCR (Ohms Max.)	Min. Energy Storage (μJ)*	Wire Ø (mm)	Coil Size mm OD x Ht.	Mounting Style Availability / Size			
								C	B	V	F
DP__-0.5-47	0.5	47	50	0.095	5.9	0.400	14 x 8	2	3	2	2
DP__-0.5-68		68	73	0.115	8.5	0.400	14 x 8	2	3	2	2
DP__-0.5-100		100	109	0.140	12.5	0.400	14 x 8	2	3	2	2
DP__-0.5-150		150	167	0.173	18.8	0.400	15 x 8	2	3	2	2
DP__-0.5-220		220	258	0.215	27.5	0.400	15 x 9	2	3	2	2
DP__-0.5-330		330	393	0.265	41.3	0.400	15 x 9	2	3	2	2
DP__-0.5-470		470	557	0.322	58.8	0.400	20 x 9	3	3	3	3
DP__-0.5-680		680	849	0.398	85	0.400	20 x 10	3	3	3	3
DP__-0.5-1000		1,000	1,358	0.503	125	0.400	21 x 11	3	5	4	3
DP__-0.5-1500		1,500	1,863	0.714	188	0.400	25 x 12	5	5	4	4
DP__-0.5-2200		2,200	3,131	0.926	275	0.400	25 x 12	5	5	4	4
DP__-0.5-3300		3,300	5,024	1.173	413	0.400	26 x 13	5	5	5	6
DP__-0.5-4700		4,700	6,287	1.421	588	0.400	32 x 15	5	8	5	6
DP__-1.0-22		1.0	22	23	0.041	11	0.500	14 x 8	2	3	2
DP__-1.0-33	33		37	0.052	16.5	0.500	14 x 8	2	3	2	2
DP__-1.0-47	47		53	0.063	23.5	0.500	14 x 8	2	3	2	2
DP__-1.0-68	68		80	0.077	34	0.500	14 x 8	2	3	2	2
DP__-1.0-100	100		127	0.097	50	0.500	15 x 8	2	3	2	2
DP__-1.0-150	150		207	0.123	75	0.500	15 x 9	2	3	3	2
DP__-1.0-220	220		345	0.196	110	0.450	15 x 9	2	3	3	2
DP__-1.0-330	330		491	0.193	165	0.500	20 x 9	3	3	3	3
DP__-1.0-470	470		601	0.180	235	0.600	27 x 12	5	5	5	6
DP__-1.0-680	680		891	0.220	340	0.600	27 x 13	5	5	5	6
DP__-1.0-1000	1,000		1,619	0.426	500	0.500	26 x 13	4	5	5	6
DP__-1.0-1500	1,500		2,149	0.532	750	0.500	30 x 14	5	5	5	6
DP__-1.0-2200	2,200		3,609	0.689	1100	0.500	31 x 15	5	5	6	6
DP__-1.0-3300	3,300		4,731	0.609	1650	0.600	43 x 15	--	8	--	--

Note: The μJoule rating (0.5 x LI²) is the ability of the inductor to store energy.

DP Series • Low Cost Power Inductors

Electrical Specifications @25°C

Part Number	I _{DC} Amps	L (μH) Typ. @ Rated Current	L _O (μH) ±15% No Load	DCR (Ohms Max.)	Min Energy Storage (μJ)*	Wire Ø (mm)	Coil Size mm O.D. x Ht.	Mounting Style Availability / Size			
								C	B	V	F
DP__-2.0-22	2.0	22	27	0.070	44	0.400	14 x 8	2	3	2	2
DP__-2.0-33		33	45	0.089	66	0.400	14 x 8	2	3	2	2
DP__-2.0-47		47	73	0.090	94	0.450	15 x 8	2	3	2	2
DP__-2.0-68		68	109	0.089	136	0.500	15 x 8	2	3	2	2
DP__-2.0-100		100	157	0.109	200	0.500	19 x 8	3	3	3	3
DP__-2.0-150		150	207	0.106	300	0.600	25 x 12	4	5	4	4
DP__-2.0-220		220	328	0.153	440	0.560	25 x 11	4	5	4	4
DP__-2.0-330		330	575	0.202	660	0.560	26 x 12	4	5	4	4
DP__-2.0-470		470	720	0.214	940	0.600	30 x 14	5	5	5	6
DP__-2.0-680		680	1,251	0.282	1,360	0.600	30 x 14	5	5	5	6
DP__-2.0-1000		1000	1,429	0.335	2,000	0.600	42 x 14	--	5	9	--
DP__-2.0-1500		1500	2,488	0.441	3,000	0.600	42 x 15	--	8	9	--
DP__-2.0-2200	2200	3,218	0.405	4,400	0.710	51 x 22	--	10	--	--	
DP__-3.0-15	3.0	15	21	0.039	68	0.500	14 x 8	2	3	2	2
DP__-3.0-22		22	34	0.050	99	0.500	14 x 8	2	3	2	2
DP__-3.0-33		33	49	0.038	149	0.630	19 x 8	3	3	3	3
DP__-3.0-47		47	75	0.048	212	0.630	20 x 8	3	3	3	3
DP__-3.0-68		68	92	0.060	306	0.630	25 x 12	4	5	4	4
DP__-3.0-100		100	157	0.080	458	0.630	25 x 12	4	5	4	4
DP__-3.0-150		150	256	0.107	675	0.630	25 x 12	4	5	4	4
DP__-3.0-220		220	346	0.134	990	0.630	29 x 13	5	5	5	6
DP__-3.0-330		330	625	0.142	1,485	0.710	30 x 14	5	5	5	6
DP__-3.0-470		470	727	0.187	2,115	0.670	42 x 14	--	5	9	--
DP__-3.0-680		680	1,124	0.302	3,060	.0630	42 x 16	--	8	--	--
DP__-3.0-1000		1000	1,493	0.304	4,500	0.670	49 x 20	--	10	--	--
DP__-3.0-1500		1500	2,324	0.384	6,750	0.670	53 x 24	--	11	--	--
DP__-3.0-2200		2200	4,090	0.509	9,900	0.670	54 x 26	--	11	--	--
DP__-5.0-15	5.0	15	23	0.029	188	0.600	20 x 8	3	3	3	3
DP__-5.0-22		22	28	0.039	275	0.600	25 x 12	4	5	4	4
DP__-5.0-33		33	48	0.036	413	0.710	25 x 12	4	5	4	4
DP__-5.0-47		47	82	0.043	588	0.750	25 x 12	4	5	4	4
DP__-5.0-68		68	137	0.055	850	0.750	26 x 12	4	5	4	4
DP__-5.0-100		100	172	0.059	1,250	0.800	30 x 13	5	5	5	6
DP__-5.0-150		150	221	0.094	1,875	0.710	41 x 13	--	5	9	--
DP__-5.0-220		220	381	0.097	2,750	0.800	41 x 13	--	5	9	--
DP__-5.0-330		330	475	0.156	4,125	0.710	49 x 20	--	10	--	--
DP__-5.0-470		470	852	0.187	5,875	0.750	49 x 20	--	10	--	--
DP__-5.0-680		680	1,186	0.196	8,500	0.800	53 x 25	--	11	--	--
DP__-5.0-1000		1000	2,093	0.206	12,500	0.900	55 x 26	--	11	--	--
DP__-7.5-15	7.5	15	18	0.022	422	0.750	30 x 14	5	5	5	6
DP__-7.5-22		22	30	0.025	619	0.800	30 x 14	5	5	5	6
DP__-7.5-33		33	49	0.025	928	0.900	30 x 14	5	5	5	6
DP__-7.5-47		47	84	0.026	1,322	1.000	31x 14	5	5	5	6
DP__-7.5-68		68	105	0.040	1,913	0.900	42 x 14	--	5	9	--
DP__-7.5-100		100	160	0.045	2,813	1.000	43 x 17	--	8	--	--
DP__-7.5-150		150	219	0.074	4,219	0.850	50 x 21	--	10	--	--
DP__-7.5-220		220	373	0.070	6,188	1.000	51 x 22	--	10	--	--
DP__-7.5-330		330	605	0.090	9,281	1.000	54 x 25	--	11	--	--
DP__-7.5-470		470	1,054	0.085	13,219	1.180	55 x 28	--	11	--	--

DP Series • Low Cost Power Inductors

Electrical Specifications @25°C

Part Number	I _{DC} Amps	L (μH) Typ. @ Rated Current	L _O (μH) ±15% No Load	DCR (Ohms Max.)	Min. Energy Storage (μJ)*	Wire Ø mm	Coil size mm O.D. x Ht.	Mounting Style Availability / Size			
								C	B	V	F
DP__-10-15	10	15	21	0.013	750	1.000	30 x 14	5	5	5	6
DP__-10-22		22	28	0.021	1,100	0.900	41 x 14	--	5	9	--
DP__-10-33		33	46	0.022	1,650	1.000	42 x 14	--	5	9	--
DP__-10-47		47	75	0.028	2,350	1.000	42 x 14	--	5	9	--
DP__-10-68		68	89	0.042	3,400	0.900	50 x 21	--	10	--	--
DP__-10-100		100	152	0.044	5,000	1.000	50 x 21	--	10	--	--
DP__-10-150		150	248	0.041	7,500	1.180	55 x 26	--	11	--	--
DP__-10-220		220	427	0.054	11,000	1.180	55 x 26	--	11	--	--
DP__-15-6.8	15	6.8	8	0.009	765	1.000	41 x 14	--	5	9	--
DP__-15-10		10	14	0.012	1,125	1.000	41 x 14	--	5	9	--
DP__-15-15		15	22	0.011	1,688	1.180	41 x 14	--	5	9	--
DP__-15-22		22	36	0.014	2,475	1.250	44 x 18	--	8	--	--
DP__-15-33		33	49	0.018	3,713	1.180	50 x 21	--	10	--	--
DP__-15-47		47	75	0.016	5,288	1.400	51 x 22	--	11	--	--
DP__-15-68		68	123	0.018	7,650	1.500	52 x 23	--	11	--	--
DP__-15-100		100	207	0.023	11,250	1.500	56 x 27	--	11	--	--

Talema's engineering staff can assist in the design of other inductance values and sizes.

Notes:

- 1) The μJoule rating ($0.5 \times LI^2$) is the ability of the inductor to store energy.
- 2) Inductance measured @10KHz / 0.10Vrms without DC Current, @10KHz / 0.25Vrms with DC Current.

Ordering Key

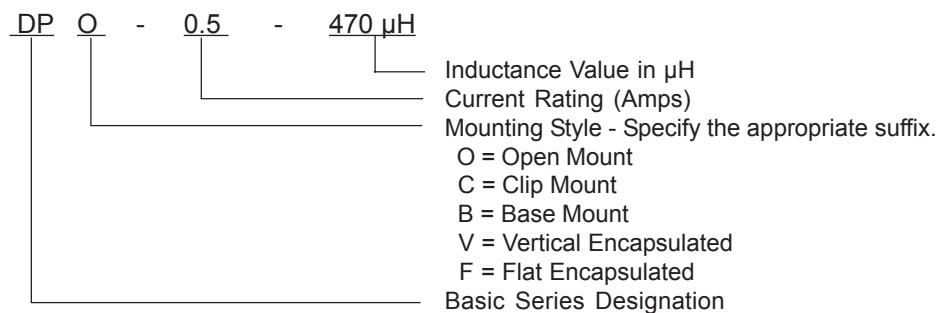

Mounting Styles • DP Series • Low Cost Power Inductors

Base Mount

Type O - Open Mount

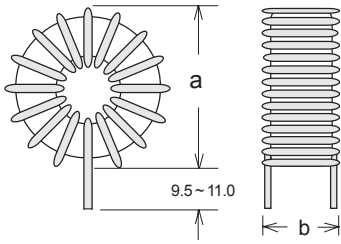

Type B- I

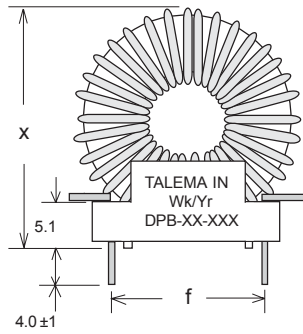

Type B-II

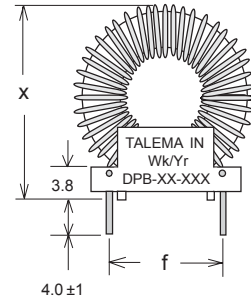

Type C - Clip Mount

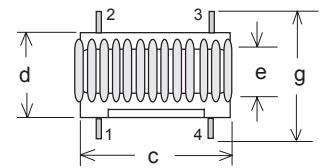
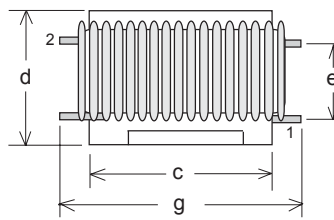
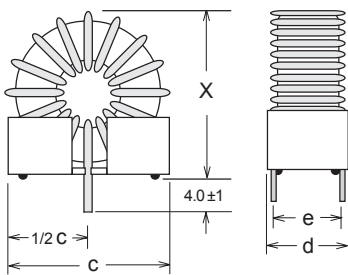

Schematic



Type V - Vertical Mount

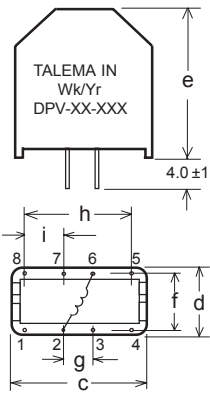

Mounting Style	Size Code	Dimensional Tolerance - Inches ± 0.010 (mm ± 0.25)								Pin \varnothing
		c	d	e	f	g	h	i	x	
"C" Clip Mount	2	16.5	11.4	7.6	--	--	--	--	Coil O.D. + 2.8	See Data Page
	3	21.0	11.4	7.6	--	--	--	--	Coil O.D. + 2.8	
	4	24.1	15.2	11.4	--	--	--	--	Coil O.D. + 2.8	
	5	31.8	17.8	12.7	--	--	--	--	Coil O.D. + 3.3	
"V" Vertical Mount	2	17.8	12.8	20.0	10.0	5.0	15.0	5.0	--	0.60 x 0.88
	3	23.0	15.5	25.0	12.5	10.0	20.0	5.0	--	0.75 x 1.10
	4	27.0	18.0	30.0	15.0	12.5	22.5	5.0	--	
	5	32.0	20.5	35.0	17.5	12.5	27.5	7.5	--	
	6	32.0	23.0	35.0	20.0	12.5	27.5	7.5	--	0.75 x 1.10
9	43.0	28.0	47.5	25.0	25.0	40.0	7.5	--	--	
"F" Flat Mount	2	17.5	17.0	12.5	10.0	15.0	--	--	--	0.60 x 0.88
	3	22.5	22.0	15.0	12.5	20.0	--	--	--	
	4	27.5	27.0	17.5	15.0	25.0	--	--	--	
	6	32.5	32.0	20.0	20.0	30.0	--	--	--	
	9	42.5	42.0	28.5	25.0	35.0	--	--	--	
Base Mount "B-I"	5	25.4	15.2	10.2	20.3	34.3	--	--	Coil O.D. + 3.5	1.27
	8	27.9	20.3	15.2	22.9	36.8	--	--		
	10	35.6	22.9	17.8	30.5	44.5	--	--		
	11	43.2	27.9	22.9	38.1	52.1	--	--		
"B-II"	3	19.1	10.8	6.4	15.2	15.9	--	--	Coil O.D. + 3.8	1.02

Type F - Flat Mount

