

Applications

- Synchronous MOSFET for Notebook Processor Power
- Synchronous Rectifier MOSFET for Isolated DC-DC Converters in Networking Systems

HEXFET® Power MOSFET

V_{DSS}	$R_{DS(on)}$ max	Qg
30V	3.3mΩ @ $V_{GS} = 10V$	34nC

Benefits

- Very low $R_{DS(ON)}$ at 4.5V V_{GS}
- Low Gate Charge
- Fully Characterized Avalanche Voltage and Current
- 100% Tested for R_G
- Lead-Free (Qualified up to 260°C Reflow)
- RoHS compliant (Halogen Free)
- Low Thermal Resistance
- Large Source Lead for more reliable Soldering

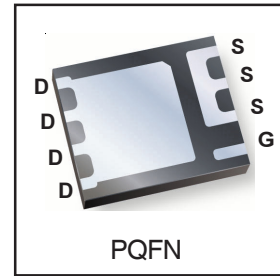
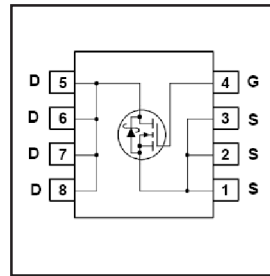

Orderable part number	Package Type	Standard Pack		Note
		Form	Quantity	
IRFH7932TRPbF	PQFN 5mm x 6mm	Tape and Reel	4000	
IRFH7932TR2PbF	PQFN 5mm x 6mm	Tape and Reel	400	EOL notice # 259

Absolute Maximum Ratings

	Parameter	Max.	Units
V_{DS}	Drain-to-Source Voltage	30	V
V_{GS}	Gate-to-Source Voltage	± 20	
$I_D @ T_A = 25^\circ C$	Continuous Drain Current, $V_{GS} @ 10V$	25	A
$I_D @ T_A = 70^\circ C$	Continuous Drain Current, $V_{GS} @ 10V$	20	
$I_D @ T_C = 25^\circ C$	Continuous Drain Current, $V_{GS} @ 10V$	104	
I_{DM}	Pulsed Drain Current ①	200	
$P_D @ T_A = 25^\circ C$	Power Dissipation ②	3.4	W
$P_D @ T_A = 70^\circ C$	Power Dissipation ②	2.2	
	Linear Derating Factor ③	0.03	W/°C
T_J	Operating Junction and	-55 to + 150	°C
T_{STG}	Storage Temperature Range		

Thermal Resistance

	Parameter	Typ.	Max.	Units
$R_{\theta JC}$	Junction-to-Case ④	—	2.2	°C/W
$R_{\theta JA}$	Junction-to-Ambient ⑤	—	37	

Notes ① through ⑤ are on page 10

Static @ T_J = 25°C (unless otherwise specified)

	Parameter	Min.	Typ.	Max.	Units	Conditions
BV _{DSS}	Drain-to-Source Breakdown Voltage	30	—	—	V	V _{GS} = 0V, I _D = 250μA
ΔBV _{DSS} /ΔT _J	Breakdown Voltage Temp. Coefficient	—	0.021	—	V/°C	Reference to 25°C, I _D = 1mA
R _{DS(on)}	Static Drain-to-Source On-Resistance	—	2.5	3.3	mΩ	V _{GS} = 10V, I _D = 25A ③
		—	3.3	3.9		V _{GS} = 4.5V, I _D = 20A ③
V _{GS(th)}	Gate Threshold Voltage	1.35	1.8	2.35	V	V _{DS} = V _{GS} , I _D = 100μA
ΔV _{GS(th)}	Gate Threshold Voltage Coefficient	—	-5.9	—	mV/°C	
I _{DSS}	Drain-to-Source Leakage Current	—	—	1.0	μA	V _{DS} = 24V, V _{GS} = 0V
		—	—	150		V _{DS} = 24V, V _{GS} = 0V, T _J = 125°C
I _{GSS}	Gate-to-Source Forward Leakage	—	—	100	nA	V _{GS} = 20V
	Gate-to-Source Reverse Leakage	—	—	-100		V _{GS} = -20V
g _{fs}	Forward Transconductance	59	—	—	S	V _{DS} = 15V, I _D = 20A
Q _g	Total Gate Charge	—	34	51	nC	V _{DS} = 15V V _{GS} = 4.5V I _D = 20A See Fig.17 & 18
Q _{gs1}	Pre-V _{th} Gate-to-Source Charge	—	7.9	—		
Q _{gs2}	Post-V _{th} Gate-to-Source Charge	—	3.6	—		
Q _{gd}	Gate-to-Drain Charge	—	11	—		
Q _{godr}	Gate Charge Overdrive	—	12	—		
Q _{sw}	Switch Charge (Q _{gs2} + Q _{gd})	—	15	—		
Q _{oss}	Output Charge	—	19	—	nC	V _{DS} = 16V, V _{GS} = 0V
R _G	Gate Resistance	—	0.7	—	Ω	
t _{d(on)}	Turn-On Delay Time	—	20	—	ns	V _{DD} = 15V, V _{GS} = 4.5V I _D = 20A R _G = 1.8Ω See Fig.15
t _r	Rise Time	—	48	—		
t _{d(off)}	Turn-Off Delay Time	—	23	—		
t _f	Fall Time	—	20	—		
C _{iss}	Input Capacitance	—	4270	—	pF	V _{GS} = 0V V _{DS} = 15V f = 1.0MHz
C _{oss}	Output Capacitance	—	830	—		
C _{rss}	Reverse Transfer Capacitance	—	420	—		

Avalanche Characteristics

	Parameter	Typ.	Max.	Units
E _{AS}	Single Pulse Avalanche Energy ②	—	16	mJ
I _{AR}	Avalanche Current ①	—	20	A

Diode Characteristics

	Parameter	Min.	Typ.	Max.	Units	Conditions
I _S	Continuous Source Current (Body Diode)	—	—	4.2	A	MOSFET symbol showing the integral reverse p-n junction diode.
I _{SM}	Pulsed Source Current (Body Diode) ①	—	—	200		
V _{SD}	Diode Forward Voltage	—	—	1.0	V	T _J = 25°C, I _S = 20A, V _{GS} = 0V ③
t _{rr}	Reverse Recovery Time	—	21	32	ns	T _J = 25°C, I _F = 20A, V _{DD} = 15V
Q _{rr}	Reverse Recovery Charge	—	33	50	nC	di/dt = 300A/μs ③ See Fig.16
t _{on}	Forward Turn-On Time	Intrinsic turn-on time is negligible (turn-on is dominated by LS+LD)				

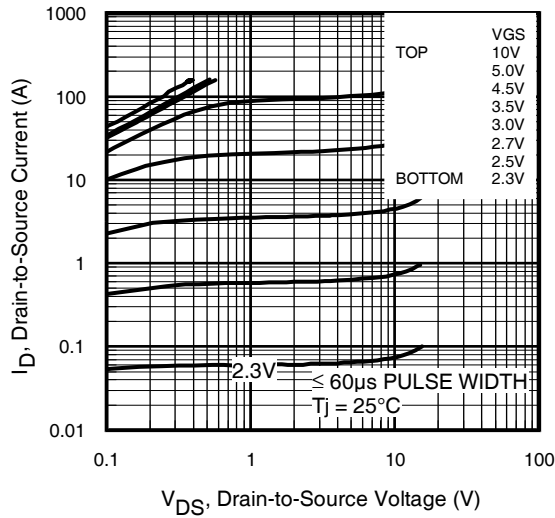
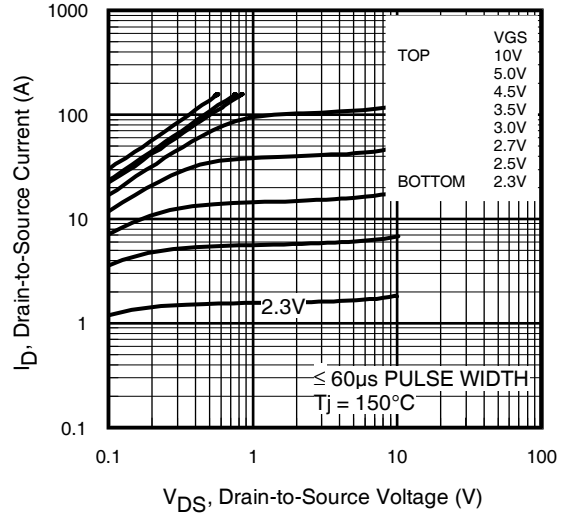
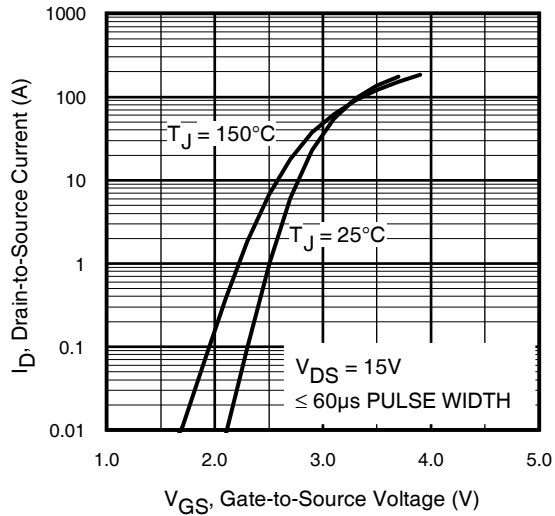
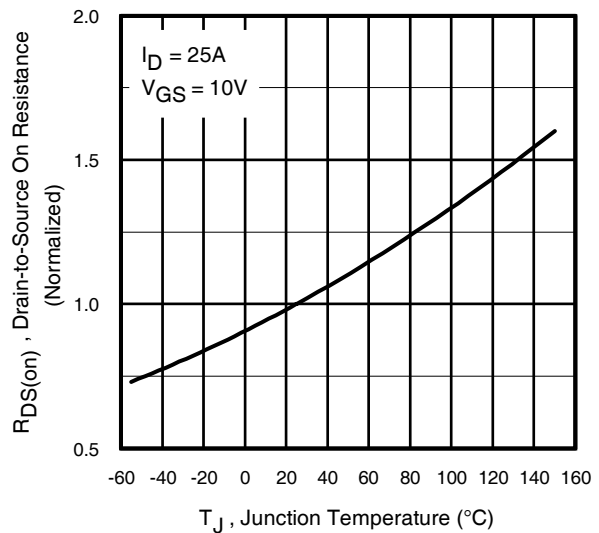
Fig 1. Typical Output Characteristics

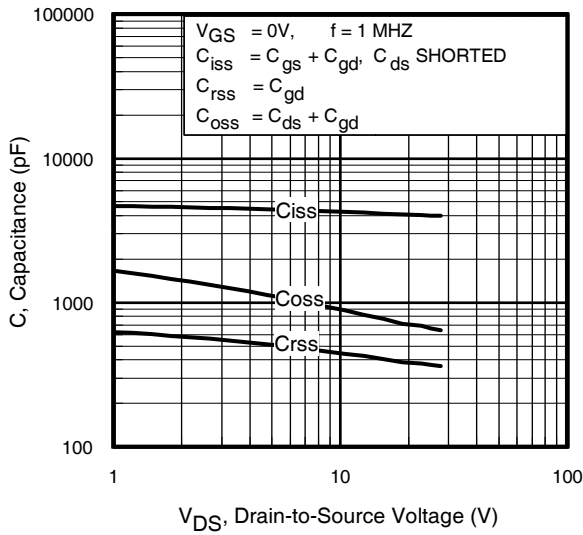
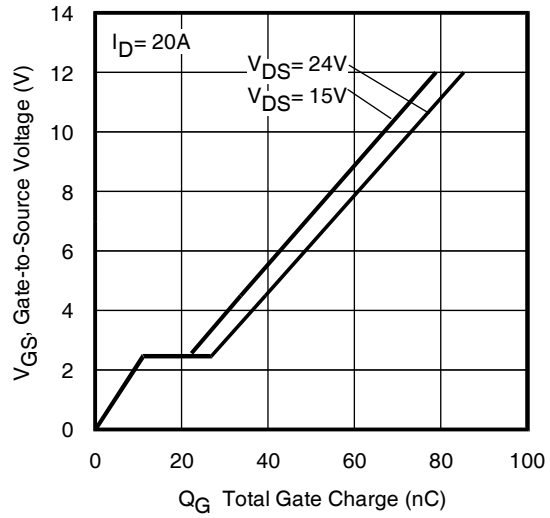
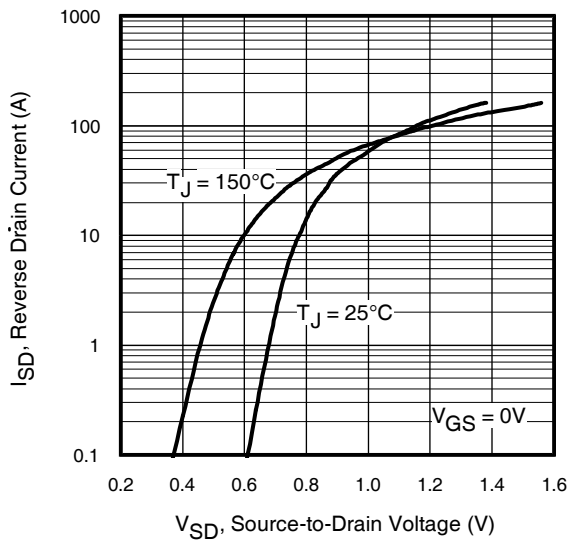
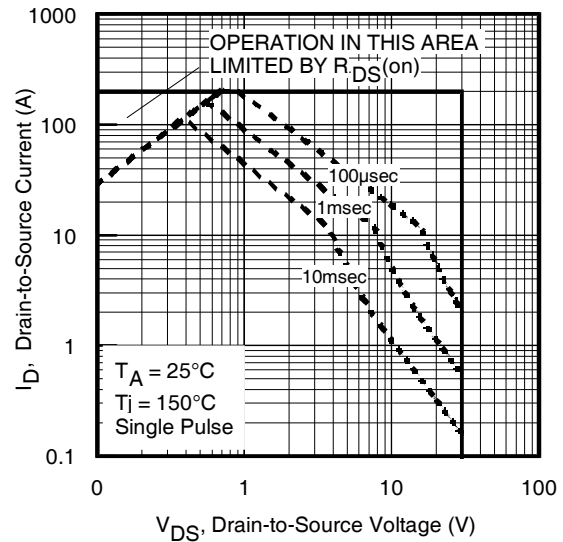
Fig 2. Typical Output Characteristics

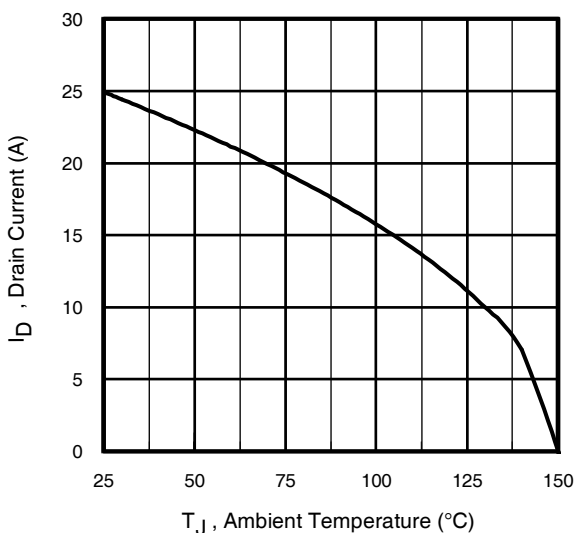
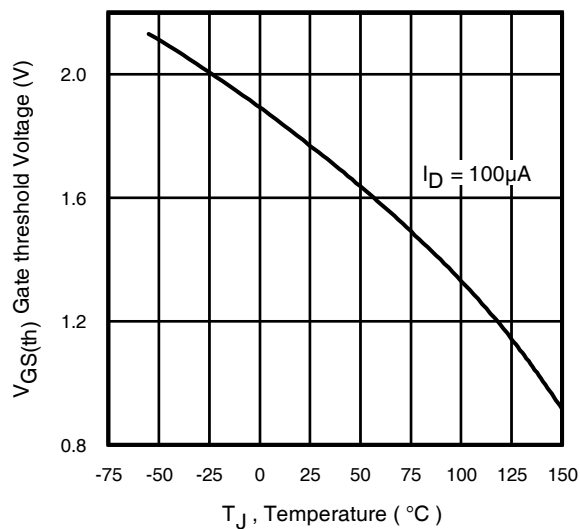
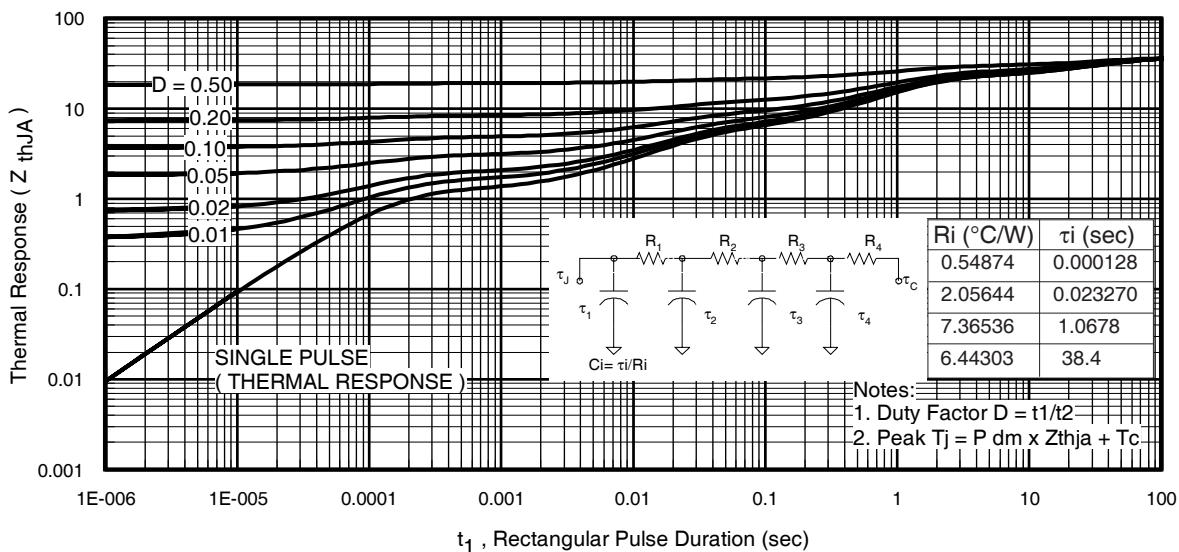
Fig 3. Typical Transfer Characteristics

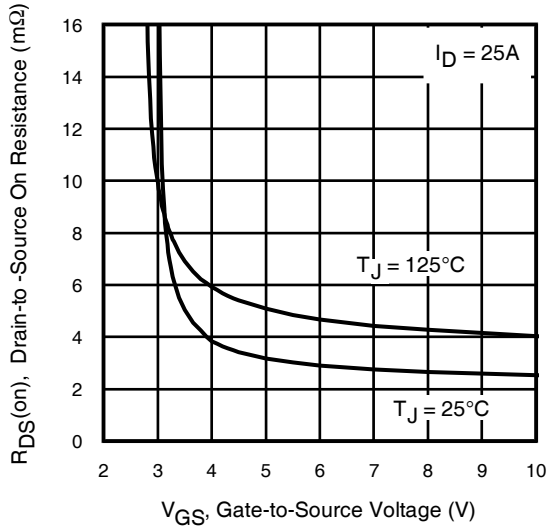
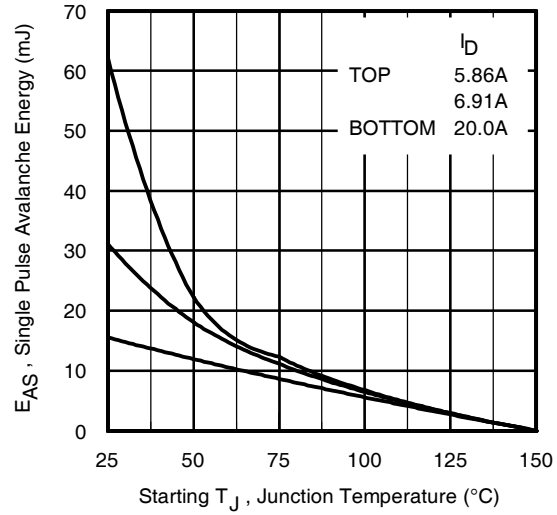
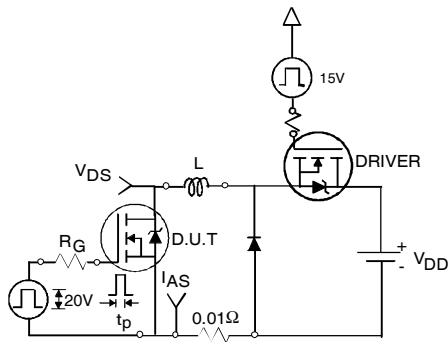
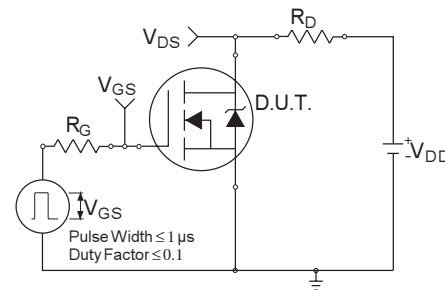
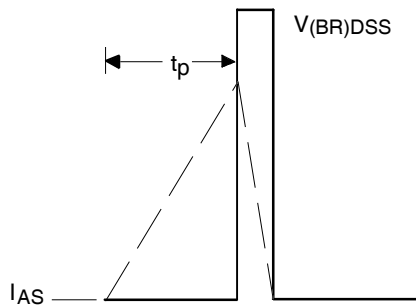
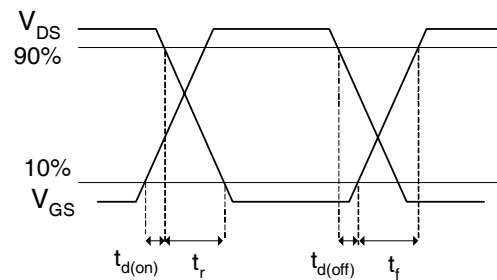
Fig 4. Normalized On-Resistance Vs. Temperature

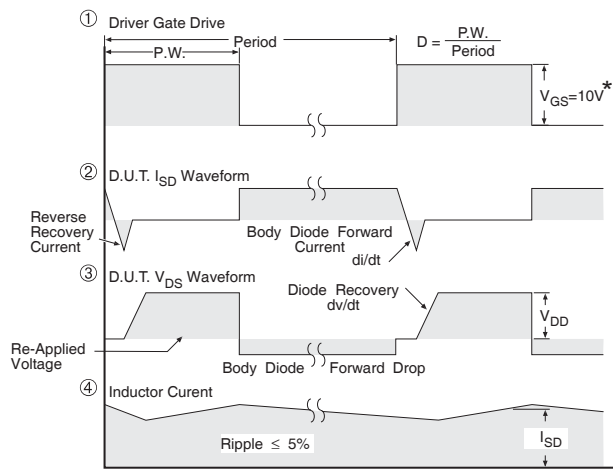
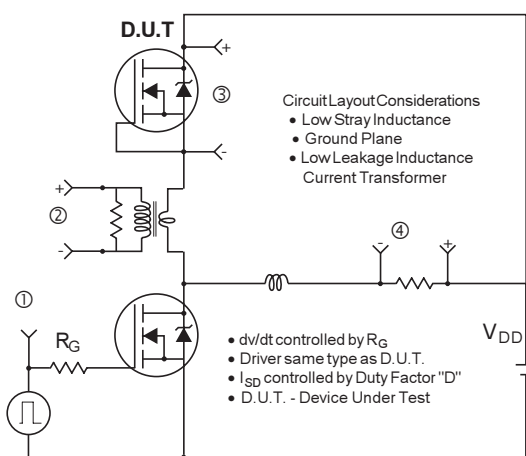
Fig 5. Typical Capacitance Vs. Drain-to-Source Voltage

Fig 6. Typical Gate Charge Vs. Gate-to-Source Voltage

Fig 7. Typical Source-Drain Diode Forward Voltage

Fig 8. Maximum Safe Operating Area

Fig 9. Maximum Drain Current Vs. Ambient Temperature

Fig 10. Threshold Voltage Vs. Temperature

Fig 11. Maximum Effective Transient Thermal Impedance, Junction-to-Ambient

Fig 12. On-Resistance vs. Gate Voltage

Fig 13. Maximum Avalanche Energy vs. Drain Current

Fig 14a. Unclamped Inductive Test Circuit

Fig 15a. Switching Time Test Circuit

Fig 14b. Unclamped Inductive Waveforms

Fig 15b. Switching Time Waveforms



* $V_{GS} = 5V$ for Logic Level Devices

Fig 16. Peak Diode Recovery dv/dt Test Circuit for N-Channel HEXFET® Power MOSFETs

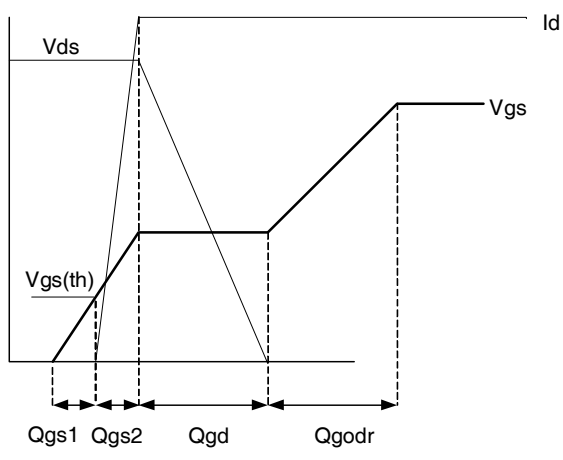
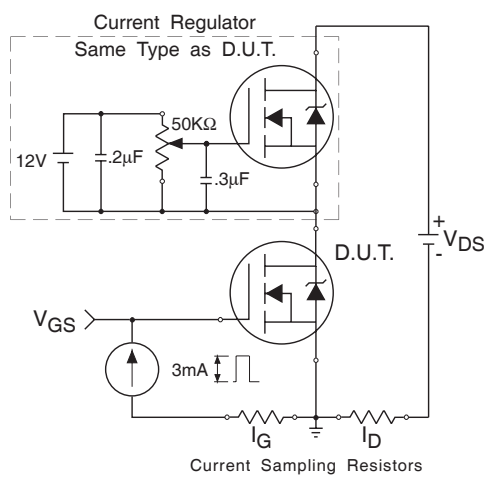
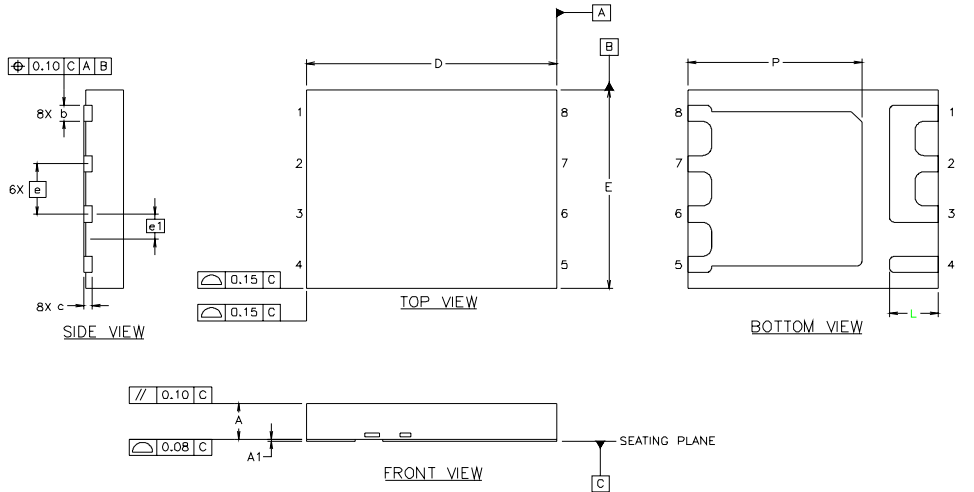

Fig 17. Gate Charge Test Circuit

Fig 18. Gate Charge Waveform

PQFN Package Details



DIM	INCHES		MILLIMETERS	
	MIN	MAX	MIN	MAX
A	.0315	.0394	0.800	1.000
A1	.0000	.0020	0.000	0.050
b	.0140	.0180	0.356	0.456
c	.0080	REF.	0.203	REF.
D	.2323	.2402	5.900	6.100
E	.1929	.2008	4.900	5.100
e	.0500	BASIC	1.270	BASIC
e1	.0250	BASIC	0.635	BASIC
L	.0443	.0482	1.125	1.225
P	.1620	.1659	4.115	4.215

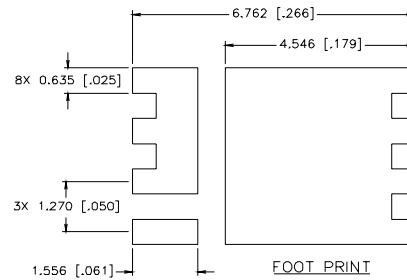

PQFN Part Marking

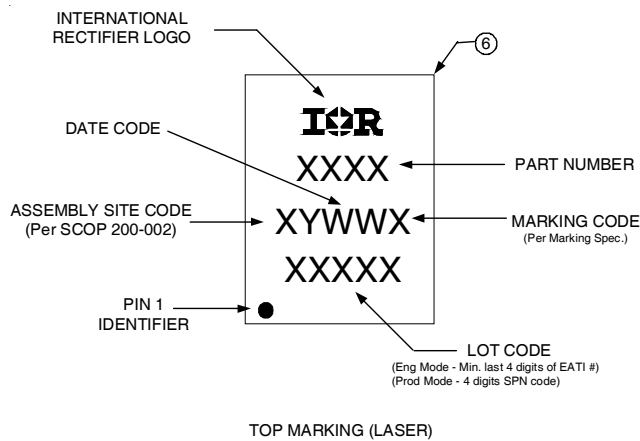

Note: For the most current drawing please refer to IR website at: <http://www.irf.com/package/>

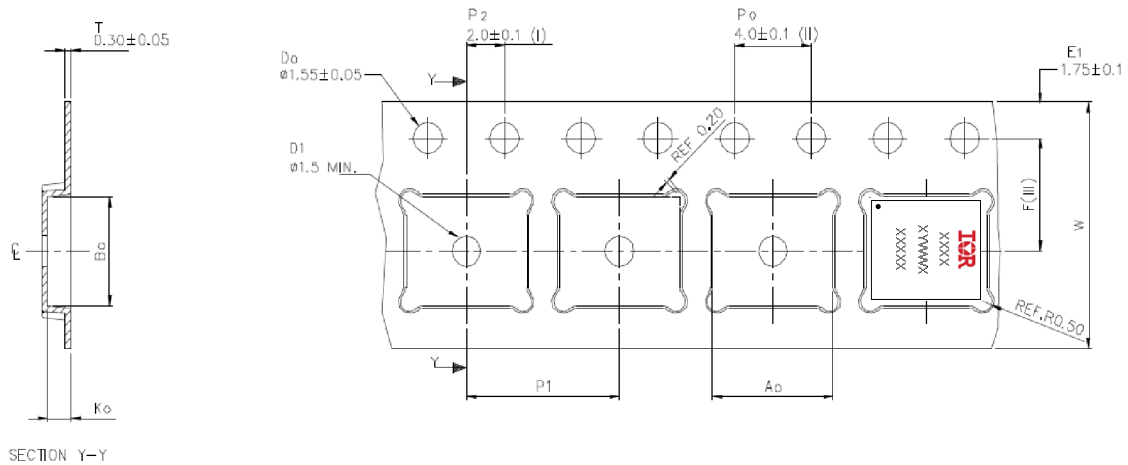
PQFN Tape and Reel

A_0	6.30 ± 0.1
B_0	5.30 ± 0.1
K_0	1.20 ± 0.1
F	5.50 ± 0.1
P_1	8.00 ± 0.1
W	12.00 ± 0.3

- (I) Measured from centreline of sprocket hole to centreline of pocket.
- (II) Cumulative tolerance of 10 sprocket holes is ± 0.20 .
- (III) Measured from centreline of sprocket hole to centreline of pocket.
- (IV) Other material available.
- (V) Typical SR of form tape Max 10^9 OHM/SQ

ALL DIMENSIONS IN MILLIMETRES UNLESS OTHERWISE STATED.

Qualification Information[†]

Qualification level	Consumer ^{††} (per JEDEC JESD47F ^{†††} guidelines)	
Moisture Sensitivity Level	SO-8	MSL1 (per JEDEC J-STD-020D ^{†††})
RoHS Compliant	Yes	

- † Qualification standards can be found at International Rectifier's web site
<http://www.irf.com/product-info/reliability>
- †† Higher qualification ratings may be available should the user have such requirements.
 Please contact your International Rectifier sales representative for further information:
<http://www.irf.com/whoto-call/salesrep/>
- ††† Applicable version of JEDEC standard at the time of product release.

Notes:

- ① Repetitive rating; pulse width limited by max. junction temperature.
- ② Starting $T_J = 25^\circ\text{C}$, $L = 0.078\text{mH}$, $R_G = 25\Omega$, $I_{AS} = 20\text{A}$.
- ③ Pulse width $\leq 400\mu\text{s}$; duty cycle $\leq 2\%$.
- ④ R_{thjc} is guaranteed by design
- ⑤ When mounted on 1 inch square 2 oz copper pad on 1.5x1.5 in. board of FR-4 material.

Revision History

Date	Comments
12/16/2013	<ul style="list-style-type: none"> • Updated ordering information to reflect the End-Of-life (EOL) of the mini-reel option (EOL notice #259) • Updated data sheet with new IR corporate template
8/1/2014	<ul style="list-style-type: none"> • Updated data sheet with PQFN Tape and Reel Diagram from Datasheet IRFH7934PbF