



■ Rolling blind



■ Electrical distribution



■ PCB applications



Microswitches

subminiature

V4D

Microswitches subminiature V4D

Crouzet Presentation

■ Adaptation	p. 3
■ Customisation is our business	p. 4
■ V4D Advantages	p. 5
■ Ordering information	p. 5
■ Basic technical principles	p. 5
■ Main specifications	p. 6
■ Additional specifications	p. 6
■ Principle	p. 7
■ Dimensions	p. 7
■ Product adaptations	p. 7
■ Connections	p. 8
■ Actuators	p. 8
■ Mechanical characteristics with actuators	p.10
■ Mounting-Operation	p.10
■ Selection guide	p.11

Crouzet has been a recognised supplier of quality position sensors, micro-switches and limit switches for more than 30 years. Today, **Crouzet** offers you a new range of micro-switches designed to fulfill the toughest of OEMs' requirements.

To suit your design requirements, Crouzet continues to develop its capabilities as a specialist in customisation, offering you solutions specifically adapted to all your applications. Because our top most priority is nothing be left to chance, our quality and environmental management systems are certified to ISO 9001 and ISO 14001.

About Custom Sensors & Technologies



Headquartered in Moorpark, CA - Custom Sensors & Technologies (CST) is comprised of industry-leading brands including Crouzet, Kavlico, Crydom, and former divisions of BEI Technologies – Newall and Systron Donner. CST provides sensors, controls, and actuation products for the Transportation, Industrial and Aerospace & Defense markets.



Crouzet

Adaptation

To meet the growing demand for customisation, Crouzet's expertise in terms of adapting products and their corresponding accessories is available to all customers.

Crouzet can customise its products for use in any type of environment or application to ensure perfect integration into any equipment.

Because quality is at the heart of our approach, our quality control and our environmental management system are certified to ISO 9001 and ISO 14001 respectively.

■ All our expertise in sensing design and industrialisation placed at your service, to respond to a **specific need** dedicated to your application.

■ A complete range of **standard microswitches** available immediately to create your sensing application.

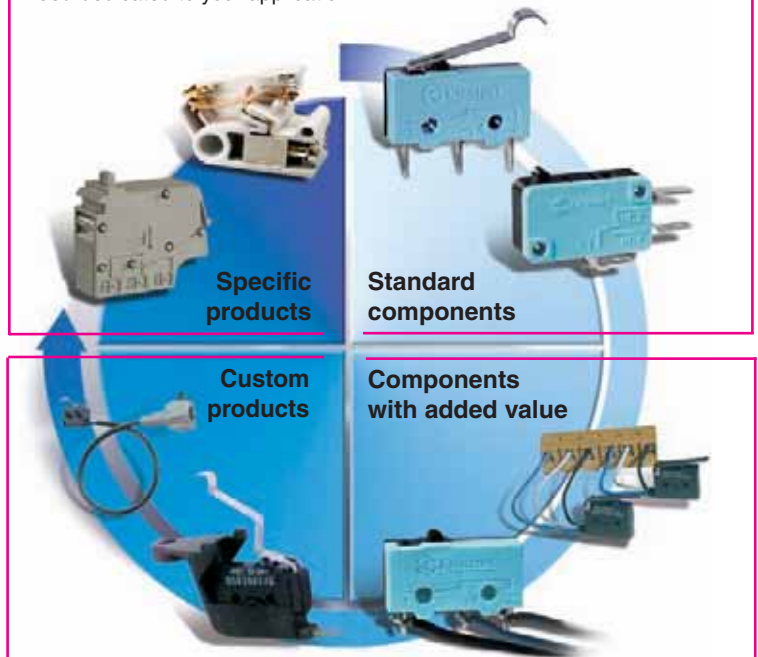

■ Defined in coordination with our technical sales teams, these custom products have the corresponding performance and functionality.

■ Standard products complemented by factory-mounted auxiliaries or accessories (levers, cables, connectors, etc) in order to assist integration in your equipment, simplify your logistics and maximise the reliability of your installation.

Crouzet

Process



■ Customer needs



■ R&D department



■ Production



■ Quality

Microswitches subminiature V4D

Crouzet

Customisation is our business

□ Control devices

Even more adaptation for easier actuating

Special button shapes which compensate for any faults or positioning drift of the control actuator.



□ Connections

A complete electrical function

Special connectors, customised wiring, customer bundles, dedicated terminals...



□ Seals

Even more solutions for demanding environments

Numerous components available to provide effective protection for your contacts, including caps, boot seals, membranes, sealing resin, wiper seals.



□ Special levers

Obtain the control data

Angled, curved, extended or retractable... these special lever types can be used to extend the control device for easier adjustment, increase the operating force, resist high actuation torque or provide totally safe electrical isolation.



□ Special contacts

The right contact for every environment

High or low current, AC or DC, type of load (inductive or resistive), industrial or corrosive atmosphere, occasional or intensive use. The best metals, silver, silver nickel, silver palladium, gold-plated silver, solid gold.



□ Special fixings

No effort is spared to make mounting easier

Snap-on fixing, screw-fixing, crimping or pins are just a few examples of the numerous solutions available to meet all your requirements.



V4D Advantages

- Wide range of switching ratings from 0.1 A to 12 A
- V4 standard size
- Approved to ENEC (EN 61058-1) and UL/CSA
- Compliant to RoHS
- Glow wire test withstanding to EN 60335-1: GWFI 850°C and GWIT 775°C
- Various applications areas: Industry, Consumer equipment, Home appliances, HVAC, ...
- A high capacity to adapt levers, connections, fixing elements, upon request



Ordering Information

Model Number Legend

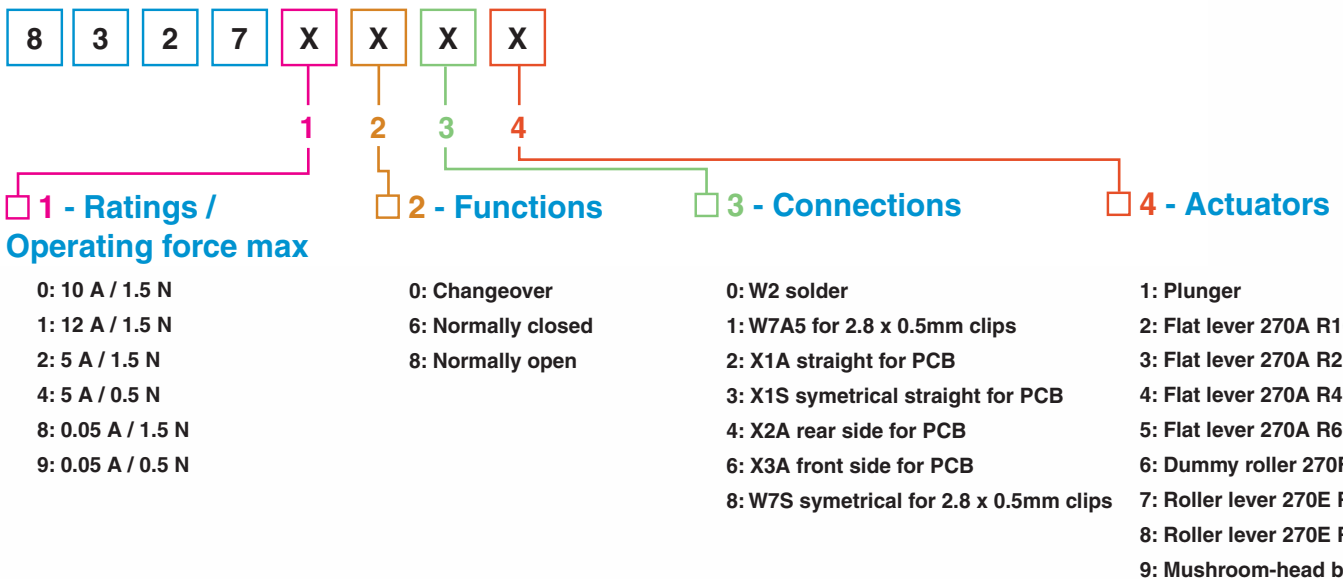

Basic technical principles

■ See our Position Sensors Catalogue

Microswitches subminiature V4D

- Nominal ratings from 0.1 A to 12 A
- Operating temperature up to + 150°C
- Approved to ENEC and UL/CSA
- Large choice of actuators



Main specifications

		83270	83271	83272	83274
Function	Connections				
I (changeover)	W2 - W7A5 - W7S - X1A X1S- X2A - X3A	●	●	●	●
R (normally closed)	W2 - W7A5	●	●	●	●
C (normally open)	W2 - W7A5	●	●	●	●
Electrical characteristics					
Rating nominal / 250 V AC (A)		10	12	5	5
Rating thermal / 250 V AC (A)		12	15	6	6
Rating nominal / 5 → 24 V AC/DC (A)		-	-	-	-
Mechanical characteristics					
Maximum operating force (N)		1.5	1.5	1.5	0.5
Min. Release force (N)		0.3	0.3	0.3	0.1
Maximum total travel force (N)		2	2	2	1
Max. permitted overtravel force (N)		10	10	10	10
Maximum rest position (mm)		9.2*	9.2*	9.2*	9.2*
Tripping point (mm)		8.4 ^{±0.3} **	8.4 ^{±0.3} **	8.4 ^{±0.3} **	8.4 ^{±0.3} **
Maximum differential travel (mm)		0.15	0.15	0.15	0.15
Min. overtravel (mm)		0.5	0.5	0.5	0.5
Ambient operating temperature (°C)		-20 → +85	-20 → +85	-20 → +125	-20 → +125
Mechanical life for 2/3 OT (operations)		500 000	500 000	500 000	1 000 000
Contact gap (mm)		0.4	0.4	0.4	0.4
Weight (g)		2	2	2	2
Approvals					
EN 61058-1	Rating for T 85° C # T 125° C ## T 150° C	10 (2) A 250 V AC	12 (6) A 250 V AC	# 5 (1) A 250 V AC	# 5 (1) A 250 V AC
	Number of cycles	10 000	10 000	50 000	50 000
UL 1054	Rating	10.1 A 1/4 HP 125.250 V AC	12 A 125.250 V AC (contact us)	5 A 125.250 V AC 1/4 HP 250 V AC	5 A 125.250 V AC 1/4 HP 250 V AC
	Number of cycles	6 000	6 000	6 000	6 000
Comments					

* 10.8 for mushroom head button

** 9.9 ± 0.3 for mushroom head button

Additional specifications

Component Materials

- Housing/cover/button: polyester UL 94V0-GWIT 775°C / GWFI 850°C
- Contacts: silver alloy or gold plated
- Terminals : silver-plated brass
- Actuators: stainless steel, glass filled polyamide roller

Principle

Single break changeover switch

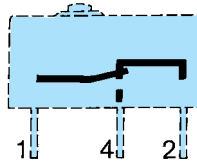

Dimensions (mm)

83278	83279
●	●
●	●
●	●
-	-
-	-
0.001 → 0.05	0.001 → 0.05
1.5	0.5
0.3	0.1
2	1
10	10
9.2**	9.2**
8.4±0.3***	8.4±0.3***
0.15	0.15
0.5	0.5
-20 → +150	-20 → +150
500 000	1 000 000
0.4	0.4
2	2
## 0.1 (0.04) A 250 V AC	## 0.1 (0.04) A 250 V AC
50 000	50 000
0.1 A 125 V AC	0.1 A 125 V AC
6 000	6 000

Asymmetrical version

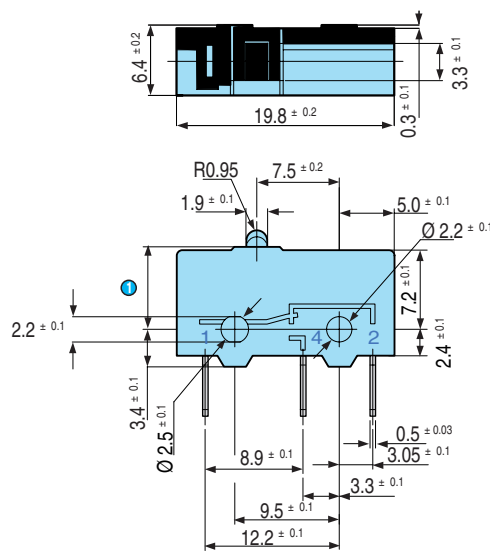

① Total Travel Position = 7.6 Max.

Mushroom-head button

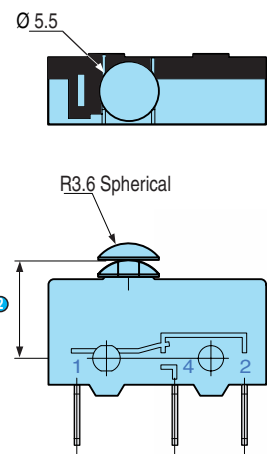

② Total Travel Position = 9.1 Max.

Symmetrical version

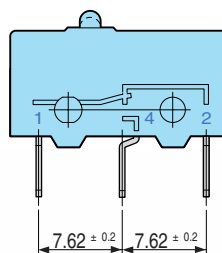

Product adaptations



- Special levers
- Special connections
- Specific fixing
- High operating temperature
- 2.35 mm diameter fixing holes

Microswitches subminiature V4D

Connections

W2

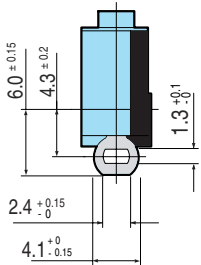

W7A5 / W7S

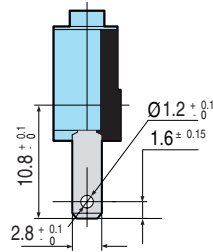

X1A / X1S

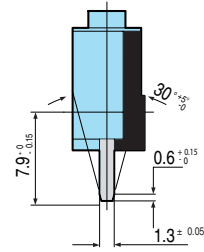

X2A / X2S

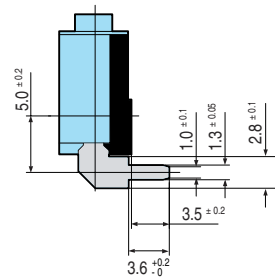

X3A / X3S

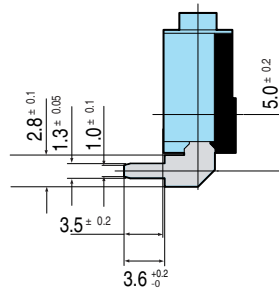

Actuators

→ Levers

270 A

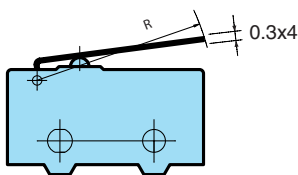

270 F

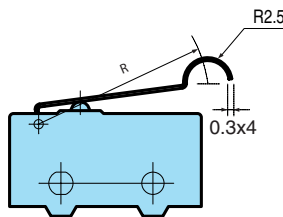

270 E

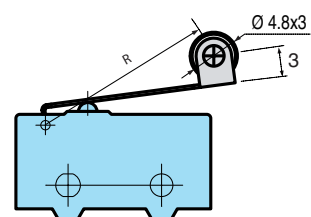

Actuator mounting position

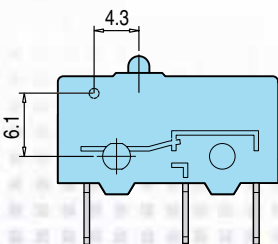

Mechanical characteristics with actuators

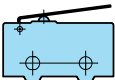
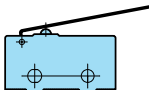
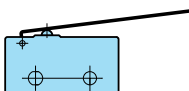
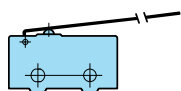
		Length of actuator (mm)	Maximum operating force (N)	Minimum release force (N)	Tripping point (mm)	Minimum overtravel (mm)	Maximum differential travel (mm)	Maximum total travel (mm)
 <p>Lever 270A R16.8</p>	83270	16.8	0.5	0.09	9.7 \pm 1.4	0.8	0.6	5.5
	83271	16.8	0.5	0.09	9.7 \pm 1.4	0.8	0.6	5.5
	83272	16.8	0.5	0.09	9.7 \pm 1.4	0.8	0.6	5.5
	83274	16.8	0.16	0.03	10 \pm 1.4	1.1	0.5	5.5
	83278	16.8	0.5	0.09	9.7 \pm 1.4	0.8	0.6	5.5
	83279	16.8	0.16	0.03	10 \pm 1.4	1.1	0.5	5.5
 <p>Lever 270A R22.5</p>	83270	22.5	0.35	0.06	10.1 \pm 1.7	1.2	1.1	7
	83271	22.5	0.35	0.06	10.1 \pm 1.7	1.2	1.1	7
	83272	22.5	0.35	0.06	10.1 \pm 1.7	1.2	1.1	7
	83274	22.5	0.12	0.02	10.6 \pm 1.7	1.7	0.7	7
	83278	22.5	0.35	0.06	10.1 \pm 1.7	1.2	1.1	7
	83279	22.5	0.12	0.02	10.6 \pm 1.7	1.7	0.7	7
 <p>Lever 270A R41</p>	83270	41	0.20	0.03	11.1 \pm 3	3.1	2.1	15
	83271	41	0.20	0.03	11.1 \pm 3	3.1	2.1	15
	83272	41	0.20	0.03	11.1 \pm 3	3.1	2.1	15
	83274	41	0.07	0.01	12.4 \pm 3	4.4	1.4	15
	83278	41	0.20	0.03	11.1 \pm 3	3.1	2.1	15
	83279	41	0.07	0.01	12.4 \pm 3	4.4	1.4	15
 <p>Lever 270A R60</p>	83270	60	0.13	0.02	11.6 \pm 5	3.6	3.5	23
	83271	60	0.13	0.02	11.6 \pm 5	3.6	3.5	23
	83272	60	0.13	0.02	11.6 \pm 5	3.6	3.5	23
	83274	60	0.05	0.01	14 \pm 5	6	2.3	23
	83278	60	0.13	0.02	11.6 \pm 5	3.6	3.5	23
	83279	60	0.05	0.01	14 \pm 5	6	2.3	23

Microswitches subminiature V4D

Mechanical characteristics with actuators

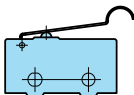
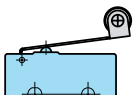
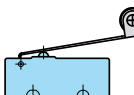
		Length of actuator (mm)	Maximum operating force (N)	Minimum release force (N)	Tripping point (mm)	Minimum overtravel (mm)	Maximum differential travel (mm)	Maximum total travel (mm)
 <p>Lever 270F R18</p>	83270	18	0.45	0.08	12.6 \pm 1.5	0.8	0.7	6
	83271	18	0.45	0.08	12.6 \pm 1.5	0.8	0.7	6
	83272	18	0.45	0.08	12.6 \pm 1.5	0.8	0.7	6
	83274	18	0.15	0.03	12.9 \pm 1.5	1.1	0.6	6
	83278	18	0.45	0.08	12.6 \pm 1.5	0.8	0.7	6
	83279	18	0.15	0.03	12.9 \pm 1.5	1.1	0.6	6
 <p>Lever 270E R18.5</p>	83270	18.5	0.45	0.08	15.2 \pm 1.4	0.9	0.7	6
	83271	18.5	0.45	0.08	15.2 \pm 1.4	0.9	0.7	6
	83272	18.5	0.45	0.08	15.2 \pm 1.4	0.9	0.7	6
	83274	18.5	0.15	0.03	15.5 \pm 1.4	1.2	0.6	6
	83278	18.5	0.45	0.08	15.2 \pm 1.4	0.9	0.7	6
	83279	18.5	0.15	0.03	15.5 \pm 1.4	1.2	0.6	6
 <p>Lever 270E R24.1</p>	83270	24.1	0.35	0.06	15.7 \pm 1.8	1.3	1.2	8
	83271	24.1	0.35	0.06	15.7 \pm 1.8	1.3	1.2	8
	83272	24.1	0.35	0.06	15.7 \pm 1.8	1.3	1.2	8
	83274	24.1	0.12	0.02	16.2 \pm 1.8	1.8	0.8	8
	83278	24.1	0.35	0.06	15.7 \pm 1.8	1.3	1.2	8
	83279	24.1	0.12	0.02	16.2 \pm 1.8	1.8	0.8	8

Mounting - Operation

To conform to the leakage paths and air gaps required in the standard EN/IEC 61058-1 - EN/IEC 60947-5-1:

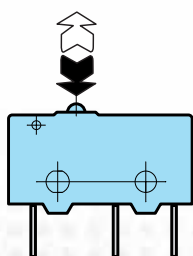

- An insulation pad must be inserted between the microswitch and the fixing surface if the fixing surface is metal.
 - Manual operation of a metal actuator must only be carried out with the help of a secondary actuator made of insulating material.
- The installer must ensure adequate protection against direct contact with the output terminals.

Selection guide

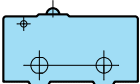
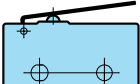
			Rating / Force		10 A / 1.5 N	12 A / 1.5 N	5 A / 1.5 N	5 A / 0.5 N	0.05 A / 1.5 N	0.05 A / 0.5 N	
			Type		83270	83271	83272	83274	83278	83279	
Actuators	Function	Connection									
 <p>Plunger</p>	I	W2	83270001	83271001	83272001	83274001	83278001	83279001			
	I	W7A5	83270011	83271011	83272011	83274011	83278011	83279011			
	I	X1A	83270021	83271021	83272021	83274021	83278021	83279021			
	I	X1S	83270031	83271031	83272031	83274031	83278031	83279031			
	I	X2A	83270041	83271041	83272041	83274041	83278041	83279041			
	I	X3A	83270061	83271061	83272061	83274061	83278061	83279061			
	I	W7S	83270081	83271081	83272081	83274081	83278081	83279081			
	R	W2	83270601	83271601	83272601	83274601	83278601	83279601			
	R	W7A5	83270611	83271611	83272611	83274611	83278611	83279611			
	C	W2	83270801	83271801	83272801	83274801	83278801	83279801			
	C	W7A5	83270811	83271811	83272811	83274811	83278811	83279811			
	 <p>Lever 270A R16.8</p>	I	W2	83270002	83271002	83272002	83274002	83278002	83279002		
		I	W7A5	83270012	83271012	83272012	83274012	83278012	83279012		
		I	X1A	83270022	83271022	83272022	83274022	83278022	83279022		
I		X1S	83270032	83271032	83272032	83274032	83278032	83279032			
I		X2A	83270042	83271042	83272042	83274042	83278042	83279042			
I		X3A	83270062	83271062	83272062	83274062	83278062	83279062			
I		W7S	83270082	83271082	83272082	83274082	83278082	83279082			
R		W2	83270602	83271602	83272602	83274602	83278602	83279602			
R		W7A5	83270612	83271612	83272612	83274612	83278612	83279612			
C		W2	83270802	83271802	83272802	83274802	83278802	83279802			
C		W7A5	83270812	83271812	83272812	83274812	83278812	83279812			

Function		Connection	
I	Changeover	W2	solder
R	Normally closed	W7A5	for 2.8 mm clips
C	Normally open	W7S	symmetrical for 2.8 x 0.5 mm clips
		X1A	straight for PCB
		X1S	symmetrical straight for PCB
		X2A	rear side for PCB
		X3A	front side for PCB

Microswitches subminiature V4D

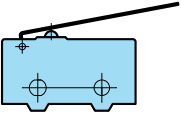
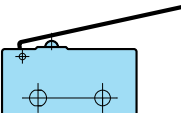
		Rating / Force		10 A / 1.5 N	12 A / 1.5 N	5 A / 1.5 N	5 A / 0.5 N	0.05 A / 1.5 N	0.05 A / 0.5 N
		Type		83270	83271	83272	83274	83278	83279
Actuators	Function	Connection							
 <p>Lever 270A R22.5</p>	I	W2	83270003	83271003	83272003	83274003	83278003	83279003	
	I	W7A5	83270013	83271013	83272013	83274013	83278013	83279013	
	I	X1A	83270023	83271023	83272023	83274023	83278023	83279023	
	I	X1S	83270033	83271033	83272033	83274033	83278033	83279033	
	I	X2A	83270043	83271043	83272043	83274043	83278043	83279043	
	I	X3A	83270063	83271063	83272063	83274063	83278063	83279063	
	I	W7S	83270083	83271083	83272083	83274083	83278083	83279083	
	R	W2	83270603	83271603	83272603	83274603	83278603	83279603	
	R	W7A5	83270613	83271613	83272613	83274613	83278613	83279613	
	C	W2	83270803	83271803	83272803	83274803	83278803	83279803	
	C	W7A5	83270813	83271813	83272813	83274813	83278813	83279813	
	 <p>Lever 270A R41</p>	I	W2	83270004	83271004	83272004	83274004	83278004	83279004
I		W7A5	83270014	83271014	83272014	83274014	83278014	83279014	
I		X1A	83270024	83271024	83272024	83274024	83278024	83279024	
I		X1S	83270034	83271034	83272034	83274034	83278034	83279034	
I		X2A	83270044	83271044	83272044	83274044	83278044	83279044	
I		X3A	83270064	83271064	83272064	83274064	83278064	83279064	
I		W7S	83270084	83271084	83272084	83274084	83278084	83279084	
R		W2	83270604	83271604	83272604	83274604	83278604	83279604	
R		W7A5	83270614	83271614	83272614	83274614	83278614	83279614	
C		W2	83270804	83271804	83272804	83274804	83278804	83279804	
C		W7A5	83270814	83271814	83272814	83274814	83278814	83279814	

Function		Connection	
I	Changeover	W2	solder
R	Normally closed	W7A5	for 2.8 mm clips
C	Normally open	W7S	symmetrical for 2.8 x 0.5 mm clips
		X1A	straight for PCB
		X1S	symmetrical straight for PCB
		X2A	rear side for PCB
		X3A	front side for PCB

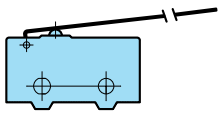
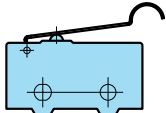

			Rating / Force		10 A / 1.5 N	12 A / 1.5 N	5 A / 1.5 N	5 A / 0.5 N	0.05 A / 1.5 N	0.05 A / 0.5 N	
			Type		83270	83271	83272	83274	83278	83279	
Actuators	Function	Connection									
 <p>Lever 270A R60</p>	I	W2	83270005	83271005	83272005	83274005	83278005	83279005			
	I	W7A5	83270015	83271015	83272015	83274015	83278015	83279015			
	I	X1A	83270025	83271025	83272025	83274025	83278025	83279025			
	I	X1S	83270035	83271035	83272035	83274035	83278035	83279035			
	I	X2A	83270045	83271045	83272045	83274045	83278045	83279045			
	I	X3A	83270065	83271065	83272065	83274065	83278065	83279065			
	I	W7S	83270085	83271085	83272085	83274085	83278085	83279085			
	R	W2	83270605	83271605	83272605	83274605	83278605	83279605			
	R	W7A5	83270615	83271615	83272615	83274615	83278615	83279615			
	C	W2	83270805	83271805	83272805	83274805	83278805	83279805			
	C	W7A5	83270815	83271815	83272815	83274815	83278815	83279815			
	 <p>Lever 270F R18</p>	I	W2	83270006	83271006	83272006	83274006	83278006	83279006		
		I	W7A5	83270016	83271016	83272016	83274016	83278016	83279016		
		I	X1A	83270026	83271026	83272026	83274026	83278026	83279026		
I		X1S	83270036	83271036	83272036	83274036	83278036	83279036			
I		X2A	83270046	83271046	83272046	83274046	83278046	83279046			
I		X3A	83270066	83271066	83272066	83274066	83278066	83279066			
I		W7S	83270086	83271086	83272086	83274086	83278086	83279086			
R		W2	83270606	83271606	83272606	83274606	83278606	83279606			
R		W7A5	83270616	83271616	83272616	83274616	83278616	83279616			
C		W2	83270806	83271806	83272806	83274806	83278806	83279806			
C		W7A5	83270816	83271816	83272816	83274816	83278816	83279816			

Function		Connection	
I	Changeover	W2	solder
R	Normally closed	W7A5	for 2.8 mm clips
C	Normally open	W7S	symetrical for 2.8 x 0.5 mm clips
		X1A	straight for PCB
		X1S	symetrical straight for PCB
		X2A	rear side for PCB
		X3A	front side for PCB

Microswitches subminiature V4D

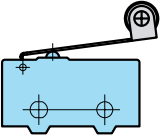
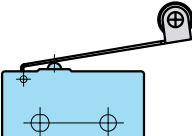
			Rating / Force		10 A / 1.5 N	12 A / 1.5 N	5 A / 1.5 N	5 A / 0.5 N	0.05 A / 1.5 N	0.05 A / 0.5 N
			Type		83270	83271	83272	83274	83278	83279
Actuators	Function	Connection								
 <p>Lever 270E R18.5</p>	I	W2	83270007	83271007	83272007	83274007	83278007	83279007		
	I	W7A5	83270017	83271017	83272017	83274017	83278017	83279017		
	I	X1A	83270027	83271027	83272027	83274027	83278027	83279027		
	I	X1S	83270037	83271037	83272037	83274037	83278037	83279037		
	I	X2A	83270047	83271047	83272047	83274047	83278047	83279047		
	I	X3A	83270067	83271067	83272067	83274067	83278067	83279067		
	I	W7S	83270087	83271087	83272087	83274087	83278087	83279087		
	R	W2	83270607	83271607	83272607	83274607	83278607	83279607		
	R	W7A5	83270617	83271617	83272617	83274617	83278617	83279617		
	C	W2	83270807	83271807	83272807	83274807	83278807	83279807		
	C	W7A5	83270817	83271817	83272817	83274817	83278817	83279817		
	 <p>Lever 270E R24.1</p>	I	W2	83270008	83271008	83272008	83274008	83278008	83279008	
I		W7A5	83270018	83271018	83272018	83274018	83278018	83279018		
I		X1A	83270028	83271028	83272028	83274028	83278028	83279028		
I		X1S	83270038	83271038	83272038	83274038	83278038	83279038		
I		X2A	83270048	83271048	83272048	83274048	83278048	83279048		
I		X3A	83270068	83271068	83272068	83274068	83278068	83279068		
I		W7S	83270088	83271088	83272088	83274088	83278088	83279088		
R		W2	83270608	83271608	83272608	83274608	83278608	83279608		
R		W7A5	83270618	83271618	83272618	83274618	83278618	83279618		
C		W2	83270808	83271808	83272808	83274808	83278808	83279808		
C		W7A5	83270818	83271818	83272818	83274818	83278818	83279818		

Function		Connection	
I	Changeover	W2	solder
R	Normally closed	W7A5	for 2.8 mm clips
C	Normally open	W7S	symetrical for 2.8 x 0.5 mm clips
		X1A	straight for PCB
		X1S	symetrical straight for PCB
		X2A	rear side for PCB
		X3A	front side for PCB

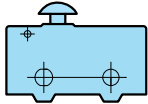

		Rating / Force		10 A / 1.5 N	12 A / 1.5 N	5 A / 1.5 N	5 A / 0.5 N	0.05 A / 1.5 N	0.05 A / 0.5 N
		Type		83270	83271	83272	83274	83278	83279
Actuators	Function	Connection							
 <p>Mushroom head button</p>	I	W2		83270009	83271009	83272009	83274009	83278009	83279009
	I	W7A5		83270019	83271019	83272019	83274019	83278019	83279019
	I	X1A		83270029	83271029	83272029	83274029	83278029	83279029
	I	X1S		83270039	83271039	83272039	83274039	83278039	83279039
	I	X2A		83270049	83271049	83272049	83274049	83278049	83279049
	I	X3A		83270069	83271069	83272069	83274069	83278069	83279069
	I	W7S		83270089	83271089	83272089	83274089	83278089	83279089
	R	W2		83270609	83271609	83272609	83274609	83278609	83279609
	R	W7A5		83270619	83271619	83272619	83274619	83278619	83279619
	C	W2		83270809	83271809	83272809	83274809	83278809	83279809
	C	W7A5		83270819	83271819	83272819	83274819	83278819	83279819

Function		Connection	
I	Changeover	W2	solder
R	Normally closed	W7A5	for 2.8 mm clips
C	Normally open	W7S	symmetrical for 2.8 x 0.5 mm clips
		X1A	straight for PCB
		X1S	symmetrical straight for PCB
		X2A	rear side for PCB
		X3A	front side for PCB



AMERICA

BRAZIL

Custom Sensors & Technologies
Crouzet Latinoamerica
 Alameda Rio Negro
 1084 - cj.A31
 CEP 06454-000 - Alphaville - SP BRASIL
 Tel. : +55 (11) 4191 9797
 Fax : +55 (11) 4191 9136
 E-mail : info@cst-latinoamerica.com
 www.crouzet.com.br
 www.cst-latinoamerica.com

USA/CANADA/MEXICO

Custom Sensors & Technologies - Crouzet
 7230 Hollister Avenue
 Goleta, CA, 93117
 USA
 Tel. : +1 (800) 677 5311
 Fax : +1 (800) 677 3865
 E-mail : customer.service@us.crouzet.com
 www.crouzet.com

OTHER COUNTRIES

Custom Sensors & Technologies
Crouzet Latinoamerica
 Alameda Rio Negro
 1084 - cj.A31
 CEP 06454-000 - Alphaville - SP BRASIL
 Tel. : +55 (11) 4191 9797
 Fax : +55 (11) 4191 9136
 E-mail : info@cst-latinoamerica.com
 www.crouzet.com.br
 www.cst-latinoamerica.com

EUROPE MIDDLE EAST AFRICA

AUSTRIA

Crouzet GmbH
 Zweigniederlassung Österreich
 Spengergasse 1/3
 1050 Wien
 ÖSTERREICH
 Tel. : +43 (0) 1 36 85 471
 Fax : +43 (0) 1 36 85 472
 E-mail : info-direkt@crouzet.com
 www.crouzet.at

BELGIUM

Crouzet NV/SA
 Dieweg 3 B
 B - 1180 Uccle
 BELGIUM
 Tel. : +32 (0) 2 462 07 30
 Fax : +32 (0) 2 461 00 23
 E-mail : com-be@crouzet.com
 www.crouzet.be

FRANCE

Crouzet Automatismes SAS
 2 rue du Docteur Abel - BP 59
 26902 Valence CEDEX 9
 FRANCE
 Tel. : +33 (0) 4 75 44 88 44
 Fax : +33 (0) 4 75 55 98 03
 E-mail : com-fr@crouzet.com
 www.crouzet.fr

Customer service

Indigo 0 825 333 351

Azur FAX 0 810 610 102

GERMANY

Crouzet GmbH
 Otto-Hahn-Str. 3, 40721 Hilden
 Postfach 203, 40702 Hilden
 DEUTSCHLAND
 Tel. : +49 (0) 21 03 9 80-171
 Fax : +49 (0) 21 03 9 80-222
 E-mail : info-direkt@crouzet.com
 www.crouzet.de

ITALY

Crouzet Componenti s.r.l.
 Via Viganò De Vizzi, 93/95
 20092 Cinisello Balsamo (MI)
 ITALIA
 Tel. : +39 (02) 66 599 250
 Fax : +39 (02) 66 599 258
 E-mail : crz-it-sensori-micro@crouzet.com
 www.crouzet.it

SPAIN/PORTUGAL

Crouzet Ibérica
 C/ Aragón 224, 2º 2ª
 08011 Barcelona
 ESPAÑA
 Tel. : +34 (93) 484 39 70
 Fax : +34 (93) 484 39 73
 E-mail : es-consultas@crouzet.es
 www.crouzet.es

THE NETHERLANDS

Crouzet BV
 Industrieweg 17
 2382 NR Zoeterwoude
 NEDERLAND
 Tel. : +31 (0) 71-581 20 30
 Fax : +31 (0) 71-541 35 74
 E-mail : com-nl@crouzet.com
 www.crouzet.nl

UNITED KINGDOM

Crouzet Ltd
 8 Cedarwood
 Chineham Business Park
 Crockford Lane
 Basingstoke, Hampshire
 RG24 8WD
 UNITED KINGDOM
 Tel. : +44 (0)1256 318 900
 Fax : +44 (0)1256 318 901
 E-mail : info@crouzet.co.uk
 www.crouzet.co.uk

SWITZERLAND

Crouzet AG
 Gewerbepark - Postfach 56
 5506 Mägenwil
 SCHWEIZ
 Tel. : +41(0) 62 887 30 30
 Fax : +41(0) 62 887 30 40
 E-mail : info-direkt@crouzet.com
 www.crouzet.ch

OTHER COUNTRIES

Crouzet Automatismes SAS
 2 rue du Docteur Abel - BP 59
 26902 Valence CEDEX 9
 FRANCE
 Tel. : +33 (0) 475 802 102
 Fax : +33 (0) 475 448 126
 E-mail : com-ex@crouzet.com
 www.crouzet.com

ASIA PACIFIC

CHINA & HONG KONG

Custom Sensors & Technologies Asia (Shanghai) Limited - Crouzet
 2 Floor, Innovation Building
 No. 1009, Yi Shan Road
 Shanghai 200233
 CHINA
 Tel. : +86 (21) 2401 7766
 Fax : +86 (21) 6249 0701
 E-mail : china@cstsensors.com
 www.crouzet.cn
 www.cstsensors.com

INDIA

Custom Sensors & Technologies - Crouzet
 Prestige Meridian II
 No. 30, 13th Floor,
 Unit No: 1301 & 1302
 Mahatma Gandhi Road
 Bangalore 560 001
 INDIA
 Tel. : +91 (0) 80 4113 2204/05
 Fax : +91 (0) 80 4113 2206
 E-mail : crz_bangalore@crouzet.com
 www.crouzet.co.in
 www.cstsensors.com

TAIWAN

Custom Sensors & Technologies - Crouzet
 3F, No. 39, Ji-Hu Road
 Nei-Hu Dist. - Taipei 114
 TAIWAN
 Tel. : +886 (0)2 8751 6388
 Fax : +886 (0)2 2657 8725
 E-mail : taiwan@cstsensors.com
 www.crouzet.tw
 www.cstsensors.com

KOREA & JAPAN

Custom Sensors & Technologies - Crouzet
 5F, Jeil Bldg,
 94-46 Youngdeungpo-dong
 7-ga Youngdeungpo-gu
 Seoul 150-037
 SOUTH KOREA
 Tel. : +82 (0)2 2629 8312
 Fax : +82 (0)2 2629 8310
 E-mail : korea@cstsensors.com
 www.crouzet.tw
 www.cstsensors.com

SOUTH EAST ASIA & PACIFIC

Custom Sensors & Technologies - Crouzet
 3F, No. 39, Ji-Hu Road
 Nei-Hu Dist. - Taipei 114
 TAIWAN
 Tel. : +886 (0)2 8751 6388
 Fax : +886 (0)2 2657 8725
 E-mail : eap@cstsensors.com
 www.crouzet.tw
 www.cstsensors.com

Warning:

The product information contained in this catalogue is given purely as information and does not constitute a representation, warranty or any form of contractual commitment. CROUZET Automatismes and its subsidiaries reserve the right to modify their products without notice. It is imperative that we should be consulted over any particular use or application of our products and it is the responsibility of the buyer to establish, particularly through all the appropriate tests, that the product is suitable for the use or application. Under no circumstances will our warranty apply, nor shall we be held responsible for any application (such as any modification, addition, deletion, use in conjunction with other electrical or electronic components, circuits or assemblies, or any other unsuitable material or substance) which has not been expressly agreed by us prior to the sale of our products.

Headquartered in Moorpark, California-USA, **Custom Sensors & Technologies (CST)** is made up of the leading brands of Crouzet, Kavlico and Crydom, as well as the former divisions of BEI Technologies, including Newall and Systron Donner. CST provides sensors, controls, and actuation products to the transportation, industrial, and aerospace & defense markets.

www.cstsensors.com

Distributed by:

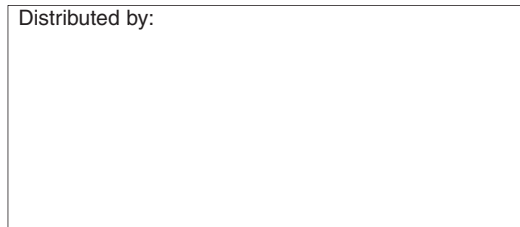

Crouzet Automatismes SAS

2 rue du Docteur Abel - BP 59
 26902 Valence CEDEX 9
 FRANCE

www.crouzet.com

CRZ BR 43/A EN
 Ref. 67231009 EN
 11/2009

Creation-Design: 3C Evolution, Crouzet Automatismes
 Editing-Publishing: 3C Evolution
 Photos-Graphics: Ginko, Daniel Lattard, Schneider Electric
 Printing: