

PAN9420

Fully Embedded Stand-Alone Wi-Fi Module

Product Specification

Rev. 1.2



Overview

The PAN9420 is a 2.4 GHz ISM band Wi-Fi-embedded module which includes a wireless radio and an MCU for easy integration of Wi-Fi connectivity into various electronic devices.

Features

- Fully embedded: integrated full-featured network stack
- Contains all necessary IoT functionality (Place & Play)
- Integrated webserver with AJAX/JSON for web applications
- No stack or software implementation needed on a host MCU
- Simultaneous support of Access-Point- & Infrastructure mode
- Fully automatical IP configuration
- DHCP server offers IP configuration in AP mode
- Access by names (<http://yourdevice>)
- Integrated TCP/IP network stack: IPv4, ARP, and AutoIP
- Supports TLS/SSL, https, and Wi-Fi security (WPA2) for secure data connection
- Over-the-Air firmware update
- Two UART interfaces (command and transparent data)
- Integrated QSPI flash memory for customer web contents and configuration file

- Programming via standard JTAG
- Evaluation kit with pre-installed web application for quick prototyping available
- Evaluation and development tool WiFigurator for Windows
- Getting started tutorials, PC tool, quickstart guide
- Wide temperature range of -40 °C to +85 °C

Characteristics

- Surface Mount Type (SMT)
29.0 mm x 13.5 mm x 2.66 mm
- Marvell® 88MW300 MCU/WLAN System-on-Chip (SoC) inside
- Tx power up to +16 dBm @ IEEE 802.11b
- Rx sensitivity of -97 dBm @ IEEE 802.11b DSSS 1 Mbps
- 20 MHz channels up to 72 Mbps
- Power supply 3.0 to 3.6 V
- Current consumption 150 mA (mix mode Tx/Rx @ 11b, 11 Mbps), 75 mA Rx, 310 mA Tx peak
- Power down mode < 1 mA power consumption
- Low power mode available

Delta PAN9420 vs PAN9320

- PAN9320 replaceable by PAN9420 without changes on mother PCB
- Reduced power consumption in transmit, idle, and power down
- Enhanced temperature range of -40 °C to +85 °C

Block Diagram

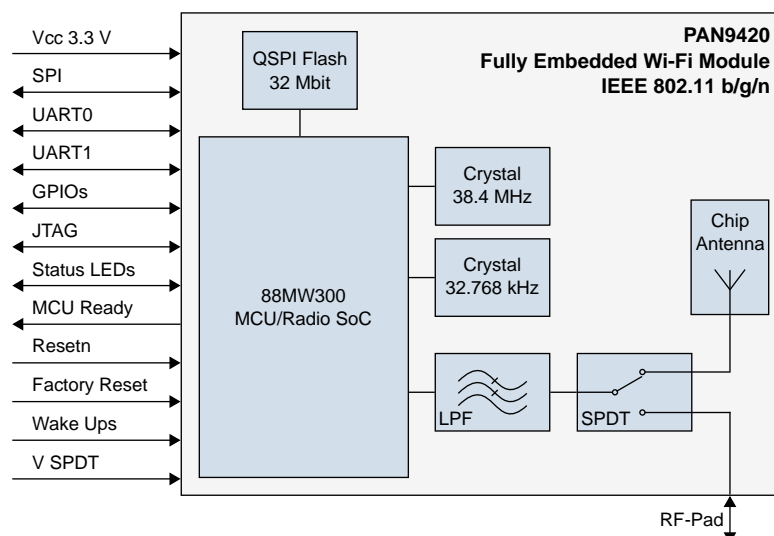

By purchase of any of the products described in this document the customer accepts the document's validity and declares their agreement and understanding of its contents and recommendations. Panasonic reserves the right to make changes as required at any time without notification. Please consult the most recently issued Product Specification before initiating or completing a design.

© Panasonic Industrial Devices Europe GmbH 2017.

This specification sheet is copyrighted. Reproduction of this document is permissible only if reproduction is without alteration and is accompanied by all associated warranties, conditions, limitations, and notices. Do not disclose it to a third party.

All rights reserved.

This Product Specification does not lodge the claim to be complete and free of mistakes.

Engineering Samples (ES)

If Engineering Samples are delivered to the customer, these samples have the status "Engineering Samples". This means that the design of this product is not yet concluded. Engineering Samples may be partially or fully functional, and they may differ from the published Product Specification.

Engineering Samples are not qualified and they are not to be used for reliability testing or series production.

Disclaimer

The customer acknowledges that samples may deviate from the Product Specification and may bear defects due to their status of development and the lack of qualification mentioned above.

Panasonic rejects any liability or product warranty for Engineering Samples. In particular, Panasonic disclaims liability for damages caused by:

The use of the Engineering Sample other than for evaluation purposes, particularly the installation or integration in another product to be sold by the customer,

Deviation or lapse in function of the Engineering Sample,

Improper use of the Engineering Sample.

Panasonic Industrial Devices Europe GmbH disclaims any liability for consequential and incidental damages. In case of any queries regarding the Engineering Samples, please contact your local sales partner or the related product manager.

Table of Contents

1	About This Document	5
1.1	Purpose and Audience	5
1.2	Revision History.....	5
1.3	Use of Symbols	5
1.4	Related Documents	5
2	Overview	6
2.1	Block Diagram	7
2.2	Pin Configuration	8
2.3	Host Interfaces	11
2.4	Peripheral Bus Interface	11
2.5	WLAN Features	12
3	Detailed Description	14
3.1	Dimensions.....	14
3.2	Footprint	15
3.3	Packaging.....	16
3.4	Case Marking	19
4	Specification	20
4.1	Default Test Conditions	20
4.2	Absolute Maximum Ratings.....	20
4.3	Recommended Operating Conditions.....	21
4.4	RF Electrical Characteristics.....	29
4.5	Reliability Tests	33
4.6	Recommended Soldering Profile	34
5	Cautions	35
5.1	Design Notes	35
5.2	Installation Notes	35
5.3	Usage Condition Notes.....	36
5.4	Storage Notes.....	36
5.5	Safety Cautions	36
5.6	Other Cautions	37
5.7	Life Support Policy.....	37
6	Regulatory and Certification Information	38
6.1	Federal Communications Commission (FCC) for US	38
6.2	Innovation, Science, and Economic Development (ISED) for Canada	40
6.3	European Conformity According to RED (2014/53/EU)	43
6.4	RoHS and REACH Declaration	43
7	Appendix	44
7.1	Ordering Information.....	44
7.2	Contact Details	45

1 About This Document



1.1 Purpose and Audience

This Product Specification provides details on the functional, operational, and electrical characteristics of the Panasonic PAN9420 module. It is intended for hardware design, application, and Original Equipment Manufacturers (OEM) engineers. The product is referred to as “the PAN9420” or “the module” within this document.

1.2 Revision History

Revision	Date	Modifications/Remarks
0.1	01.02.2017	1st preliminary version
0.2	31.05.2017	Improved layout
1.0	02.06.2017	Technical data corrected
1.1	19.06.2017	FCC/IC/RED information added
1.2	29.09.2017	Add technical data

1.3 Use of Symbols

Symbol	Description
	Note Indicates important information for the proper use of the product. Non-observance can lead to errors.
	Attention Indicates important notes that, if not observed, can put the product's functionality at risk.
⇒ [chapter number] [chapter title]	Cross reference Indicates cross references within the document. Example: Description of the symbols used in this document ⇒ 1.3 Use of Symbols .

1.4 Related Documents

Please refer to the Panasonic website for related documents ⇒ [7.2.2 Product Information](#).

2 Overview

The PAN9420 is a 2.4 GHz 802.11 b/g/n embedded Wi-Fi module with integrated stack and API that minimizes firmware development and includes a full security suite. The module is specifically designed for highly integrated and cost-effective applications. The module includes a fully shielded case, integrated crystal oscillators, and a chip antenna.

The module combines a high-performance CPU, high-sensitivity wireless radio, baseband processor, medium access controller, encryption unit, boot ROM with patching capability, internal SRAM, and in-system programmable flash memory. The module's integrated memory is available to the application for storing web content such as HTML pages or image data.

Parallel support of access point and infrastructure mode allows easy setup of simultaneous Wi-Fi connections from the module to smart devices and home network routers.

The pre-programmed Wi-Fi SoC firmware enables client (STA), micro access point (uAP), and Ad-hoc mode (Wi-Fi Direct) applications. With the transparent mode, raw data can be sent from the UART to the air interface to smart devices, web servers, or PC applications.



The PAN9420 supports Over-the-Air firmware updates. In order to make use of this feature, the customer needs to ensure that the appropriate preconditions are fulfilled and that a suitable environment is provided, particularly with regard to:

- Module configuration
- Utilization of the related module interface commands
- Server infrastructure and application

Please refer to the Panasonic website for related documents ⇒ [7.2.2 Product Information](#).

Further information on the variants and versions ⇒ [7.1 Ordering Information](#).

2.1 Block Diagram

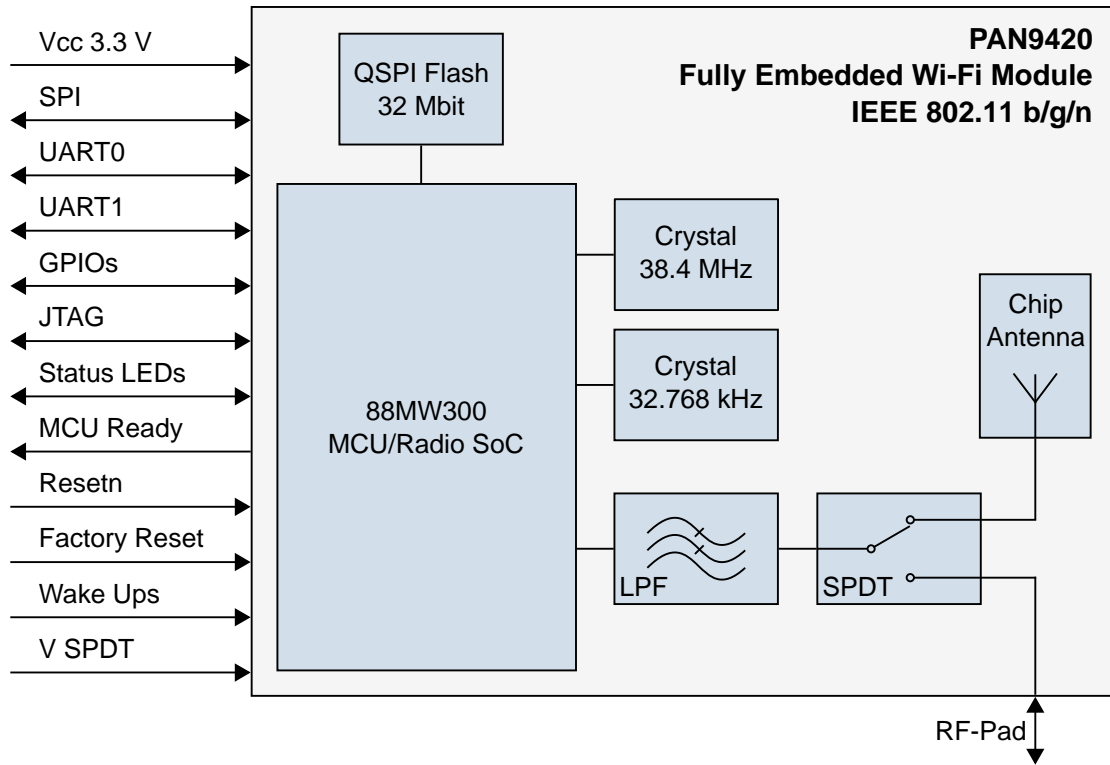

2.2 Pin Configuration

Pin Assignment

Top View

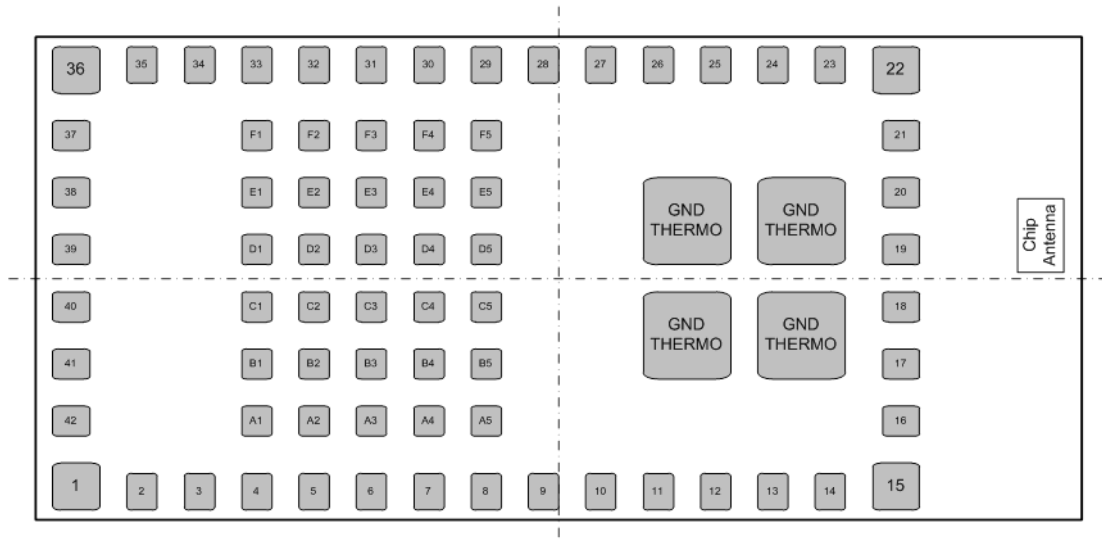

Pin Functions

No	Pin Name	Pin Type	Description
1	GND	Ground Pin	Connect to ground
2	GPIO4 ¹	Digital I/O	Digital I/O #4
3	GPIO5 ¹	Digital I/O	Digital I/O #5
4	NC	NC	Do not connect
5	NC	NC	Do not connect
6	NC	NC	Do not connect
7	3.3 V	Power	3.0 V-3.6 V power supply connection (typical 3.3 V)
8	3.3 V	Power	3.0 V-3.6 V power supply connection (typical 3.3 V)
9	UART1 CTS	Digital In	CTS _n for UART1 (using hardware flow control)
10	UART1 RTS	Digital Out	RTS _n for UART1 (using hardware flow control)
11	UART1 TXD	Digital Out	TXD for UART1
12	UART1 RXD	Digital In	RXD for UART1
13	NC	NC	Do not connect
14	GND	Ground Pin	Connect to ground
15	GND	Ground Pin	Connect to ground

¹ All GPIOs are initially set to output with low level

No	Pin Name	Pin Type	Description
16	NC/RF	NC/Analog IO	RF in/out over 50Ω bottom pad
17	GND	Ground Pin	Connect to ground
18	GND	Ground Pin	Connect to ground
19	GND	Ground Pin	Connect to ground
20	GND	Ground Pin	Connect to ground
21	GND	Ground Pin	Connect to ground
22	GND	Ground Pin	Connect to ground
23	GND	Ground Pin	Connect to ground
24	GND	Ground Pin	Connect to ground
25	GND	Ground Pin	Connect to ground
26	W STAT LED	Digital Out	Connect to LED wireless (Wi-Fi) status, active low
27	UART0 TXD/DUAL STAT	Digital Out	TXD for UART0/UART1 state (binary data or command)
28	UART0 RXD/DUAL SW	Digital In	RXD for UART0/UART1 toggle switch for the control of the state
29	GPIO49 ¹	Digital I/O	Digital I/O #49
30	GPIO48 ¹	Digital I/O	Digital I/O #48
31	GPIO47 ¹	Digital I/O	Digital I/O #47
32	GPIO46 ¹	Digital I/O	Digital I/O #46
33	STAT LED1	Digital Out	Connect to LED MCU status (heartbeat), active low
34	STAT LED2	Digital Out	Connect to LED IP connectivity (allocated IP), active low
35	STAT LED3	Digital Out	Connect to LED Error (active during booting), active low
36	GND	Ground Pin	Connect to ground
37	RESETn	Digital In	Reset MCU, active low
38	WAKE UP0 ²	Digital In	Wake up signal for MCU/WLAN SoC, active high
39	NC	NC	Do not connect
40	NC	NC	Do not connect
41	MCU READY	Digital Out	Connect to LED MCU ready (booting ready), active high
42	FACTORY RESET	Digital In	Factory reset (valid after 10 seconds), active high
A1	NC	NC	Do not connect
A2	NC	NC	Do not connect
A3	NC	NC	Do not connect
A4	SPDT V1	Input Signal	Do not connect if on-board antenna In/Out is desired, for RF-Pad In/Out ⇒ 4.3.2 Module Selectable RF-In/Output .

² Connect to HOST MCU (wake up after shut-off mode, active high), use 10 kOhm resistor to GND at pin

No	Pin Name	Pin Type	Description
A5	SPDT V2	Input Signal	Do not connect if on-board antenna In/Out is desired, for RF-Pad In/Out ⇒ 4.3.2 Module Selectable RF-In/Output.
B1	NC	NC	Do not connect
B2	NC	NC	Do not connect
B3	NC	NC	Do not connect
B4	NC	NC	Do not connect
B5	NC	NC	Do not connect
C1	NC	NC	Do not connect
C2	NC	NC	Do not connect
C3	WAKE UP1 ²	Digital In	Wake up signal for MCU/WLAN SoC, active high
C4	NC	NC	Do not connect
C5	NC	NC	Do not connect
D1	TDI	Digital In	TDI for JTAG (option for flashing in production process)
D2	TRSTn	Digital In	TRSTn for JTAG (option for flashing in production process)
D3	NC	NC	Do not connect
D4	NC	NC	Do not connect
D5	NC	NC	Do not connect
E1	TDO	Digital Out	TDO for JTAG (option for flashing in production process)
E2	TCK	Digital Out	TCK for JTAG (option for flashing in production process)
E3	TMS	Digital I/O	TMS for JTAG (option for flashing in production process)
E4	NC	NC	Do not connect
E5	NC	NC	Do not connect
F1	NC	NC	Do not connect
F2	NC	NC	Do not connect
F3	GND	Ground Pin	Connect to ground
F4	GND	Ground Pin	Connect to ground
F5	GND	Ground Pin	Connect to ground
GND THERMO		Thermal Pin	Connect to ground
GND THERMO		Thermal Pin	Connect to ground
GND THERMO		Thermal Pin	Connect to ground
GND THERMO		Thermal Pin	Connect to ground

2.3 Host Interfaces

UART0 Interface

- 2-wire data transfer (RX, TX)
- Programmable baud rate (300 bps to 1.5 Mbps)
- Data format (LSB first)
- Data bit: (5-8 bit)
- Parity bit: (0-3 bit)
- Stop bit: (1-2 bit)

UART1 Interface

- 4-wire data transfer (RX, TX, RTS, CTS)
- Programmable baud rate (300 bps to 1.5 Mbps)
- Data format (LSB first)
- Data bit: (5-8 bit)
- Parity bit: (0-3 bit)
- Stop bit: (1-2 bit)

Further information ⇒ [4.3.7 Host Interface Specification](#).

2.4 Peripheral Bus Interface

Embedded MCU and WLAN Radio (SoC)

Features	Characteristics
JTAG	<ul style="list-style-type: none"> • Standard JTAG interface
General Purpose I/O (GPIO) Interface	<ul style="list-style-type: none"> • Defined GPIOs, I/O configured to either input or output (on/off) • GPIOs with LED status functionality (ready, heartbeat, IP-connectivity, error and WLAN connectivity)
Wake Up 0 / 1	<ul style="list-style-type: none"> • External signal for wake-up after shut-off mode

Further information ⇒ [4.3.8 Peripheral Interface Specification](#).

2.5 WLAN Features

Type	Features
IEEE 802.11/Standards	<ul style="list-style-type: none"> • 802.11 data rates 1 and 2 Mbps (DSSS) • 802.11b data rates 5.5 and 11 Mbps (CCK) • 802.11g data rates 6, 9, 12, 18, 24, 36, 48, and 54 Mbps (OFDM) • 802.11b/g performance enhancements • 802.11n-compliant with maximum data rates up to 72 Mbps (20 MHz channel) • 802.11d international roaming³ • 802.11i enhanced security • 802.11k radio resource measurement³ • 802.11r fast hand-off for AP roaming³ • 802.11w protected management frames³ • Support clients (stations) implementing IEEE Power Save mode • Wi-Fi direct connectivity³
WLAN MAC	<ul style="list-style-type: none"> • Simultaneous peer-to-peer and Infrastructure Modes • RTS/CTS for operation and DCF • Hardware filtering of 32 multicast addresses • On-chip Tx and Rx FIFO for maximum throughput • Open System and Shared Key Authentication services • A-MPDU RX (de-aggregation) and TX (aggregation) • Reduced Inter-Frame Spacing (RIFS) bursting • Management information base counters • Radio resource measurement counters • Quality of service queues • Block acknowledgement extensions • Multiple-BSSID and Multiple-Station operation • Transmit rate adaptation • Transmit power control • Long and short preamble generation on a frame-by-frame basis for 802.11b frames • Marvell® Mobile Hotspot

³ Hardware-supported, not implemented in the pre-installed firmware stack

Type	Features
WLAN Baseband	<ul style="list-style-type: none"> • 802.11n 1x1 SISO (WLAN SoC with SISO RF radio) • Backward compatibility with legacy 802.11b/g technology • PHY data rates up to 72.2 Mbps • 20 MHz bandwidth/channel • Modulation and Coding Scheme MCS 0 ~ 7 • Radio resource measurement • Optional 802.11n SISO features: <ul style="list-style-type: none"> – 1 spatial stream (STBC) reception and transmission – Short guard interval – RIFS on receive path for 802.11n packets – 802.11n greenfield Tx/Rx
WLAN Radio	<ul style="list-style-type: none"> • Integrated direct-conversion radio • 20 MHz channel bandwidth • Embedded WLAN Radio SoC with the following features: <ul style="list-style-type: none"> – Direct conversion radio (no need for external SAW filter) – 2.4 GHz TX/RX switch, Power Amplifier (PA) and Low Noise Amplifier (LNA) path – Gain selectable LNAs with optimized noise figure and power consumption – Power Amplifiers with power control – Optimized TX gain distribution for linearity and noise performance – Fine channel step with AFC (adaptive frequency control)
WLAN Encryption	<ul style="list-style-type: none"> • Embedded WLAN Radio SoC with the following features: <ul style="list-style-type: none"> – WEP 64-bit and 128-bit encryption with hardware TKIP processing (WPA) – AES-CCMP hardware implementation as part of 802.11i security standard (WPA2) – Enhanced AES engine performance – AES-Cipher-Based Message Authentication Code (CMAC) as part of the 802.11w security standard³

3 Detailed Description

3.1 Dimensions

 All dimensions are in millimeters.

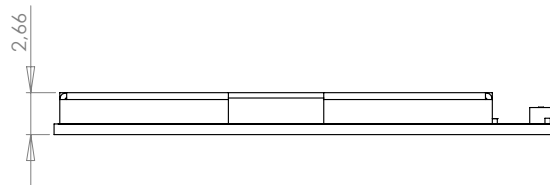
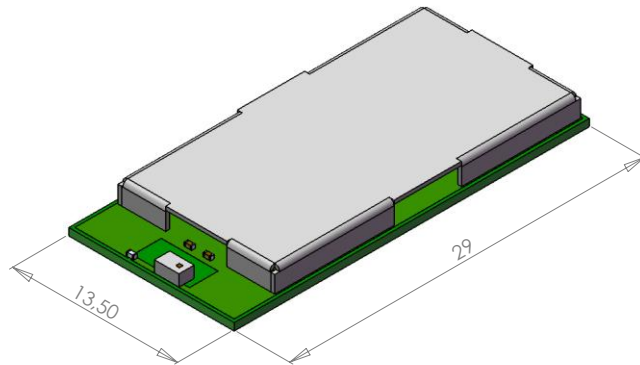

No.	Item	Dimension	Tolerance	Remark
1	Width	13.50	± 0.35	
2	Length	29.00	± 0.35	
3	Height	2.66	± 0.20	with case

3.2 Footprint

 The outer dimensions have a tolerance of ± 0.35 mm.

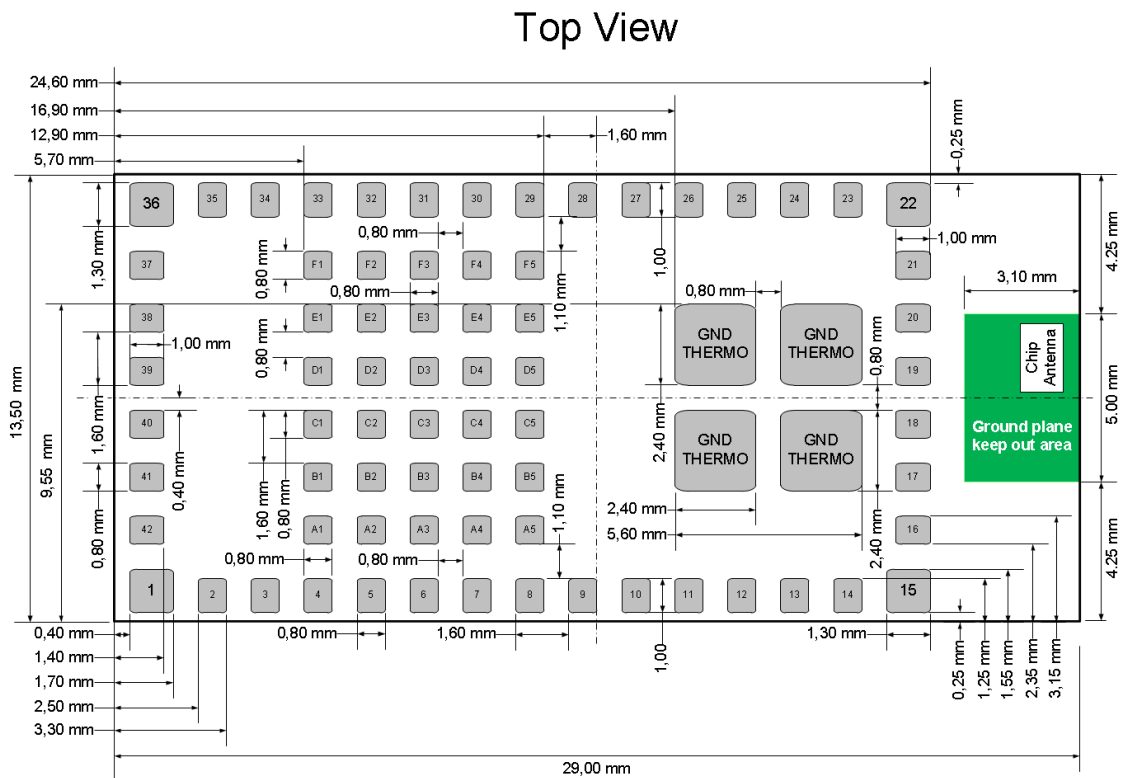

3.3 Packaging

The product is a mass production status product and will be delivered in the package described below.

3.3.1 Tape Dimensions

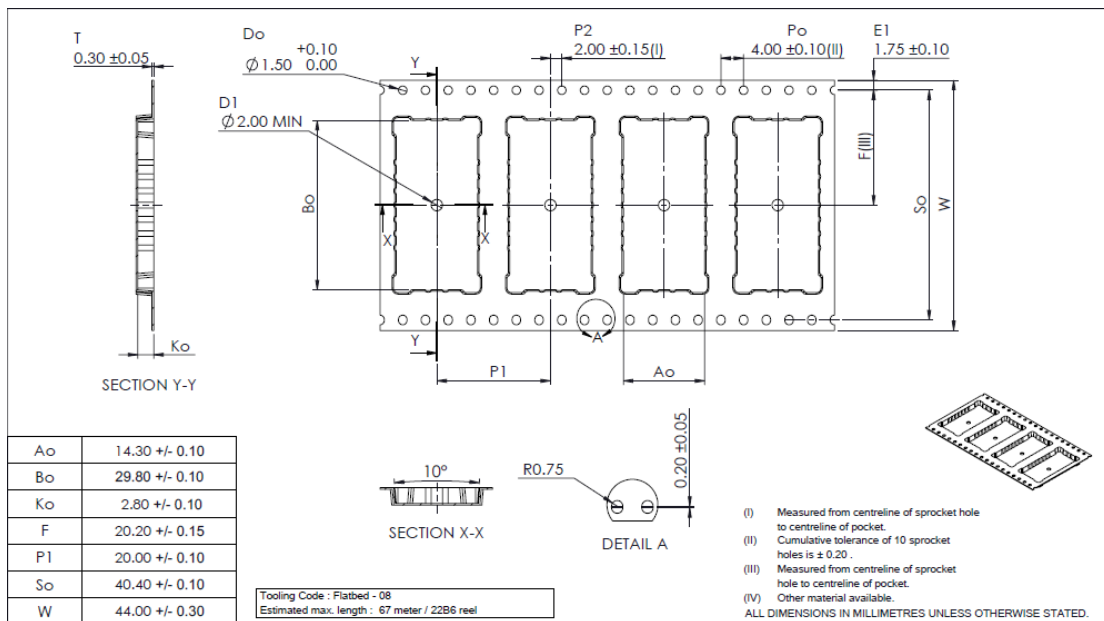

3.3.2 Packing in Tape

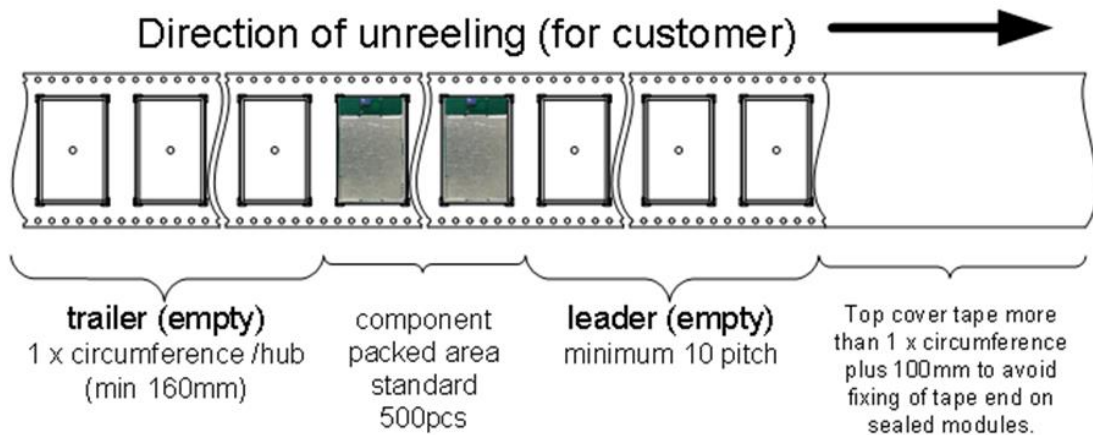

Empty spaces in the component packed area shall be less than two per reel and those spaces shall not be consecutive.

The top cover tape shall not be found on reel holes and it shall not stick out from the reel.

3.3.3 Component Direction

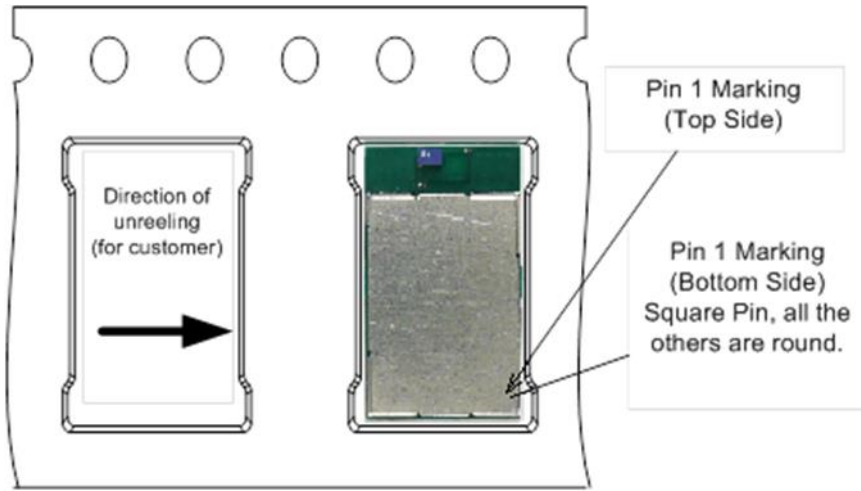

3.3.4 Reel Dimension

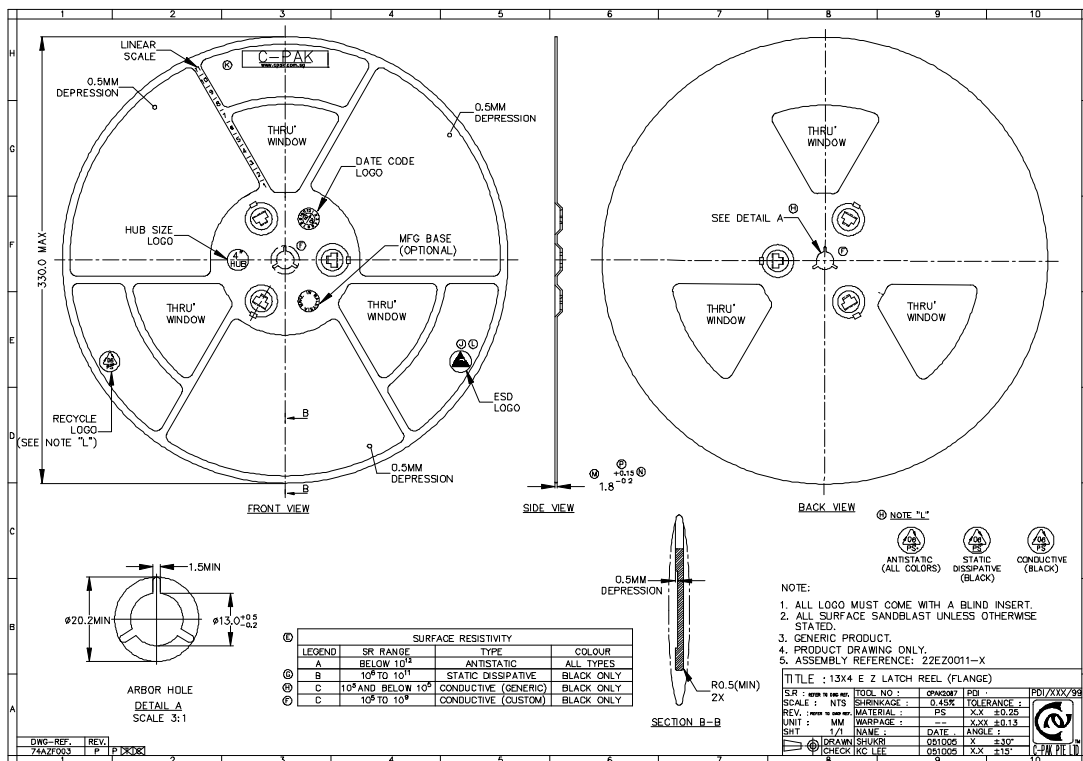

3.3.5 Package Label

Example

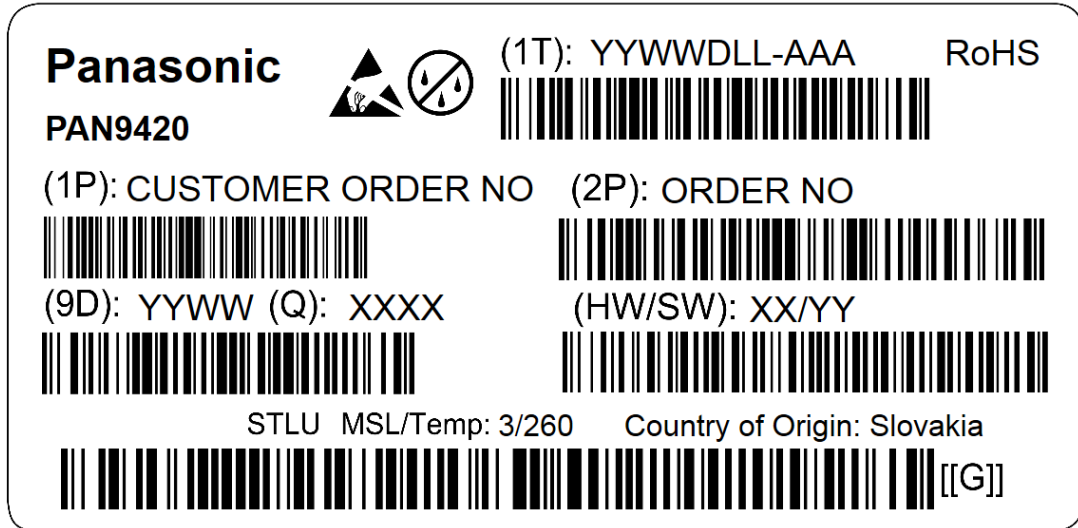

(1T)	Lot code
(1P)	Customer order number, if applicable
(2P)	Order number
(9D)	Date code
(Q)	Quantity
(HW/SW)	Hardware/Software version

3.3.6 Total Package

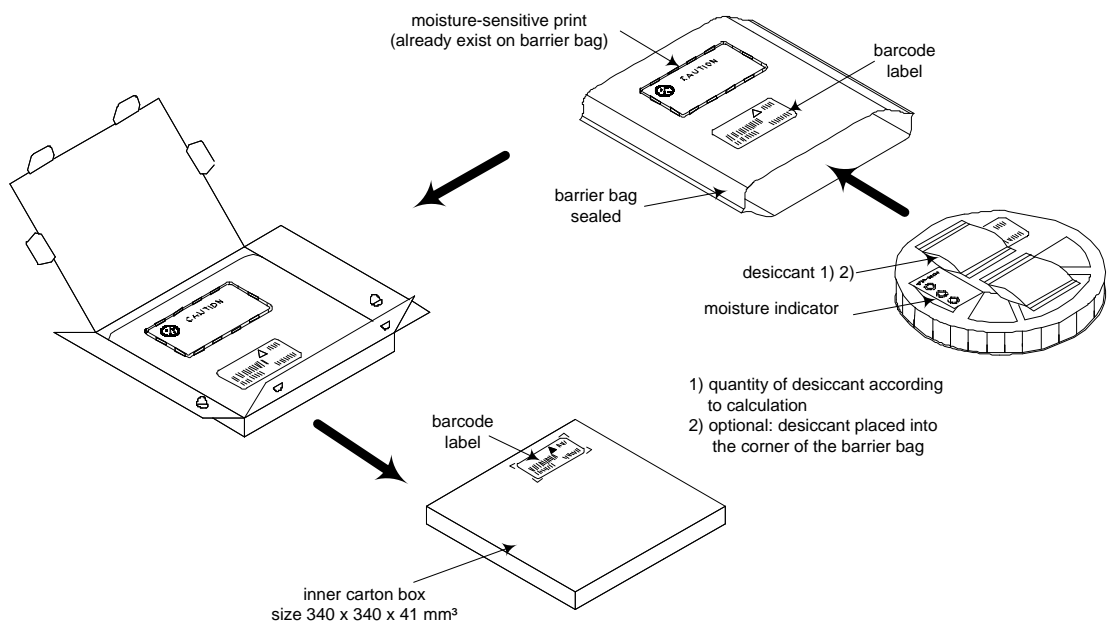

3.4 Case Marking

Example for PAN9420 (FCC version)



1	Brand name
2	Hardware/Software version
3	Engineering Sample (optional)
4	Model Name/ENW number
5	Lot code
6	Serial number
7	WLAN MAC address
8	FCC ID
9	IC Canada
10	Marking for Pin 1
11	2D-barcode, for internal usage only

4 Specification



All specifications are over temperature and process, unless indicated otherwise.

4.1 Default Test Conditions



Temperature: 25 ± 10 °C
 Humidity: 40 to 85 % RH
 Supply Voltage: 3.3 V

4.2 Absolute Maximum Ratings



The maximum ratings may not be exceeded under any circumstances, not even momentarily or individually, as permanent damage to the module may result.

Symbol	Parameter	Condition	Min.	Typ.	Max.	Units
T _{STOR}	Storage temperature		-40		+85	°C
V _{ESD}	ESD robustness	All pads, according to human body model (HBM), JEDEC STD 22, method A114			1 000	V
		According to charged device model (CDM), JEDEC STD 22, method C101			500	V
P _{RF}	RF input level				+20	dBm
V _{DDMAX}	Maximum voltage	Maximum power supply voltage from any pin with respect to V _{SS} (GND)	-0.4		3.6	V
V _{DIG}	Voltage on any digital pins	GPIOs, RESETn, UART, QSPI, Coex I/F	-0.4		V _{DDMAX}	V

4.3 Recommended Operating Conditions



The maximum ratings may not be exceeded under any circumstances, not even momentarily or individually, as permanent damage to the module may result.

Symbol	Parameter	Condition	Min.	Typ.	Max.	Units
T _A	Ambient operating temperature range	Industrial grade	-40		+85	°C
V _{DD}	3V3 Supply voltage ⁴	Voltage on pins 7, 8 (3.3 V) I/O supply voltage internally connected to V _{DD} /V _{CC}	3.0	3.3	3.6	V

4.3.1 Digital Pin Characteristics

Symbol	Parameter	Condition	Min.	Typ.	Max.	Units
V _{IH}	High level input voltage ⁵	3.3 V operation (V _{IO} = V _{DD})	0.7 V _{DD}		V _{DD} +0.3	V
V _{IL}	Low level input voltage ⁵	3.3 V operation (V _{IO} = V _{DD})	-0.4		0.3 V _{DD}	V
I _{OH} @ V _{DD} -0.5 V	High level output current ⁵	3.3 V operation (V _{IO} = V _{DD})		3		mA
I _{OL} @ 0.4 V	Low level output current ⁵	3.3 V operation (V _{IO} = V _{DD})		4		mA

4.3.2 Module Selectable RF-In/Output

Module RF-Output can be switched between on-board ceramic chip antenna and 50 Ohm RF-pad (pin 16) output by adjusting voltage level on pin A4 and A5. If pin A4 and A5 are not connected (NC), output state will be on-board ceramic chip antenna.

RF In/Output	Pin A4	Pin A5
On-board ceramic chip antenna output	NC or 3.0 V – 3.6 V (typ. 3.3V)	NC or GND (0 V)
Module 50 Ohm RF-pad output (pin 16)	GND (0 V)	3.0 V – 3.6 V (typ. 3.3 V)

⁴ The supply current must be limited to max. 1A

⁵ The capacitive load should not be larger than 50 pF for all I/Os when using the default driver strength settings. Large capacitance loads generally increase the overall current consumption.

4.3.3 Current Consumption



The current consumption depends on the user scenario and on the setup and timing in the power modes.

Assume $V_{DD} = 3.3\text{ V}$, $T_{amb} = 25\text{ °C}$, if nothing else stated.

Symbol	Parameter	Condition	Min.	Typ.	Max.	Units
I_{TX}	Active Transmit ⁶	$P_{TX} = +16\text{ dBm}$ for 802.11b		310		
I_{TX-Rx}	Active Transmit ⁷ (Tx / Rx mixed mode)	$P_{TX} = +16\text{ dBm}$ for 802.11b @ 11 Mbps		170		mA
		$P_{TX} = +14\text{ dBm}$ for 802.11g @ 54 Mbps		115		mA
		$P_{TX} = +13\text{ dBm}$ for 802.11n (20 MHz) @ 65Mbps		85		mA
I_{RX}	Active Receive ⁸	802.11b @ 11 Mbps		75		mA
		802.11g @ 54 Mbps		75		mA
		802.11n @ 65 Mbps		75		mA
I_{RXIdle}	Receive Idle ⁹	Passive receive state, ready to receive packets, but no active decoding		75		mA
$I_{Shut-off}$	Shut-off	MCU and Radio in shut-off mode			1	mA

4.3.4 Internal Operating Frequencies

Symbol	Parameter	Condition	Min.	Typ.	Max.	Units
$f_{SYSCLK1}$	CPU/System/ Encryption clock speed				200	MHz
$f_{REFCLK1}$	WLAN/MCU Crystal fundamental frequency	Frequency tolerance $< \pm 10\text{ ppm}$ over operating temperature and process		38.4		MHz
$f_{REFCLK2}$	Sleep Clock Crystal fundamental frequency	Frequency tolerance $< \pm 10\text{ ppm}$ over operating temperature and process		32.768		kHz

⁶ Peak values for specified output power level and data rate with UDP traffic between the AP and Device (STA).

⁷ Average values for specified output power level and data rate with UDP traffic between the AP and Device (STA).

⁸ Average values for specified data rate with UDP traffic between the AP and Device (STA).

⁹ The device is powered on and is ready to receive packets, but it is not actively decoding.

4.3.5 Power Up Sequence



When the power is turned on, set reset signal to low (RESETn = low).

After the V_{DD} is stable, release the reset (RESETn = high).

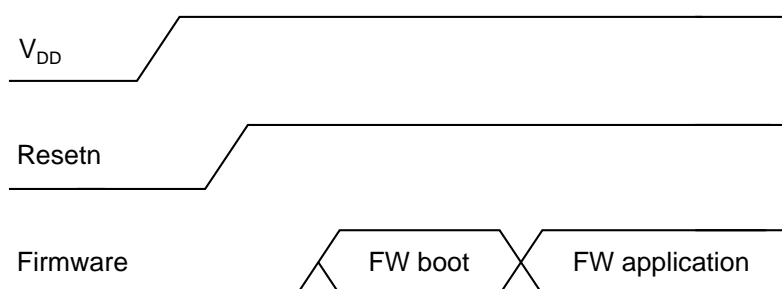

4.3.6 Firmware-Related Timing

Symbol	Parameter	Min.	Typ.	Max.	Units
T _{MCU READY}	Time period from Power up or Reset until MCU READY pin is active		4	5	sec
T _{WAKE UP}	Time period needed to set pin active to wake-up from shut-off mode (afterwards firmware is booting)			100	ms
T _{FACTORY RESET}	Time period needed to set pin active to release factory reset (afterwards firmware is booting)		8	10	sec
T _{INFRA ASSO}	Time period in Infrastructure mode from WLAN association request until association with selected Access-Point's SSID		4		sec
T _{DE-ASSO SCAN}	Time period between de-association from AP until next scan is released		60		sec
T _{IP DHCP}	Time period from IP DHCP request until IP assignment			90	sec

4.3.7 Host Interface Specification

4.3.7.1 UART0 Command Interface

Bus Signals

Module Pin No	Signal Name	Function	Description
27	UART0 TXD	Command	Transmit data output
28	UART0 RXD		Receive data input

Protocol

Item	Range	Default	Comment
Baud rate	300 ~ 1 500 000	115 200	Baud
Data bits	5 ~ 8 (LSB first)	8	LSB first
Parity bits	0 ~ 3	0	Even, odd, or no parity detection
Stop bit	1/2	1	

Supported Baud Rates

Baud								
300	600	1 200	2 400	4 800	9 600	14 400	19 200	28 800
38 400	56 000	57 600	115 200	128 000	256 000	520 000	780 000	1 500 000

UART0 Timing Diagram

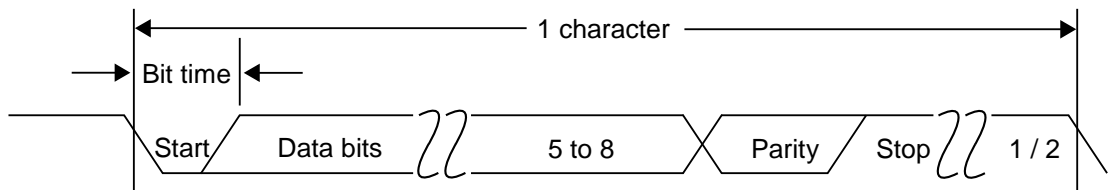

4.3.7.2 UART1 Binary Data Interface

Bus Signals

Module Pin No	Signal Name	Function	Description
9	UART1 CTS	Binary data	Clear to send
10	UART1 RTS		Request to send
11	UART1 TXD		Transmit data output
12	UART1 RXD		Receive data input

Protocol

Item	Range	Default	Comment
Baud rate	300 ~ 1 500 000	115 200	Baud
Data bits	5 ~ 8 (LSB first)	8	LSB first
Parity bits	0 ~ 3	0	Even, odd, or no parity detection
Stop bit	1/2	1	

Supported Baud Rates

Baud								
300	600	1 200	2 400	4 800	9 600	14 400	19 200	28 800
38 400	56 000	57 600	115 200	128 000	256 000	520 000	780 000	1 500 000

UART1 Timing Diagram

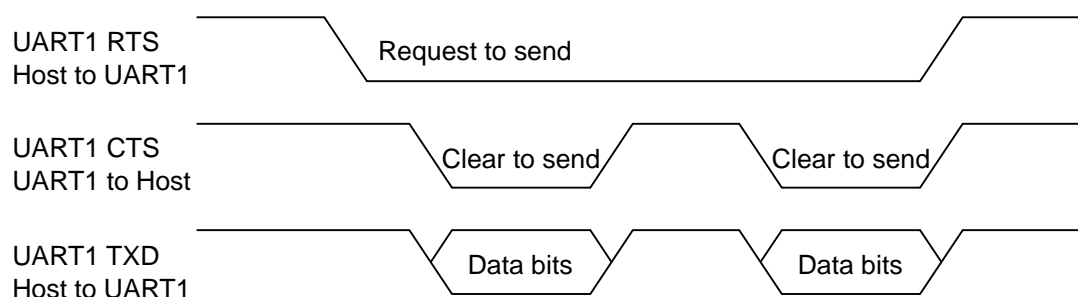

4.3.7.3 UART1 Dual Interface

Bus Signals

Module Pin No	Signal Name	GPIO Definition	GPIO Level Default	State Default	Description
9	UART1 CTS	OUT	-	-	Clear to send
10	UART1 RTS	IN			Request to send
11	UART1 TXD	IN			Transmit data output
12	UART1 RXD	OUT			Receive data input
27	DUAL STAT	OUT	HIGH	Binary data	UART1 state condition (binary or command)
28	DUAL SW	IN			UART1 toggle switch for binary/command

Specification of protocol and supported baud rates ⇒ [4.3.7.2 UART1 Binary Data Interface](#).

The usage of the UART1 dual interface needs to be configured in the Customer Config of the firmware. After booting, the MCU READY pin changes from low level to high level. As start condition, the DUAL SW input pin needs to be pre-set from the HOST by changing from high level to low level. The DUAL STAT output pin signals high level as Binary state. In this case, the HOST is able to transmit or receive binary data.

To change from Binary to Command state, the DUAL SW input pin needs to be toggled (low - high - low level change) from the HOST:

1. The change of state is initiated by changing the DUAL SW input pin from low to high level (set toggle switch).
2. After the DUAL STAT pin has changed the state from high level to low level, the Command state is active and the DUAL SW input pin can be reset from high level to low level (reset toggle).
3. The HOST is now able to send commands. After the commands have been sent, it is recommended to change back to Binary state by toggling the DUAL SW input pin again.

Bus and Control Timing Diagram

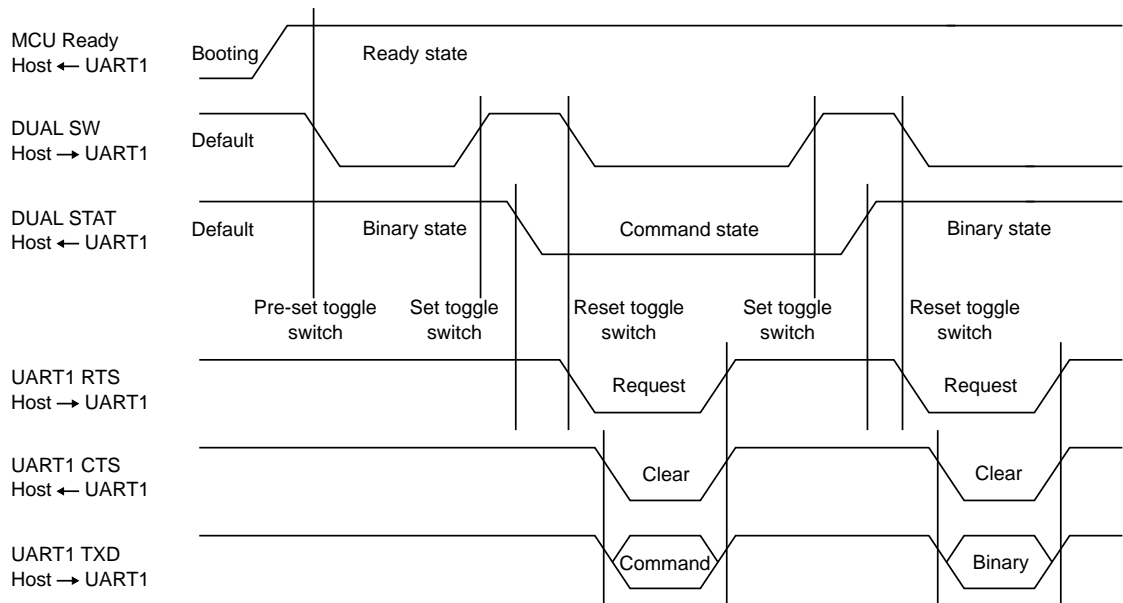

4.3.8 Peripheral Interface Specification



The Peripheral Interface pins are powered from the V_{IO} voltage supply internally connected to $V_{DD} = 3.3\text{ V}$.

DC specification ⇒ [4.3.1 Digital Pin Characteristics](#).

Configurable GPIOs

GPIO function	State	GPIO Pin Name					
		GPIO4	GPIO5	GPIO46	GPIO47	GPIO 48	GPIO 49
Input IN	-	YES	YES	YES	YES	YES	YES
Output OUT	ON	YES	YES	YES	YES	YES	YES
	OFF	YES	YES	YES	YES	YES	YES
Default by firmware	OFF	OUT	OUT	OUT	OUT	OUT	OUT

The functions of the configurable GPIOs are set by the firmware Default Config, but they can be reconfigured by using the HOST command interface (UART).

Firmware-Defined GPIOs

GPIO Pin Name	GPIO Definition		GPIO Level		Firmware State		
	Input	Output	Default	Active	Boot	Firmware Application Active	Firmware Function
STAT LED1	NO	YES	-	LOW	ON	OFF: Shut-off BLINK (1sec): Firmware active	MCU status (heartbeat)
STAT LED2	NO	YES	-	LOW	OFF	OFF: no IP assigned ON: IP assigned	IP-Connectivity in Infrastructure mode
STAT LED3	NO	YES	-	LOW	OFF	OFF: no error ON: error appeared	MCU firmware error
W STAT LED	NO	YES	-	LOW	OFF	OFF: no AP connection BLINK (0.2 s): Scanning for AP BLINK (0.4 s): trying to connect to AP BLINK (1.2 s): WLAN Error ON: Associated with AP	WLAN connectivity in Infrastructure mode
MCU READY	NO	YES	-	HIGH	OFF	OFF: Shut-off ON: Firmware ready	Firmware application is ready
FACTORY RESET	YES	NO	LOW ¹⁰	HIGH	inactive	Set active for min. 10 seconds	Restore firmware default
WAKE UP0	YES	NO	LOW ¹⁰	HIGH	inactive	Set active for min. 100 ms	Wake up after shut-off
WAKE UP1	YES	NO	LOW ¹⁰	HIGH	inactive	Set active for min. 100 ms	Wake up after shut-off

The functions of the firmware-defined GPIOs are fixed and cannot be changed.

¹⁰ Set default level by using resistor with 10 k Ohm to GND

4.4 RF Electrical Characteristics

4.4.1 WLAN Radio Specification

Parameter	Operation Mode				Specification
Standard Conformance	IEEE 802.11/IEEE 802.11b				
	IEEE 802.11g				
	IEEE 802.11n				
Modulation	IEEE 802.11b				DSSS/CCK
	IEEE 802.11g				OFDM
	IEEE 802.11n				OFDM @ MCS0-7
Physical layer data rates	IEEE 802.11				1, 2 Mbps @ DSSS
	IEEE 802.11b				5.5, 11 Mbps @ DSSS / CCK
Supported data rates	IEEE 802.11g				6, 9, 12, 18, 24, 36, 48, 54 Mbps
	IEEE 802.11n	MCS0-7	HT20	LGI	6.5, 13, 19.5, 26, 39, 52, 58.5, 65 Mbps
				SGI	7.2, 14.4, 21.7, 28.9, 43.3, 57.8, 65, 72.2 Mbps
Supported bandwidth	IEEE 802.11n				20 MHz (BW)
Supported Guard Interval	IEEE 802.11n				400 ns (SGI), 800 ns (LGI)
Supported channel 2.4GHz ¹¹	IEEE 802.11 b/g/n	North America (US)			1, 2, 3, 4, 5, 6, 7, 8, 9, 10, 11
		Canada (CA)			1, 2, 3, 4, 5, 6, 7, 8, 9, 10, 11
		Europe (EU)			1, 2, 3, 4, 5, 6, 7, 8, 9, 10, 11, 12, 13

¹¹ In order to comply with the relevant regulatory requirements, please refer to the model's supported channels ⇒ [7.1 Ordering Information](#).

4.4.2 WLAN RF Characteristics

4.4.2.1 RF Characteristics for IEEE 802.11b



Assume $V_{DD} = 3.3\text{ V}$, $T_{amb} = 25\text{ °C}$, if nothing else stated.

50 Ohm terminal load connected to the RF connector.

Parameter	Condition	Min.	Typ.	Max.	Units	
RF frequency range		2 400		2 483.5	MHz	
Carrier frequency tolerance		-25		+25	ppm	
Transmit output power			+16	+18	dBm	
Spectrum mask	$f_c \pm 11\text{ MHz}$			-30	dBr	
	$f_c \pm 22\text{ MHz}$			-50		
Power-on/Power-down ramp				2	μs	
RF Carrier suppression				-15	dB	
Error Vector Magnitude (EVM)	Peak			35	%	
Minimum Receive Sensitivity	1 Mbps (DSSS)	$\text{FER} \leq 8\%$		-97	-86	dBm
	2 Mbps (DSSS)	$\text{FER} \leq 8\%$		-94	-83	dBm
	5.5 Mbps (CCK)	$\text{FER} \leq 8\%$		-91	-79	dBm
	11 Mbps (CCK)	$\text{FER} \leq 8\%$		-88	-76	dBm
Maximum Input Level		$\text{FER} \leq 8\%$	-10		dBm	
Adjacent Channel Rejection		$\text{FER} \leq 8\%$	35		dB	

4.4.2.2 RF Characteristics for IEEE 802.11g

 Assume $V_{DD} = 3.3\text{ V}$, $T_{amb} = 25\text{ }^{\circ}\text{C}$, if nothing else stated.
50 Ohm terminal load connected to the RF connector.

Parameter	Condition	Min.	Typ.	Max.	Units	
RF frequency range		2 400		2 483.5	MHz	
Carrier frequency tolerance		-25		+25	ppm	
Transmit output power	6 Mbps ~ 54 Mbps		+14	+16	dBm	
Spectrum mask	$f_c \pm 11\text{ MHz}$			-20	dBr	
	$f_c \pm 20\text{ MHz}$			-28	dBr	
	$f_c \pm 30\text{ MHz}$			-40	dBr	
Transmitter center frequency leakage				-15	dB	
Transmitter Spectral Flatness		-2		+2	dB	
Constellation Error (EVM)	BPSK, CR 1/2 (6 Mbps)			-5	dB	
	BPSK, CR 3/4 (9 Mbps)			-8	dB	
	QPSK, CR 1/2 (12 Mbps)			-10	dB	
	QPSK, CR 3/4 (18 Mbps)			-13	dB	
	16-QAM, CR 1/2 (24 Mbps)			-16	dB	
	16-QAM, CR 3/4 (36 Mbps)			-19	dB	
	64-QAM, CR 2/3 (48 Mbps)			-22	dB	
	64-QAM, CR 3/4 (54 Mbps)			-25	dB	
Minimum Receive Sensitivity	BPSK, CR 1/2 (6 Mbps)	PER $\leq 10\%$		-90	-82	dBm
	BPSK, CR 3/4 (9 Mbps)	PER $\leq 10\%$		-89	-81	dBm
	QPSK, CR 1/2 (12 Mbps)	PER $\leq 10\%$		-87	-79	dBm
	QPSK, CR 3/4 (18 Mbps)	PER $\leq 10\%$		-85	-77	dBm
	16-QAM, CR 1/2 (24 Mbps)	PER $\leq 10\%$		-82	-74	dBm
	16-QAM, CR 3/4 (36 Mbps)	PER $\leq 10\%$		-79	-70	dBm
	64-QAM, CR 2/3 (48 Mbps)	PER $\leq 10\%$		-75	-66	dBm
	64-QAM, CR 3/4 (54 Mbps)	PER $\leq 10\%$		-73	-65	dBm
Maximum Input Level	PER $\leq 10\%$			-20	dBm	
Adjacent channel rejection	BPSK, CR 1/2 (6 Mbps)	PER $\leq 10\%$	16		dB	
	64-QAM, CR 3/4 (54 Mbps)	PER $\leq 10\%$	-1		dB	

4.4.2.3 RF Characteristics for IEEE 802.11n (BW 20 MHz)

 Assume $V_{DD} = 3.3\text{ V}$, $T_{amb} = 25\text{ }^{\circ}\text{C}$, if nothing else stated.
50 Ohm terminal load connected to the RF connector.

Parameter	Condition	Min.	Typ.	Max.	Units
RF frequency range		2 400		2 483.5	MHz
Carrier frequency tolerance		-25		+25	ppm
Transmit output power	MCS0 ~ MCS4		+14	+16	dBm
	MCS5 ~ MCS7		+13	+15	dBm
Spectrum mask	$f_c \pm 11\text{ MHz}$			-20	dBr
	$f_c \pm 20\text{ MHz}$			-28	dBr
	$f_c \pm 30\text{ MHz}$			-45	dBr
Transmitter center frequency leakage				-15	dB
Transmitter Spectral Flatness		-2		+2	dB
Constellation Error (EVM)	BPSK, CR 1/2 (MCS0)			-5	dB
	QPSK, CR 1/2 (MCS1)			-10	dB
	QPSK, CR 3/4 (MCS2)			-13	dB
	16-QAM, CR 1/2 (MCS3)			-16	dB
	16-QAM, CR 3/4 (MCS4)			-19	dB
	64-QAM, CR 2/3 (MCS5)			-22	dB
	64-QAM, CR 3/4 (MCS6)			-25	dB
	64-QAM, CR 5/6 (MCS7)			-27	dB
Minimum Receive Sensitivity ¹²	6.5 Mbps (MCS0)	PER ≤ 10 %	-90	-82	dBm
	13 Mbps (MCS1)	PER ≤ 10 %	-87	-79	dBm
	19.5 Mbps (MCS2)	PER ≤ 10 %	-85	-77	dBm
	26 Mbps (MCS3)	PER ≤ 10 %	-82	-74	dBm
	39 Mbps (MCS4)	PER ≤ 10 %	-79	-70	dBm
	52 Mbps (MCS5)	PER ≤ 10 %	-75	-66	dBm
	58.5 Mbps (MCS6)	PER ≤ 10 %	-73	-65	dBm
	65 Mbps (MCS7)	PER ≤ 10 %	-72	-64	dBm
Maximum Input Level	PER ≤ 10 %			-20	dBm
Adjacent channel rejection ¹³	65 Mbps (MCS7)	PER ≤ 10 %	-2		dB

¹² The Minimum Sensitivity levels apply only to non-STBC modes, MCS 0~7, 800 ns LGI and BCC.

¹³ The Adjacent Channel Rejection levels apply only to non-STBC modes, MCS 0~7, 800 ns LGI and BCC.

4.5 Reliability Tests

The measurement should be done after the test device has been exposed to room temperature and humidity for one hour.

No.	Item	Limit	Condition
1	Vibration test	Electrical parameter should be in specification	Freq.: 20~2 000 Hz; 17g~50g /cycle, 2 hrs. each of XYZ axis
2	Shock test	the same as above	Dropped onto concrete from a height of 1 m for 3 times
3	Heat shock cycle test	the same as above	-50 °C for 30 min. and +125 °C for 300 cycles each 15 min.
4	Temperature humidity bias test (THB)	the same as above	+85 °C, 85 % RH, 500 h
5	Low temp. storage test (LTST)	the same as above	-40 °C, 300 h
6	High temp. storage test (HTST)	the same as above	+85 °C, 300 h

4.6 Recommended Soldering Profile



- Reflow permissible cycle: 2
- Opposite side reflow is prohibited due to module weight
- More than 75 percent of the soldering area shall be coated by solder
- The soldering profiles should be adhered to in order to prevent electrical or mechanical damage
- Soldering profile assumes lead-free soldering

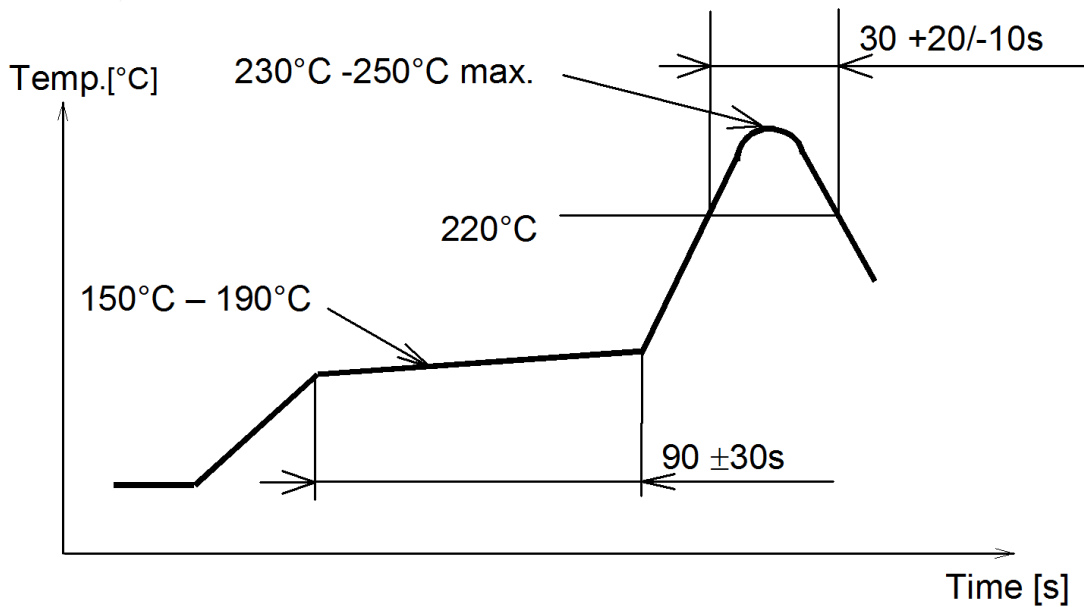

5 Cautions



Failure to follow the guidelines set forth in this document may result in degrading of the product's functions and damage to the product.

5.1 Design Notes

1. Follow the conditions written in this specification, especially the control signals of this module.
2. The supply voltage must be free of AC ripple voltage (for example from a battery or a low noise regulator output). For noisy supply voltages, provide a decoupling circuit (for example a ferrite in series connection and a bypass capacitor to ground of at least 47 μ F directly at the module).
3. This product should not be mechanically stressed when installed.
4. Keep this product away from heat. Heat is the major cause of decreasing the life of these products.
5. Avoid assembly and use of the target equipment in conditions where the product's temperature may exceed the maximum tolerance.
6. The supply voltage should not be exceedingly high or reversed. It should not carry noise and/or spikes.
7. Keep this product away from other high frequency circuits.
8. Refer to the recommended pattern when designing a board.

5.2 Installation Notes

1. Reflow soldering is possible twice based on the conditions in [⇒ 4.6 Recommended Soldering Profile](#). Set up the temperature at the soldering portion of this product according to this reflow profile.
2. Carefully position the products so that their heat will not burn into printed circuit boards or affect the other components that are susceptible to heat.
3. Carefully locate these products so that their temperatures will not increase due to the effects of heat generated by neighboring components.
4. If a vinyl-covered wire comes into contact with the products, then the cover will melt and generate toxic gas, damaging the insulation. Never allow contact between the cover and these products to occur.
5. This product should not be mechanically stressed or vibrated when reflowed.
6. To repair the board by hand soldering, follow the conditions set forth in this chapter.
7. Do not wash this product.
8. Pressing on parts of the metal cover or fastening objects to the metal will cause damage to the unit.

5.3 Usage Condition Notes

1. Take measures to protect the unit against static electricity.
If pulses or other transient loads (a large load applied in a short time) are applied to the products, check and evaluate their operation before assembly on the final products.
2. Do not use dropped products.
3. Do not touch, damage or soil the pins.
4. Follow the recommended condition ratings about the power supply applied to this product.
5. Electrode peeling strength: Do not add pressure of more than 4.9 N when soldered on PCB.
6. Pressing on parts of the metal cover or fastening objects to the metal cover will cause damage.
7. These products are intended for general purpose and standard use in general electronic equipment, such as home appliances, office equipment, information, and communication equipment.

5.4 Storage Notes

1. The module should not be stressed mechanically during storage.
2. Do not store these products in the following conditions or the performance characteristics of the product, such as RF performance will be adversely affected:
 - Storage in salty air or in an environment with a high concentration of corrosive gas, such as Cl₂, H₂S, NH₃, SO₂, or NO_x,
 - Storage in direct sunlight,
 - Storage in an environment where the temperature may be outside the range of 5 °C to 35 °C, or where the humidity may be outside the 45 to 85 percent range,
 - Storage of the products for more than one year after the date of delivery storage period: Please check the adhesive strength of the embossed tape and soldering after 6 months of storage.
3. Keep this product away from water, poisonous gas, and corrosive gas.
4. This product should not be stressed or shocked when transported.
5. Follow the specification when stacking packed crates (max. 10).

5.5 Safety Cautions

These specifications are intended to preserve the quality assurance of products and individual components.

Before use, check and evaluate the operation when mounted on your products. Abide by these specifications without deviation when using the products. These products may short-circuit. If electrical shocks, smoke, fire, and/or accidents involving human life are anticipated when a short circuit occurs, provide the following failsafe functions as a minimum:

1. Ensure the safety of the whole system by installing a protection circuit and a protection device.
2. Ensure the safety of the whole system by installing a redundant circuit or another system to prevent a single fault causing an unsafe status.

5.6 Other Cautions

1. Do not use the products for other purposes than those listed.
2. Be sure to provide an appropriate fail-safe function on your product to prevent an additional damage that may be caused by the abnormal function or the failure of the product.
3. This product has been manufactured without any ozone chemical controlled under the Montreal Protocol.
4. These products are not intended for uses other than under the special conditions shown below. Before using these products under such special conditions, carefully check their performance and reliability under the said special conditions to determine whether or not they can be used in such a manner:
 - In liquid, such as water, salt water, oil, alkali, or organic solvent, or in places where liquid may splash,
 - In direct sunlight, outdoors, or in a dusty environment,
 - In an environment where condensation occurs,
 - In an environment with a high concentration of harmful gas (e. g. salty air, HCl, Cl₂, SO₂, H₂S, NH₃, and NO_x).
5. If an abnormal voltage is applied due to a problem occurring in other components or circuits, replace these products with new products because they may not be able to provide normal performance even if their electronic characteristics and appearances appear satisfactory.
6. When you have any question or uncertainty, contact Panasonic.

5.7 Life Support Policy

This Panasonic Industrial Devices Europe GmbH product is not designed for use in life support appliances, devices, or systems where malfunction can reasonably be expected to result in a significant personal injury to the user, or as a critical component in any life support device or system whose failure to perform can be reasonably expected to cause the failure of the life support device or system, or to affect its safety or effectiveness.

Customers using or selling these products for use in such applications do so at their own risk and agree to fully indemnify Panasonic Industrial Devices Europe GmbH for any damages resulting.

6 Regulatory and Certification Information

6.1 Federal Communications Commission (FCC) for US

6.1.1 FCC Notice



The PAN9420, including the ceramic antenna (ENW49C01A3KF), and including the antennas, which are listed in [⇒ 6.1.5 Approved Antenna List](#), complies with Part 15 of the FCC Rules.

The device meets the requirements for modular transmitter approval as detailed in FCC public Notice DA00-1407. The transmitter operation is subject to the following two conditions:

1. This device may not cause harmful interference, and
2. This device must accept any interference received, including interference that may cause undesired operation.

The FCC identifier for ENW49C01A3KF is **FCC ID: T7V-9420**.

6.1.2 Caution



The FCC requires the user to be notified that any changes or modifications made to this device that are not expressly approved by Panasonic Industrial Devices Europe GmbH may void the user's authority to operate the equipment.



This equipment has been tested and found to comply with the limits for a Class B digital device, pursuant to Part 15 of the FCC Rules.

These limits are designed to provide reasonable protection against harmful interference in a residential installation. This equipment generates uses and can radiate radio frequency energy and, if not installed and used in accordance with the instructions, may cause harmful interference to radio communications.

However, there is no guarantee that interference will not occur in a particular installation. If this equipment does cause harmful interference to radio or television reception, which can be determined by turning the equipment off and on, the user is encouraged to try to correct the interference by one or more of the following measures:

- Reorient or relocate the receiving antenna.
- Increase the separation between the equipment and receiver.
- Connect the equipment into an outlet on a circuit different from that to which the receiver is connected.
- Consult the dealer or an experienced radio/TV technician for help

6.1.3 Label Requirements



The OEM must ensure that FCC labelling requirements are met. This includes a clearly visible label (laser marking) on the outside of the OEM enclosure specifying the appropriate Panasonic FCC identifier for this product as well as the FCC Notice above.

The FCC identifier is **FCC ID: T7V-9420** for model ENW49C01A3KF.

This FCC identifier is valid for the PAN9420. The end product must in any case be labelled on the exterior with:

“Contains FCC ID: T7V-9420”.

6.1.4 Antenna Warning

This antenna warning refers to the test device with the model number ENW49C01A3KF in bottom pad mode ⇒ [Chapter 4.3.2 Module Selectable RF-In/Output](#).

The device is tested with a standard SMA connector and with the antenna listed below. When integrated into the OEM’s product, these fixed antennas require installation preventing end users from replacing them with non-approved antennas. Any antenna not in the following table must be tested to comply with FCC Section 15.203 for unique antenna connectors and with Section 15.247 for emissions. The FCC identifier for the device with the antenna listed in ⇒ [6.1.5 Approved Antenna List](#) is the same (**FCC ID: T7V-9420**).

6.1.5 Approved Antenna List

Item	Part Number	Manufacturer	Frequency Band	Type	Gain (dBi)
1	ANT2012LL13R2400A	Yageo	2.4 GHz	Chip antenna	+0.8

Note: We are able to qualify your antenna and will add it to this list when the certification process is completed.

6.1.6 RF Exposure



To comply with FCC RF Exposure requirements, the OEM must ensure that only antennas from the Approved Antenna List are installed ⇒ [6.1.5 Approved Antenna List](#).

The preceding statement must be included as a CAUTION statement in manuals for products operating with the approved antennas in the previous table to alert users on FCC RF Exposure compliance.

Any notification to the end user of installation or removal instructions about the integrated radio module is not allowed.

The radiated output power of the PAN9420 with a mounted ceramic chip antenna (**FCC ID: T7V-9420** for model ENW49C01A3KF) are fulfilled for mobile configuration. The installation of the module is restricted to mobile host devices. Nevertheless, the PAN9420 shall be used in such a manner that the potential for human contact during normal operation is minimized.

End users may not be provided with the module installation instructions. OEM integrators and end users must be provided with transmitter operating conditions for satisfying RF exposure compliance.

6.2 Innovation, Science, and Economic Development (ISED) for Canada

English

PAN9420 and versions are licensed to meet the regulatory requirements of ISED.

License for M/N: ENW49C01A3KF: **IC: 216Q-9420**

License for M/N: ENW49C02A3KF: **IC: 216Q-9420**

Manufacturers of mobile, fixed, or portable devices incorporating this module are advised to clarify any regulatory questions and ensure compliance for SAR and/or RF exposure limits. Users can obtain Canadian information on RF exposure and compliance from www.ic.gc.ca.

This device has been designed to operate with the antennas listed in ⇒ [6.1.5 Approved Antenna List](#), having a maximum gain of +0.8 dBi. Antennas not included in this list or having a gain greater than +0.8 dBi are strictly prohibited for use with this device. The required antenna impedance is 50 Ohm. The antenna used for this transmitter must not be co-located or operating in conjunction with any other antenna or transmitter.

Due to the model size, the IC identifier is displayed in the installation instruction only and it cannot be displayed on the module's label due to the limited size.

French

PAN9420 (et ses versions) est garanti conforme aux dispositions réglementaires d'Innovation, Sciences et Développement économique (ISDE).

Licence pour M/N: ENW49C01A3KF: **IC: 216Q-9420**

Licence pour M/N: ENW49C02A3KF: **IC: 216Q-9420**

Il est recommandé aux fabricants d'appareils fixes, mobiles ou portables de consulter la réglementation en vigueur et de vérifier la conformité de leurs produits relativement aux limites d'exposition aux rayonnements radiofréquence ainsi qu'au débit d'absorption spécifique maximum autorisé.

Des informations pour les utilisateurs sur la réglementation Canadienne concernant l'exposition aux rayonnements RF sont disponibles sur le site www.ic.gc.ca.

Ce produit a été développé pour fonctionner spécifiquement avec les antennes listées dans le tableau ⇒ [6.1.5 Approved Antenna List](#), présentant un gain maximum de 0.8 dBi. Des antennes autres que celles listées ici, ou présentant un gain supérieur à 0.8 dBi ne doivent en aucune circonstance être utilisées en combinaison avec ce produit. L'impédance des antennes compatibles est 50 Ohm. L'antenne utilisée avec ce produit ne doit ni être située à proximité d'une autre antenne ou d'un autre émetteur, ni être utilisée conjointement avec une autre antenne ou un autre émetteur.

En raison de la taille du produit, l'identifiant IC est fourni dans le manuel d'installation.

6.2.1 IC Notice

English



The device PAN9420 and versions (⇒ [7.1 Ordering Information](#)), including the antennas (⇒ [6.1.5 Approved Antenna List](#)), comply with Canada RSS-GEN Rules. The device meets the requirements for modular transmitter approval as detailed in RSS-Gen.

Operation is subject to the following two conditions:

1. This device may not cause harmful interference, and
2. This device must accept any interference received, including interference that may cause undesired operation.

French



Le présent appareil PAN9420 (⇒ [7.1 Ordering Information](#)), les antennes y compris (⇒ [6.1.5 Approved Antenna List](#)), est conforme aux CNR-Gen d'ISDE applicables aux appareils radio exempts de licence.

L'exploitation est autorisée aux deux conditions suivantes :

1. l'appareil ne doit pas produire de brouillage, et
2. l'utilisateur de l'appareil doit accepter tout brouillage radioélectrique subi, même si le brouillage est susceptible d'en compromettre le fonctionnement.

6.2.2 Labeling Requirements

English



Labeling Requirements

The OEM must ensure that IC labelling requirements are met. This includes a clearly visible label on the outside of the OEM enclosure specifying the appropriate Panasonic IC identifier for this product as well as the IC Notice above.

The IC identifiers are:

IC: 216Q-9420 (for M/N: ENW49C01A3KF)

IC: 216Q-9420 (for M/N: ENW49C02A3KF)

These IC identifiers are valid for all PAN9420 modules ⇒ [7.1 Ordering Information](#). In any case, the end product must be labelled on the exterior with:

“Contains IC: 216Q-9420”

French



Obligations d'étiquetage

Les fabricants d'équipements d'origine (FEO) – en anglais Original Equipment Manufacturer (OEM) – doivent s'assurer que les obligations d'étiquetage IC du produit final sont remplies. Ces obligations incluent une étiquette clairement visible à l'extérieur de l'emballage externe, comportant l'identifiant IC du module Panasonic inclus, ainsi que la notification ci-dessus.

L'identifiant IC est:

IC: 216Q-9420 (pour M/N: ENW49C01A3KF)

IC: 216Q-9420 (pour M/N: ENW49C02A3KF)

Cet identifiant est valide pour tous les modules PAN9420 ⇒ [7.1 Ordering Information](#). Dans tous les cas les produits finaux doivent indiquer sur leur emballage externe la mention suivante:

“Contient IC: 216Q-9420”

6.3 European Conformity According to RED (2014/53/EU)

All modules described in this product specification comply with the standards according to the following LVD (2014/35/EU), EMC-D (2014/30/EU) together with RED (2014/53/EU) articles:

3.1a Safety/Health:	EN60950-1:2006+A11:2009+A1:2010+A12:2011+AC:2011+A2:2013 EN62311:2008
3.1b EMC:	EN 301 489-1 V2.1.1:2017-02 EN 301 489-17 V3.1.1:2017-02
3.2 Radio:	EN 300 328 V2.1.1:2016-11

As a result of the conformity assessment procedure described in 2014/53/EU Directive, the end customer equipment should be labelled as follows:



The end customer has to assure that the device has a distance of more than 20 cm from the human body under all circumstances.

The end customer equipment must meet the actual Safety/Health requirements according to RED.

PAN9420 and its model versions in the specified reference design can be used in all countries of the European Economic Area (Member States of the EU, European Free Trade Association States[Iceland, Liechtenstein, Norway]), Monaco, San Marino, Andorra, and Turkey.

6.4 RoHS and REACH Declaration

The latest declaration of environmental compatibility (Restriction of Hazardous Substances, RoHS and Registration, Evaluation, Authorisation and Restriction of Chemicals, REACH) for supplied products can be found on the Panasonic website in the “Downloads” section of the respective product ⇒ [7.2.2 Product Information](#).

7 Appendix

7.1 Ordering Information

Variants and Versions

Order Number	Brand Name	Description	MOQ ¹⁴
ENW49C01A3KF	PAN9420 ¹⁵	Fully embedded stand-alone Wi-Fi module IEEE 802.11 b/g/n Regulatory notice: FCC/IC ¹⁶ for US and for Canada Supported channel: Channel 1 ~ 11, 2412 ~ 2462 MHz	500
ENW49C02A3KF	PAN9420 ¹⁵	Fully embedded stand-alone Wi-Fi module IEEE 802.11 b/g/n Regulatory notice: ETSI ¹⁷ for EU and other Supported channel: Channel 1 ~ 13, 2412 ~ 2472 MHz	500

The PAN9420 is delivered with a pre-installed firmware. For further information please refer to our product documentation ⇒ [7.2.2 Product Information](#).

¹⁴ Abbreviation for Minimum Order Quantity (MOQ). The standard MOQ for mass production is 500 pieces, fewer only on customer demand. Samples for evaluation can be delivered at any quantity via the distribution channels.

¹⁵ The Grant IDs marked on the module labelling are referenced and only valid if the ceramic on-board chip antenna on module is used.

¹⁶ The model with the Regulatory Domain FCC/IC (M/N: ENW49C01A3KF) is only intended to be used in the countries of US and Canada because only the channels 1 ~ 11 (2412 ~ 2462 MHz) are supported in the 2.4 GHz ISM band. It is not possible to change the pre-stored Region Code in order to change the Regulatory Domain. Thus the module labeling contains the FCC Grant ID.

¹⁷ The model with Regulatory Domain ETSI (M/N: ENW49C02A3KF) is mainly intended to be used in European countries because the channels 1 ~ 13 (2412 ~ 2472 MHz) are supported. The Region Code is pre-configured (using Default Config Content in Flash memory) to Regulatory Domain ETSI and thus the module labeling does not contain the FCC ID. At the end the customer is able to change applied Region Code by his own Customer Config Content to be stored during customer OEMs product production in the flash memory. It means the FCC Regulatory Domain can be configured as well, but the customer has to certify the end product by himself.

7.2 Contact Details

7.2.1 Contact Us

Please contact your local Panasonic Sales office for details on additional product options and services:

For Panasonic Sales assistance in the **EU**, visit

<https://eu.industrial.panasonic.com/about-us/contact-us>

Email: wireless@eu.panasonic.com

For Panasonic Sales assistance in **North America**, visit the Panasonic Sales & Support Tool to find assistance near you at

<https://na.industrial.panasonic.com/distributors>

Please visit the **Panasonic Wireless Technical Forum** to submit a question at

<https://forum.na.industrial.panasonic.com>

7.2.2 Product Information

Please refer to the Panasonic Wireless Connectivity website for further information on our products and related documents:

For complete Panasonic product details in the **EU**, visit

<http://pideu.panasonic.de/products/wireless-modules.html>

For complete Panasonic product details in **North America**, visit

<http://www.panasonic.com/rfmodules>